

THE PRODUCTION OF FIBRES FROM CHITIN

A thesis submitted for the degree

of

Doctor of Philosophy

by

OCHAYI CHRISTOPHER ^{VC} AGBOH
2

An account of work carried out in the Department of
Textile Industries, the University of Leeds, under
the supervision of Dr. G. C. East.

Man-Made Fibres Division,
Department of Textile Industries,
University of Leeds,
Leeds LS2 9JT.

September 1986

Thesis.

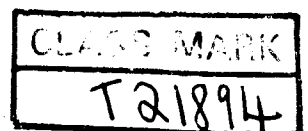

BEST COPY AVAILABLE.

VARIABLE PRINT QUALITY

TO MY FAMILY

ACKNOWLEDGEMENTS

It gives me great pleasure to express my profound gratitude to Dr. G.C. East for his continued interest, help, guidance and encouragement throughout this work. I also wish to thank Professor J.E. McIntyre for his keen interest in the work.

I would like also to thank the Overseas Research Students (O.R.S.) Awards Scheme Committee and the British Council for the partial fees awarded. I am particularly indebted to the Federal and Benue state governments of Nigeria for the scholarship awards between 1981 and 1983. I gratefully acknowledge the financial assistance by the Textile Department.

My appreciation is also due to:

Mrs. B. McClelland for much help and valuable advice.

Mr. D.F. Storer for his assistance with fibre extrusion.

Textile Physics for taking the scanning electron micrographs and X-ray diffraction photographs.

Dr. D.J. Johnson for the interpretation of the X-ray diffraction patterns.

Dr. J.G. Tomka for valuable suggestions for the interpretation of the rheological data.

Mr. L. Johnson for assistance with the measurement of the DSC and TGA analyses.

Finally, I wish to thank Mrs. S. McOwat for her speed and efficiency in typing the manuscript.

SPECIAL THANKS

I wish to offer my most sincere thanks to my wife, whose endurance and hard work provided the only means and incentive that made this work possible.

ABSTRACT

Wet spinning and dry-jet wet-spinning processes for the production of fibres from chitin have been developed. In preparing such fibres, it was found to be advantageous to first depolymerize the chitin using a pretreatment with p-toluene sulphonic acid in isopropanol. The chitin obtained after this treatment was characterised and the molecular weight was estimated to have fallen from 2×10^6 to 1.5×10^5 . Otherwise, it was chemically similar to the original chitin. Thereafter, high viscosity spinning solutions were prepared by dissolving the polymer (5-9%, w/w) in a solvent system comprising dimethyl acetamide (DMA) and lithium chloride. After ageing the solution for about 7 days, it was extruded from spinnerets of hole diameter 50-150 μm (wet spinning) and 150-400 μm (dry-jet wet-spinning) into a wide variety of coagulation baths, most of which allowed the production of continuous but highly swollen filaments. The best coagulation conditions noted were those using 75:25 DMA:H₂O at temperatures 40-75°C, or methanol at room temperature.

Typical chitin fibres produced were 20-80 μm in diameter (4.4-70.0 dtex) and had tenacities of 0.7-2.2 g/dtex, initial moduli of 10-55 g/dtex, breaking toughness of 0.1-0.6 g.cm/dtex.cm and extensibilities of 7-75%. The effects of spinning conditions on spinnability and fibre properties indicated that spinnability improved with increasing coagulation bath temperature (for those baths that could be heated) and with addition of the right type of plasticizers to the spinning solution.

In attempting to compare the spinning solution with those of other polymers, the rheological properties of the solutions were studied.

Such studies indicated that the viscosity of the solution was Newtonian at low shear rates and was proportional to the fourth power of concentration. The change in viscosity with temperature was related to an Andrade type equation and an apparent activation energy for viscous flow of approximately 40 KJmol^{-1} was found.

CONTENTS

	<u>Page</u>
1. INTRODUCTION	1
1.1 Historical background	2
1.2 Occurrence of chitin	3
1.3 The chemical structure of chitin	7
1.4 The crystal structure of chitin	11
1.5 The chitin-protein complex	24
1.6 Recovery of chitin	29
1.7 Reduction of molecular weight of chitin	30
1.8 Chitin derivatives	33
1.9 Preparation of fibres and films from chitin	35
1.10 Fibre production from chitin derivatives	56
1.11 Aims of the study	63
2. MATERIALS AND GENERAL EXPERIMENTAL METHODS	64
2.1 Materials	65
2.2 Characterisation of chitin	65
2.2.1 Solubility	65
2.2.2 Solution viscosity measurement	67
2.2.3 Infrared spectroscopy	69
2.2.4 Optical activity	70
2.2.5 Measurement of the acetyl content	71
2.2.6 Measurement of the moisture content	73
2.2.7 Thermal analysis	73
2.2.8 Elemental analysis	73
2.2.9 Solution characterisation by viscosity measurement	76
2.2.10 Purification/depolymerisation of chitin	77
2.3 The spinning apparatus	78
2.3.1 The main filtration unit	78
2.3.2 Extrusion unit	81
2.3.3 The coagulation bath	85
2.3.4 The stretching bath and advancing reels	88

CHAPTER 2 continued	<u>Page</u>
2.3.5 The drying unit	90
2.3.6 Winding unit	92
2.4 Fibre production	92
2.4.1 Preparation of the spinning dope	92
2.4.2 Linear rate of extrusion	95
2.4.3 Maximum draw ratio	97
2.4.4 Spinning procedures	98
2.5 Fibre characterisation	104
2.5.1 Determination of tensile properties	104
2.5.2 Fibre density determination	106
2.5.3 Fibre diameter	107
2.5.4 Linear density	107
2.5.5 Surface characteristics	109
2.5.6 X-ray diffraction pattern	109
2.5.7 Moisture content and thermal analysis	109
3. PRELIMINARY STUDIES OF THE SPINNING OF CHITIN FIBRES	111
3.1 Initial comments	112
3.2 Results and discussion	112
3.2.1 Effect of ageing on dope	115
3.2.2 Studies of the effect of coagulation variables on fibre properties	122
3.2.2.1 Effect of bath composition	124
3.2.2.2 Studies on the effect of washing on fibre properties	136
3.2.2.3 Effect of dope temperature and drying on chrome rollers (under tension) on fibre properties	145
3.2.2.4 Effect of dope concentration	151
3.2.3 Effect of jet stretch ratio	154
3.2.4 Comparison of various coagulants using a typical wet spinning spinneret	165

	<u>Page</u>
4. CHARACTERISATION OF CHITIN SAMPLES	175
4.1 Results and discussion	176
4.1.1 Examination of chitin solubility in different solvents	176
4.1.2 Dilute solution viscosity measurements	178
4.1.3 Infrared spectroscopy	185
4.1.4 Elemental analysis and acetyl content values	188
4.1.5 Optical activity	193
4.1.6 Thermal analysis	195
4.1.7 Viscosity of concentrated solutions of chitin	199
5. CHARACTERISATION OF SPINNING DOPES BY VISCOSITY MEASUREMENT	217
5.1 Introduction	218
5.2 Experimental	224
5.3 Results	224
5.4 Discussion	239
5.4.1 Effect of LiCl concentration	239
5.4.2 Effect of dope concentration	241
5.4.3 Effect of temperature	244
5.4.4 Effect of shear rate	247
6. ASSESSMENT OF COAGULATION BEHAVIOUR IN THE SPINNING OF CHITIN FIBRES	250
6.1 Introduction	251
6.2 Experimental	257
6.2.1 Measurement of gel swell factor (GSF)	257
6.2.2 Measurement of the extrudate diameters	260
6.2.3 Observation of coagulation modes using schlieren pattern	263
6.3 Results and discussion	264

	<u>Page</u>
7. THE DEVELOPMENT OF A SPINNING SYSTEM FOR THE PRODUCTION OF CHITIN FIBRES	280
7.1 Introduction	281
7.2 Experimental	282
7.2.1 Hydrolysis of chitin	282
7.2.2 Preparation of fibres	282
7.3 Results and discussion	282
7.3.1 Effect of tension on partially coagulated chitin fibres	282
7.3.2 Electron micrographs and X-ray diffraction patterns of undrawn relaxed chitin fibres	292
7.3.3 Study of the drawing operation	300
7.3.3.1 Wet spinning	301
7.3.3.2 Dry-jet wet-spinning	331
7.3.4 Electron micrographs of drawn fibres	348
7.3.5 X-ray diffraction patterns of drawn fibres	360
8. THE EFFECT OF ADDITION OF PLASTICIZERS TO THE DOPE	369
8.1 Introduction	370
8.2 Experimental	371
8.2.1 Materials	371
8.2.2 Preparation of chitin-plasticizer dope	371
8.2.3 Preparation of films and fibres	373
8.3 Results and discussion	375
8.3.1 General	375
8.3.2 Effect of addition of plasticizers to the dope	377
8.3.2.1 Effect on dope viscosity	377
8.3.2.2 Effect on fibre properties	379
8.3.2.3 Ultraviolet absorption spectra of plasticized chitin fibres	395
8.3.2.4 Electron micrographs of plasticized chitin fibres	397
8.3.3 Effect of addition of water to the dope	402

	<u>Page</u>
9. FINAL SUMMARY AND CONCLUSIONS	408
9.1 Dope preparation	409
9.2 Dope characterisation	411
9.3 The spinning process	413
9.4 Properties of chitin fibres	418
9.5 Suggestions for future work	434
APPENDIX 1	436
APPENDIX 2	441
REFERENCES	442

CHAPTER 1

INTRODUCTION

1.1 Historical background

The first man to write about chitin was Braconnot [1] in 1811, who obtained an alkali-resistant residue 'fungine' from his work on fungi. Although Braconnot was not sure what his 'fungine' was, he suspected that it contained nitrogen, and was therefore different from woody materials. Earlier, in 1799, Hatchett [2] had noticed a similar resistant organic material in his work on shells and bones, but unfortunately did not pursue it further. Later, in 1823, the name chitin (or chitine) was given to a similar material found by Odier [3] while studying insects. The name comes from the Greek word 'chiton' meaning tunic or 'coat of mail'. Like Braconnot, Odier was not able to detect nitrogen in his material. He concluded that the material was identical with the cuticle of plants.

In 1824, Odier's work was translated into English by Children [4] who observed that Odier's failure to detect nitrogen in his chitin could have been due to a simultaneous liberation of ammonia and acetic acid during distillation which would result in neutralization and prevent a positive detection of ammonia. Using a well purified chitin, Children repeated much of Odier's work and found nitrogen from the dry distillation of the residue. In 1843, Lassaigne [5] and Payen [6] confirmed the presence of nitrogen in insect chitin. By now, it had become obvious that chitin was present in fungi, arthropods and insects. However, although the presence of nitrogen had been confirmed, it was still believed by some of the workers that Braconnot's 'fungine' was cellulose. Fortunately, in 1876, Ledderhose [7] after several trials obtained a mixture of glucosamine and acetic acid on hydrolysis of arthropod chitin with concentrated hydrochloric acid. In 1894, Gilson [8] and Winterst

[9] established the chemical similarity between fungal and animal chitin through the isolation of glucosamine as a hydrolysis product of fungal chitin.

Subsequent studies (see section 1.3) showed that chitin was substantially poly- β - (1-4) linked N-acetyl-D-glucosamine (Fig. 1.1). A closely related polymer, chitosan, (Fig. 1.2) can be derived from chitin by hydrolysis and the overall similarity of both these polymers to cellulose is obvious (Fig. 1.3).

1.2 Occurrence of chitin

Chitin, like cellulose and collagen, is of very ancient origin. The evidence of its existence in the early stages of the evolution of organisms such as insects about twenty-five million years ago was demonstrated in the work by Abderhalden and Heyns [10].

Over the years the advancement of knowledge about chitin, though uneven, has shown that chitin does not occur in the tissues of vertebrates but is widely distributed in many species from bacteria through fungi to lower animals. The distribution of chitin has been reviewed by several authors [11-14], the most recent being that by Muzzarelli [14]. An extract of the review by Muzzarelli is given in Table 1.1. Chitin occurs primarily in the shells of crustaceans and insects, and to a lesser extent in plants and animals. Because of their apparent abundance, crustacea (crab, shrimp, prawn, lobster and crayfish) have been the main choice for commercial extraction of chitin. This is not all that surprising because large quantities of shellfish wastes are available from marine food industries which produce canned meat, crab meal and proteins. Chitin isolated from these sources is claimed to be

Structures of chitin, chitosan and cellulose

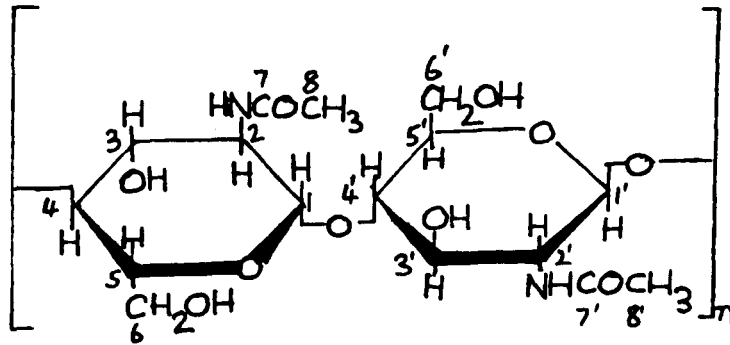

FIG. 1.1: The chitin (chitobiose) repeating unit

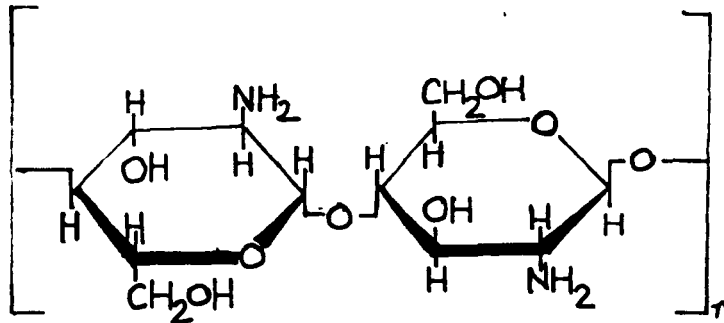

FIG. 1.2: The chitosan repeating unit

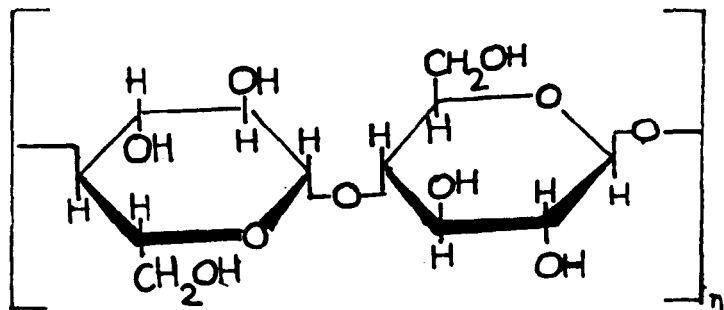

FIG. 1.3: The cellulose (cellobiose) repeating unit

better defined in composition than from other sources [15]. The regions of the world where crustacea are abundant includes U.S.A., India, Thailand, Malaysia, Philippines, South Africa and Mexico. To give an idea of the resources available, the wet waste from shrimp in Thailand rose from 60,000 tons/year in 1968 to 110,000 tons in 1976; prawn waste in India was 59,000 tons/year in 1976 and should be more now. As for the U.S.A., the total waste from crab and shrimp was estimated to be between 4,500-8,000 tons/year in 1976 [14].

Another potential source of chitin other than marine wastes is fungal waste. The chitin from here is, however, complexed with various other forms of polysaccharides (glucans) and perhaps proteins that may prove difficult or expensive to remove completely. The source, nevertheless, is promising, considering the large quantities of fungi currently grown in fermentation systems for the production of organic acids, antibiotics and enzymes [16]. One such process involves the production of citric acid which in 1973 was estimated to amount to 82×10^6 kg (90,000 tons), and it was estimated that the waste produced was of the order of tens of thousands tons [16]. The acid is manufactured from Aspergillus Niger whose cell wall contains about 42% chitin [16]. Other fungal species such as Mucor Rouxii, Phycomyces Blakesleeanus and Choanephora Cucurbitarun may also be of interest, but their cell walls have been found to contain more chitosan than chitin which may thus provide a convenient natural source of the deacetylated form of chitin [17].

Certain marine diatoms (Cyclotella Cryptica and Thalassiosira Fluviatilis) are believed to secrete filaments which contain the only recognised source of pure unassociated β -chitin found in nature [18]. The production of chitin from diatoms is at present only an interesting

TABLE 1.1: Distribution and chemical features of the diverse chitinous structures in living organisms [14]

Organisms	Examples	Structures	Minerals	Chitin (%)	Other organic constituents
FUNGI					
Ascomyceta	<i>Aspergillus flavus, niger</i>	Cell walls and structural membranes of mycelia stalks and spores		traces to 45	glucans, mannan or other polysaccharides
Phycomyceta	<i>Mucor rouxii, Phycomyces Blakesleanus</i>				
ALGAE					
Chlorophyceae	<i>Valonia ventricosa</i>			"	cellulose
ANNELIDA					
Polychaeta	<i>Aphrodite, Amphinome</i>	chaetae		20-38B	quinone-tanned proteins
MOLLUSCA					
Polyplacophora	chiton	shell plates	CaCO ₃	12	proteins
		radula	iron ₃ sil.	"	proteins
Gastropoda	<i>Helix pomatia</i>	radula		20α	tanned proteins
		jaw		"	" "
Cephalopoda	<i>Sepia officinalis, Loligo paelei, Octopus vulgaris</i>	calcified shell	CaCO ₃	3-26B	conchiolin
		pen		18B	conchagen
ARTHROPODA					
Crustacea	<i>Palinurus vulgaris, Homarus vulgaris, cancer magister, Pagurus, Astacus fluviatilis</i>	calcified cuticle	CaCO ₃	58-85α	arthropodin+sclerotin
		intersegmental membrane	CaCO ₃	48-80α	arthropodin
Insecta	<i>Locusta migratoria, Bombyx Mori, Drosophila melanogaster</i>	hardened cuticle		20-60α	arthropodin+sclerotin
		unhardened cuticle		20-60α	" "
Arachnida and Chilopoda	<i>Galeodes</i>	Peritrophic membrane		4-22	protein+mucin
POGONOPHORA	<i>Oligobrachia ivanovi</i>	tubes		33B	proteins
PROTOZOA					
Rhizopoda	<i>Pelomyxa</i>	Cyst wall		traces to 45	
	<i>Allogromia</i>	shell	iron	"	proteins, lipids

NB α and β refer to the different crystalline forms of chitin (section 1.4)

possibility because of uncertainties on the growth characteristics, the yield of chitin obtained and the cost of nutritional requirements of these organisms [16].

Production of chitin may also be feasible from insect sources, since most of them have chitinous exoskeletons. The chitin is associated with protein but free of calcium carbonate which means that the isolation may only involve simple alkaline extractions for protein removal. However, it is anticipated that production based on micro-organisms will be more viable in economic and technical terms than comparable operations based on insect farming [16].

Over the past decade, there has been a slow but substantial increase in chitin recovery stimulated by numerous potential applications of the polymer. The slow progress has been attributed almost entirely to lack of commercial interest by big business organisations, mainly because of the difficulties and uncertainties surrounding the supply and demand for the polymer [19]. Nevertheless, extraction and recovery on an industrial scale are presently being carried out in U.S.A. and Japan, and it is hoped that many countries who have abundant chitinous organisms and are involved in the marine food industry may become more involved in chitin production, if only as a secondary by-product.

Chitin and some of its derivatives are available through chemical product dealers such as B.D.H., Sigma Chemical Co., Eastman Organic Chemicals and Polyscience Inc.

1.3 The chemical structure of chitin

Chitin is claimed to be a linear polymer of repeating N-acetyl-D-glucosamine (NAG) residues as shown in Fig. 1.1. As such,

chitin is an amino sugar, a derivative of sugars in which a primary or secondary alcoholic hydroxyl group has been replaced by a primary amino group, acetylated in the case of chitin. Chitin is chemically similar to cellulose except that the hydroxyl group on the C2 position has been replaced by the amino acetyl group (acetamido) -NHCOCH_3 .

The repeating unit (NAG) contains two hexose residues generally referred to as chitobiose [20] shown in Fig. 1.1 with the numbering of the carbon atoms. Thus, the proper name is poly-N-acetyl-2-amino-2-deoxy- β -D-glucopyranose in which the repeating hexose units are linked together by 1,4- β -glucosidic bonds.

While there is now a general agreement on the constitution of NAG and the stereochemical position of the acetyl-amino group, the establishment of this was not an easy task for the early workers on chitin. The problem was aggravated by the complexity and variation in composition from source to source. Consequently, chitins extracted from various sources may differ in chain length, crystallinity and degree of deacetylation of the acetyl-amino groups [16,21]. Nevertheless, the outstanding work of Ledderhose [7] on the hydrolysis of chitin with concentrated hydrochloric acid was the basis for most other work done on the elucidation of the structure of chitin. On such hydrolysis, pure chitin gives a quantitative yield of acetic acid and an amino sugar later confirmed as 2-amino-2-deoxy-D-glucose [22,23]. Based on such hydrolytic products, Ledderhose [7] suggested that chitin was a glucosidic compound formed by the condensation of aminoglucose and acetic acid. However, not all the workers shared this view. Some believed that chitin was a complex containing both glucose and aminoglucose residues [24], while others like Tiemann [25] showed by reaction with phenylhydrazine that

the amino sugar was based on either glucose (Fig. 1.4) or mannose (Fig. 1.5).

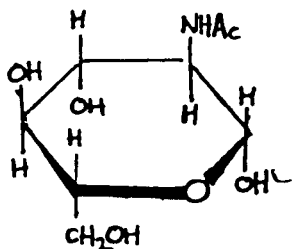

Fig. 1.4: Acetylglucosamine as a glucose derivative

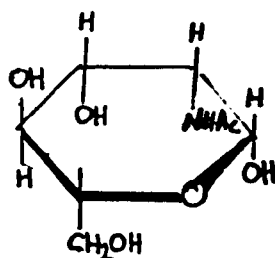

Fig. 1.5: Acetylglucosamine as a mannose derivative

It should be pointed out that Figs. 1.4 and 1.5 are only meant to illustrate the difference between glucose and mannose, because at the time Tiemann made his suggestion in 1886, the constitution of chitin and the attachment of the acetamido group at C2 were still in doubt. In fact, it was only in 1903 that Fisher and Leuchs [26] synthesised D-glucosamine and established its constitution as being that of a 2-amino hexose. They also confirmed the attachment of the acetamido group at C2, but left open the question of the stereochemical position (or the configuration) at C2. However, two groups, Haworth et al [21], and Cox and Jeffery [22] proved

chemically that the 2-amino hexose is related configurationally to D-glucose (2-amino-2-deoxy-D-glucose) and not to D-mannose, thus confirming Fig. 1.4 as the correct structure. This view has been confirmed through the isolation of N-acetyl-D-glucosamine from the products obtained from the mild hydrolysis of chitin by enzymes [27,28]. In more recent studies of the hydrolysis of chitin with concentrated mineral acids (eg. 10 N hydrochloric acid, 21 N sulphuric acid or 85% phosphoric acid), Hackman [29] showed also that chitin dissolves in these acids rapidly with degradation to form oligosaccharides (which are to some extent deacetylated) and N-acetyl-D-glucosamine.

The structural analogy between chitin and cellulose has also made structural identification of chitin much easier, since much of the work was done on a similar pattern to cellulose. Thus, Barker et al [30] showed that chitobiose octaacetate can be formed through the acetylation of chitin in a mixture of acetic anhydride and sulphuric acid (as a catalyst) at room temperature for 40 h and at 55°C for 11 h. Through the reactions of chitobiose octaacetate, it was shown that chitobiose (the repeating unit in chitin) was linked by a (1-4)glucosidic bond [13]. The (1-4)glucosidic linkage was also indicated by infrared absorption at 884-890 cm^{-1} [30].

Although it has been confirmed that chitin is composed of repeating N-acetyl-D-glucosamine residues there is evidence (based on elemental analysis [31]) and direct chemical analysis [32] to suggest that all the hexosamine may not in fact be N-acetylated. It has been suggested that one in every six or seven residues in the chain has a free-amino group [31]; the importance of this in binding to protein is discussed later.

1.4 The crystal structure of chitin

As indicated earlier, chitin has been confirmed through chemical evidence to be a polysaccharide composed essentially of N-acetyl D-glucosamine residues linked by a β -D-(1-4)glucosidic bond. However, the very complex nature of this polymer makes uncertain a lot of information about it; hence information from other techniques used for polymer structural determinations is necessary. Two such techniques used extensively to obtain deeper and clearer insight into the structural arrangement and bonding characteristics of chitin are X-ray diffraction and infrared spectroscopy. Through such techniques, it has been found that chitin occurs in three polymorphic forms, viz. α -chitin, β -chitin and γ -chitin. However, it is quite uncommon to find all the three forms in one organism, although it is claimed that the three exist in different parts of squid Loligo (α -, beak; β -, pen; γ -, stomach lining) [33]. According to Rudall [12], the three forms of chitin are associated to its multiple functions in organisms. In plants, it serves as an alternative to cellulose, in animals, as an alternative to collagen. While α -chitin is usually found where extreme hardness is required, β - and γ -chitins provide toughness, flexibility and mobility, and may have physiological functions other than supports such as control of electrolytes and transport of a polyanionic nature.

The three forms differ in the chain arrangement within the crystal cell and Figs. 1.6-1.8 show these differences as illustrated by Rudall [33]. In each case, the arrows indicate the direction of the chains in successive sheets.

α -chitin: This is the most abundant form and is found in arthropods and certain fungal cell walls. α -chitin is believed to be the most

compact and crystalline form where the chains are arranged in an antiparallel fashion, ie. alternately 'up' and 'down' (Fig. 1.6). When the structure of cellulose and chitin are compared, it is found that the antiparallel chain structure of α -chitin is analogous to cellulose II.

β -chitin: This is the form where the chains are parallel ie. pointing in the same direction (Fig. 1.7). It is the least crystalline (although β -chitin from diatoms are claimed to be highly crystalline [34]) and swells greatly in water. The parallel chain structure of β -chitin is analogous to cellulose I.

(A comparison of α - and β -chitins is given in Table 1.2)

γ -chitin: This is proposed to have antiparallel and parallel chains, and properties intermediate between α - and β -chitins. As shown in Fig. 1.8, γ -chitin has two chains 'up' to every one 'down'.

Rudall [33] has suggested that chain folding exists in the structure of chitin as in β - protein structures. The first indication of this was shown using β -chitin where it was suggested that on treatment with 6 N HCl, the parallel chains in the less stable β -chitin contracted to about half their original length and were transformed to α -chitin. Also γ -chitin can be transformed into α -chitin by treating it in saturated lithium thiocyanate solutions at room temperature [35]. As can be seen in Fig. 1.9, such a transformation was explained by each chain folding upon itself, ie. 50% contraction and change from β - or γ - to α - structure. The change occurred only in the swollen solid state and did not involve a stage where the chitin was in solution [33]. However, if β -chitin was dissolved, the chains on precipitation would recrystallize into the more stable α - form.

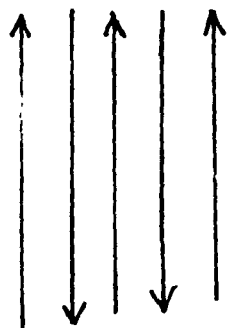

FIG. 1.6: Arrangement of chains in α -chitin (chains viewed in the plane of the sugar rings)

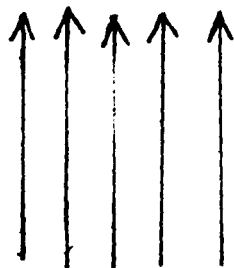

FIG. 1.7: Arrangement of chains in β -chitin (chains viewed in the plane of the sugar rings)

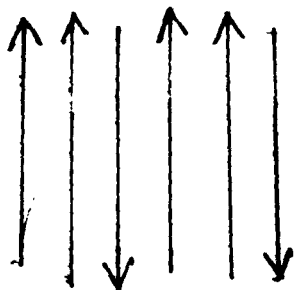
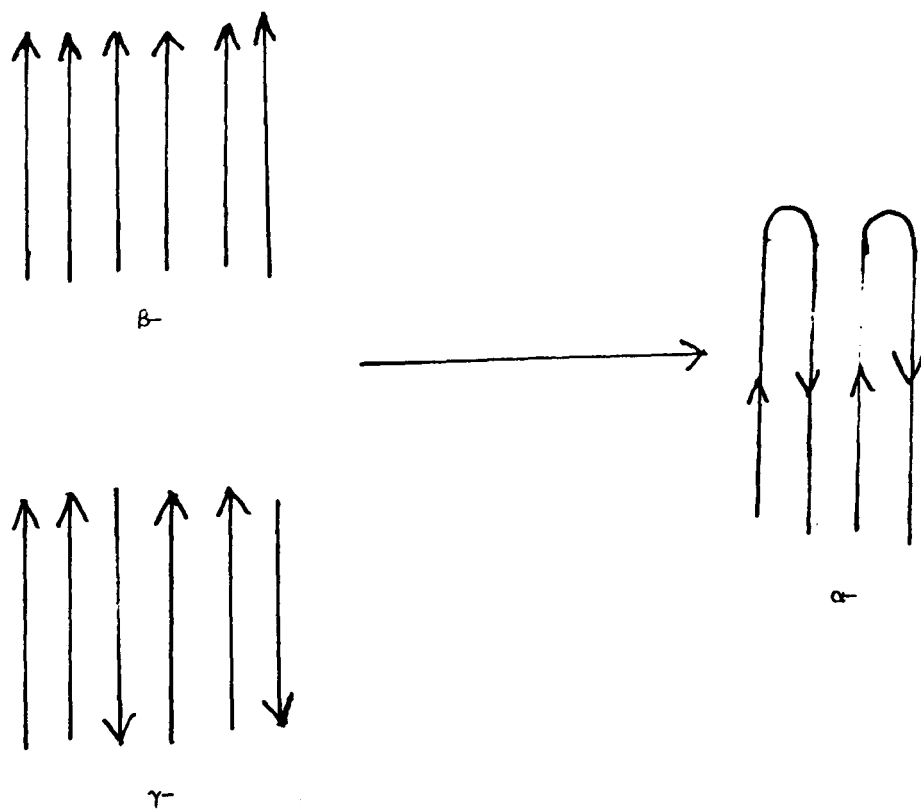

FIG. 1.8: Arrangement of chains in γ -chitin (chains viewed in the plane of the sugar rings)

TABLE 1.2: Comparison of α - and β -chitin [34]

<u>α-chitin</u>	<u>β-chitin</u>
1. Swells little in water	Swells in water
2. No change with humidity in the spacing (X-ray diffraction pattern)	Spacing changes with humidity (X-ray diffraction pattern)
3. α -chitin cannot be converted to β -chitin	β -chitin can be converted to α -chitin (treatment with strong acid)
4. Gives moderately sharp I.R. bands	It does give very sharp I.R. bands (Pogonophore and diatom spines)(not sharp in Loligo β -chitin)
5. 1656 cm^{-1} is present (not removed by D_2O)	No 1656 cm^{-1} band is present in Pogonophore and diatom spine β -chitin. In Loligo the 1656 cm^{-1} band is present but is easily removed by D_2O
6. Moderately crystalline	Loligo β -chitin less crystalline, Pogonophore and diatom spines highly crystalline
7. Has an antiparallel chain arrangement	Has parallel chain arrangement

FIG. 1.9: Formation of α - from either β - or γ - when each chain is folded



Although the concept that chitin in the solid state may have either parallel or antiparallel or folded chain arrangements has been overwhelmingly accepted, the detailed consideration of the results of X-ray and infrared spectroscopy analyses to determine the structure have resulted in a series of arguments over the years. Since Gonell [36] first reported the unit cell dimensions in chitin in 1924, several proposals, each time more refined than the previous, have been put forward. (see Table 1.3) Consequently, there are still uncertainties regarding not just the true crystal cell dimensions but also bondings in the structure. However, the work of some of the pioneers, mostly on α -chitin, is worth mentioning. Based on the structure of cellulose Meyer and Pankow [38] proposed an orthorhombic unit cell with the fibre axis repeat (10.46 Å) almost identical with that of cellulose (10.3 Å) [38]. With this model, there are four chains and eight pyranose rings contained in the cell (Fig. 1.10). The model was verified and accepted by other workers [39-41] though in some cases with slight adjustments in the values for a and b.

By the use of polarized infrared radiation, Darmon and Rudall [41] observed the general directions of intramolecular bonds in chitin. They correlated their findings with X-ray data and proposed a structure similar to that of Meyer and Pankow. They proposed the existence of hydrogen bonding between CO.NH groups of adjacent amino-acetyl side chains to form linked piles of chitin chains within the crystalline regions. It was further indicated that only some of the amino acetyl groups were involved in this type of linkage, the rest were perhaps of the type C=O---H-O. This suggestion was made due to the double absorption they obtained at 1656 cm^{-1} and 1625 cm^{-1} . The 1656 cm^{-1} band was assigned to

TABLE 1.3: Summary of the proposed unit cell dimensions and number of NAG residues of α -chitin (based on Blackwell [37])

Authors	Unit cell dimensions(\AA)			NAG residues	Reference
	a	b	c		
Gonell (1926)	11.58	10.44	19.42	10	36
Meyer and Pankow(1935)	9.40	10.46	19.25	8	38
Clark and Smith(1935)	9.25	10.46	19.25	8	39
Lotmar and Picken(1950)	9.40	10.27	19.25		40
Carlström(1957)	4.76	10.28	18.85	4	42
Dweltz(1960)	4.69	19.13	10.43*	4	43
Blackwell et al(1978)	4.74	18.86	10.32*	4	44

* Fibre axis

FIG. 1.10: Unit crystal cell of α -chitin proposed by Meyer and Pankow

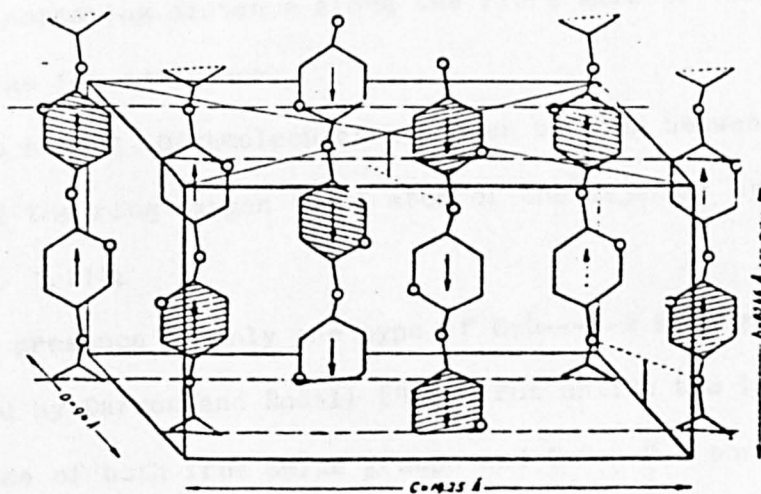

C=O---H-N bonds and the 1625 cm^{-1} to C=O---H-O bonds. In conclusion, chitin was considered to consist of structural units similar to those in cellulose, but possessing strong lateral C=O---H-N hydrogen bonds.

It was not until 1957 that a structure almost acceptable to most workers was proposed by Carlström [42]. The main features of the structure includes, viz.

- (i) an orthorhombic unit cell as proposed by Meyer and Pankow [38], but containing four pyranose rings instead of eight;
- (ii) the arrangement of the pyranose rings in 'bent' conformation similar to that proposed for cellulose by Hermans et al [45];
- (iii) a repeating distance along the fibre axis of 10.28 \AA essentially the same as for cellulose;
- (iv) the strong intramolecular hydrogen bonding between a C3 hydroxyl group and the ring oxygen (O5') atom of the adjacent pyranose ring (see Fig. 1.11);
- (v) the presence of only one type of C=O---H-N hydrogen bonds as earlier indicated by Darmon and Rudall [41]. But unlike the latter, he proposed an absence of both free amide groups and C=O---H-O bonds.

Carlström's work brought many reactions especially regarding the lack of bonding of the C6 hydroxyl group, and the lack of bonding between the sheets of chain along the fibre axis (b axis). There was also no explanation of the double absorption in the infrared spectrum at 1625 cm^{-1} and 1656 cm^{-1} earlier indicated by Darmon and Rudall [41]. This led to further suggestions, firstly by Pearson et al [46], based on the infrared absorptions they obtained at 3447 cm^{-1} and 3480 cm^{-1} . This was explained as due to intramolecular hydrogen bonding of the C6 hydroxyl group to both the bridge oxygen and the nitrogen atom in the adjacent

FIG. 1.11: b c and a c projections of the unit cell of α -chitin proposed by Carlstrom.

Hydrogen bonds are represented by dotted lines.

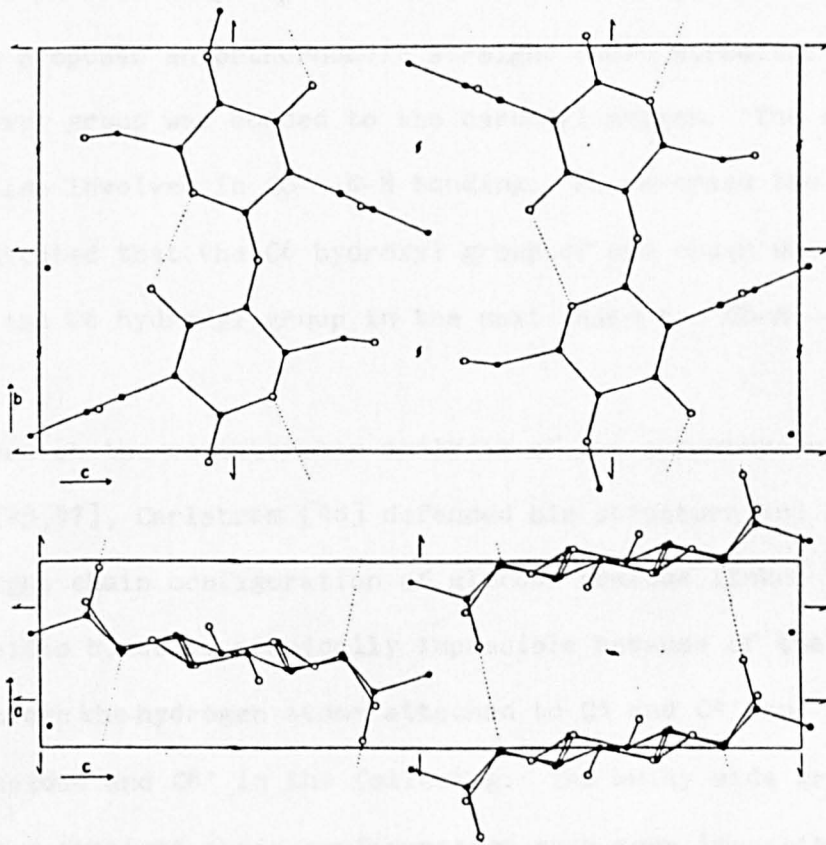

glucosamine unit (Fig. 1.12). Secondly, Dweltz [43] not only proposed almost entirely different hydrogen bonding, but also doubted the 'bent' conformation proposal made by Carlström [42]. He argued that for formation of such a structure, the bond between the C3 hydroxyl group and the ring oxygen must be very strong in order to force the chains to 'buckle', but then, the ring oxygen was already saturated and was therefore not sufficiently negative to enter into strong hydrogen bonding. He therefore proposed an orthorhombic straight chain structure in which the C3 hydroxyl group was bonded to the carbonyl oxygen. The carbonyl oxygen was also involved in CO---N-H bonding. He reversed the b and c axes and indicated that the C6 hydroxyl group of one chain was hydrogen bonded with the C6 hydroxyl group in the next chain ie. O6-H---O6" (Fig. 1.13).

Based on the considerable analysis of the structure of crystalline cellobiose [45,47], Carlström [48] defended his structure and argued that a straight chain configuration of glucose residue linked by 1,4- β -glucosidic bonds is sterically impossible because of the short distance between the hydrogen atoms attached to C1 and C4' and between O2 in one residue and C6' in the following. The bulky side group in chitin makes a straight chain configuration even more impossible. Although many workers [44,49,50] were still not satisfied with the assignment of hydrogen bonding in Carlström's structure, they preferred his 'buckled' chain configuration to the straight chain. The problem with Carlström's structure, apart from the objections earlier mentioned, was that it failed to account for the different properties of α - and β -chitins. Thus, further modifications were proposed by Haleen and Parker [49] and Blackwell et al [44]. In each case, the original hydrogen bonds proposed

FIG. 1.12: Proposed intramolecular hydrogen bonding of the C6 hydroxyl group to both the bridge oxygen and nitrogen by Pearson et al

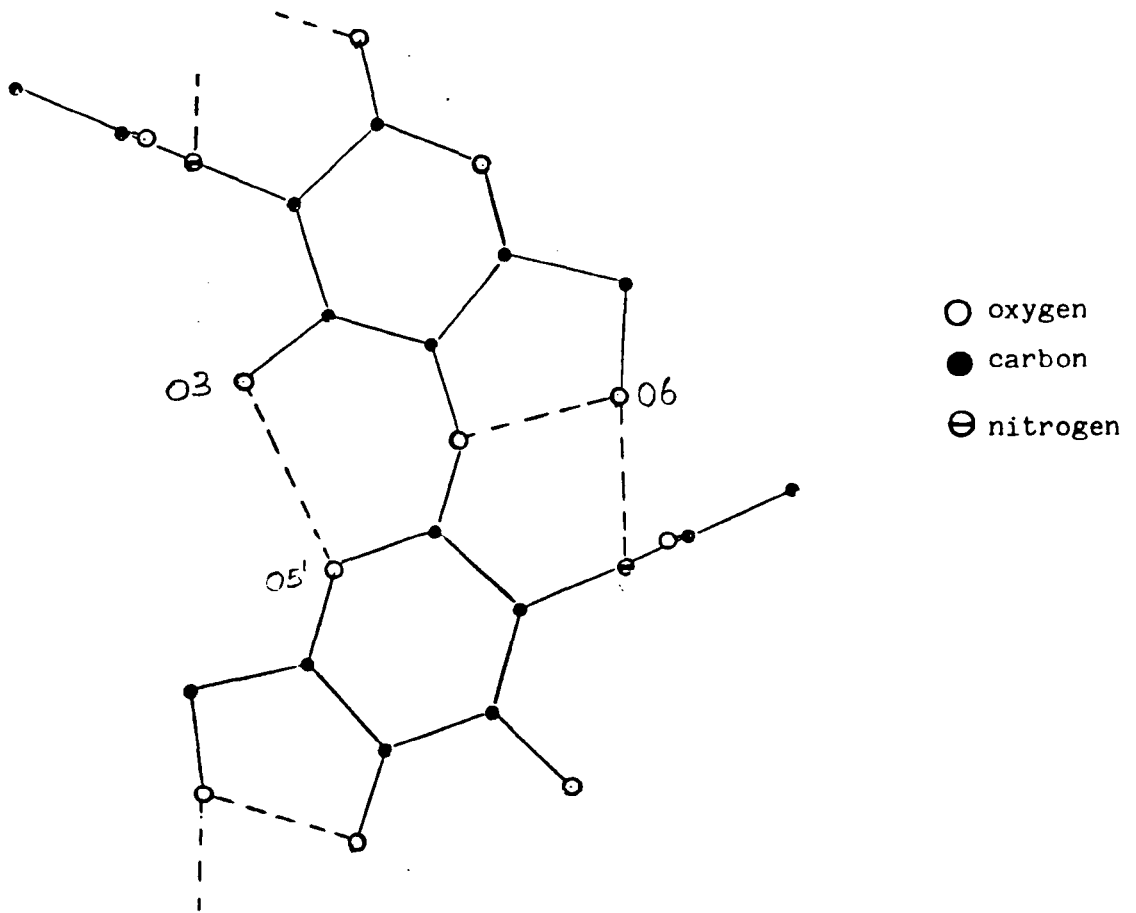
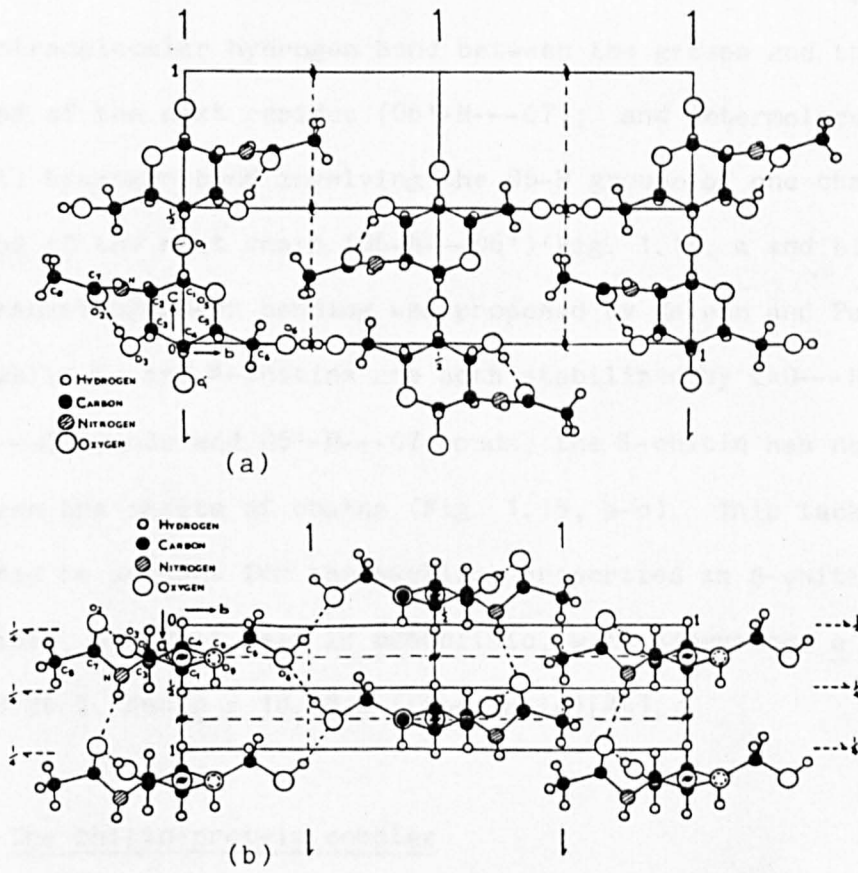

FIG. 1.13: The α -chitin structure proposed by Dweltz



a) a-projection

b) c-projection (fibre axis)

by Carlström were accepted (ie. $03-H---05'$, and $C=O---H-N$ hydrogen bonds). However, the $-CH_2OH$ groups were not hydrogen bonded and in order to involve them, Blackwell et al [44] assigned the groups different conformations on the two adjacent chains. They then proposed an intramolecular hydrogen bond between the groups and the carbonyl groups of the next residue ($06'-H---07$); and intermolecular (intersheet) hydrogen bond involving the $06-H$ groups of one chain to $06'-H$ groups of the next chain ($06-H---06'$)(Fig. 1.14, a and b). Similar intersheet hydrogen bonding was proposed by Haleen and Parker [49]. So, while α - and β -chitins are both stabilized by $C=O---H-N$ bonds, $03'H---05$ bonds and $06'-H---07$ bonds, the β -chitin has no bonding between the sheets of chains (Fig. 1.15, a-c). This lack of bonding is claimed to account for the swelling properties in β -chitin [44]. For β -chitin, the unit cell is monoclinic, with dimensions $\underline{a} = 4.85 \text{ \AA}$, $\underline{b} = 9.26 \text{ \AA}$, and $\underline{c} = 10.38 \text{ \AA}$ (fibre axis)[44].

1.5 The chitin-protein complex

Chitin, especially in animals, does not exist alone in nature, (see Table 1.1). It is most frequently found associated with protein, insoluble salts of calcium, lipids and other organic substances, although it has been claimed, as earlier indicated, that certain diatoms have spines which are pure β -chitin [18]. Because of the high proportion of protein (which varies according to the source of chitin), the system is usually referred to as the chitin-protein complex. The evidence for the existence of the complex has been reported by several workers [33,35,51, 52]. Most of such evidence is based either on the differences observed between the X-ray diffraction patterns of 'native' chitins and purified

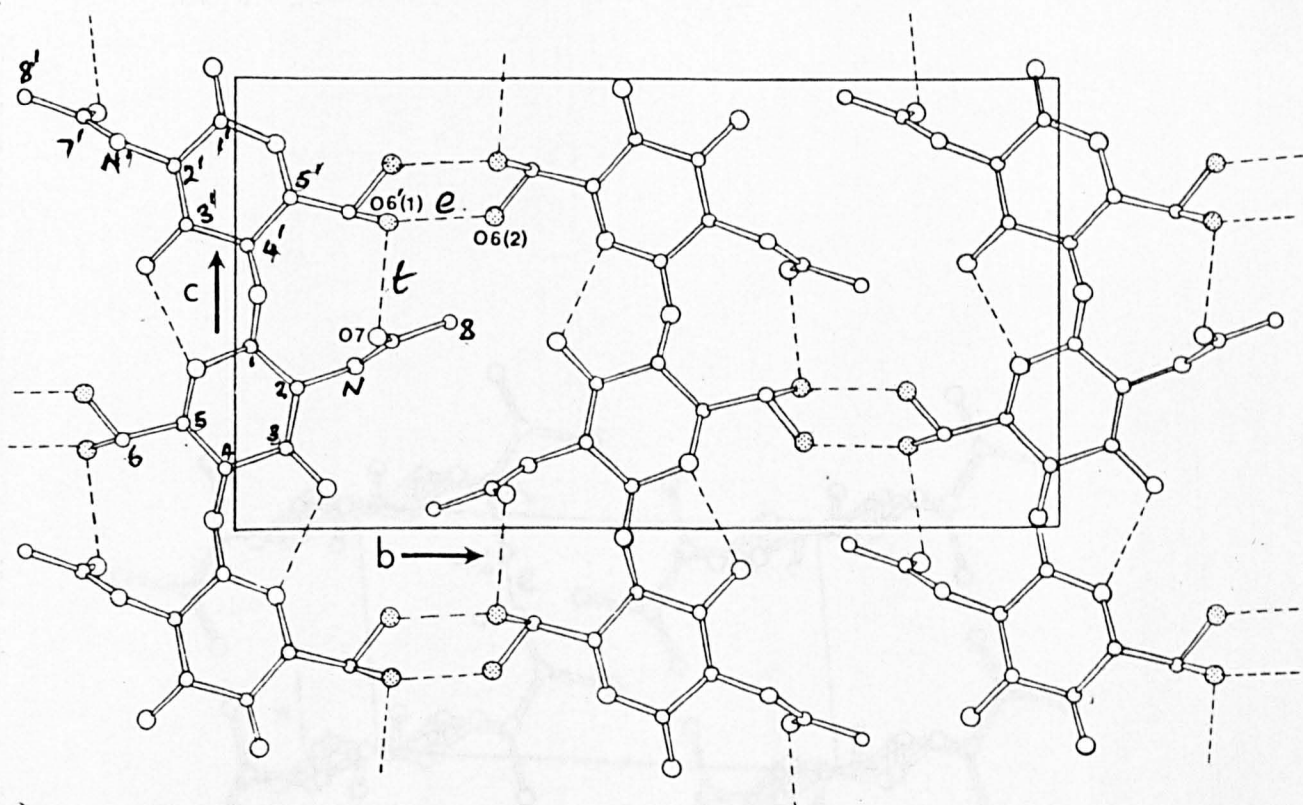
FIG. 1.14: The structure of α -chitin [44]

a) bc projection

e = intermolecular hydrogen bond
 t = intramolecular hydrogen bond

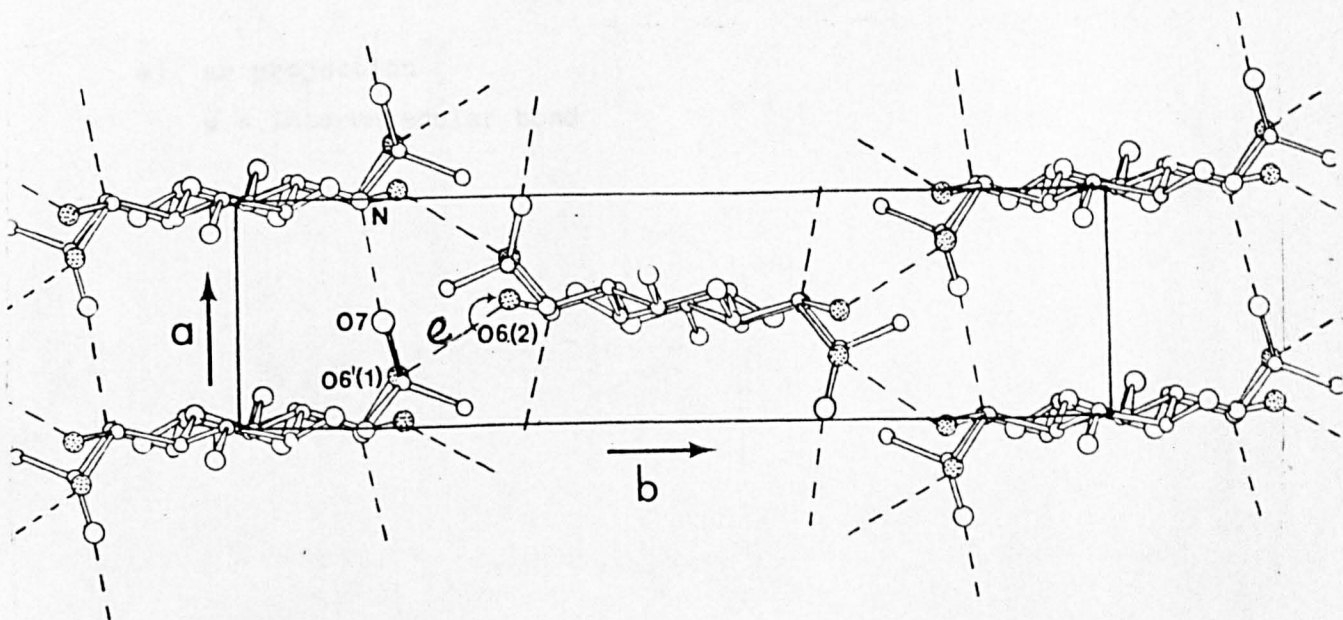

b) ab projection

FIG. 1.15: The structure of anhydrous β -chitin [44]

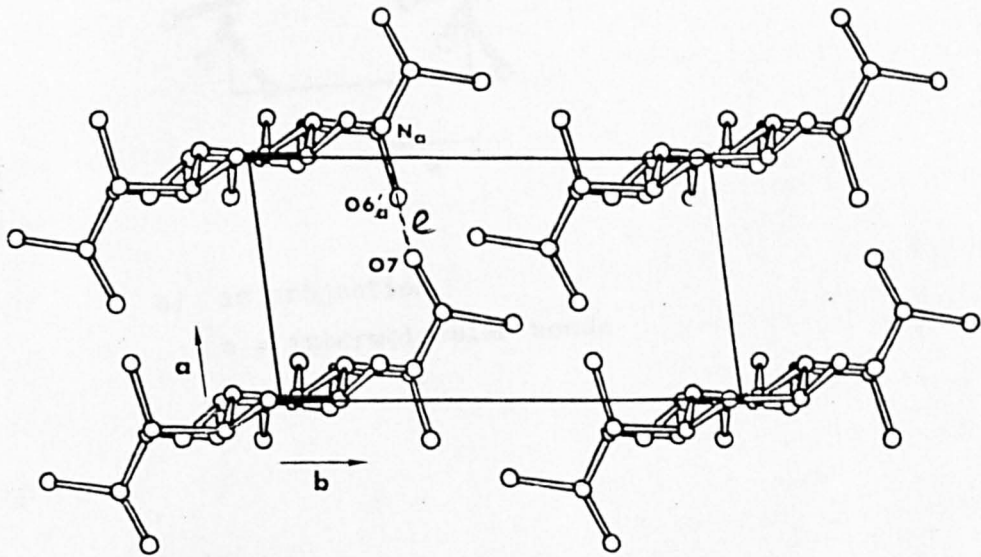

a) ab projection
e = intermolecular bond

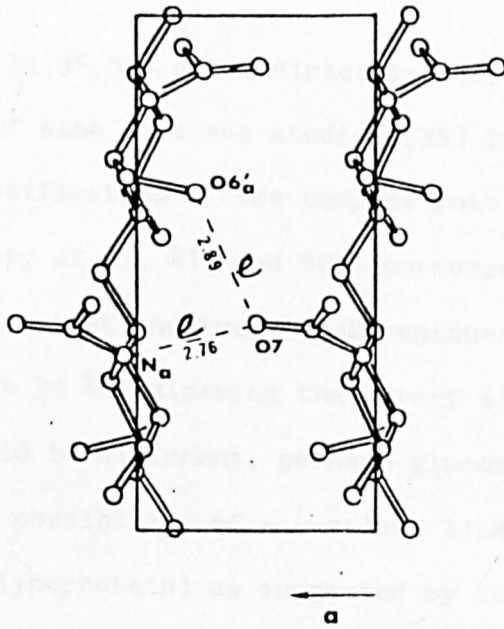

b) ac projection

e = intermolecular bonds

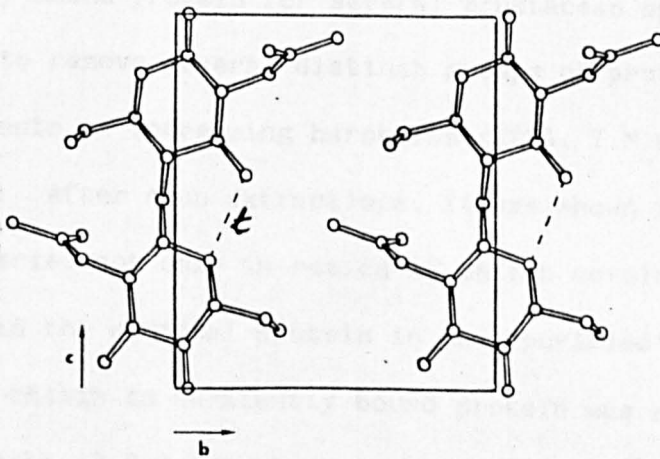

c) ac projection

t = intramolecular bonds

chitins [33,35,52] or on direct isolation of the proteins [51]. The results of some of these studies [35] led to:

- (i) classification of the complex into three groups having axial periodicity of 31, 41, and 62 Å corresponding to protein repeats at every six, eight and twelve NAG residues. The major period observed is that at 31 Å indicating that every sixth residue along the chitin chain could be different, perhaps glucosamine instead of NAG.
- (ii) the possibility of a covalent link between chitin and protein chains (glycoprotein) as suggested by the presence of amino acids (aspartic acid and histidine) even after all protein links have been broken [51]. This, perhaps, explains why it is extremely difficult to remove all traces of protein from chitin during isolation. (It should be noted that not all workers accept that the binding is via aspartic acid and histidine [53]).

Recently Austin et al [54] determined the ratio of chitin to covalently bound protein for several crustacean species. To do this, they had to remove several distinct groups of proteins using in each case solvents of increasing harshness (EDTA, 7 M urea, 0.1 N NaOH and 1 N NaOH). After such extractions, it was shown that the crustacean species varied not only in ratios of chitin covalently bound to protein but also in the residual protein in the 'purified' chitins. Thus, the ratios of chitin to covalently bound protein was reported to be 9:1 for red crab; 3.2:1 for stone crab; 2.8:1 for blue crab; 1.7:1 for brine shrimp and 0.9:1 for horseshoe crab. The residual protein remaining in chitin after the most drastic treatment (1 N NaOH at 100°C for 48 h) was between 0.1 and 0.5%.

1.6 Recovery of chitin [55,16]

The commercial production of chitins is mainly based on crustacean species because of their apparent abundance, and chitins from these sources are found heavily associated with proteins, calcium carbonate and pigments. Consequently, their extraction has often involved methods aimed at demineralization, deproteinization and decolorization. These have been accomplished by successive treatments in mineral acid and alkali in either order. In addition, a follow up treatment in ethanol or bleaching with potassium permanganate, sodium metabisulphite or hydrogen peroxide may be necessary to remove pigments. As would be expected, a variety of procedures have been employed, some of which were drastic enough to result in removal of some of the acetyl groups and even sometimes to cause break down of the chains. Hence decalcification with EDTA followed by digestion with a proteolytic enzyme such as papain or a bacterial proteinase have been used, although up to 5% protein may still be left in chitin after the extraction [55]. In any case, it is doubtful if a pure, fully acetylated chitin can ever be obtained after extraction considering the point made earlier (see 1.3) that chitin in nature contains glucosamine units.

The extraction methods usually encountered in the literature have been extensively reviewed by Muzzarelli [55]. Generally, the shells are first cleaned of all adhering flesh under running water, dried in an oven at 50-100°C and then crushed into small pieces; or first ground, then the bits of flesh and other soft tissue are separated from the shell. Either step is necessary before any chemical processing. The flesh and soft tissue can be recovered as by-products for feeding fish,

chickens and other animals. After this initial step, the amount of acid and alkali required are then determined based on the mineral and protein content to be removed. A typical procedure describing the extraction of chitin from crab shells is as follows [56]:

the crabs were first cooked in boiling water, and after the meat had been properly removed the residue was soaked in NaOH (1 N) for 7 days. This was followed by washing in water, drying in an oven ($\sim 100^{\circ}\text{C}$) and grinding to about 20 mesh. The powdered shells (800 g, 7.04 moles assuming 88% CaCO_3) and water (2 l) were then charged into a flask (5 l) fitted with an overhead stirrer and dropping funnel. Hydrochloric acid (1.20 l; density 1.18 g/cm^3 , 14.4 moles, 1.02 equivalent) was slowly added with stirring over 8 h and then the stirring was continued for a further 16 h. After this time, the pH of the liquid was 1-2. The products were filtered, washed until the washings were at pH 3-4. This was followed by treating in NaOH (1.5 l, 1 N) for 24 h at 80°C with stirring. The alkali treatment was repeated three times. Finally, the products were filtered, washed until neutral and dried in a vacuum oven at 100°C . The solid was ground to 20 mesh and further dried under vacuum in the presence of P_2O_5 . (Yield 85-95 g, 10.6-11.9%).

1.7 Reduction of molecular weight of chitin

Chitins extracted directly from crustacean shells as described above are generally considered to be of high molecular weight ($0.4-3.5 \times 10^6$) [57,80,79], if the extraction methods employed are not so severe as to result in excessive hydrolytic depolymerisation and deacetylation. Consequently, it is often difficult and sometimes impossible to completely dissolve these chitins in solvents such as

amide-LiCl, although the degree of solubility will also depend on the source of the chitin [57]. Thus, the percentage solubility obtained by Austin and Rutherford [57] for brown shrimp was 92%, blue crab 58%, and Dungeness crab 30%. It was indicated that in spite of these differences, the molecular weights obtained were so high that it might be necessary to depolymerize the chitins in mild conditions in order to produce films and fibres.

Several methods mostly based on acid treatments have been suggested for reducing the molecular weight of chitin. The first indication of such treatments was by Karrer and Hoffman [58], who used concentrated HCl to dissolve chitin and, after precipitation, obtained what they claimed was purified and lower molecular weight chitin. Such treatment in concentrated mineral acid will no doubt cause excessive degradation [29,39], quite apart from the fact that not all chitins are soluble in concentrated HCl (see section 4.1). A milder method suggested by Austin [59] was to dissolve say 1 part of chitin in 6 parts of 1,2 chloroalcohols (eg. 2-chloroethanol) containing 8 parts of a mineral acid (eg. 73% H_2SO_4) for 8 h. After filtering off the undissolved particles, the solution was neutralized with excess aqueous ammonia and the chitin precipitated by addition of water or methanol, or acetone. After filtering and washing successively in methanol and acetone, the product was dried to give a powdery material. A similar method was used to prepare what was described as hydrated chitin; this water-swelled chitin when treated with excess alcohols, aldehydes or ketones was claimed to form complexes (eg. chitin methanolate or acetate or methyl ethyl ketonate) which were suitable for the preparation of films and fibres.

Recently, a more effective way of reducing the molecular weight of chitin was reported by Dunn and Farr [60], Austin and Brine [61], and Austin et al [54] using partial hydrolysis and high-speed shearing to produce the so called microcrystalline chitin (MCC). The procedure involved treating chitin with phosphoric acid in 2-propanol at above 80°C for 2 h, quenching with water at room temperature for 15 min, centrifuging at 2000 rpm and washing in both water and acetone. After each wash, the material was centrifuged and the supernatant liquid removed. The product was filtered, sheared in water at 20,500 rpm in a blender, filtered again and finally freeze-dried [54]. The material obtained was described as friable and easily dispersible. Although the procedure is claimed to reduce the molecular weight of chitin to between 5,600 and 75,000 the solubility of the MCC was limited in DMA-LiCl because it contained about 0.4-0.8% phosphorus, present as phosphoric acid [62]. This was said to be held in the form of a phosphate salt by the free amine groups in the microcrystalline chitin. More recently Deschamps and Castle [63] modified the procedure and obtained a phosphate free MCC. The modification involved washing the product obtained before the shearing stage with 1% NaOH until a neutral or alkaline pH was reached. After washing twice with tap water and once with deionized water, the material was sheared in a blender containing deionized water, and then freeze-dried. It is claimed that the modified procedure produces MCC which has a better solubility in DMA-LiCl.

A similar procedure using p-toluene sulphonic acid in 2-propanol has been described by Searles [56] and was used in the present study.

1.8 Chitin derivatives

In spite of the unique properties and the diversity of uses proposed for chitin [64-66] the technology to convert chitin into a commercially useful polymer has not been really developed. Early interests in chitin were mostly due to its structural similarities to cellulose, as such similarities meant that chitin should have parallel potential uses. However, the amino acetyl groups and the regular compact structure of chitin make it both difficult to dissolve and also to swell [67], leading to very slow chemical modifications. Therefore, when attempts to find suitable solvents for chitin failed, many turned to techniques which chemically modified chitin and hence promoted solubility in a wide spectrum of solvents. Although some of the chemically modified chitins are claimed to be highly desirable in order to promote the usefulness of chitin and widen the scope of its industrial and other practical uses [67], they are not without limitations as drastic reaction conditions are often necessary to obtain most of them. Some of these derivatives are tabulated in Table 1.4, the most important of which is chitosan, poly(1,4)-2-amino-2-deoxy- β -D-glucopyranose.

Chitosan is the deacetylated form of chitin and has been found to exist in nature in the cell walls of some fungi [68]. However, chitosan is mostly obtained by treating chitin with 30-50% alkali (mostly NaOH) at 100-180°C for 0.5-16 h. When fully deacetylated (rarely achieved), chitosan has two amino groups and four free hydroxyl groups in its repeating unit (see Fig. 1.2). The major factors which affect the deacetylation process include alkali concentration, time of treatment, previous treatment and particle size. Detailed studies of the

TABLE 1.4: Derivatives of chitin

Type	Solvent	Reference
Acetylchitin eg. diacetylchitin	Formic acid Dichloroacetic acid (DCA) Methanesulphonic acid	75
Ethylchitin	Benzene, xylene, toluene, methyl ethyl ketone, chloroform and alcohols if D.S.>1	16
Hexanonylchitin	Benzene, dioxane, ethyl acetate, butanol, m-cresol, tetrahydrofuran, methylene chloride, acetic acid and DCA	76
Decanoyl- and dodecanoylchitins	Benzene, M-cresol, methylene chloride, tetrahydrofuran and DCA	76
Benzoylchitin	Benzyl alcohol, DMSO, formic acid, DCA; fairly soluble in: hexamethyl phosphoramidate, DMF, DMA, mixtures of tetrachloroethane or dichloroethane and alcohols such as ethanol and butanol	77
Benzylchitin	As for acetylchitin	77
Formyl-, propionyl- and butyrylchitins	As for acetyl chitin	78
Highly butyrylated chitin	Dioxane, tetrahydrofuran, acetone, DMF, acetonitrile, acetic acid and methanol	78

deacetylation process have been carried out [69-73].

Chitosan dissolves in dilute aqueous organic acids (0.25-10% at pHs below 6) such as formic, acetic, propionic, oxalic, malonic, succinic, adipic, lactic, pyruvic, malic, tartaric and citric. It is also soluble in dilute (1% or less) nitric and hydrochloric acids, 3:1 glycerol:water with 1% acetic acid, 50% methanol or ethanol: 5% acetic acid (% by volume), 40% isopropanol or acetone:3% acetic acid and 80% glycerol:3% acetic acid. Formic acid (0.2-98%) is claimed to be the best solvent [74].

Some, but not all of the chitin derivatives described have been used in fibre production (see section 1.10).

1.9 Preparation of fibres and films from chitin

In order to produce fibres from chitin or its derivatives it is essential to prepare a spinning solution by dissolving chitin or its derivatives in a suitable solvent and to extrude such solutions by wet or dry spinning methods to form fibre. For more than half a century efforts have been made to prepare such fibres but with limited success, despite the chemical similarity of chitin with cellulose. The lack of success can be almost wholly associated with the problem of finding a suitable solvent for chitin. Chitin, like cellulose, is a very difficult polymer to dissolve due mostly to the high degree of crystallinity and the strong inter- and intra-hydrogen bonds. The extent of solubility in a given solvent also appears to be influenced by the source, differences in conformation, method of isolation, and the amount of residual protein left in the polymer as impurities. Thus, chitin obtained from crab shells (α -conformation) is more difficult to dissolve than chitin from

Loligo pen (β -conformation) [79]. Where a severe isolation procedure is employed resulting in a high degree of depolymerisation and deacetylation, solubility will be greatly improved [80]. Even chitins from similar sources such as red, blue and Dungeness crabs isolated under similar conditions, differ in solubility [57]. The cause of this difference is not really known, but may be connected with the acetyl content [57].

The first recorded attempt to spin fibres from chitin was in 1926 when Kunike [81] spun from a 6-10% chitin solution in cold concentrated sulphuric acid. The fibres were spun into water, or dilute acids, or alkalis or alcohols, and the coagulated filaments were washed and dried under tension to give an average tensile strength quoted as about 35 kg/mm^2 , (about 2.5 g/dtex assuming a density of 1.4 g/cm^3). Although the strength quoted is high, spinning of chitin from concentrated H_2SO_4 could not have been much of a success since it was not followed up presumably because concentrated mineral acids, whether hot or cold, degrade chitin through the hydrolysis of the glucosidic linkages [29,39].

A similar attempt was made (also in 1926) by Knecht and Hibbert [82] with chitin dissolved in cold concentrated hydrochloric acid but this solvent was said to be not suitable for fibre formation though films were obtained. In 1936 Clark and Smith [39] made a "syrupy colloidal solution" of chitin with aqueous lithium thiocyanate saturated at about 60°C and heated to 95°C ; they extruded the solution through a fine tip into a high concentration of acetone in water to precipitate the filaments. When stretched during formation, the filaments were reported to develop a considerable degree of orientation, but were readily swollen when soaked in water or salt solution; no fibre properties were given

By converting chitin into chitin xanthate, Thor [83] and Thor and Henderson [84,85] in 1939-1940 found that it could be regenerated if extruded into a suitable coagulating bath to form filaments, films, tubes, straws etc. One of the examples is quoted for the preparation of chitin xanthate [83]: 150 g of purified chitin was steeped in 3 litres of 40% NaOH at room temperature (25°C) or lower for 2 hours. Excess caustic soda was removed by pressing to give a press cake weighing approximately three times as much as the original chitin, in this case about 450 g. The pressed cake was shredded and then shaken in a closed vessel with 60 ml of carbon disulphide for 4 hours at 25°C, after which the mixture was transferred to a thermos jug and mixed with 1.6 kg of crushed ice. Mixing was continued for 1 hour, then the jug was closed and allowed to stand for 12-16 hours. After this period, the dispersion was mixed thoroughly, filtered and deaerated under vacuum.

Chitin xanthate dispersions were observed to have viscosities comparable to the viscosities of viscose. The viscosity was influenced considerably by the method used to purify the original chitin. Thus, chitin obtained from shrimp waste by treatment with cold acid and NaOH solutions gave a chitin xanthate dispersion which was gelatinous and heterogeneous except at concentrations "considerably below 7% chitin". However, by bleaching with a solution of potassium permanganate followed by treatment in oxalic acid, smoother dispersions with lower viscosities were obtained. When stored at room temperature, the chitin xanthate dispersion eventually sets to a firm gel, as does viscose, due to hydrolysis of the xanthate groups. It was also observed that deacetylation occurred during storage. However, when stored at 0°C, it was claimed

that no appreciable deacetylation occurred.

Although the process of making fibres was not described, Thor and Henderson [85] reported a process for producing regenerated chitin films. The process involved immersing a chitin xanthate dispersion (spread on a glass plate) into an aqueous bath containing 40% ammonium sulphate and 5% sulphuric acid. At the completion of regeneration, the films were washed successively in running water and in 1% ammonium hydroxide. Before drying, they were treated with a softening agent (eg. 15% glycerine) for about 30 minutes, blotted free of excess solution and dried after stretching on a frame to prevent shrinkage. The tensile properties of such films were reported to be about 9.49 kg/mm^2 (0.68 g/dtex) in the dry state and 1.75 kg/mm^2 ($\approx 0.13 \text{ g/dtex}$) in the wet state. When compared with regenerated cellulose films prepared from viscose under similar conditions, having a tensile strength of 9.10 kg/mm^2 (0.65 g/dtex) in the dry state and 4.77 kg/mm^2 (0.34 g/dtex) in the wet state, it was found that their dry strengths were almost the same, but the wet strength was lower for chitin.

A method for the production of chitin fibres based on the preparation of chitin xanthate by Thor [83], but modified slightly was described by Balassa and Prudden [86] in 1978. Fibres were prepared by spinning into a coagulating bath containing 8% sulphuric acid, 25% sodium sulphate and 3% zinc sulphate in water at 40°C . The weak filaments were collected in skeins and had tenacities between 0.6 and 1.0 g/d ($0.54\text{--}0.9 \text{ g/dtex}$). A number of nonwoven fabrics prepared from filaments 0.15 mm in diameter were directly used in wound-healing studies in humans and animals, and were reported to be effective in accelerating the healing process. It should be noted that before the above article

was reported, several other reports had been published especially by Balassa on the wound healing characteristics of chitin [87,88] and its derivatives [89]. However, details of fibre spinning were not reported. From such studies it was indicated that the source of chitin was important in the wound healing efficacy. Chitins from king crab lobster, Penicillium notatum and Phycomyces mucor were observed to be more suitable in this respect than those from shrimp or Dungeness crab. It was suggested that the reasons could be due to significant differences in the structure of the chitins [86].

Chitin fibres with slightly improved tensile properties were produced from chitin xanthate by Noguchi et al [90], also in 1978. The xanthate dope (5% chitin and 4.5% alkali) prepared had a viscosity which was reduced to 130 poise by ageing for 14-18 hours. However, the viscosity was still claimed to be too high for spinning and an equimolar amount of urea per N-acetylglucosamine residue was added to drop the viscosity to 100 poise. The solution was filtered, degassed at room temperature and spun into a coagulation bath containing 10% sulphuric acid, 25% sodium sulphate and 1% zinc sulphate, using stainless-steel spinnerets (50 holes, 0.1 mm or 30 holes, 0.22 mm). Ethanol was used at room temperature in the draw bath, and the fibres produced were washed with water and ethanol before drying on a roller at 110°C. Figure 1.16 shows the spinning apparatus used and Table 1.5(a) the tensile properties of the fibres produced. The fibres were said to have a high Young's modulus (not shown in the table) and dry tenacity, but poor wet and loop tenacities.

Chitin xanthate dispersions are miscible on any ratio with cellulose viscose and such blends can be spun into useful fibres. The

FIG. 1.16: Spinning apparatus for chitin-viscose fibres [90]

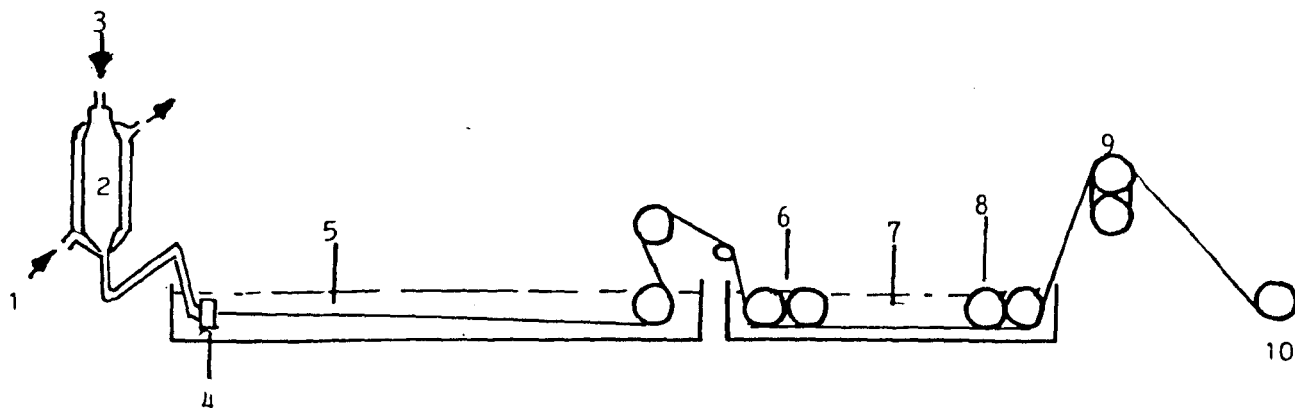

1. Cold water
2. Spinning solution
3. Pressure
4. Nozzle
5. Coagulation bath (10% sulphuric acid, 25% sodium sulphate and 1% zinc sulphate)
6. First roller
7. Elongation bath (ethanol)
8. Second roller
9. Hot roller (110°C)
10. Winder

TABLE 1.5(a): Properties of chitin fibres obtained
from chitin xanthate dope [90]

Denier		3.08	8.16	11.30	17.78
Tenacity (g/d)	Dry	1.17	1.52	1.30	0.90
	Wet	0.22	0.15	0.10	0.02
Elongation (%)	Dry	11.2	5.8	5.1	3.9
	Wet	10.9	4.7	6.4	2.2
Knot	Strength(g/d)	0.18	0.10	0.12	0.08
	Elongation(%)		9.3	6.0	7.7
Loop	Strength(g/d)		0.07	0.06	0.07
	Elongation(%)		4.2	4.6	5.2

dtex = denier x 1.111

g/dtex = (g/d)/1.111

TABLE 1.5(b): Properties of chitin and cellulose-chitin fibres [90]

Chitin content (%)		100	0	1.5	3	5	10
Denier		11.30	12.9	11.2	23.7	25.8	26.9
Tenacity (g/d)	Dry	1.30	2.09	2.08	1.75	1.37	1.20
	Wet	0.10	1.06	1.02	0.66	0.53	0.44
Elongation (%)	Dry	5.1	18.4	15.6	19.3	15.1	14.4
	Wet	6.4	28.4	24.2	26.1	23.3	19.2
Knot	Strength(g/d)	0.12	1.42	1.12	1.19	0.99	0.88
	Elongation(%)	6.0	17.3	10.5	19.5	14.1	15.1
Loop	Strength(g/d)	0.06	1.26	0.96	1.56	1.10	1.05
	Elongation(%)	4.6	3.1	2.8	6.7	5.4	4.4

properties of mixed cellulose-chitin fibres prepared by Noguchi et al [90] under the spinning conditions used for preparing chitin fibres are shown in Table 1.5(b). The fibres were reported to have better qualities than chitin fibres or viscose-rayon fibres. The fibres containing 3% chitin, were found to possess excellent qualities of loop tenacity, dyeability and ramie-like texture.

While attempts were being made to improve fibre production through the xanthate route, other efforts were directed towards discovering new solvents for chitin which would promote direct spinning, as it appeared that the xanthate route was not only tedious but produced fibres with limited properties. Thus, Austin [59] in 1975 reported new solvent systems consisting of chloroalcohols in conjunction with aqueous solutions of mineral acids or with certain organic acids. The chloroalcohols that may be used include:

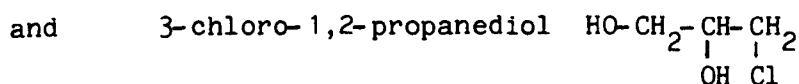
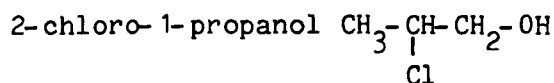
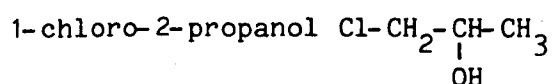
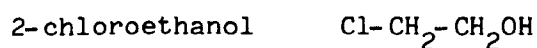

Although a mixture comprising 1-chloro-2-propanol and 2-chloro-1-propanol (called propylene chlorhydrins) may be used, the simple 2-chloroethanol was preferred. The solvent systems, generally, were reported to dissolve chitin rapidly at room or at mildly elevated temperature, to give relatively low viscosity chitin solutions. No attempt has been made so far to spin fibres from these solvent systems, although it is claimed

that the hydrolytic degradation of chitin in them was relatively slow.

Barely two months later, Austin [91] reported other new solvent systems consisting of acids such as di- or trichloroacetic alone or in combination with organic solvents such as formic acid, acetic acid, chloral hydrate, methylene chloride etc. With anhydrous systems involving 40% trichloroacetic acid/40% chloral hydrate/20% methylene chloride, Austin and Brine [92] in 1977 claimed to have obtained very high strength cold-drawn monofilaments and films shown in Table 1.6. Details of the spinning procedures were not given, but, it was reported that chitin solutions (prepared within a period of 30 minutes) were extruded into acetone to form a monofilament or cast into film on a glass which was then immersed in acetone. In each case the products were washed several times with fresh acetone, neutralized in a 5% NaOH-KOH mixture in 2-propanol, washed with water and finally air-dried. Films prepared were claimed to be capable of being cold-drawn to twice their original lengths. It was also noted that the chitin retained solvent tenaciously and that, even after neutralization and extraction with methylene chloride, the samples still contained portions of the original chitin solvents used as indicated by the chlorine contents (see Table 1.6). However, further treatment in a boiling solution of 1% NaOH in 2-propanol showed that the chlorine content had dropped from 5-10% to about 0.7%.

Although chitin is easily dissolved in these solvents even at low temperatures, Tokura et al [93] in 1979 reported that the spinnability of solutions of chitin in such solvents as trichloroacetic acid or methanesulphonic acid (the latter was also found to be a solvent for

TABLE 1.6: Properties of chitin monofilament film obtained from 2% chitin dissolved in 40% trichloroacetic acid, 40% chloral hydrate and 20% methylene chloride [92]

Material		Filament	Film
Tensile strength	(kg/mm ²)	63	104
	(g/dtex)*	4.30	7.10
Elongation	(%)	13	44**
N ₂	(%)	5.03	5.03
Cl ₂	(%)	5.03	9.45

* $\text{g/dtex} = (\text{kg/mm}^2) / (\rho \times 10)$ ($\rho = 1.465 \text{ g/cm}^3$)

** cold drawn

chitin) could not be observed, owing to the rapid reduction in viscosity within a short period even at low temperatures. However, they obtained fibres from 3-4.8% chitin-formic acid solutions containing a small amount of dichloroacetic acid and isopropyl ether (to reduce the viscosity to about 100 poise). The solutions were prepared through a repeated freezing process. Fibres were spun using a 90 μm , 50 hole spinneret into various coagulation baths. They were drawn by between 10 and 35% to give fibres with dry tenacities 0.68-1.59 g/d (0.61-1.43 g/dtex) and extensibilities 2.7-4.3%. Details of the spinning conditions used and the fibre properties obtained are shown in Tables 1.7(a) and 1.7(b). From the results, it was suggested that the fibre spun into ethyl acetate (1st coagulation bath) and water (2nd coagulation bath) with a dry tenacity of 1.33 g/d (1.2 g/dtex) and an extensibility 4.3% seemed to be the best. SEM micrographs of the fibre surfaces showed that only the fibre spun into isopropyl ether as the first coagulation bath showed a dull surface and many cracks along the fibre axis; otherwise, the fibres prepared under other conditions were claimed to have lustrous and smooth surfaces.

During the 70s, other solvent systems for chitin were also disclosed. Capozza [94] in 1976 reported the wet and dry-spinning of chitin dissolved in hexafluoroisopropyl alcohol and hexafluoroacetone sesquihydrate. Fibres obtained were said to be suitable as absorbable sutures, or other absorbable surgical elements. In a typical dry-spinning operation, the spinning dope was prepared by dissolving 3 parts by weight of purified chitin in 97 parts by weight of hexafluoroisopropyl alcohol. The mixture was heated to about 55°C with gentle stirring until the chitin dissolved. The solution was then pumped through a

TABLE 1.7(a): Spinning conditions used by Tokura et al [93]

Sample number		31	56	79	80	61	62
Spinning condition	Solvent	FA-DCA (92:8)		FA-DCA-iPE (83:11:5)		FA-DCA-iPE (92:5:3)	
	Concn/%,w/v	3.0	4.0	3.8	3.8	4.6	4.6
Spinning pressure		1.0-1.3(kg cm ⁻²)					
Nozzle		Pt,0.09 mm ϕ -50 holes					
Coagulation bath	1st	EtOAc	iPE	Ace	Ace-iPE	EtOAc	EtOAc-iPE
	2nd	EtOH	50% AcOH:EtOH(2:5)			cold water	
Stretching bath		Water(60 ^o C)					
1st roller/m min ⁻¹		5.6	5.2	6.5	6.5	6.2	6.2
2nd roller/m min ⁻¹		7.3	5.8	7.8	8.8	8.0	8.4
Elongation ratio		1.32	1.10	1.20	1.35	1.29	1.35

TABLE 1.7(b): Fibre properties quoted by Tokura et al [93]

Sample number	31	56	79	80	61	62	
Tenacity/g d ⁻¹	Dry(20°C,65%RH)	1.32	0.68	1.26	1.59	1.33	1.02
	Wet(20°C,100%RH)	0.18	0.23	0.16	0.23	0.27	0.14
	Wet(90°C,100%RH)	0.18	0.23	0.27	0.37	0.50	0.40
Elongation/%	Dry(20°C,65%RH)	2.7	2.9	3.4	2.7	4.3	2.8
	Wet(20°C,100%RH)	7.8	10.8	4.6	3.6	8.6	4.6
	Wet(90°C,100%RH)	7.1	13.0	6.8	7.5	10.1	8.8
Knot strength/g d ⁻¹	0.45	0.45	0.12	0.08	0.24	0.11	
Density/g cm ⁻³	1.382	1.347	1.395	1.397	1.385	1.384	
Moisture recovery/%	12.9	13.0	12.9	14.0	14.0	14.7	
Denier/d	25.5	3.2	2.0	3.0	2.1	2.0	

Solvent compositions are expressed as a volume ratio.

FA, formic acid; DCA, dichloroacetic acid; IPE, isopropyl ether;
EtOAc, ethyl acetate; Ace, acetone; AcOH, acetic acid;
cold water, 12-14°C.

spinneret (16 holes, 100 μm in diameter) and the spun fibres passed through a nitrogen atmosphere. The fibres formed were wound on a bobbin and stored hot under vacuum for several days, after which they were stretched and braided into a suture. As for wet spinning the chitin was dissolved in hexafluoroacetone sesquihydrate and pumped through a 20 hole, 100 microns diameter spinneret into an acetone bath which was maintained below room temperature. The coagulated wet gel was pulled away from the spinning head and washed counter-currently with acetone, then wound on a reel and subjected to vacuum at 50°C until substantially all of the solvent was removed. The fibres were hot stretched, then braided into a suture and sterilized by autoclaving at 30 lbs steam for 15 minutes and packaged. The fibre properties were not reported but the sutures were said to work and to be absorbable.

So far all the solvent systems used for dissolving chitin are acid based, some of which are either very corrosive or expensive. The discovery of the aprotic solvent systems for chitin in about 1978 was an important breakthrough in chitin research [95]. The systems involve the use of certain amides in conjunction with lithium chloride to dissolve chitin. The systems have been found to provide the only media in which chitin is not hydrolysed. According to the report, only dimethylacetamide (DMA) and N-methyl-2-pyrrolidone (NMP) or mixtures of these amides in conjunction with LiCl dissolved chitin. No other lithium salts were effective. Additionally, no other amide, not even DMF (despite its structural similarity with DMA) could dissolve chitin when substituted for DMA or NMP. Under the conditions reported, 2-5 wt % of LiCl in DMA or NMP were used to dissolve 2-5 wt % chitin either at room temperature or on moderate heating eg. at 50°C . The solutions were stirred using

heavy duty mixers, and were filtered by centrifuging, vacuum or pressure filtration. It was observed that chitins from different sources show variations in their solubilities presumably due to differences in their molecular weights. In all the cases, it appeared that not all the chitin could be dissolved in the systems. However, one interesting feature of the systems was the observation that most of the solutions were optically active. Table 1.8 shows the solubility of different chitins and the optical activity of chitin solutions, and the tensile properties of chitin films and fibres from different sources as reported by Rutherford and Austin [57]. The details of the spinning procedure were not given. However, a detailed procedure for preparing films was given and involved the following essential features:

- (i) After spreading on a glass plate, the film was dried in a current of air at room temperature for 1 hour and then placed in excess acetone for 16 hours.
- (ii) The film was further extracted for 24 hours with fresh acetone, rinsed again with fresh acetone and finally dried in air at room temperature for 30 minutes.
- (iii) The film was cut into small strips and these were then cold drawn.

It was claimed that a film cast from a solution stored for 48 days was capable of being cold drawn to about 75%. It was further suggested that the horseshoe crab and red crab provided a source of superior chitin and chitin from brown shrimp isolated under mild conditions also appeared to be of high quality.

Recently, Nakajima et al [96] briefly reported the production of fibres from an amide-LiCl system. The chitin obtained from red crab was purified and slightly modified before dissolving in amide-LiCl to

TABLE 1.8: The solubility of different chitins, the optical activity of their solutions, and the tensile properties of their films and fibres [57]

Chitin	Solubility %	Optical activity ^a (α) ₀ ²⁵	Tensile properties		
			Cold drawn (%)	Tensile strength	
				kg/mm ²	g/dtex ^b
Horseshoe crab	82	-56	-	60	4.30
Blue crab	58	+33	83,45	22,17	1.57,1.21
Dungeness crab	30	-	52,52	32	2.29
Red crab	76	+23	114,154,116	35,31	2.50,2.21
Pink shrimp	62	+75	50,60,55	24	1.71
Brown shrimp	92	-39	123,123	24	1.71

a initial optical activity

b assuming that density = 1.4 g/cm³

make dope. The details of the process were not reported. Fine filaments of about 5 μm in diameter were claimed to have been spun from spinnerets of 0.05 mm (50 μm) diameter using butyl alcohol as coagulant. The multifilaments were claimed to have tensile strengths of about 50 kg/mm^2 (3.57 g/dtex), though no extensibilities were quoted. The filaments were used as sutures and found to be very comparable with other sutures such as polyglycolic acid, though their extensibilities were lower.

In 1984 (part way through the present study), a new approach to the wet spinning of chitin fibres using trichloroacetic acid alone or in conjunction with methylene chloride as solvent was patented by Kifune et al [97]. The essential features of the process were as follows:

(i) The dope was prepared at 5 $^{\circ}\text{C}$ using 1-10% by weight of chitin (3-5% chitin was used in their examples), then filtered and degassed under reduced pressure.

(ii) The dope stored below 10 $^{\circ}\text{C}$ was extruded through spinneret holes 40-60 μm in diameter into a coagulation bath (10-40 $^{\circ}\text{C}$) containing anhydrous methanol or acetone.

(iii) The partially coagulated filaments (with 10-50 wt % solvent) were taken out at mostly 10-15 m/min (spinning draft 0.4-1.4) and subsequently dropped into either of the apparatus shown in Figs. 1.17(a) and 1.17(b) containing methanol alone or with 0.3 g/l caustic potash. In fact, any coagulant used in the spinning bath was claimed suitable.

(iv) With reference to Fig. 1.17(a), the filaments (1a) were dropped onto a conveyor (3) by the roller (2) to form a heap of filaments (1b). The conveyor immersed in the second coagulation bath (4) was run at a rate 0.5 m/min slower than the speed of roller (2), so that no tension

FIG. 1.17: Schematic diagram of apparatus for obtaining tensionless filaments necessary for high tenacity chitin fibres [97]

Fig. 1.17(a)

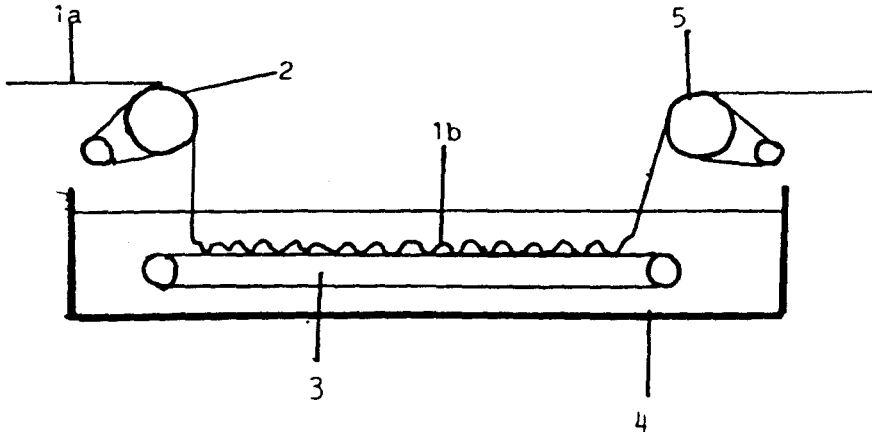

- 1a - filament
- 1b - heap of filament
- 2 - roller
- 3 - conveyor
- 4 - second coagulation bath

Fig. 1.17(b)

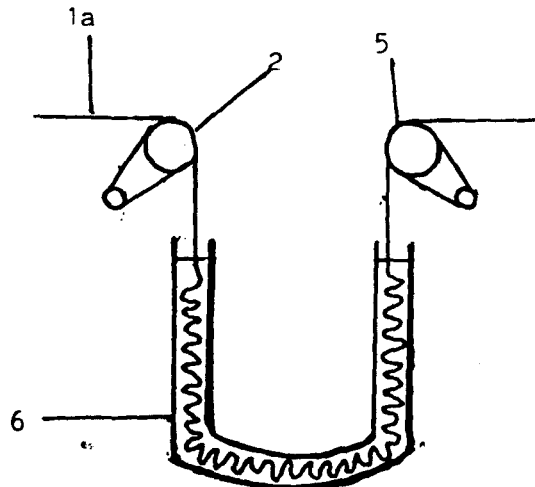

- 5 - roller
- 6 - u-shaped tube

was exerted on the filaments. The filaments were removed from the bath by a roller (5). Alternatively, a u-shaped tube (6) shown in Fig. 1.17(b) was used instead of bath (4) and the filaments passed through were relaxed and untensioned as described above. The u-tube should also contain a coagulant.

(v) The filaments were wound onto a bobbin or formed into a cake and further stored in a coagulant for different lengths of time, preferably overnight, or stretched by about 20-40% before winding.

(vi) The wound filaments were neutralized in aqueous caustic potash (0.3-0.5 g/l) for 1 hour, washed with water until neutral, centrifuged and dried under reduced pressure at room temperature overnight.

Although a wider range of spinning conditions were quoted in the patent, typical conditions used in the examples given are shown in Table 1.9(a) with the respective fibre tensile properties (Table 1.9(b)). For the first time it was possible to produce chitin fibres with high tenacities and extensibilities. The improvement was claimed to lie totally with the relaxation of the fibres, as fibres produced under tension were observed to have similar tenacities and extensibilities as were previously obtained by other workers. However, on most occasions, it was not clearly indicated whether or not the fibres were stretched after relaxation, although the low linear densities quoted suggests that some sort of stretching had taken place. Those fibres that were reported stretched by 20-40% had very high tenacities, though their extensibilities were not reported. Incidentally, it was further claimed that chitin powder suitable for the spinning process should have a bulk specific density of 0.4-0.28 g/cm³ (under a load of 42 g/cm²), and a viscosity of 300-1,500 cP at 30°C for a 0.2% by weight chitin dissolved

TABLE 1.9(a): Spinning conditions used in Kijune et al patent [97]

Example	1				2	3	4	5	6	7	8	9
	A	B	C	D								
Dope concentration (parts by wt)	3	3	3	3	3	3	3	3	3	3	5	3
Dope temperature in reservoir (°C)	<10	<10	<10	<10	<10	<10	<10	<10	<10	<10	<10	<10
Dope temperature in spinneret zone (°C)	20	20	20	20	20	20	20	20	20	20	35	20
Spinneret size	40x80 μ	40x80 μ	40x80 μ	3x150 μ	30x70 μ	30x70 μ	30x70 μ	30x70 μ	30x70 μ	40x80 μ	40x50 μ	40x70 μ
1st coagulation bath: coagulant	Ace	Ace	Ace	Ace	MeOH	MeOH	MeOH	MeOH	MeOH	Ace	Ace	Ace
temperature (°C)	14	14	14	14	16	16	16	16	16	14	30	14
2nd coagulation bath: coagulant	MeOH	MeOH	MeOH	MeOH	0.3 g/l KOH MeOH	0.3 g/l KOH MeOH	0.3 g/l KOH MeOH	0.3 g/l KOH MeOH	0.3 g/l KOH MeOH	MeOH	MeOH	MeOH
temperature (°C)	15	15	15	15	-	-	-	-	-	15	15	15
Take-up roller speed (m/min)	10	10	10	10	15	15	15	15	15	10	10	10
Conveyor speed (m/min)	0.5	-	-	0.5	-	-	-	-	-	0.5	0.5	0.5
Conveyor replaced by roller onto which filament wound 20 times	-	no winds but 20 wnds tensioned	-	-	-	-	-	-	-	-	-	-
Draw ratio	-	-	-	-	-	-	-	-	-	1.4	1.2	-
Wind-up speed (m/min)	9	9	9	9	-	-	-	-	-	9	9	9
Soaking time					1 min	10 min	1 h	10 h	24 h	-	-	-

55

TABLE 1.19(b): Fibre properties quoted in Kijune et al patent [97]

	1				2	3	4	5	6	7	8	9
	A	B	C	D								
Single yarn linear density (d)	1.8	1.7	1.65	35.5	2.13	2.03	2.0	2.0	1.96	1.16	1.05	1.75
Single yarn tensile strength (g/d)	3.10	1.65	1.67	2.90	2.25	2.98	3.21	3.16	3.20	4.10	4.35	3.15
Elongation (%)	20.0	8.7	8.8	18.0	19.2	26.9	25.8	28.4	27.3	-	-	19.4

Ace, Acetone; MeOH, Methanol

in DMA-10% LiCl. (It is quite unimaginable what the viscosity of a 10% chitin solution would be, if a 0.2% solution in DMA/10% LiCl had a range of viscosity as high as 300-1,500 cP, except if as Tokura et al [93] indicated chitin degraded very rapidly in the solvent.)

1.10 Fibre production from chitin derivatives

The early attempts to develop fibres from chitin were not very successful. By the end of the 1970s not much progress had been made and attention was turned to chitin derivatives. The preparation of acetylchitin fibres, alkyl-chitin fibres and highly deacetylated chitin (54% deacetylated) fibres have been carried out successfully.

Tokura et al [98] reported the preparation of various acetylated chitin fibres from acetyl chitin prepared according to the procedure of Nishi et al [75]. A comparison of the properties of the fibres with those of chitin fibres obtained from chitin viscose [90] or a chitin-formic acid solution [93] was made. Solutions of acetylated chitin were prepared in 99% formic acid by freezing at -20°C for 24 hours with a small addition of dichloroacetic acid or an organic solvent. The solubility was found to depend on the degree of acetylation. Diacetyl chitin dissolved completely in 99% formic acid up to a concentration of 20% with only stirring. However, a solution of good spinning quality was obtained only after addition of ethylene chloride or diisopropyl ether. On the other hand, the 1.1 acetylchitin required repeated freezing and addition of dichloroacetic acid to dissolve.

The viscosity of a normal spinning solution was quoted at about 100 poise estimated by the ball fall method. The solution was filtered and spun at a pressure of $0.4-1.3 \text{ kg/cm}^2$ through a $90 \mu\text{m}$ diameter

spinneret into diisopropyl ether (1st coagulation bath, at room temperature). The partially coagulated filaments were then passed through the 2nd coagulation bath (at room temperature) containing 50% acetic acid:ethanol (2:5 v/v) and stretched in water (10°C or 60°C). The filaments were wound on a cassette, immersed in boiling water for 1 hour and washed thoroughly under running water overnight and finally dried in air. The spinning conditions and the properties of the fibres are shown in Tables 1.10(a) and 1.10(b) respectively. The results indicated a progressive improvement in the tensile properties with increasing degree of acetylation up to an optimum value at a degree of acetylation of 1.1 and then decreased. The 1.1 acetylated chitin fibre showed the maximum tenacity of 1.89 g/d (1.70 g/dtex) and an extension of about 12%. Acetylchitin fibres, when compared with the chitin fibres prepared, had a greater tenacity and elongation. Chitin fibres prepared had dry tenacities between 0.68 and 1.32 g/d (0.61-1.19 g/dtex) and extensibilities 2.7-2.9%.

In a separate study, Tokura et al [99] reported the preparation of alkyl-chitin fibres. Alkylation of chitin was achieved by a freezing process in a sodium hydroxide-sodium dodecylsulphate solution, followed by alkylation with various alkyl halides of different chain lengths and bulkiness. The fibres were prepared by spinning the solutions of alkyl-chitins in formic acid-dichloroacetic acid mixtures into ethyl acetate. The method used for spinning was similar to that earlier reported for the preparation of acetylchitin fibres except there was no drawing bath. The fibres were stretched in air immediately after the coagulation as they were reported to swell quickly and became fragile on absorbing water. The stretched fibres were immersed in ethanol containing sodium

TABLE 1.10(a): Spinning conditions for the preparation of chitin and acetylchitin fibres [98]

Sample number	1	2	3	4	5	6	7	8
Degree of acetylation	0	0.3	1.1	1.6	2.0	2.0 ^a	0	0.3
Solvent	FA:DCA	FA:EC	FA:DCA	FA:DCA	FA:EC	FA:EC	FA:DCA	FA
Solvent, v/v	92:8	2:1	75:6	12:1	2:1	2:1	92:8	
Polymer concn.% w/v	4.0	4.2	6.1	3.9	13.3	13.3	3.0	4.2
Spinning pressure kg/cm ²	1.3	0.6	0.4	1.3	0.8	1.0	1.2	1.2
Spinneret	Pt, 0.09 mm (90 μm), 50 holes							
Coagulation bath: 1st	Diisopropyl ether						Ethyl acetate	
2nd	50% Acetic acid:Ethanol(2:5 v/v)						Ethanol	
Draw bath(water)	60°C			10°C			60°C	
1st roller, m/min	5.2	5.7	5.7	5.6	5.7	5.7	5.6	5.6
2nd roller, m/min	5.8	6.5	7.5	7.7	8.2	8.2	7.3	7.3
Draw ratio	1.10	1.14	1.32	1.38	1.44	1.44	1.30	1.30

a Prepared by perchloric acid method. The others were by methanesulphonic acid method.

FA: 99% formic acid; DCA, dichloroacetic acid; EC, ethylene chloride.

TABLE 1.10(b): Properties of chitin and acetylchitin fibres [98]

Sample number	1	2	3	4	5	6	7	8
Tenacity (g/d)								
Dry	0.68	0.94	1.89	1.52	1.13	1.48	1.32	1.73
Wet	0.23	0.33	0.75	0.58	0.50	0.56	0.18	0.74
Elongation (%)								
Dry	2.9	5.7	11.7	5.3	7.5	7.0	2.7	3.7
Wet	10.8	13.7	22.7	12.9	14.1	15.4	7.8	15.6
Young's modulus (g/d)								
Dry	42.7	45.9	55.7	75.2	49.7	64.0	71.5	70.8
Wet	2.4	2.5	6.0	6.4	3.4	4.7	2.7	5.5
Knot strength ₃ (g/d)	0.45	0.44	0.64	0.39	0.14	0.31	0.45	0.41
Density (g/cm ³)	1.347	1.355	1.328	1.315	1.244	1.313	1.382	1.388
Moisture recovery (%)	13.0	13.9	11.9	9.3	8.5	9.5	12.9	21.3
Count (d)	3.2	3.6	4.0	4.3	12.5	13.1	25.5	50.1

hydroxide, then washed in fresh ethanol and finally dried in air. The properties of the fibres as reported by Tokura et al are shown in Table 1.11. The results indicate that alkylation of chitin did not improve fibre properties. Alkylated fibres produced had tenacities between 0.60 and 1.42 g/d (0.54-1.28 g/dtex) and extensions of 1.0-4.6%. However, it was claimed that the orientation of butylchitin fibres was generally better than that of chitin fibres.

In more recent work, Tokura et al [100] reported the preparation of fibres from chitins containing hydrophilic alkyl group such as carboxymethyl-(CM) or dihydroxypropyl- (DHP) and partially deacetylated chitins. The spinning solutions (CM- and ~~DHP~~-chitins were prepared as earlier indicated for chitin and acetylated chitin by repeated freezing in 99% formic acid and dispersing with dichloroacetic acid. The deacetylation of chitin was achieved in i-propanol-55% (w/v) aqueous NaOH mixture at 90-100°C for 1 to 3 hours. The partially deacetylated chitin solution was prepared by dissolving in 4% aqueous acetic acid (100 ml) at room temperature. The solution was frozen at -20°C for 12 hours to give a good dispersion, and then melted, filtered and the viscosity adjusted to 100 poise by the addition of 4% acetic acid solution. The fibre was prepared by spinning the solution into copper-ammonium coagulant (2 M - CuSO_4 :Conc. NH_4OH ; 1:1 (v/v), 70 cm bath length) through a spinneret 0.2 mm diameter, 30 holes at a speed of 11.3 m/min. The fibre was then passed through a 50% aqueous ethanol bath (2nd coagulant, 70 cm bath length) and wound at a speed of 15.0-17.0 m/min after passing through water. The fibre was treated with 0.1 M EDTA at 70-80°C for 2 hours, washed thoroughly in deionized water and dried in air.

TABLE 1.11: Properties of chitin and alkyl-chitin fibres [99]

Sample	Denier (d)	Tenacity (g/d)		Elongation (%)		Knot strength (g/d)	Young's Modulus (g/d)		Density (g/ml)	D. sub. ^c
		Dry ^a	Wet ^b	Dry	Wet		Dry	Wet		
Chitin	8.54	1.28	0.23	8.4	15.6	0.15	74.54	3.96	1.40	0
Chitin	4.16	1.39	0.33	3.6	10.1	0.64	88.42	19.42	1.40	0
Methyl-	3.73	0.60	0.06	4.2	3.5	0.20	45.80	-	1.37	0.4
Ethyl-	2.99	1.25	0.33	3.5	13.2	0.32	86.12	3.40	1.39	0.4
n-Butyl-	4.15	0.79	0.10	1.0	7.1	0.11	108.26	-	1.43	0.4
i-Butyl-	5.58	1.42	-	4.6	-	0.12	92.72	-	1.44	0.4
t-Butyl-	3.56	0.92	-	3.5	-	0.15	86.52	-	1.41	0.4
n-Amyl-	4.23	0.92	-	3.5	-	0.38	88.70	-	1.46	0.4
i-Amyl-	3.69	1.20	-	3.5	-	0.13	102.79	-	1.41	0.4
t-Amyl-	2.53	0.82	0.09	2.5	17.3	0.48	89.57	-	1.42	0.4

a Dry: 20°C, 65% R.H.

b Wet: 20°C, 100% R.H.

c D.sub: Degree of substitution estimated from elemental analysis

The fibres from CM-chitin and DHP-chitin were prepared by spinning their solutions into acetone (1st coagulant, bath length: 70 cm) at a speed of 6.3 m/min through spinnerets 0.1-0.2 mm diameter, 30-50 holes at room temperature. Aqueous ethanol (50%) was used as a 2nd coagulant and the fibres were wound at a speed 7.6-9.0 m/min after they were stretched in water. The fibres were treated in boiling water for 2 hours to remove acids, then treated in ethanol containing NaOH for 12 hours and finally washed in ethanol and dried in air.

The tensile properties of the fibres from chitin, acetylchitins and alkylchitins including CM- and DHP-chitins and those of deacetylated chitin are shown in Table 1.12. The fibres from deacetylated chitin were shown to have the best tensile properties of 2.41 g/d (2.16 g/dtex) tenacity and 9.3% extensibility in the dry state and 1.32 g/d (1.19 g/dtex) tenacity and 7.1% extensibility in the wet state. The tensile properties of all the alkyl-chitin fibres were not measured in the wet state owing to their hygroscopic character. The important property of CM- and DHP-chitin fibres reported was their accessibility to lysozyme. The optimum pH for hydrolysis of these fibres by lysozyme was suggested to be pH 6.0 at 50°C and the rate of DHP-chitin hydrolysis was slightly higher than that of CM-chitin provided both were water soluble. Water solubility was obtained at a degree of carboxymethylation of over 0.6 and that of dihydroxypropylation of over 0.9 per N-acetylglucosamine residue, although the fibres prepared were not water soluble as the degrees of substitution were 0.4 and 0.8 respectively.

TABLE 1.12: Comparison of tensile properties of chitin, acetylchitin and alkylchitin fibres as reported by Tokura et al [100]

Fibre	Denier (d)	Tenacity(g/d)		Elongation(%)		D.S.
		Dry	Wet	Dry	Wet	
Chitin	8.5	1.28	0.23	8.4	15.6	0
Chitin	4.2	1.39	0.33	3.6	10.1	0
Acetyl-chitin	3.6	0.94	0.33	5.7	13.7	0.3
	4.0	1.89	0.75	11.7	22.7	1.1
	12.5	1.13	0.50	7.5	14.1	2.0
	13.1	1.48	0.56	7.0	15.4	2.0
n-Butylchitin	4.2	0.79	0.10	1.0	7.1	0.4
i-Butylchitin	5.6	1.42	-	4.6	-	0.4
t-Butylchitin	3.56	0.92	-	3.5	-	0.4
CM-chitin	4.3	1.26	-	5.2	-	0.4
DHP-chitin	6.3	1.18	0.62	7.8	12.3	0.8
Deacetylated chitin	4.7	2.41	1.32	9.3	7.1	54%*

D.S.; degree of substitution estimated from elemental analysis

* degree of deacetylation

1.11 Aims of the study

The main objectives of this work were to investigate the production of fibres from chitin using wet spinning techniques, and if successful, to determine the optimum conditions for producing such fibres. The existing literature in this area indicates that such fibres may have applications particularly in the medical field such as sutures on account of the wound healing characteristics of chitin. The development of such fibres has been hampered by the lack of a suitable solvent. Recent studies have claimed, however, that mixtures of dimethyl acetamide-lithium chloride and N-methylpyrrolidone-lithium chloride are satisfactory solvents. In the present work, fibres were produced using dimethylacetamide-lithium chloride.

It was also the aim of this study to investigate whether mesomorphic phases ie. liquid crystals could be formed in chitin solutions by studying the rheological and solution properties as a function of temperature and concentration of the chitin. Liquid crystal solutions are usually obtained from rigid chain aromatic polymers [101] and fibres obtained from such solutions have very high tenacity and modulus. It has been known for sometime now that cellulose and chitin have the capacity to form liquid crystal solutions [103]. Only recently it was shown that cellulose in N-methylmorpholine N-oxide possesses liquid crystal characteristics [102,104,105]. Furthermore, high tenacity/high modulus fibres have been produced from liquid crystal solutions of cellulose triacetate in trifluoroacetic acid (TFA)/water or TFA/formic acid or TFA/methylene chloride [106].

CHAPTER 2

MATERIALS AND GENERAL EXPERIMENTAL METHODS

2.1 Materials

Chitin

Several samples of chitin were used in this study, all extracted from blue crab. The first sample was supplied by G.D. Searles Ltd., [56] and was ground to 20 mesh (C1). The second sample, also from G.D. Searles Ltd., was a coarse presumably unground sample (C2). The third sample was supplied by Polysciences (practical grade lot 1817) (C3).

Before spinning, the samples were usually further purified/depolymerised to give a variety of different samples, coded as shown in Table 2.1.

Chemicals

All chemicals were obtained from B.D.H. except where indicated and were first grade laboratory reagents, used without further purification.

2.2 Characterisation of chitin

2.2.1 Solubility

The solubility was determined by stirring 0.1 g chitin in 50 ml DMA containing 4 g (8% w/w) anhydrous lithium chloride (LiCl) overnight (>16 hours) at room temperature. The mixture was filtered through a sintered glass crucible (porosity 1), and the amount of the dissolved material was determined using both the following methods. Firstly, the residue was washed successively in dimethyl acetamide (DMA), distilled water, methanol and acetone and dried to a constant weight in an oven at 80°C. Secondly, the dissolved chitin was precipitated with water while stirring continuously with a magnetic stirrer. The precipitate was left

TABLE 2.1: Samples of chitin used and their codes

Source	Original samples (untreated)	Time of treatment (h)/coded numbers				
		0.5	2	4	6	7
Searles	C1	C1-0.5	C1-2	C1-4	C1-6	C1-7
"	C2	C2-0.5	C2-2	C2-4	C2-6	C2-7
Polysciences	C3	C3-0.5	C3-2	C3-4	C3-6	C3-7

stirring for a further 30 mins, after which it was filtered (porosity 2), washed three times with distilled water, once in methanol and acetone, and then dried at 80°C to constant weight.

2.2.2 Solution viscosity measurements

The viscosity measurements were carried out in a u-tube viscometer, type B. The required quantity of LiCl (8.2 g corresponding to 8%, w/w) was rapidly weighed into a dry 150 ml glass stoppered conical flask, which was stoppered tightly to exclude moisture. The LiCl was then dissolved in 100 ml of DMA, and the solution filtered through a sintered glass crucible (porosity 1) into another flask. Exactly 50 ml of the filtered solvent was pipetted into a 100 ml glass stoppered conical flask containing an accurately weighed sample of chitin; 0.125 g for the original chitin, 0.5 g in the case of degraded samples. The flask was stoppered and stirred for about 5 hours. The mixture was filtered (porosity 1) into another flask, which was then stoppered immediately. The concentration of the filtered solution was determined from the undissolved material as described in section 2.2.1.

The required amount of the filtered solution (about 18 ml) was transferred into the dry viscometer using a long narrow pipette. The level of the solution in the viscometer was adjusted to the mark by means of a syringe with a long needle. The viscometer was then placed in a thermostat bath at 25°C allowing 30 mins to attain the bath temperature and any volume adjustments made if required. A stop watch accurate to 0.01 sec was used, and three flow times checking within 0.2 sec were normally obtained. The solution was poured out and the viscometer was rinsed three times with portions of the new filtered solution which had been prepared by diluting 25 ml of the original solution to 50 ml. By

such successive dilutions, solutions of varying concentration were prepared. At the end of the solution flow time determinations, the viscometer was drained, rinsed with solvent and then with water to precipitate and remove most of the residual chitin. After further washing with chromic acid for 2 hours, the viscometer was washed well with water, rinsed with acetone and dried. After this, the flow time of the solvent was then determined. (This procedure was adopted because all suspended level viscometers available had excessively long flow-times.)

From the flow times of the solvent and the solutions with different concentrations the relative viscosity, specific viscosity and viscosity number were calculated from the following formulae:

$$\text{relative viscosity} = \eta_r = \frac{t_s}{t_o} \quad (2.1)$$

$$\text{specific viscosity} = \eta_{sp} = \eta_r - 1 \quad (2.2)$$

$$\text{viscosity number} = \eta_{sp}/c \quad (2.3)$$

where

t_s = flow time of dilute solution of polymer

t_o = flow time of solvent

c = concentration of polymer solution in g/100 cc (g/dl)

By plotting the viscosity number against concentration, the intrinsic viscosity, $[\eta]$, (or limiting viscosity number) was obtained from the intercept at the ordinate.

$$[\eta] = (\eta_{sp}/c)_{c \rightarrow 0} \text{ dl/g} \quad (2.4)$$

This technique is based on the equation of Huggins [107].

$$\eta_{sp}/c = [\eta] + k[\eta]^2/c \quad (2.5)$$

where k is the Huggins constant.

As a check $[\eta]$ was obtained also from plots of $(\ln \eta_{rel})/c$ vs. c

The average molecular weight (\bar{M}_w) of polymer is related to $[\eta]$ according to equation (2.6) [108]:

$$[\eta] = K\bar{M}_w^a \quad (2.6)$$

where K and a are constants for a given polymer-solvent system at a given temperature. Though the constants have not been determined for chitin in DMA/LiCl, the values obtained for chitosan (acetyl content 9.1%) in 0.2 M acetic acid/0.1 M sodium chloride/4 M urea [79] are frequently used [57,80] in the determination of molecular weights (equation 2.7):

$$[\eta] = 8.93 \times 10^{-4} \bar{M}_w^{0.71} \quad (2.7)$$

2.2.3 Infra-red spectroscopy

Infra-red spectroscopy was done on thin films prepared from well filtered solutions of 2% (w/w) chitin in DMA/8% (w/w) LiCl. The film was prepared similarly to the procedures used at the University of Delaware [95] by pressing a small quantity of the solution between a slide and coverslip. The liquid film was dried for 15 minutes at room temperature in a current of filtered air. It was then placed in methanol for 24 h, rinsed twice in fresh methanol and in acetone and finally dried in air. Before use, it was stored in a desiccator containing phosphorus pentoxide for more than seven days. The film was then mounted

between two NaCl cells and placed in the sample beam of the infra-red spectrophotometer (Unicam SP 1025). Nothing was placed in the reference beam, since the only absorbing material in the cell was the film whose spectrum was being determined. After obtaining a suitable spectrum, the sample was removed and the spectrum calibrated with polystyrene film. The polystyrene film was placed in the sample beam, and a portion of the polystyrene spectrum (around 1601 cm^{-1}) was recorded on the chitin spectrum where calibration was found necessary.

In addition spectra of a treated chitin sample (C2-2) were kindly produced by J. Moore of the Biophysics Department, Leeds University, after treatment for various times in D_2O .

2.2.4 Optical activity

The method used for the determination was similar to that described by Rutherford and Austin [57,95]. Chitin (1 g) was added to a solution of 100 ml of DMA/8% LiCl. The mixture was stirred for 1.5 h, filtered and the concentration determined as described in section 2.2.1. On some occasions aliquots (5 ml) were taken and centrifuged for 30 min at 26,000 rpm to obtain a fairly clear solution which was otherwise cloudy. The optical activity of the sample was measured at room temperature using a polarimeter (Mk II A) and a 10 cm tube. The polarimeter was checked with a 10% (w/v) aqueous solution of sucrose which has a standard specific rotation of $[\alpha]_{\text{D}}^{20} + 66.4^\circ$ (as quoted by BDH) and a specific rotation of $[\alpha]_{\text{D}}^{25} + 65^\circ$ was obtained. The observed rotations (θ) measured were converted to specific rotations by equation (2.8):

$$[\alpha]_D^{25^{\circ}} = \frac{\theta}{l \times c} \quad (2.8)$$

where

$[\alpha]_D^{25^{\circ}}$ = specific rotation (in degrees using the sodium line at 589 nm)

θ = observed rotation (degrees)

l = path length(decimeters)

c = concentration (g/ml)

2.2.5 Measurement of the acetyl content

Many workers who have prepared chitin samples and compared their properties believe that the acetyl content influences the properties of the chitin [57]. Such properties as solubility, viscosity, tensile strength when in fibre form, moisture content and optical activity are claimed to be influenced, although no concrete evidence exists in support of such suggestions. However, it is the acetyl value that distinguishes chitin from chitosan. Several methods have been used to determine acetyl content, including spectroscopy (NMR and IR)[72,109,110] and chemical titrations [57,111,112].

In this work a titration procedure was used based on the work by Rutherford and Austin [57]. The principle is based on the hydrolysis of acetyl groups by strong alkali, to give, after acidification, acetic acid. The acetic acid is then distilled off as an azeotrope with water and titrated. The chitin sample (0.1 g) and 40 ml of 50% NaOH (12.5 N) was refluxed in a two-necked flask, heated in an oil bath at 130-140°C for 1.5 h using a vigreux column. After connecting a still head, a condenser and a 250 ml volumetric flask as receiver, the whole set up was well-lagged, and a total of 25 ml of orthophosphoric acid, H_3PO_4 (conc. 85%) was carefully added (1 ml every 2 min) to the flask through

a dropping-funnel. The temperature of the oil-bath was increased (200-220°C) and the mixture was distilled. When the flask began to go dry, 15-25 ml of hot distilled water was added to the flask with care through the dropping funnel, and this was repeated until 250 ml of distillate was collected in the 250 ml volumetric flask. Aliquots (25 ml) of the distillate were titrated with 0.01 N NaOH (standardised with potassium hydrogen phthalate (Analar)) using 4 drops of phenolphthalein as an indicator. The acetic acid content was then calculated for the total volume of the distillate.

To check the accuracy of the method, the experiment was repeated without chitin using a known concentration of acetic acid in the flask. 1 ml concentrated acetic acid (97.7%) was taken, diluted to 250 ml and standardised against 0.1 M NaOH. 5 ml of this solution (0.0752 M) was taken in the flask and distilled using the procedure described above. The acid content of the distillate was then determined by titrating with 0.01 N NaOH and the result compared with the original amount (ie. 3.76×10^{-4} moles). The value obtained was 3.46×10^{-4} moles, ie. about 10% low.

The percentage N-acetylglucosamine and the acetyl content of chitin were calculated using the following equations.

$$(a) \quad \% \text{ N-acetylglucosamine units} = \frac{100x \times 161}{161x + W - 203x} \quad (2.9)$$

where $x = \frac{v^0 \times m \times v^1}{1000 \times v}$ = number of moles of -NHCOCH_3 units

v^0 = volume (ml) of NaOH used for neutralization

m = exact molarity of 0.01 M NaOH

v^1 = total volume of distillate (250 ml in this case)

v = volume of distillate used for titration (25 ml)

W = weight of sample (~0.1 g)

$$(b) \quad \% \text{ acetyl} = \frac{43x}{W} \times 100 \quad (2.10)$$

Table 2.2 shows the relationship between percentage acetyl and percentage N-acetylglucosamine units. The values were determined based on equations 2.9 and 2.10. From these values a calibration curve was drawn as shown in Fig. 2.1. The curve served as means of converting one value to another since the two values are often quoted in the literature.

2.2.6 Measurement of the moisture content

The samples of chitin were conditioned for 24 h at 65% R.H./20°C and the moisture content determined using thermogravimetric analysis (TGA) on a DuPont 951 analyser. About 5-7 mg of sample was used, heated at a rate of 20°C/min in a nitrogen atmosphere (50 cm³/min).

2.2.7 Thermal analysis

The thermal stability and decomposition of both the untreated and treated chitin flakes were examined using TGA and a DuPont 990 Thermal Analyser (differential scanning calorimetry - DSC). The TGA was performed as described above (section 2.2.6). About 1.3 mg of sample was used for DSC, heated at a rate of 10°C/min in a nitrogen atmosphere (50 cm³/min).

2.2.8 Elemental analysis

Elemental analysis was carried out in the Department of Chemistry.

TABLE 2.2: Relationship between percentage acetyl
and percentage N-acetyl glucosamine units

% Acetyl glucosamine units	% Acetyl units
100	21.20
90	19.47
75	16.75
60	13.86
50	11.80
40	9.67
25	6.30
10	2.60
0	0.00

FIG. 2.1: Relationship between percentage acetyl and percentage N-acetyl glucosamine units

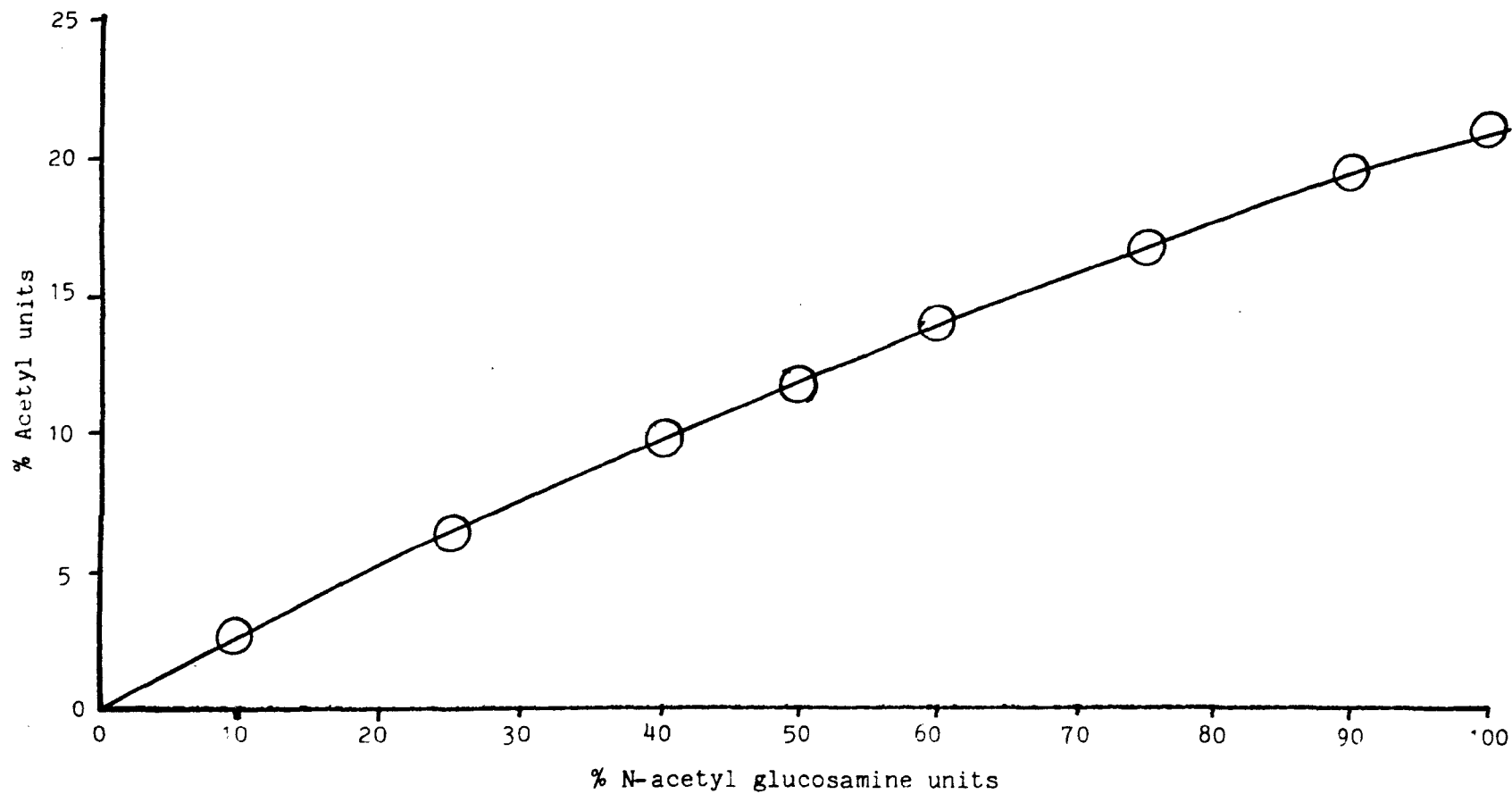

2.2.9 Solution characterisation by viscosity measurement

Measurements were carried out on a 'Haake Rotovisko' (RV12) cylinder type rotational viscometer. The apparatus consisted of a thermostatted sample chamber called a sensor (cup) into which fits, with only a small annular gap (1.45 mm), a concentrically aligned cylinder or bob. The bob, connected to the torque measuring head, was driven at a series of constant rotational speeds (1-512 rpm). Because the viscometer was equipped with a thermostatically controlled water or oil circulating bath, the viscosity measurements were carried out over a temperature range of 25°C to 80°C, using an SV1 sensor and M1500 measuring head. The viscosities of the chitin solutions were calculated as follows:

$$\text{Shear stress } (\tau) = A.V \text{ (Pa)}$$

where A = shear stress factor

$$= f(\text{SV1}) \text{ a (1500)}$$

$$= 253 \times 0.147 \text{ Pa/scale reading}$$

$$= 37.19 \text{ Pa/scale reading}$$

V = scale reading X sensitivity, E

(required value obtained by multiplying

the scale reading by the set step 'E')

$$\tau = 37.19 \times \text{scale reading(s)} \times E \quad (2.11)$$

$$\text{Shear rate (D)} = M N (\text{s}^{-1}) \quad (2.12)$$

where M = shear rate factor constant depending
on sensor system

$$= 0.89 \text{ min/s}$$

N = actual speed of the rotor (rpm)

$$= \frac{\text{set test speed}}{\text{reduction factor, R}}$$

$$\text{Viscosity } (\tau) = \text{shear stress/shear rate} \quad (2.13)$$

$$= \tau/D \text{ Pa s}$$

Units of viscosity

$$1\text{cP} = 1\text{mPa s} = 0.001 \text{ Pa s}$$

$$1\text{P} = 10^{-1} \text{ Pa s}$$

2.2.10 Purification/depolymerisation of chitin [56]

A clean dry 1000 ml flask was charged with toluene-4-sulphonic acid (TSA) (112.5 g, 15% w/v) and propan-2-ol (IP) (750 ml). After dissolving the acid, chitin (50 g) was added to the reactants and the flask was heated to 75°C in a water bath. After varying times, typically from 30 minutes to 7 hours, the chitin was filtered off, washed several times with distilled water and stirred at room temperature with 4% sodium hydroxide (750 ml) for 16-24 hours. The chitin was recovered by filtration, washed well firstly with distilled water until neutral to pH paper, and then with acetone. Finally the samples were dried under vacuum at room temperature for 24 hours.

It was observed that carrying out the above sodium hydroxide treatment before the acid-alcohol treatment produced flakes which were noticeably whiter than with the reverse procedure. Accordingly some

fibre spinning was carried out using a sample pretreated for 2 h in this way to detect any differences.

The treatment of chitin in TSA/IP was recommended by G.D. Searles Ltd. [56], but unfortunately no further information was given about the procedure. All attempts to find out who invented the procedure failed.

2.3 The spinning apparatus

The spinning apparatus consisted of a detachable main filtration unit, extrusion unit, coagulation bath, stretching bath and advancing reels, drying rollers and wind-up unit. Figure 2.2 and Plate 2.1 show respectively the schematic diagram and the photograph of the spinning apparatus.

2.3.1 The main filtration unit

To obtain a continuously spinnable chitin dope, it is extremely important that the dope be filtered properly. It was found that a pre-filtration using a candle filter not only improved the filtration process but also reduced the load on the filtering system behind the spinneret. The unit was actually a separate mobile extrusion unit on its own. It consisted of a dope reservoir with lid, metering pump and the candle filter. The dope reservoir had a capacity of about 4 litres and a lid which was pressed down on a Teflon washer by a clamp to prevent air entry. The lid had a nitrogen inlet which allowed the dope to be placed under pressure. Under pressure, the dope was forced via a copper tube to the metering pump (1 cc/rev, capacity). The metering pump had a speed range between 2-30 rev/min (2-30 cc/min) which was varied by means of a rotary regulator.

FIG. 2.2: The spinning line

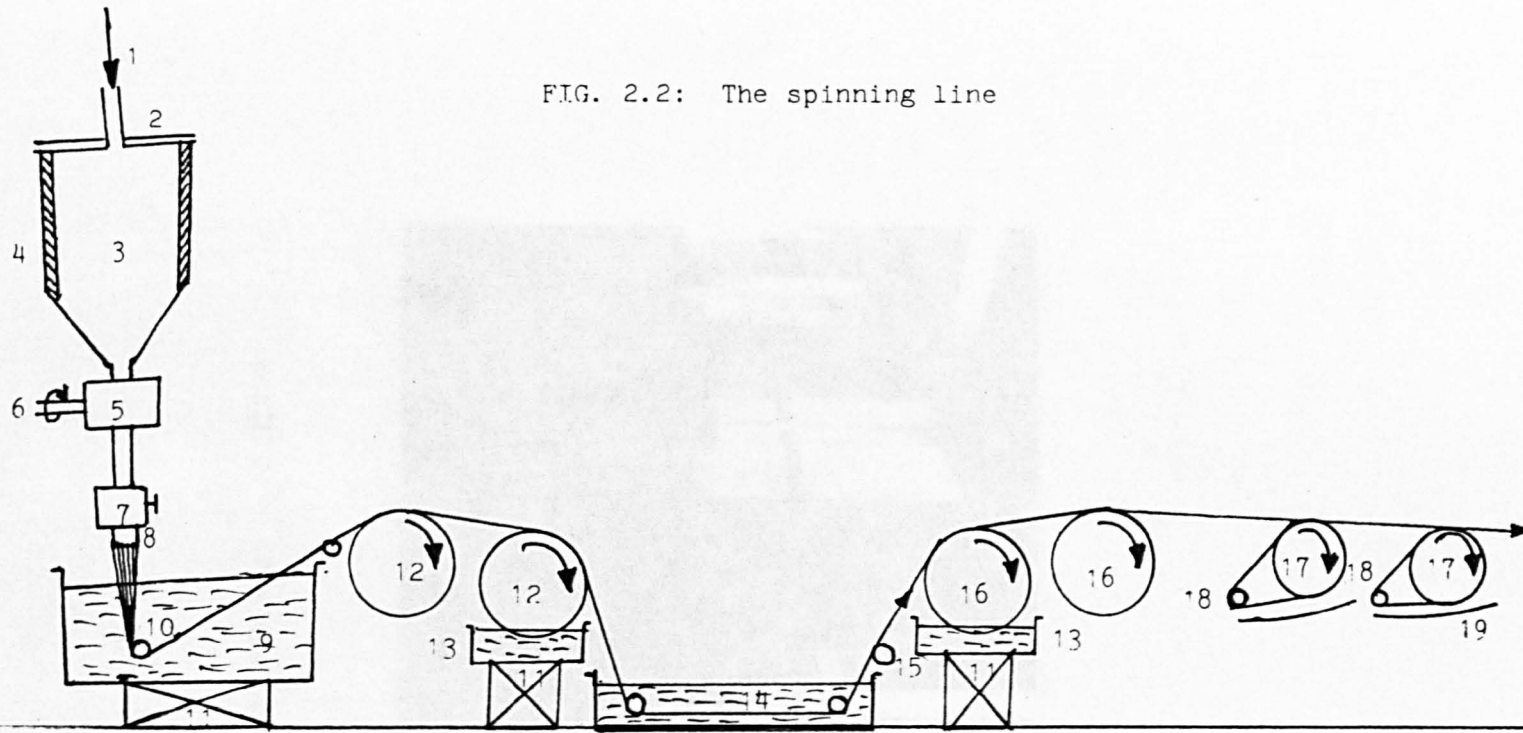

- 1. nitrogen inlet
- 2. reservoir lid
- 3. dope reservoir
- 4. heater
- 5. spinning block and metering pump
- 6. drive to the metering pump

- 7. spinneret holder
- 8. spinneret
- 9. coagulating bath
- 10. frictionless roller
- 11. adjustable stands
- 12. first pair of advancing reels
- 13. washing baths

- 14. hot water bath (washing and/or stretching)
- 15. thread guide
- 16. second pair of advancing reels
- 17. chrome rollers
- 18. idler rollers
- 19. radiant heaters

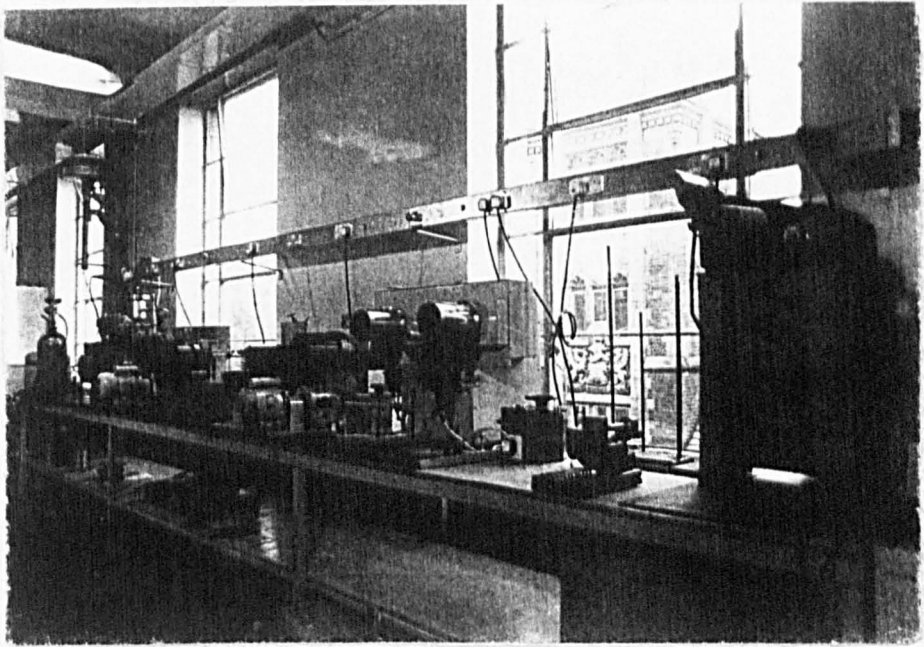

PLATE 2.1: The spinning equipment

The candle filter consisted of a thick layer of cotton tissue (gamgee) and a clean plain woven polyester fabric wrapped around the core and wired securely in position. The filter was screwed firmly to the metering pump through a copper tube, and a brass cylinder (the candle filter cover) was screwed over the filter. The arrangement was such that the whole assembly could also be unscrewed to release each part for cleaning or position adjustment when required. As the dope forced its way through the copper tube into the core of the filter, it was forced out through a number of holes in the side of the core. At the other end of the candle filter cover was a screw thread on which high pressure reinforced tubing was connected. The other end of the tubing was connected to a short pipe in the lid of the main extrusion reservoir which allowed the filtered dope to be collected directly in the reservoir. The gamgee and the fabric were replaced at every extrusion. Plate 2.2 shows the candle filter unit.

2.3.2 Extrusion unit

The extrusion unit is shown in Plate 2.3, together with the short coagulation bath (see section 2.3.3) and the first pair of advancing reels. The unit consisted of a dope reservoir of capacity 2 litres surrounded by a 1 Kw jacket-heater, which provided a means of varying the dope temperature. The reservoir was fitted with a lid which was screwed down onto a Teflon washer to make the whole reservoir air-tight, thus making it possible for the solution to be placed under vacuum for deaeration or under nitrogen pressure ($15-20 \text{ lb/in}^2$) from a nitrogen cylinder. The reservoir had a threaded lower exit tube which was screwed firmly into the spinning block. Like the reservoir, the spinning block

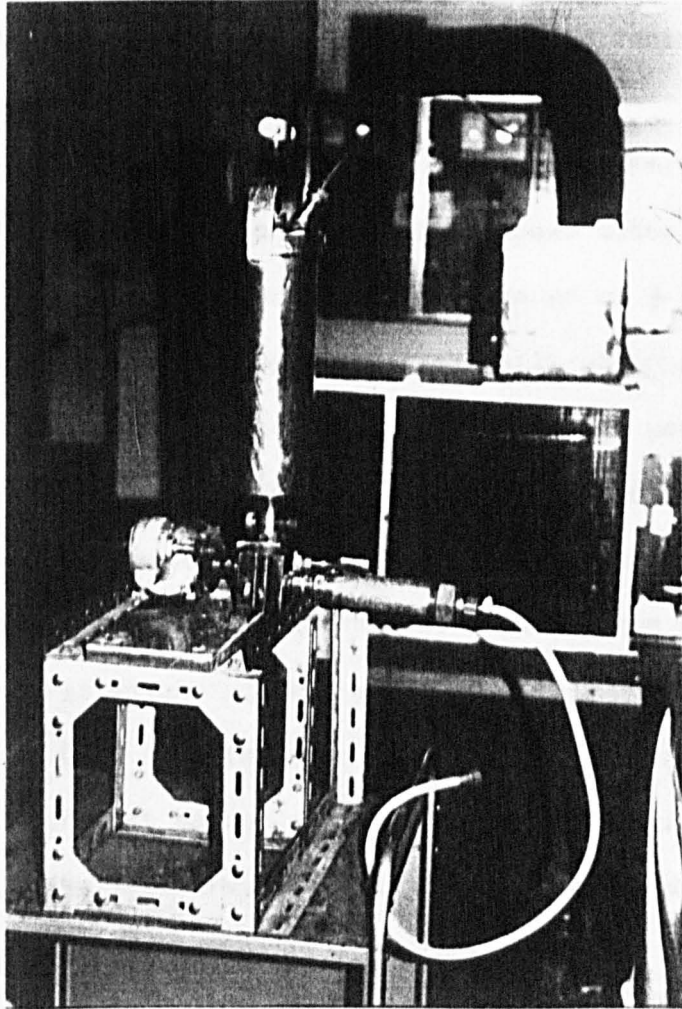

PLATE 2.2: The main filtration unit

could also be heated by means of two heating plates fitted on two sides of the block. Each plate had two pockets each fitted with a 150 watt cartridge heater, and one of the plates had an additional hole drilled for a thermistor. The dope and the block temperatures could be set and controlled independently by means of two separate temperature controllers, within the range of 20°C to about 400°C.

The metering pump (1.0 cc/rev) was held firmly to the spinning block and driven by a three phase variable speed motor. The speed of the metering pump could be varied within a range of 3-27 rpm (3-27 cc/min dope feed to the spinneret) by means of a built-up Kopp rotary regulator. Originally a pump with a capacity of 0.4 cc/rev was used, but due to excessive leakage it had to be replaced with the 1.0 cc/rev pump mentioned above. However, there were drawbacks with the higher capacity pump such as an inability to operate at speeds lower than 3 rpm and the high speeds at which the first advancing reel had to be set when using spinnerets of less than 90 μm hole size (section 2.4.2).

The spinneret holder was screwed to the lower side of the spinning block and held the spinneret assembly at its lower end. The spinneret assembly supported the spinneret and final filters. The assembly had the facility to be mounted either with the spinneret face vertical for wet-spinning or horizontal for dry-jet wet-spinning. Spinnerets ranging from 50 to 400 μm in hole diameter and with numbers of holes varying between 8 and 40 holes per spinneret were used for both wet and dry-jet wet spinning, though spinnerets with large hole diameters (above 150 μm) and relatively few holes (8 to 10) were mainly used for dry-jet wet spinning to prevent coalescence between neighbouring filaments. The holes in the spinneret were cleaned by:

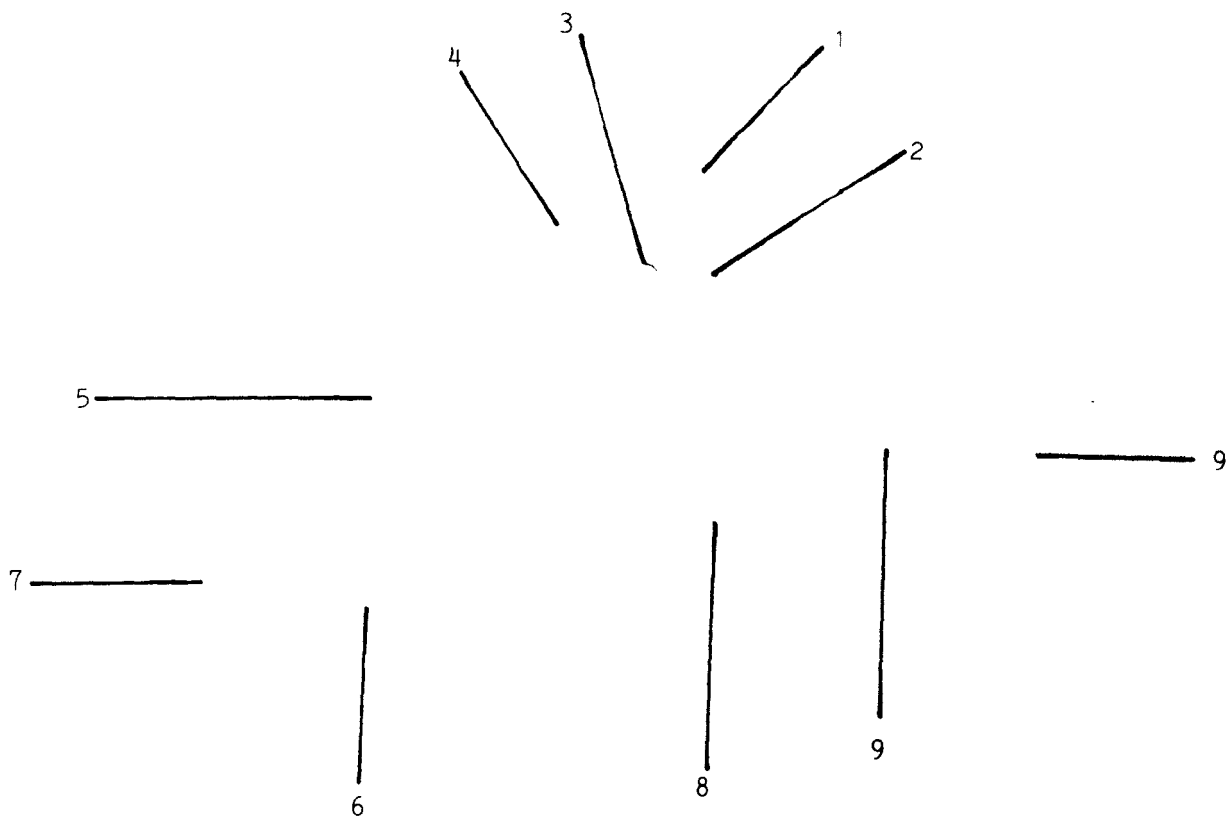
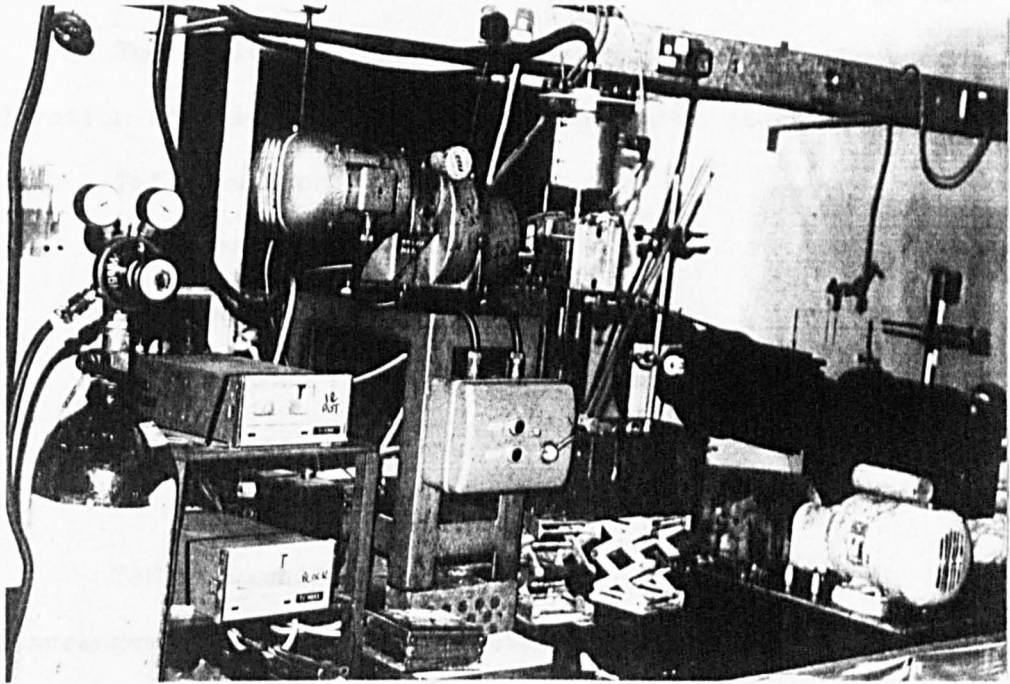

PLATE 2.3: Extrusion unit

1. dope reservoir (surrounded by a jacket heater)
2. spinning block
3. metering pump
4. variable speed motor
5. temperature controller (dope reservoir)
6. temperature controller (spinning block)
7. nitrogen cylinder
8. coagulation bath
9. advancing reels



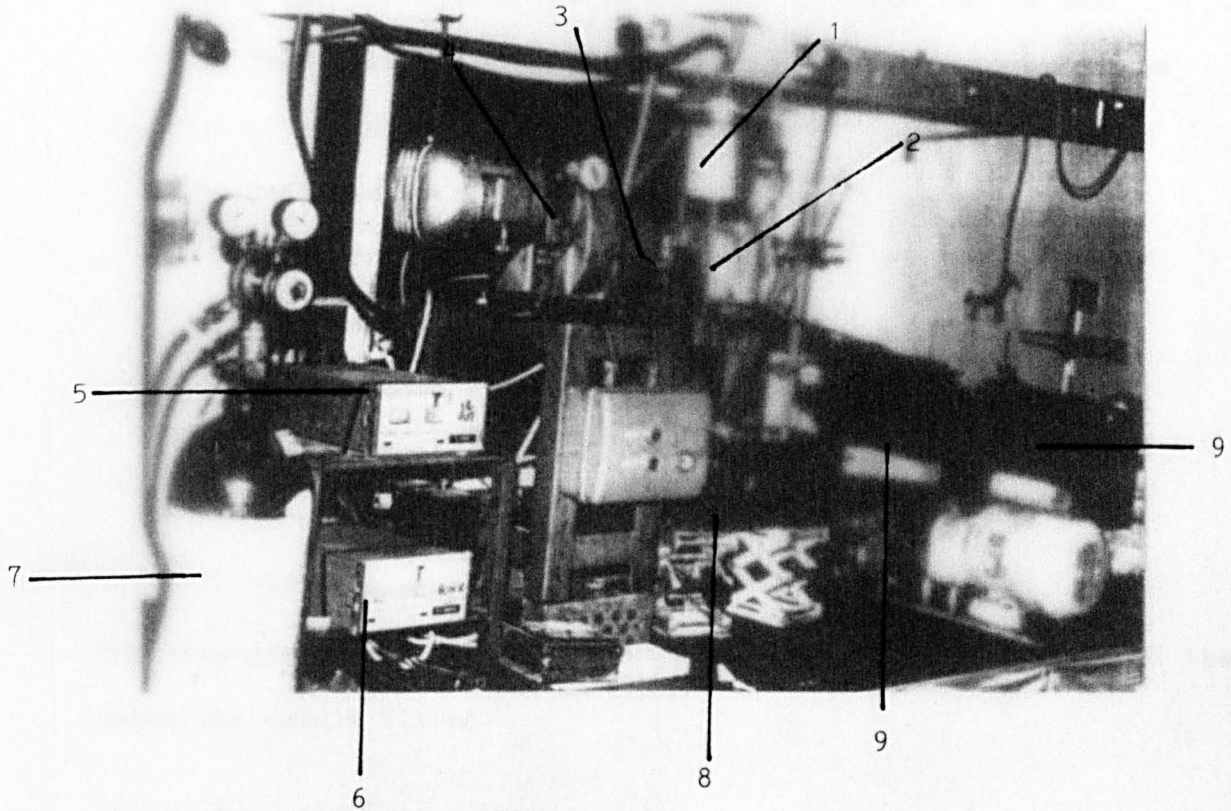

PLATE 2.3: Extrusion unit

1. dope reservoir (surrounded by a jacket heater)
2. spinning block
3. metering pump
4. variable speed motor
5. temperature controller (dope reservoir)
6. temperature controller (spinning block)
7. nitrogen cylinder
8. coagulation bath
9. advancing reels

- 1) treatment in an ultrasonic bath containing acetone or on rare occasions, DMA/LiCl when examination under the microscope showed blocked holes, and
- 2) storing all the spinnerets in chromic acid when not in use.

The following arrangement was found satisfactory for the filtration unit situated behind the spinneret (see Plate 2.4):

Teflon-washer

Spinneret

150 mesh/inch metal gauze

75 mech/inch fine woven polyester screen

Gamgee (cotton tissue)

75 mesh/inch fine woven polyester screen

Teflon-washer

The arrangement was only satisfactory after the pre-filtration of the dope using the candle filter.

2.3.3 The coagulation bath

Two static coagulation bath tanks were used. These were referred to as the short bath and the long bath.

(i) The short bath (Plate 2.5): This had an effective length of about 30 cm and was initially used for both wet spinning and dry-jet wet-spinning. Later it was used only for dry-jet wet-spinning. The bath was mounted on an adjustable stand, and inside it was a glass rod carrying a frictionless roller, both of which were fixed on a lab-lock. The rod was loosely clamped on a retort stand placed by the side of the bath. When bubble-free fluid filaments emerged into the bath from the spinneret, they were passed under the roller using a flexible metal wire (in the shape

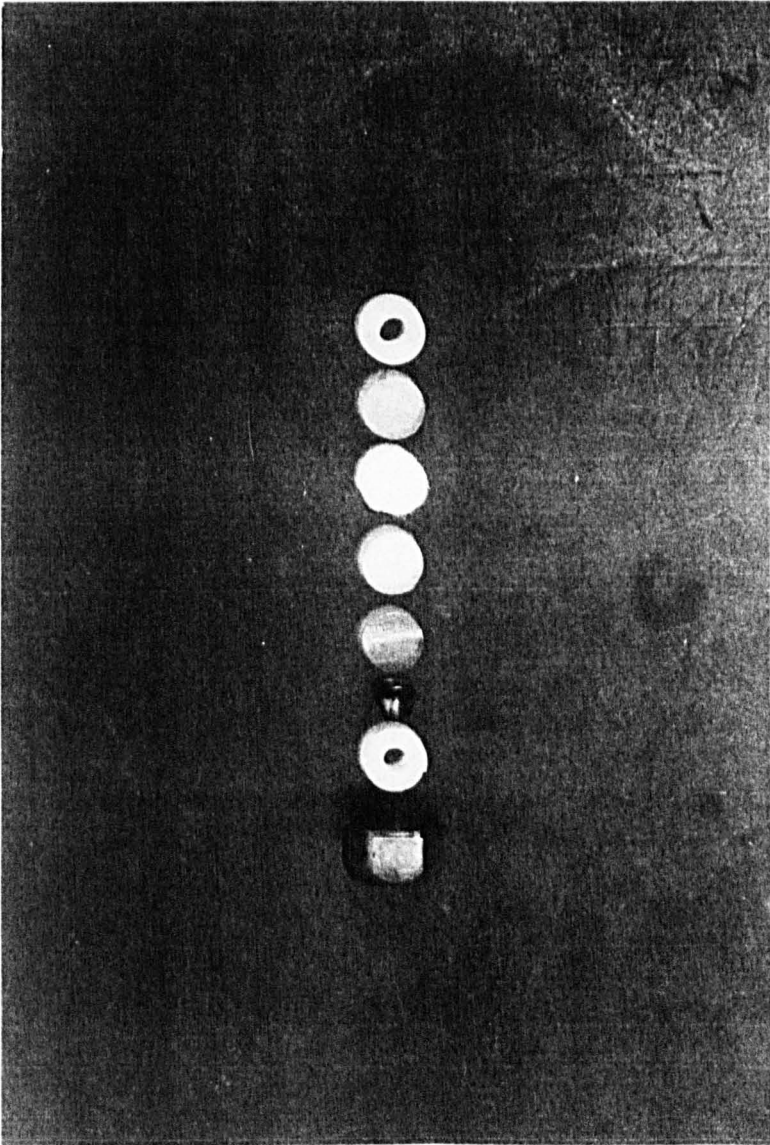

PLATE 2.4: Spinneret unit filtration arrangement assembly

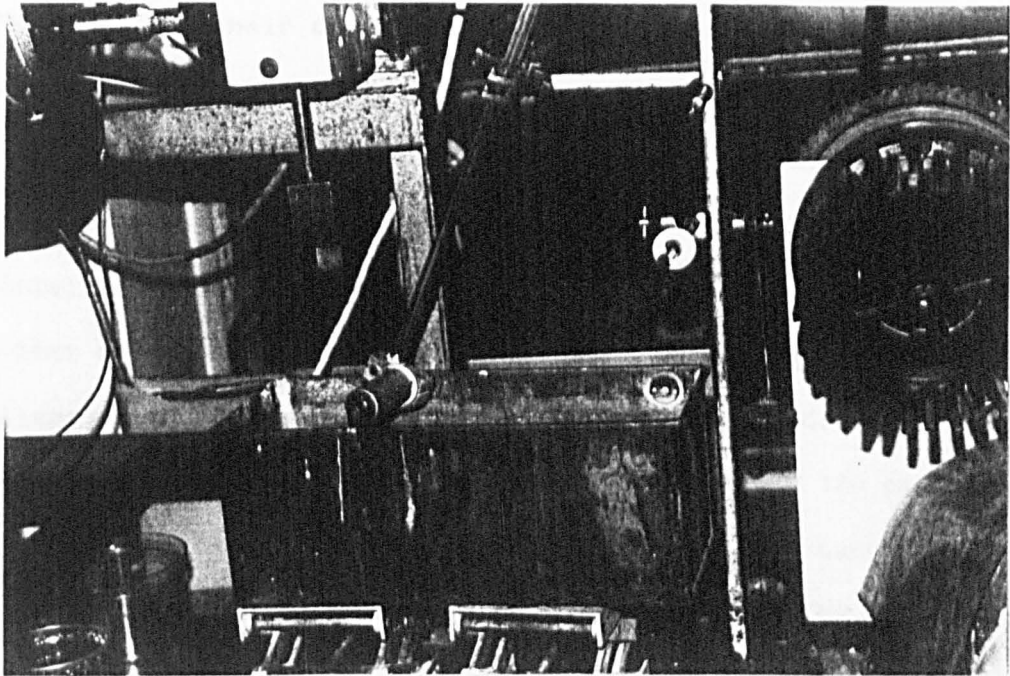

PLATE 2.5: The short coagulation bath (used mainly for DJWS)

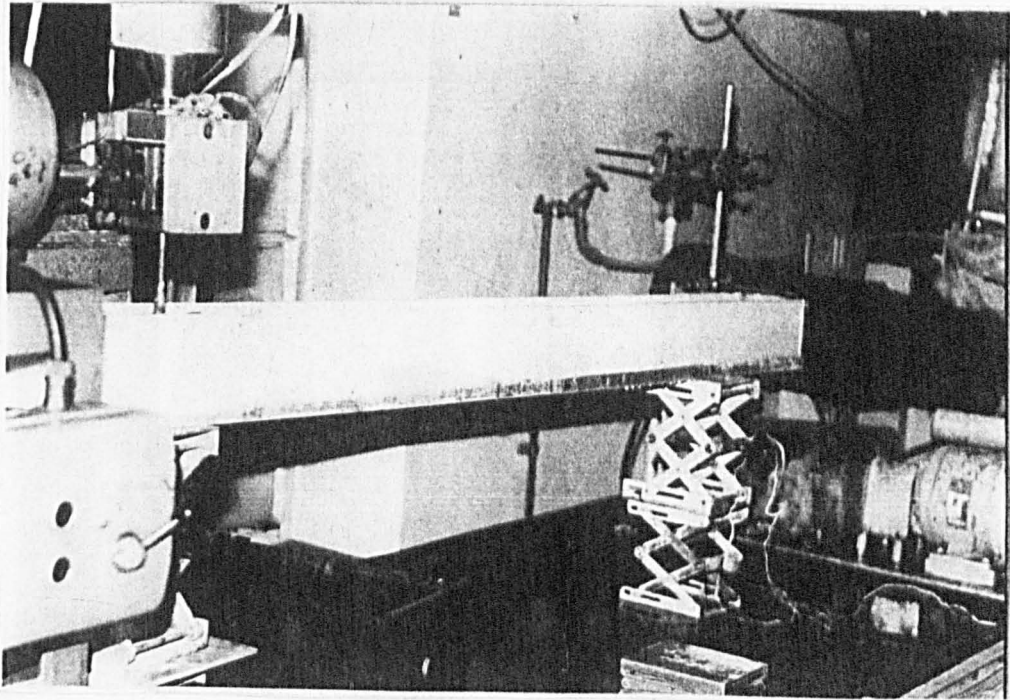

PLATE 2.6: The long coagulation bath (used mainly for wet spinning)

of a hook) and their direction changed towards the take-up roller. The depth of the roller in the bath could be easily varied by pushing the glass rod up or down. Through this means and the adjustable stand on which the bath was mounted, a constant filament depth of 7 ± 2 cm was maintained. The position of the lab-lock in the bath was kept constant so that by the aid of a guide placed between the bath and the take-up rollers, the effective length (30 cm) was maintained.

(ii) The long bath (Plate 2.6): This was about 120 cm long and was used in most cases for wet spinning, though in some cases it was used for dry-jet wet-spinning. In the case of wet spinning, the filaments were dragged horizontally through the bath by the take-up rollers. This was possible because the spinneret was mounted so that its face was vertical as against the horizontal position in the case of dry-jet wet-spinning. The length of the filaments in the bath was controlled by the position of the spinneret in the bath and the guide described above.

2.3.4 The stretching bath and advancing reels

This unit is shown in Plate 2.7 and consisted of the second roller of the first pair of advancing reels, a constant level hot water bath maintained at $80-85^{\circ}\text{C}$ and the second pair of advancing reels. At the beginning of this work, it was found to be extremely difficult to stretch the filaments without encountering frequent filament breakages. However, after various trials the following setting arrangements were found satisfactory and were used for all the drawing operations in air or hot water, unless otherwise stated. The two pairs of advancing reels were set at about 65 cm apart (measured from the second roller of the first pair to the first roller of the second pair of reels). The hot

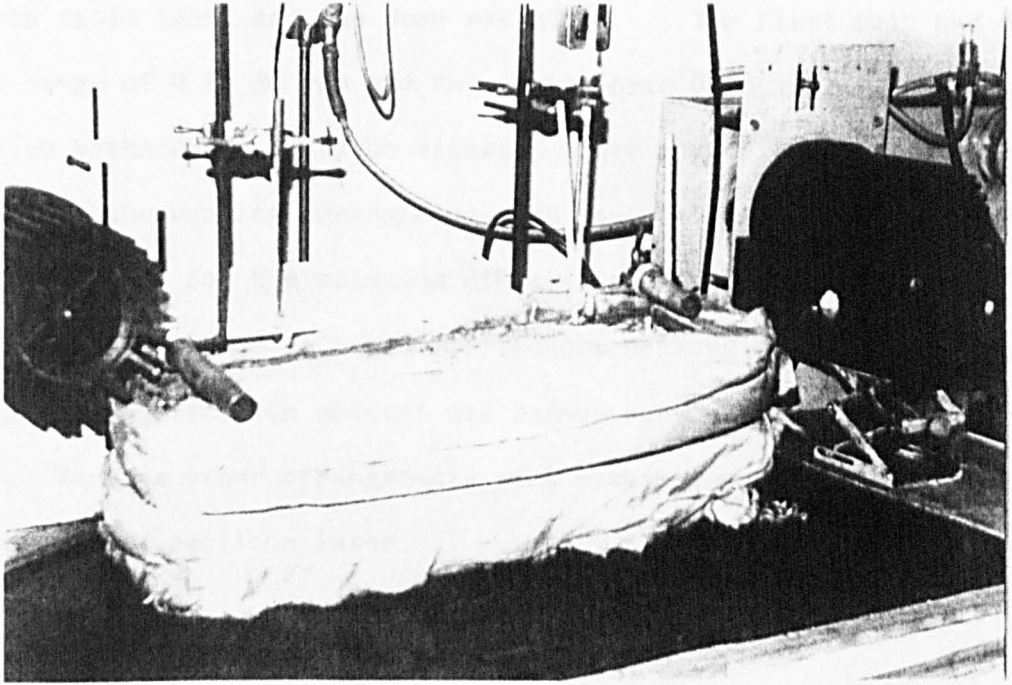

PLATE 2.7: The stretching bath and advancing reels

water bath was placed between the two pairs of advancing reels and set at about 35 ± 2 cm away from the first roller of the second pair of advancing reels. The bath was used in most cases for both hot drawing and washing. There were two glass rod guides immersed in the hot water bath, set at 20 ± 2 cm apart. The speeds of the two pairs of reels could be varied independently, making it possible to obtain the required jet stretch ratio (JSR) and the draw ratio (DR). The first pair had a speed range of 0 to 30 rpm and the second pair 0 to 90 rpm. There were two wash baths which could be situated under any of the advancing reels. Initially, the washing arrangement used was similar to that used by Nourpanah [113] for the spinning of acrylic fibres. However, this arrangement was found to be unsatisfactory because the fibres produced were still swollen with solvent and became very sticky on the drier rolls. Various other arrangements were examined and will be described in appropriate sections later.

2.3.5 The drying unit (Plate 2.8)

This unit was only used in the preliminary stages of the work, and was used for drying filaments which had been thoroughly washed in hot water alone or on some occasions in hot water and methanol in that order. The arrangement consisted of two positively driven chrome rollers, two idler rollers, and two radiant heaters. The speed of the chrome rollers could be varied by means of a rotary regulator. Normally, the surface speed of the rollers was adjusted so that slight relaxation of the filament took place between the draw rollers and the drying rollers. The temperature of the heaters could also be varied separately from room temperature to about 200°C .

2.3.5 Drying Unit (Plate 2.8)

In this system, the filament was mounted on a paper holder by means of a specially driven wheel which rotated from the motor. The holder was made to fit on a standard driven system and was held in place by the filament holder. It rested on the motor. The filament was driven by a set of gears and the speed

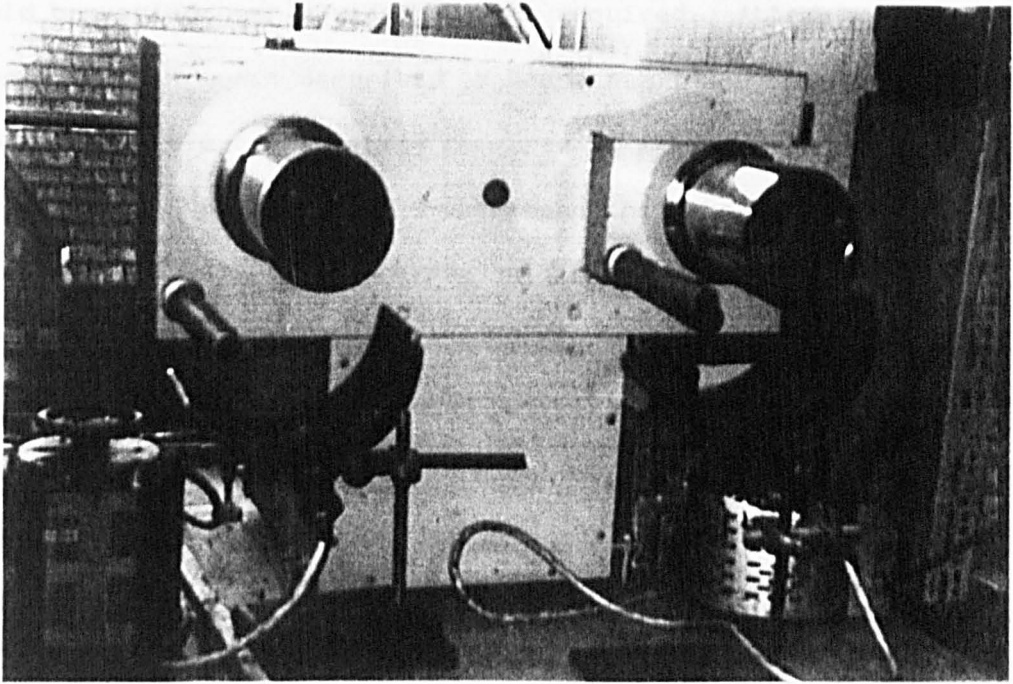

PLATE 2.8: The drying unit

2.3.6 Winding unit (Plate 2.9)

In this system, the filaments were wound onto a paper bobbin by means of a separately driven yarn guide which traversed from side to side. The bobbin was made to sit on a constant speed driven cylinder and was itself rotated by the frictional contact as it rested on the cylinder. The cylinder was driven by a set of gears and the speed could be varied over a wide range as required. Attempts to use the Leesona wind-up unit described by Nourpanah [113] were unsuccessful. Apart from the excessive time required to achieve a speed balance between the winder and the driers, it was found that the unit did not respond quickly and regularly to changes in fibre tension.

In many cases, due to slow coagulation and long washing times required, samples were not wound but were collected wet in hank form and stored in a wash bath, often in methanol. They were then dried either in an oven or vacuum oven or air.

2.4 Fibre production

2.4.1 Preparation of the spinning dope

Almost all the fibre spinning was done using chitin treated in TSA/IP as described earlier (section 2.2.10). Samples used differed in the time of this treatment between 30 minutes and 7 hours. The dopes prepared and used for spinning contained between 5 and 9% by weight of the treated chitin dissolved in DMA and 5-10% (w/w) LiCl. To obtain a homogenous dope, any of the following methods could be used:

(a) Z g of polymer was stirred with V ml of DMA for about 5 minutes, followed by gradual addition of X g of LiCl and continuous stirring for 24 h.

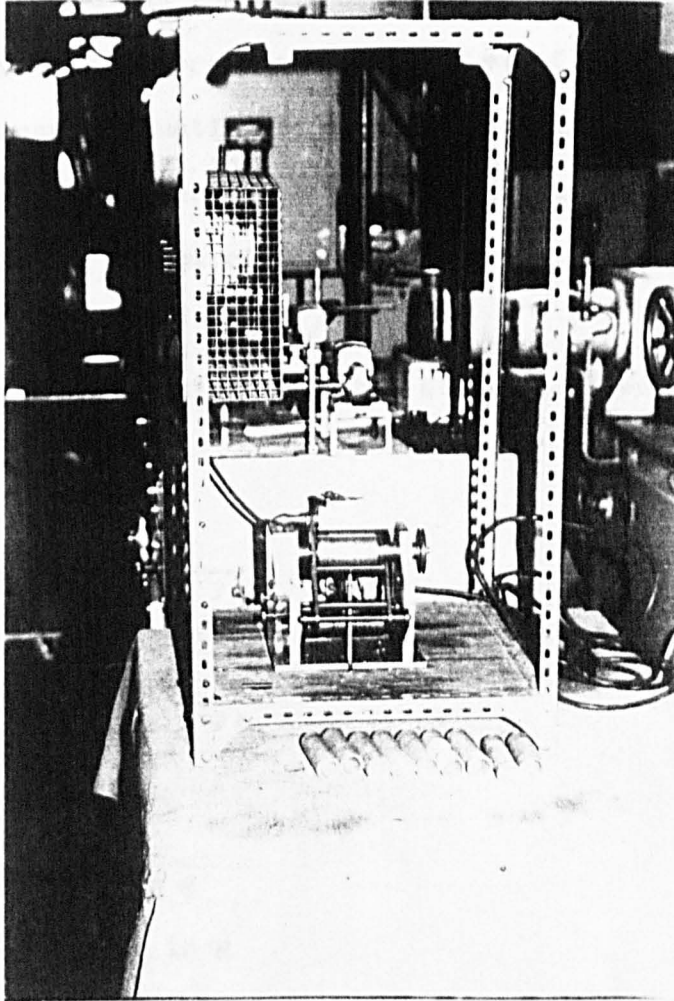

PLATE 2.9: Winding unit

(b) Z g of polymer and X g of LiCl were charged and manually mixed up well followed by addition of V ml of DMA. Stirring for 24 h gave the dope. This method was the main one used for making dopes.

(c) X g of LiCl were charged with V ml of DMA and the mixture stirred continuously until all the LiCl had dissolved. Then Z g of the polymer was added to the solution which was stirred continuously for 24 h. (Commonly, 500 ml of DMA was used with 38 g of chitin and 44 g LiCl.

The polymer weight and that of the LiCl were calculated as follows:

$$X = \frac{yV\rho}{100 - (w + y)} \quad (2.14)$$

$$Z = \frac{wV\rho}{100 - (w + y)} \quad (2.15)$$

where

X = weight of LiCl in g

Z = weight of chitin in g

y = % weight of LiCl

w = % weight of chitin

V = volume of DMA in ml

ρ = density of DMA (0.94 g/cc)

The dope (approximately 500 ml) was made up in a 2 litre plastic jar, and mechanically stirred with a stainless steel stirrer at 120 rpm. The solution was protected from atmospheric moisture as much as possible (to prevent possible coagulation at the surface) by covering the jar first with a polythene bag and then with the jar lid, allowing only the

shaft of the stirrer through. Typically stirring was carried out for 24 h.

2.4.2 Linear rate of extrusion

Assuming laminar flow the linear rate of extrusion is defined as:

$$V = \frac{4 \theta (10^4)^2}{\pi n d^2 100}$$

$$= \frac{4 \theta 10^6}{\pi n d^2} \quad (2.16)$$

where

V = linear rate of extrusion (m/min)

θ = volumetric flow rate (cm³/min)

n = number of holes in the spinneret, and

d = spinneret hole diameter (μm)

The pump which had a capacity of 1 cm³/rev was run at speeds between 3 and 6 rpm. The calculated linear rate of extrusion for most spinnerets used at various pump speeds up to approximately 6.6 rpm are shown in Table 2.3. The pump speed could be varied up to 26 rpm. The high pump capacity (1 cm³/rev) meant that spinnerets chosen were either those with large hole diameters and a small number of holes mainly suitable for dry-jet wet-spinning or small hole diameters (125-50 μm) with a fairly large number of holes (over 18) used only for wet spinning. The selection of spinnerets was thought necessary to avoid too low or too high linear extrusion rates which would lead to too high or too low take-up speeds. For satisfactory spinning, it was found that linear rates of extrusion

TABLE 2.3: Linear rate of extrusion for selected spinnerets
at various pump speeds for pump capacity $1 \text{ cm}^3/\text{rev}$

Pump setting	Pump speed (rpm)	Flow rate cm^3/min	Linear extrusion rate (m/min) for various spinneret hole sizes				
			400 μm 8 holes	300 μm 10 holes	150 μm 10 holes	125 μm 24 holes	80 μm 20 holes
1.3.8	3.00	3.00	2.98	4.24	16.98	10.19	29.84
1.3.5	3.12	3.12	3.10	4.41	17.66	10.59	31.04
1.3.0	3.29	3.29	3.27	4.65	18.62	11.17	32.73
1.2.5	3.45	3.45	3.43	4.88	19.52	11.71	34.32
1.2.0	3.65	3.65	3.63	5.16	20.65	12.39	36.30
1.1.5	3.88	3.88	3.86	5.49	21.96	13.17	38.60
1.1.0	3.98	3.98	3.96	5.63	22.52	13.51	39.59
1.0.5	4.32	4.32	4.30	6.11	24.45	14.67	42.97
1.0.0	4.59	4.59	4.57	6.49	25.97	15.58	45.66
0.9.5	4.83	4.83	4.80	6.83	27.33	16.40	48.04
0.9.0	5.04	5.04	5.01	7.13	28.52	17.11	50.13
0.8.5	5.33	5.33	5.30	7.54	30.16	18.10	53.02
0.8.0	5.67	5.67	5.64	8.02	32.09	19.25	56.40
0.7.5	5.94	5.94	5.91	8.40	33.61	20.17	59.09
0.7.0	6.19	6.19	6.16	8.76	35.03	21.02	61.57
0.6.5	6.58	6.58	6.55	9.31	37.24	22.34	65.45

Flow rate $\theta = \text{pump speed} \times \text{pump capacity}$
 $(\text{cm}^3/\text{min}) \quad (\text{rpm}) \quad (\text{cm}^3/\text{rev})$

of between 5 and 30 m/min were most suitable. Within this range, the first pair of reels were set at less than 30 m/min for stable spinning. Above this limit, the rate of breakage of the filaments increased and even if no breakage occurred it was difficult to thread the filaments through guides and rollers because of the high roller speeds. Generally, spinning at such high speeds lasted only for a short time. Below the rate of extrusion of 5 m/min, the first advancing reels were set at such low speeds that the rate of withdrawal of the filaments from the coagulation bath could not be maintained constant as the reels tended to slow down or even stop at some irregular periods.

In most cases, an extrusion rate of 17 m/min and first advancing reel speed of 10.2 m/min, using the 150 μm 10 hole spinneret; and an extrusion rate of 30 m/min and first advancing speed of 23 m/min, using the 80 μm 20 hole spinneret were used for wet spinning. In the case of dry-jet wet-spinning, an extrusion rate of 7.6 m/min and a first advancing reel speed of 21.7 m/min, using the 300 μm 10 hole spinneret were mostly used.

2.4.3 Maximum draw ratio

To determine the maximum draw ratios, the speed of the second advancing reels were set to draw the filaments by about 4%; thereafter the speed was increased in very small increments successively (by means of the variable speed regulator) until the filaments finally broke. When this occurred, the speed was gradually reduced until a more or less stable spinning was obtained. The speed at this point was taken and maximum draw ratio in percentage (x%) was calculated as follows:

$$x\% = 100(w_2 - w_1)/w_1 \quad (2.17)$$

where

w_2 = speed of the second advancing reels in m/min

w_1 = speed of the first advancing reels in m/min.

2.4.4 Spinning procedures

It was first necessary to ensure that the candle filter unit and some of the copper tubes through which the dope would pass were cleaned thoroughly to remove polymer dope left behind from the previous filtration operation. This necessitated dismantling of some of the pipe work and the fitting (in most cases) of a new candle filter. When this had been done, the dope was transferred to the candle filter reservoir and the lid clamped down. Pressure was applied above the dope from a nitrogen cylinder (15-20 lb/in²) and the gear pump switched on. It took about 10-15 minutes for the dope to emerge from the candle filter and when a continuous flow of almost bubble free dope was established, a plastic tube connecting the filter to the main spinning dope reservoir was screwed onto the end of the brass candle filter. After about 5 minutes, the dope emerged at the other end of the tube. When this had occurred, this end was then screwed onto the inlet on the main dope reservoir lid. The lid was only partially tightened down, as a complete seal would have caused a pressure build up in the tube. When most of the dope had been filtered into the reservoir, the tube was removed and the reservoir lid then completely tightened down. The plastic tube was then replaced by a nitrogen supply tube and the dope allowed to deaerate by standing for 5-7 days. When, however, high viscosity dopes (~60 Pas) were spun, they were subjected to a vacuum for about 1-2 h.

Deaeration could be monitored by the increase in pressure on the nitrogen pressure regulator which after observation was depressurized daily until the dope was spun.

Before spinning was commenced, the following routines were followed where appropriate:

- (a) The spinnerets were examined under a microscope and then cleaned in an ultrasonic bath when necessary.
- (b) Then the spinneret assembly containing the appropriate filtering device was prepared.
- (c) The dope and spinning block heaters were switched on to give the required temperature.
- (d) The hot water draw bath (when used) was cleaned properly, filled with fresh water and set to heat to 80-85°C. This took more than two hours, though the time could be reduced by using an additional heater.
- (e) If the filaments were required to be dried directly on the machine, the chrome rollers were preheated to about 80-150°C.
- (f) The take-up rollers (first pair of reels), draw rollers (second pair of reels) and the chrome rollers were all set up at their appropriate speeds using a tachometer.
- (g) If the filaments were required to be washed, then a wash bath was placed under the second roller of the first pair of advancing reels, and if required a second bath was placed under the first roller of the second pair. Where a hot water bath was used, the temperature was monitored frequently and when it cooled below a certain predetermined temperature, it was changed.

(h) The coagulant was prepared, poured into the required bath and, if necessary, heated to the desired temperature on a hot plate.

When the dope, draw bath and chrome rollers had reached the desired temperature, pressure was applied above the dope and the gear pump was switched on, to extrude at an extrusion rate higher than the desired rate, in order that air bubbles and dried polymer in the spinneret holder could be expelled. When bubble-free dope emerged from the spinneret holder, the gear pump was stopped and the spinneret assembly was screwed on. The coagulation bath was then mounted on one or two adjustable stands positioned either in the centre (for one stand) or at both ends of the bath. Again, the gear pump was set to extrude at a very high extrusion rate to quickly expel the air in the spinneret assembly.

When all the air had been satisfactorily expelled, the gear pump was reset to extrude at the required extrusion rate, and the stands adjusted so that the spinneret was completely immersed in the coagulant (for wet spinning) or with an air gap between the spinneret face and the surface of the coagulant (for dry-jet wet-spinning, Plate 2.10). In the case of dry-jet wet-spinning it was necessary to keep the surface of the spinneret dry in order to avoid 'false dry-jet wet-spinning' described by Patel [114] and to prevent the extruding solution from spreading over the spinneret face and causing a break down in spinning. In many attempts, wiping the jet with wiping fluids such as silicone oil was found to be very unsatisfactory. Rather satisfactory results were obtained by wiping quickly but firmly across the spinneret face with a dry soft paper towel.

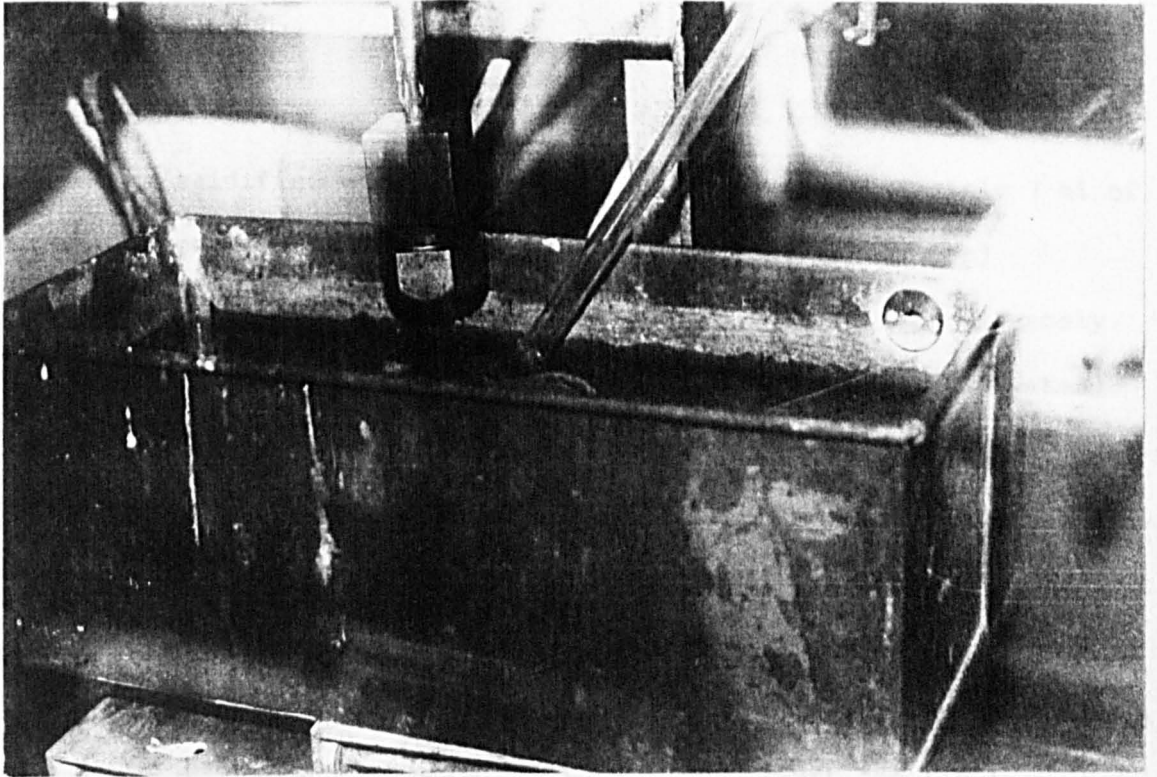

PLATE 2.10: Dry-jet wet-spinning

The fluid filaments were then allowed to pass through one of the following coagulants:

- (a) DMA/water of various composition, mostly 75:25.
- (b) Methanol
- (c) Butanol
- (d) Water
- (e) Water, acidified with acetic acid, pH = 3.4 (approximately 1 ml of 99.7% acetic acid diluted with 840 ml of distilled water)
- (f) Water made slightly alkaline with ammonia pH 10.6 (approximately 1 ml of ammonia solution diluted with 500 ml of distilled water)

After leaving the coagulation bath, the partially coagulated and heavily swollen filaments were guided with the aid of glass rods (in the shape of hooks) onto the first pair of advancing reels (take-up rollers). At this point, the filaments were weak and easily deformable, and the number of turns they were allowed to pass round the take-up rollers was very important since it determined to a large extent the final extensibility of the filaments. This fact was only noted part-way through the work. Because of various difficulties which will become clear, a wide variety of different yarn collection procedures were used which are detailed below.

- (a) After coagulation, the filaments were wrapped around the first roller of the first pair of advancing reels with twenty turns. Spinning was stopped and the filaments transferred to the second roller of the first pair of reels where they were washed in cold water or hot water and finally collected in hank form and dried either in air or in an oven at 75-80°C.

(b) For the case of filaments washed and dried in the machine, the filaments were passed around the first roller of the first pair of advancing reels with five turns and around the second with fifteen to twenty turns. They were washed on the second roller, passed into the hot drawing bath at 80-85°C and wound around the second advancing reels with fifteen turns around the first roller, for washing in methanol, and ten turns around the second roller. In this case drawing was almost impossible because of frequent filament breakages in the drawing bath; therefore, the speed of the pair of drawing rollers was set at (or about 12% more than) the speed of the take-up rollers. The filaments were then dried and wound on a paper cone. Many difficulties were encountered during the drying operation as filaments not only stuck together but also stuck to the rollers except where thorough washing in methanol was achieved.

(c) On occasions, filaments were passed around the first and second take-up rollers with fifteen turns each and washed in hot water (70°C) and methanol respectively. They were collected manually and dried in an oven at 75-80°C for 30 min.

(d) For drawn samples, filaments were passed around the first and second take-up rollers with one turn each but without washing. They were then passed through the hot drawing bath, from where they were led around the second pair of the advancing reels with one turn around the first and second rollers and finally into a waiting methanol bath. The filaments were allowed to stand for 2-5 hours and then dried as a hank in a vacuum oven at room temperature for 24 h.

(e) Samples of undrawn filaments were wound with no turns on the take-up rollers, allowed to accumulate slightly in the hot

drawing bath and then treated as for the drawn samples in (d).

2.5 Fibre characterisation

2.5.1 Determination of tensile properties

The tensile properties were measured using an Instron tester Model 1122 and a load cell (A-cell) type 2511-101 (capacity 0-500 g) at an extension rate of 10% per min. Measurements were made on single filaments mounted across 20 mm square holes cut in thin cards. Filaments with diameters less than 80 μm were mounted by means of Sellotape but for those with higher diameters it was found necessary to either

- a) reinforce the Sellotape with an adhesive such as 'Durofix', or
- b) use double sided Sellotape and cover with the usual one-sided Sellotape, or
- c) use the B-cell of lower sensitivity with manually tightened jaws to prevent filament slippage between the jaws of the testing machine.

Method (a) was used in most cases except where otherwise stated. In all cases filaments were mounted using minimum tensioning without damaging or stretching them.

Each 20 mm sample was taken from a separate length of filament. The samples were conditioned in a standard testing laboratory for 24 hours before testing ($20 \pm 2^\circ\text{C}$ and $65 \pm 2\%$ R.H.). For each batch, 15-20 load-elongation curves were obtained from which the following determinations were made:

$$\text{Tenacity (g/dtex)} = \frac{\text{mean maximum load at break(g)}}{\text{filament count (dtex)}} \quad (2.18)$$

$$\text{Filament decitex (dtex)} = \frac{\text{weight of filament (g)}}{\text{length (m)}} \times 10^4 \quad (2.19)$$

Extension at break (%) =

$$\frac{\text{mean extension (mm)} \times \text{crosshead speed (mm/min)} \times 100}{\text{chart speed (mm/min)} \times \text{sample size (20 mm)}} \quad (2.20)$$

Initial Young Modulus (I.Y.M.)

This is a measure of the force required to produce a small extension and is measured by the tangent of the angle between the initial part of the stress-strain curve.

$$\text{I.Y.M. (g/dtex)} = \frac{\text{filament tenacity (g/dtex) at } S(\text{mean})}{S} \quad (2.21)$$

where S = strain at a small extension (eg. at 2%).

Work of rupture (breaking toughness)

This was calculated from the area under the load-elongation curves and expressed in g.cm/dtex.cm.

$$\text{Work of rupture (g.cm/dtex.cm)} = \frac{A.S.R.}{G.W.L.T.} \quad (2.22)$$

where

A = area under the curve (cm²)

S = full scale load (g)

R = crosshead speed (cm/min)

G = effective specimen length (cm)

W = chart width (cm)

L = chart speed (cm/min)

T = filament count (dtex)

A was measured using a planimeter.

2.5.2 Fibre density determination

Fibre samples were prepared consisting of a small bundle of about 10 fibres tied together by a single fibre of the same lot, and then trimmed to about 5 mm in length. Two burettes were set up containing toluene and tetrachloroethylene respectively. The glass taps on the burettes were lubricated with glycerol. A known volume of tetrachloroethylene was run into a clean glass stoppered test tube and a fibre bundle inserted. Air bubbles were removed by pressing the bundle of fibres against the side of the tube with a glass rod. Aliquots of toluene (1 ml) were added from the second burette. The tube was stoppered between each addition, swirled gently to mix the liquids and the position of the bundle in the mixture observed when the bundle came to rest. Aliquots were added until the bundle showed no definite tendency to float or sink. The density of the liquid mixture at this point is equal to the fibre density and is given by

$$\rho_F = \rho_m = \frac{\rho_1 V_1 + \rho_2 V_2}{V_1 + V_2} \quad (2.23)$$

where

ρ_F = density of the fibre

ρ_m = density of the liquid mixture

ρ_1 = density of tetrachloroethylene (1.62 g/cc)

ρ_2 = density of toluene (0.87 g/cc)

V_1 = volume of tetrachloroethylene (ml)

V_2 = volume of toluene used (ml)

2.5.3 Fibre diameter

Fibre diameter was measured using a simple laboratory microscope (Vickers Instruments M 14/2) or, in some cases, a Projectina Microscope; 15-20 measurements were made on each sample by arranging the filaments on a microscopic slide and measuring their diameters in turn. Variations along the length of the filaments and between filaments were also checked, after which the mean, standard deviation (SD) and coefficient of variation (CV) were calculated. Where the variations were not considered significant, only the mean was reported. It was found that variations along the filaments were not common, but there were some variations usually less than 10% between filaments from the same batch.

2.5.4 Linear density

In wet spinning, the theoretical linear density of the filament yarns produced depends on dope concentration, the volumetric flow rate (ie. rate of supply of dope to spinneret hole per minute) and the final wind-up speed. Generally, this can be calculated using the formulae shown below:

$$\text{Yarn count (in dtex)} = \frac{100 \text{ C.V.R. } \rho_D}{W} \quad (2.24)$$

$$\text{dtex/filament} = \frac{100 \text{ C.V.R. } \rho_D}{W.n} \quad (2.25)$$

where

C = dope concentration in percentage

V = pump capacity in cc/rev (=1)

R = pump speed in rpm

ρ_D = the density of the polymer dope in g/cm^3 (= 1.086 determined at room temperature using specific gravity bottle)

W = final wind-up speed m/min, and

n = No. of holes in the spinneret.

When the measurement of fibre weight was considered difficult because of too small a fibre sample, the densities of the sample were determined as described in section 2.5.2; then the linear density (count of a single filament) was determined according to the formula:

$$\text{filament count (dtex)} = \frac{\pi d^2 \rho_F}{400} \quad (2.26)$$

where d = fibre diameter in μm

ρ_F = fibre density in g/cm^3

However, when samples were large enough, actual measurements were made using a cutting and weighing method; a length of sample (1 m) was measured and weighed accurately on a five figure balance. The fibre decitex was calculated according to equation (2.19). About 10 of such measurements per sample was made and their mean value determined. Samples were conditioned in standard atmosphere for 24 hours before testing.

The theoretical fibre diameter was calculated using equation (2.27).

$$\text{fibre diameter } (\mu\text{m}) = \left(\frac{4 \times 10^4 \text{ C.V.R. } \rho_D}{\rho_F \pi W n} \right)^{\frac{1}{2}} \quad (2.27)$$

2.5.5 Surface characteristics

Examination of filament surfaces were carried out using a scanning electron microscope ('Stereoscan', Cambridge Instruments Ltd.) in the department. For some samples light microscopic examination of the fibre cross-sections was carried out as follows: A steel plate (74 mm x 28 mm) and less than 1 mm thick containing 4 holes of approximately 1 mm each was used. Both ends of a piece of monofilament wire were threaded through one of the holes to form a loop, through which a number of chitin filaments were pulled through by means of the wire, the number of filaments threaded through being such that they firmly filled the hole. When the filaments had been positioned very well in the hole, the projecting tips of the filaments were cut from both sides of the plate with a new sharp razor-blade by single strokes.

Then the section was observed directly under a hot stage microscope for any possible birefringence using polarised light. Sketches of some of the cross-sections were made or photographed where necessary.

2.5.6 X-ray diffraction pattern

Wide angle X-ray diffraction photographs, calibrated using silver foil, were taken using a Hilger and Watts Y 90 constant output generator, with a water cooled copper target in a sealed tube. Based on the calibration, attempts were made to determine the unit cell of the chitin fibre from the diffraction patterns.

2.5.7 Moisture content and thermal analysis

The moisture content, thermal stability and decomposition of the fibres were determined using TGA as described earlier (section 2.2.7),

except that 1.8-3 mg of samples were used. However, some difficulties were encountered initially when it was suspected that the quartz was also losing weight together with the fibre after about 230°C, due perhaps to attack by traces of LiCl left in the fibre. But later trials were found to be satisfactory. The moisture content was determined from the curves obtained since drying took place between 50-80°C where the weight loss was considered to be due entirely to the moisture in the fibre.

To confirm the results obtained from TGA, a sample of chitin fibre was conditioned for 24 h at standard testing atmosphere, weighed, dried for 24 h at 80°C and reweighed.

$$\text{Moisture content (\%)} = \frac{m_1 - m_2}{m_2} \times 100 \quad (2.28)$$

where m_1 = mass of undried fibre

m_2 = mass of dried fibre

(Preliminary drying experiments showed that constant weight could be obtained in about 24 hours at 80°C.)

CHAPTER 3

PRELIMINARY STUDIES OF THE SPINNING OF CHITIN FIBRES

3.1 Initial comments

The chitin samples used were first treated as described in section 2.2.10 and the spinning solutions then prepared as described in section 2.4.1. Attempts were also made to prepare spinnable solutions from untreated chitin samples (C1, C2 and C3). In this respect, solutions containing 0.5-3.5% by weight of chitin in 5-8 wt % DMA-LiCl were prepared by stirring at room temperature overnight using initially a 120 rpm stirrer, then a variable speed stirrer at 3,000 rpm for 30 min.

The fibres were prepared by wet spinning and dry-jet wet-spinning using the laboratory wet spinning equipment already described in section 2.3. The coagulation bath was of the short type (30 cm in length) and was used throughout the initial spinning trials except where otherwise indicated.

3.2 Results and discussion

Initially attempts were made to reproduce the main features of the work reported by Rutherford and Austin [57] using untreated chitin (C1, C2 and C3). However, several difficulties were encountered. Solutions containing 3% (w/w) or more chitin were jelly-like and would not flow properly. Furthermore, the solutions could not be filtered or degassed properly. Those solutions containing less than 1% chitin could be easily filtered and degassed; however, such solutions gave discontinuous thread lines from the spinneret. It became apparent then that there was a relatively narrow range of concentration over which suitable dope might be prepared. Even then, the solutions contained lumps and undissolved flakes always, which made filtration even more difficult. Although not much success was achieved with the filtration and none at

all with spinning because of filter blockage, it was believed that with time the solutions could be filtered to give more spinnable dopes. In any case, it was not considered necessary to spend too much time on this, considering the low value of the solids content practicable. Instead, the need to obtain solutions which could be easily degassed, filtered, with a higher solids content and yet maintaining a relatively stable composition was more important. If this could be achieved a more viable spinning process could be developed.

The following approaches were then considered:

- (a) change solvent;
- (b) depolymerise chitin;
- (c) pretreat chitin to remove possible impurities.

Option (a) was considered a possibility in the early stages of the work and the results of a preliminary examination of alternative solvents are given in section 4.1. Although there were quite a number of other effective solvents for chitin, none was claimed to provide as stable a solution as the amide-LiCl system. Mixtures of dichloroacetic or trichloroacetic acid with other organic solvents (eg. methylene chloride and chloral hydrate) reported as useful by Austin and Brine [92] were tried and rejected because the rate of degradation was too rapid, (see appendix 1).

Option (b) was found to be much more promising. It was found that the treatment with *p*-toluene sulphonic acid in isopropanol (PTS/IP) not only depolymerised the chitins to lower values of $[\eta]$ between 3.6 and 5.0 dl g^{-1} but produced chitins whose solutions in DMA-LiCl system were clearly homogeneous. At the same time as this improvement in solubility was noted, a paper on solutions of cellulose in DMA-LiCl was

published, indicating that LiCl contents as high as 10% could be used [115]. The use of LiCl above the level of 5% and the PTS/IP treatment made it possible for solids contents up to 10% by weight to be prepared and for processes such as degassing and filtration to be relatively easy, depending on the polymer concentration.

The third option was explored by a further purification treatment with sodium hydroxide (1 N) for 24 hours at room temperature. This gave flakes which were very white though the flakes were still not totally soluble in DMA/LiCl.

It was now clear that option (b) should form the basis of further spinning trials. In attempting to prepare fibres from depolymerised chitin solutions, however, several difficulties remained. No published work on spinning chitin from amide-LiCl systems was available when this study was started. Even today the only work published is that by Nakajima et al [96] in 1984 and no details of the spinning process are given. It was decided, therefore, to carry out a preliminary comparison of both wet-spinning and dry-jet wet-spinning using different spinnerets and coagulants under various conditions to establish the range of conditions under which spinning was possible. In this respect, wet-spinning was carried out using spinnerets with 80-150 μm hole size and dry-jet wet-spinning was performed with spinnerets typical of that method of spinning, that is, 150-400 μm . The coagulation bath was varied from DMA/water to water alone and to dilute acidic and alkaline conditions and finally alcohols. After several trials with the spinneret face mounted horizontally downwards with no success, a slight adjustment whereby the spinneret face was positioned vertically and the filaments pulled from it horizontally onto the first advancing reels was found

satisfactory. Therefore while the former method was reserved for DJWS, the latter was used for wet spinning (Figs. 3.1 and 3.2).

3.2.1 Effect of ageing on dope

At first attempts to spin solutions within the first 24 h after they were prepared failed. The reason for this was not known, but might have been associated with either insufficient degassing or the low viscosity of the dopes or both. Surprisingly though, such dopes were always spinnable after ageing for at least four days, provided the solution viscosity at the spinning temperature was not too low (>3 Pas). Table 3.1 shows the mechanical properties and viscosity changes obtained with the ageing of one dope. The ageing time zero was arbitrarily taken after stirring the dope overnight, (18 h). The filaments after coagulation were passed round the first roller of the first pair of advancing reels with 20 turns. When these turns were wound, spinning was stopped and the filaments transferred to the second roller of the first pair of advancing reels where they were washed in cold water. It was not possible to dry the filaments effectively with the dryers on the machine because the filaments were very swollen and sticky even after washing in cold water for 5 minutes. Therefore, after the initial washing with water on the machine, the filaments were collected in hank form and immersed in a methanol bath for 15 minutes. The hanks were carefully hung without tension between any two sides of an open square frame and then kept for 1 hour in an oven at $70-75^{\circ}\text{C}$ to dry. After drying, it was observed that the filaments had become very taut on the frame.

Although the results obtained were slightly inconsistent, it appears that under the conditions examined, the dope viscosity increased

FIG. 3.1: Spinneret mounted with its face horizontal for dry-jet wet-spinning

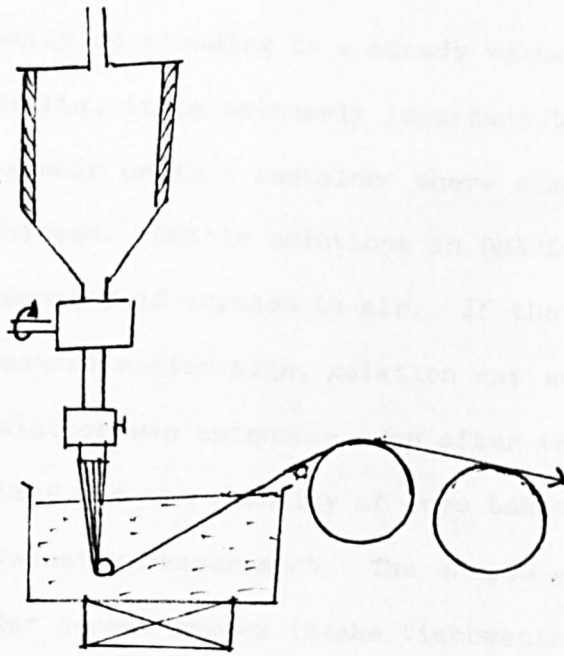
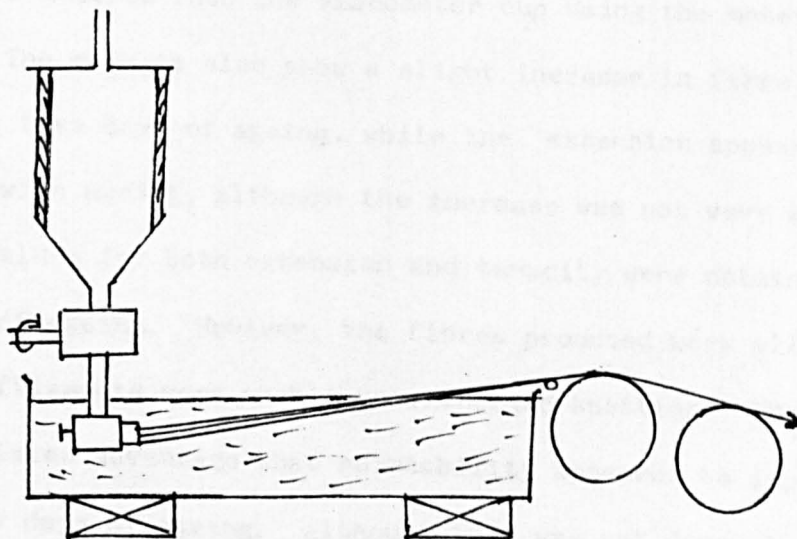

FIG. 3.2: Spinneret mounted with its face vertical for wet spinning



gradually on standing to a steady value after one week. For reliability of results, it is extremely important that the solution be stored in a reservoir or in a container where complete sealing from moist air can be achieved. Chitin solutions in DMA/LiCl absorb moisture and increase in viscosity if exposed to air. If the time of exposure is long and dope concentration high, gelation may even result. When sealed properly, the solution was spinnable even after three months of storage. Also important was the quantity of dope taken each time in the viscometer cup for viscosity measurement. The sample volume recommended for the SVI cylinder sensor system (Haake Viscometer) is 12 ml. It was difficult to measure this volume exactly each time because of the high viscosity of the dope. However, while volumes slightly in excess of 12 ml did not affect the results, lesser volumes gave considerable variations. Since the dope was stored in the spinning dope reservoir, the correct volume was always metered into the viscometer cup using the metering pump.

The results also show a slight increase in fibre tenacity after the first five days of ageing, while the extension appeared to increase with ageing, although the increase was not very substantial. Maximum values for both extension and tenacity were obtained between 5-9 days of ageing. However, the fibres produced were all very brittle in that the filaments were unable to withstand knotting. There was also the associated advantage that spinnability appeared to improve after at least 4 days of ageing. Although this was not directly measured, spinnability as used in the present context refers to the ease of producing fibres without frequent breakage as the fibres were pulled away by the first pair of the advancing reels. A rough guide of assessing the spinnability of the dope was to measure the standard deviation of

TABLE 3.1: Effect of ageing on dope viscosity and fibre properties (fibres dried in an oven under tension)

Sample No.	Time (day)	Viscosity 25°C, 7.1 sec ⁻¹ (Pas)	Tenacity (T)		Extensibility (E)		TE ^{1/2}
			(g/dtex)	SD	(%)	SD	
3-1	2	19.2	0.88	2.31	20.0	3.20	3.94
3-2	3	19.2	0.87	2.31	19.0	4.15	3.79
3-3	5	21.0	0.95	1.96	23.0	4.24	4.56
3-4	7	21.9	1.00	1.70	23.5	3.40	4.85
3-5	9	21.8	0.98	1.60	24.4	3.30	4.80
3-6	11	22.0	0.93	1.87	27.0	2.88	4.83
3-7	14	22.1	0.90	1.17	23.4	2.50	4.35

Spinning conditions: (3-1 to 3-7)

Dope concentration 6.9%(w/w), LiCl 6.9% (w/w)

Coagulation bath composition: 100% water

Average fibre count: 35.0 dtex

Spinneret: 150 µm, 18 hole

Jet stretch ratio: 0.6

Chitin: C3-2

Linear extrusion rate: 9.4 m/min

First advancing reel speed: 5.6 m/min

Pump speed: 3 rpm

Fibres dried in an oven at 70-75°C

the breaking loads and extensions obtained from load-elongation curves of 15 samples. As observed from the table, the values appear to be decreasing with ageing. Another advantage obtained from ageing was more complete degassing. It was observed that within the ageing period of about one week, complete degassing of the dopes was achieved. It became the only means of degassing high viscosity dopes (above 60 Pas) after they were given an initial vacuum treatment for 2 hours.

These changes observed in dope viscosity and fibre properties were thought to be connected with some form of structural rearrangement made possible by the dissolution process. Such structural rearrangement could also be responsible for the changes in optical activities with time reported by Rutherford and Austin [57,95] or changes in ultraviolet absorption of microcrystalline chitins reported by Castle et al [116]. A similar effect was observed too when McCormick and Shen [115] dissolved cellulose in DMA-LiCl. They reported that the apparent viscosity of a 1% solution of cellulose in DMA-LiCl increased initially but was followed soon by a decrease up to 48 hours, after which a steady value was reached. They attributed the effects to changes in inter- and intramolecular hydrogen bonds.

In another set of experiments to investigate the effect of dope ageing on fibre properties, the filaments after passing around the first roller of the take-up reels with five turns and the second with fifteen turns were drawn by 12% in a hot water bath at 80-85°C. This was about the maximum draw ratio the filaments could withstand. Before drawing, they were washed in warm water on the second roller of the first pair of advancing reels and with hot water after drawing on the first roller of the second pair of advancing reels (drawing rollers).

The surface speed of the drying rollers was set at 4-5% more than that of the second pair of drawing rollers for each sample, so that the filaments were pulled under slight tension. The winder surface speed was adjusted to equal that of the drying rollers. Lower winder speeds caused filament slackness and entanglement around the drying rollers resulting in breakages. At a higher winder speed, the filaments immediately snapped.

The results obtained are shown in Table 3.2. The testing was carried out in standard conditions and in cold wet conditions in water. For testing in wet conditions, the fibres were immersed in a special tank of water (3.0 litres) mounted on the Instron tester at room temperature for 3 minutes and then extended while remaining in the water. The results show that while tenacity went up by about 50% of the previously obtained results, the extensibility went down by a factor of about 3. This resulted in extremely brittle fibre. The wet strength shows a fall by a factor of about 3, while the extensibility increased by about 3% over the dry results. It was also found that drawing was very difficult to do as the fibres broke frequently in the hot water bath. The fibres were still very difficult to dry completely on the rollers in spite of washing thoroughly in hot water and drawing. Whilst dope ageing again gave an increase in viscosity amounting to 10% of the first measurement, by day 8, the changes in fibre properties were quite small.

Considering the lack of success in spinning fibres from the untreated chitin samples, it was very encouraging to observe that fibres could be easily made from the treated samples. Now that it has been shown that fibres with properties comparable with those produced by other workers (see section 1.9) can be easily made, attention was

TABLE 3.2: Effect of dope ageing on properties of drawn fibres
(fibres dried on the chrome roller)

Sample No.	Time (day)	Tenacity		Extensibility		Tensile factor	Viscosity 25°C, 7.1 sec ⁻¹ (Pas)
		g/dtex	SD	(%)	SD		
3-8	2	Dry	1.28	3.40	6.9	2.18	9.0
		Wet	0.30	1.09	8.2	1.13	
3-9	4	Dry	1.33	2.75	8.2	1.36	8.7
		Wet	0.35	1.56	10.0	1.88	
3-10	6	Dry	1.42	2.15	8.5	1.31	9.6
		Wet	0.38	2.32	12.5	1.44	
3-11	8	Dry	1.39	1.89	8.8	1.60	10.4
		Wet	0.34	3.05	12.8	2.45	
3-12	10	Dry	1.40	2.42	9.0	1.06	10.0
		Wet	0.36	1.77	12.5	2.38	

Spinning conditions (3-8 to 3-12)

Dope concentration 6% (w/w) chitin, 9% (w/w) LiCl

Coagulation bath composition: 50% DMA

Average fibre count: 28 dtex

Jet stretch ratio: 0.50

Chitin: C1-6

First advancing reel speed: 8.5 m/min

Second advancing reel speed: 9.5 m/min

Drying roller speed: 10.0 m/min, temperature 140°C (estimated)

Spinneret: 150 µm, 10 holes

Pump speed: 3 rpm

Draw ratio: 12%

directed towards improving these properties. Based on these results, it was also decided to store the dopes for at least five days before spinning.

3.2.2 Studies on the effect of coagulation variables on fibre properties

There are a large number of nonsolvents which could be used as coagulation media for the DMA-LiCl-chitin system. This presented a lot of problems initially as it was difficult to decide on what to use, and to add to the difficulties, no published work existed on the coagulation behaviour during the wet spinning of chitin. Nevertheless, decisions were made based on other well established wet spinning processes such as acrylic spinning. In such processes the rate of coagulation is a function of bath composition [117,118] and such baths contained part of the solvent used in dissolving the polymer [117-120]. In such cases, it has been observed that an increase in the solvent content in the bath reduced the driving force for diffusion and consequently the fluxes of solvent (outwards) and nonsolvent (inwards) were retarded. The effect of this may not always lead to any substantial improvement in fibre properties as was observed by Nourpanah [113] and Knudsen [117], although the former obtained an increase in extensibility with increasing DMF content in the bath. However, it appeared that such a lack of effect was observed mostly on fully drawn fibres; as some significant changes were reported in the properties of undrawn fibres with increasing DMA content in the bath [117].

While the effect of dope temperature is not generally considered as an important variable for altering the mechanical properties of wet spun fibres, increasing the dope temperature is often done to reduce

dope viscosity. The effect of dope concentration has been reported by several authors to be significant [113,117,121]. In most cases a consistent improvement in tenacity is usually observed with increasing dope concentration. However, it has not much effect on fibre extensibility or modulus [113,117]. Another variable associated with the coagulation process is the coagulation bath temperature, and a rather general conclusion is that decrease in bath temperature leads to slower coagulation and consequently improved fibre structure. This leads to a reduction in voids and improvement in some of the physical and mechanical properties such as lustre, density, internal surface, tenacity, abrasion resistance and initial modulus [113,117,119,120]. However, it is not clear why fibre properties increase with decrease in bath temperature. Knudsen [117] suggested that the improvement is due to a slower rate of coagulation. As the coagulation rate is retarded, more time is available for internal adjustment of osmotic stresses, resulting in denser fibres. Besides, less skin is formed and this in turn may lead to fewer large voids. He further suggested that a reduced bath temperature changes not only the rate, but also the character of the coagulation, indicating that although an increase in the solvent component in the bath leads to a similar slow rate of coagulation, fibre properties are not readily improved with increasing solvent in the bath. At high bath temperatures, it was suggested that the exchange between solvent and nonsolvent takes place at almost equal rates, while at low temperatures, the outward diffusion of solvent predominates, resulting in nonround sections and higher fibre density.

As indicated earlier, the first fibres spun from chitin were swollen and difficult to dry without the fibres sticking together. Also

observation of the cross-section of the fibres using a microscope indicated round and voidless cross-sections. It was thought that the rate of coagulation might have been too slow, and a search was then commenced to investigate all the coagulation variables starting from bath composition, dope temperature and concentration to see if conditions could be found in which the fibres readily deswelled in the bath. At the same time it became necessary to consider suitable fibre washing procedures which would further deswell the fibres and create a better opportunity for continuous drying on the chrome rollers. In view of the difficulties encountered during the first attempts to draw the fibres, further drawing attempts were suspended at this stage (except where otherwise indicated) until a better understanding of the spinning process has been gained.

3.2.2.1 Effect of bath composition

In the first attempt, baths containing between 0-83% by volume of DMA in DMA-water compositions were used. Fibres were produced from the same dope by wet spinning under the same spinning conditions except for changes in bath composition. The dope was spun after storing for five days. In each case, filaments were first collected on the first roller of the pair of take-up rollers with 20 turns. Spinning was stopped after the coagulation bath had been lowered to expose the spinneret. The filaments produced were then transferred to the second roller of the same pair of rollers and washed in cold water for 3 minutes. After this, the samples were collected in hank form and hung in the air for four days to dry. During the drying period, it was observed that the filaments contracted enormously. They stuck together, had a discolored appearance and separation into single filaments was

completely impossible without stretching and breaking them. The filaments were therefore given a good wash, first in boiling water for 15 minutes, then in acetone for 5 minutes and finally hung in air to dry after a further wash in acetone. The filaments now became easily separated after these washings and drying. The dirty appearance decreased and was completely absent in fibres spun from high DMA baths (75-83%). These latter fibres were highly lustrous, the lustre decreasing with decrease of DMA in the bath. Fibres from the 100% water bath were very dull. It was found that spinning became more difficult as the DMA increased in the bath and impossible above 83%.

The diameters of the filaments were measured using the Projectina microscope and it was observed that the diameters varied between and within filaments. Fibres spun from 100% water bath and baths containing over 75% DMA showed more variability. Fibre surfaces were also marked by thick and thin features and peculiar depressions but this decreased with increasing DMA in the bath.

Fibre properties obtained are shown in Table 3.3. From the results, it is clear that very little change occurred in the strength of the fibres as the bath changed from 100% water to 50:50 DMA/water. However, under the conditions examined, the 75-83% DMA baths gave the highest values of tenacity but the lowest values for extension. There was a gradual fall in extension as the proportion of DMA increased in the bath. The wet strength of the fibres reduced by more than a half while extension increased especially for fibres spun into baths containing less than 50% DMA.

It was initially believed that the results obtained were affected by the drying procedure. It was realised that the filaments

TABLE 3.3: Effect of coagulation bath composition on mechanical properties (dried in air under tension)

Sample No.	Bath composition DMA/H ₂ O, v/v	Diameter		Fibre count dtex	Tenacity (T) g/dtex	Extensibility (E) (%)	Tensile factor TE ^{1/2}
		μm	SD				
3-13	0/100	52.0	10.06	29.5	0.80 (0.36)	31.4 (50.0)	4.48 (2.54)
3-14	25/75	46.0	8.50	23.0	0.83 (0.37)	27.5 (52.0)	4.35 (2.67)
3-15	50/50	46.0	8.23	22.3	0.81 (0.29)	25.0 (45.0)	4.05 (1.95)
3-16	75/25	42.0	9.00	20.0	1.15 (0.34)	16.9 (26.0)	4.73 (1.73)

() wet tenacity and extension

Spinning conditions (3-13 to 3-16)

Chitin: C1-6

Dope concentration: 6% (w/w), 9% (w/w) LiCl

Spinneret: 150 μm, 10 hole

Jet stretch ratio: 0.75

were highly swollen even after washing in water and drying them in air by hanging might have resulted in some kind of structural collapse as indicated by the more variable cross-sections observed in the high DMA bath samples.

It was therefore decided to repeat the experiment but under different conditions. The details of the changes made are shown in the spinning conditions below Table 3.4. Similar bath compositions were used. (Since fibres washed in water and hung in air to dry stuck together, it was decided to use the washing and drying methods previously employed for preparing samples 3-1 to 3-7.) The filaments were wound with the same number of turns as previously, and after the initial cold water wash on the roller, were manually collected in hank form and kept in methanol for 15 minutes. They were then carefully hung without tension between two opposite sides of an open square frame and kept in an oven at 70-75°C for 30 minutes to dry. This method of drying as earlier indicated (section 3.2.1) resulted in tautness of the filaments on the frame during drying. The results obtained are shown in Table 3.4. These results again indicated that tenacity increased and elongation decreased with increasing DMA content in the bath in a similar pattern to the earlier run. The increase in tenacity was, however, small when compared with the loss in extensibility. The tensile factor, on the other hand, was hardly affected, although the values indicated a progressive decrease with increase in DMA in the bath. At high DMA content, the fibres were more brittle. This was associated with the low values of extensibility obtained for these samples. Again, it was observed that fibres produced from baths containing less than a certain amount of DMA in the bath were dull. In this case, those produced from baths containing over 50% DMA

TABLE 3.4: Effect of coagulation bath composition on mechanical properties
(fibres dried in an oven under tension)

Sample No.	Bath composition	Diameter WS μm	Fibre count WS dtex	Tenacity, T (g/dtex)		Extensibility, E (%)		Tensile factor TE ^{1/2}	
				WS	DJWS	WS	DJWS	WS	DJWS
				DMA/H ₂ O, v/v					
3-17	0/100	55.0	32.0	1.10	1.12	28.0	25.3	5.82	5.63
3-18	25/75	54.3	32.0	1.11	1.21	26.0	18.8	5.66	5.24
3-19	50/50	52.7	31.0	1.16	1.24	24.3	19.0	5.72	5.40
3-20	75/25	50.0	28.0	1.21		18.9		5.26	
3-21	83/17	50.0	28.0	1.22		11.7		4.17	
3-22	Water/5% LiCl	55.0	33.0	0.75		28.40		4.00	
3-23	DMA/10% LiCl /33% water	51.5	29.0	0.96		21.40		4.40	
3-24	DMA/10% LiCl /80% water	53.7	31.5	0.87		27.0		4.50	

Spinning conditions (3-17 to 3-24)

Average fibre count DJWS: 33 dtex

Average fibre diameter DJWS 55 μm; Air gap 1.5 cm

Jet stretch ratio: a) DJWS 1.30 (300 μm, 10 holes)

b) WS 0.6 (150 μm, 10 holes)

Polymer dope concentration: 7%(w/w), LiCl 8% (w/w)

Chitin: C3-2

were lustrous and the fibre lustre appeared to increase with increasing DMA in the bath. It was also observed that spinnability decreased with increasing DMA in the bath. Above 83% DMA, it was not possible to spin as the fibres became extremely sticky and weak, presumably as a result of too slow a coagulation rate.

The reasons for the fibre properties obtained were not very clear, but may have been connected with the weak state of the partially coagulated and easily deformable filaments obtained. Handling the fibres to wrap them on to the rollers was much easier when spinning into 100% water as these filaments at this stage were far stronger than those spun into high DMA baths. Because the initial filaments were weaker when extruded into the high DMA baths, they would presumably be more susceptible to deformation. If filaments spun into high DMA baths were more easily stretched, this should result in smaller filament diameters. To assess this possibility, fibre diameters were measured and found to decrease with increasing DMA in the bath. Observation of the fibre surfaces through the microscope also indicated the peculiar surface characteristics observed earlier, consisting of the occurrence of what appeared to be droplets or depressions over the entire fibre surface. To investigate this further, electron micrographs of the surfaces were obtained on the scanning microscope (Plates 3.1(A) and 3.1(B)). The most noticeable difference between the plates was that the surface features appeared to have greatly reduced in high DMA baths due, it was thought, to the stretching effect mentioned above. Furthermore, the Plates also show the difference in fibre diameters. Fibres produced from baths with little or no DMA content always gave a higher fibre diameter. The cross-sections of the fibres were also observed and

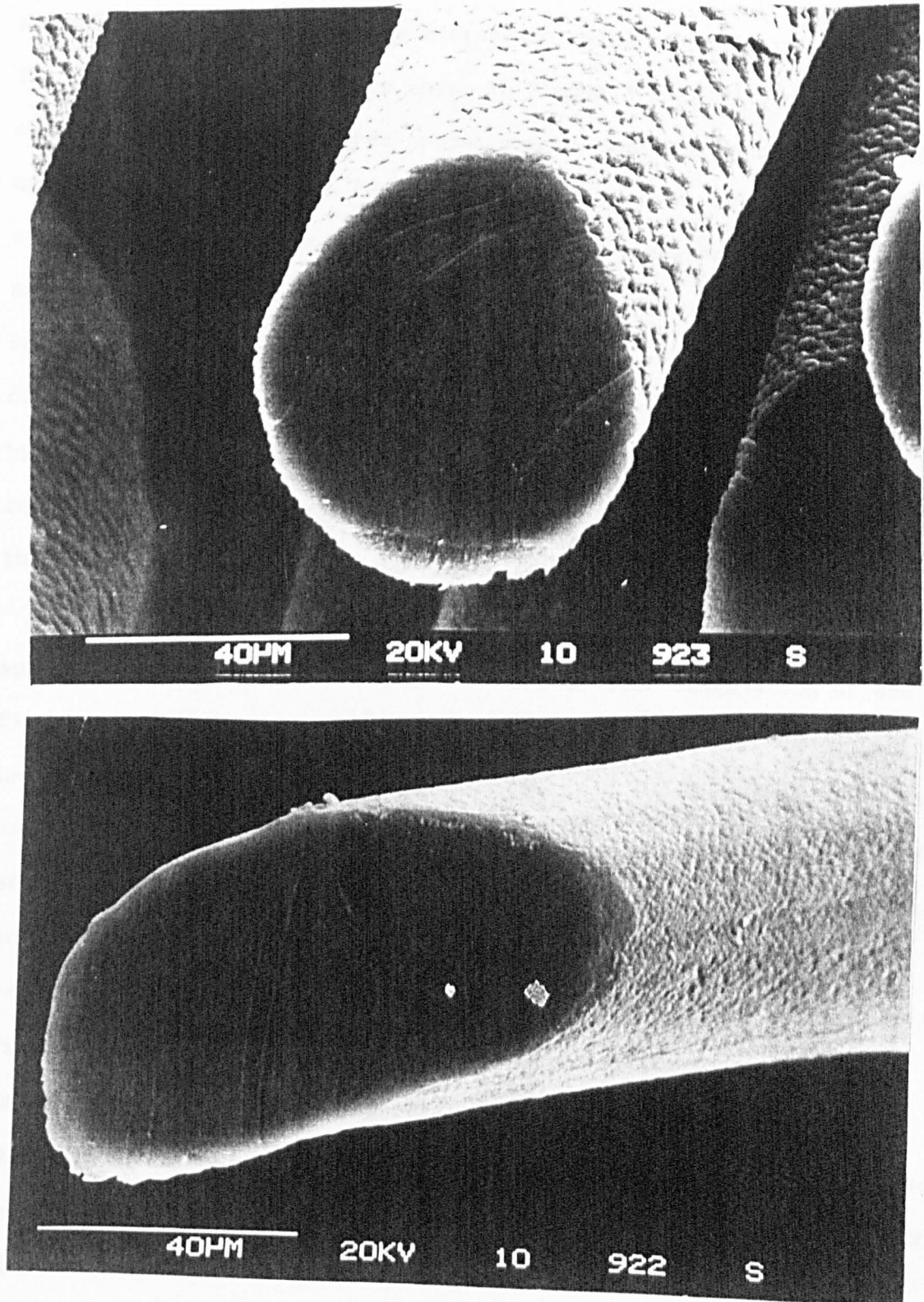

PLATE 3.1: Cross-section and surface structure of undrawn wet spun fibres dried under tension

Coagulant: (A) 100% water
(B) 75% DMA

photographed on the hot stage microscope using an ordinary camera. The photographs obtained are shown in Plates 3.2 (A), (B) and (C). The cross-sections of the fibres produced from high DMA content baths are quite different to those from low or no DMA content baths. The former samples have cross-sections which are highly irregular, while the latter samples look more nearly circular. Again, differences between the cross-sectional diameters of these samples are very obvious. These differences cannot be easily explained but they must have been caused by differences in exchange mechanism during coagulation. There is an indication of poor coagulation with more solvent getting trapped in the filaments as the bath gets richer in DMA.

It had become obvious by now that the major difficulty in the spinning of chitin fibres was as a result of poor coagulation of the fibres. But a review of the coagulation composition of those spinning processes using amide-LiCl as solvent (section 3.2.2.2) shows that the use of 100% water or amide-water as coagulants is common. However, some of the coagulants also involves the use of aqueous salt solutions alone or in combination with an amide. Therefore, it was considered reasonable to spin into baths containing water/LiCl and DMA/LiCl/water. Fibres were wet spun under similar spinning conditions as indicated under Table 3.4. The results obtained are also shown in the table. When the results were compared with those from 100% water and DMA/water baths, it became apparent that the fibre properties did not alter much with changes in the coagulation compositions. However, changes were observed in spinnability. As the bath became richer in DMA, filaments became weaker and breakages increased in the bath. It was observed too that filaments spun into aqueous lithium chloride solution were extremely



A

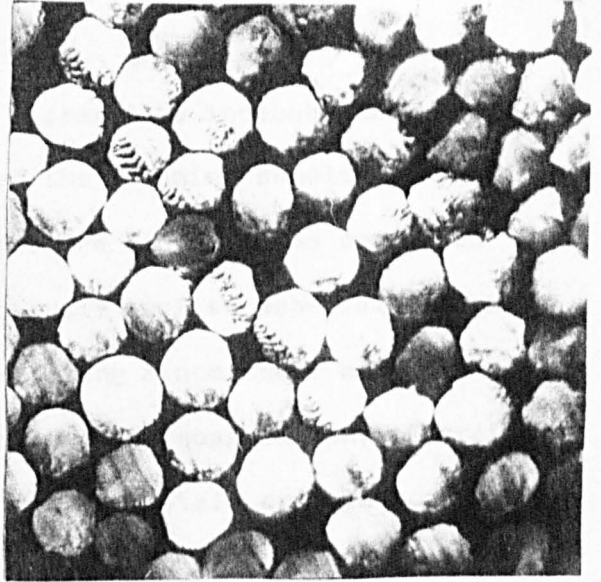

B

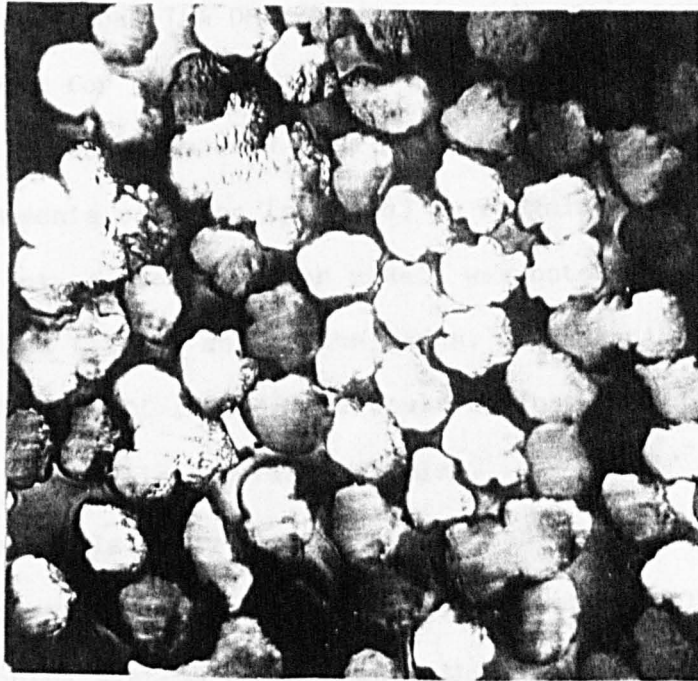

C

PLATE 3.2: Effect of DMA content in the coagulant bath on cross-sectional shape of wet spun fibres

Coagulants: (A) 25% DMA
(B) 67% DMA
(C) 83% DMA

weak and broke frequently in the bath but were nevertheless reasonably strong after washing and drying.

The results of the experiments appeared to indicate that addition of DMA or LiCl in the bath under the spinning conditions shown was a minor variable as far as improving fibre tenacity was concerned. The fact that the fibres obtained were heavily swollen especially from DMA and/or LiCl baths was not at all surprising since their addition would no doubt reduce the rate of an already slow coagulation. Therefore, part of the aim of the experiment, which was to obtain coagulation bath compositions capable of deswelling the fibres, was not achieved, and a decision could not be made on the best single bath composition. However, for the extreme lustre obtained from high DMA baths, it was decided for future work to choose 75% DMA:25% water as the main coagulant. Water was also chosen for comparison; to discover if acid or alkali had an effect, some experiments were done using dilute acetic acid (pH 3.4) and dilute ammonia solution (pH 10.6) as coagulating baths. (In the event no effect of added acid or alkali was noted.) No further attempt was made to add LiCl to any of the baths, although it was understood that part of the LiCl in the dope would diffuse into the baths and slightly alter their compositions during spinning.

Since relatively no improvement had been obtained with wet spinning, it was decided to try the dry-jet wet-spinning technique. In most spinning systems where this method has been used, numerous advantages such as increase in fibre tenacity, extensibility, tensile factor, smoothness etc. were cited over wet spinning [113,122,123]. However, since this was the first attempt to spin chitin fibres using the dry-jet wet-spinning technique, there was no certainty of success. After

some initial failures, fibres were spun using various compositions of DMA/water as coagulant under the spinning conditions shown below Table 3.4. The results were thought to be successful, although some of the filaments were observed to twin. However, this was not considered a major problem since it could be surmounted easily. Tests carried out on both the coalesced and single filaments showed similar strength and extensibility. In comparison with wet spun fibres, such results obtained indicated that tenacity and tensile factors were only slightly higher for dry-jet wet-spun fibres and appeared to have improved as the bath got richer in DMA. The extension, on the other hand, was lower than those of wet spun fibres and like wet spun fibres, decreased with increasing DMA in the bath. The lower extensibility as compared with wet spun fibres was due perhaps to the high jet stretch ratio used for spinning DJWS fibres. It was observed that fibres obtained by DJWS were all very lustrous. The surface structure of the fibres was also different from those of wet spun ones. The fibres all had a smooth surface as shown in Plate 3.3(b). Surprisingly, both methods produced fibres with apparently voidless internal structure (Plates 3.2 and 3.3(a)). What appears to be voids on the cross-sectional photographs are cutting faults.

Although the use of DJWS resulted in slight improvement in fibre strength, it was believed that the major factor preventing marked improvement in fibre properties was the slow rate of coagulation. It was therefore decided to study in more detail the coagulation behaviour during the spinning process. The results of this work are discussed in chapter 6.

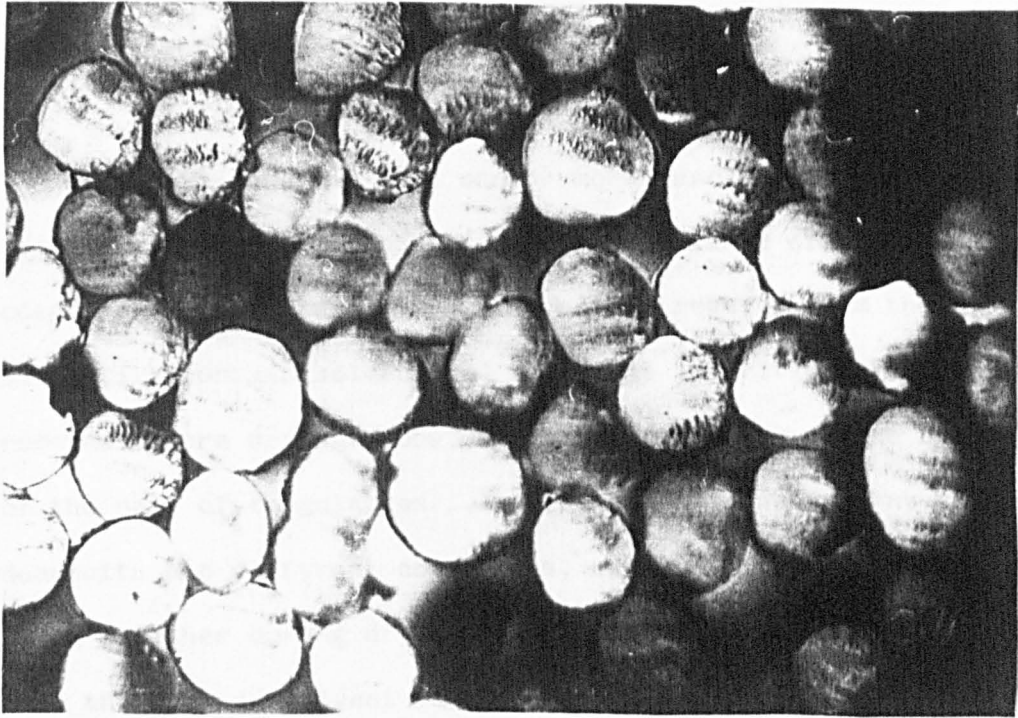

(A) Cross-section

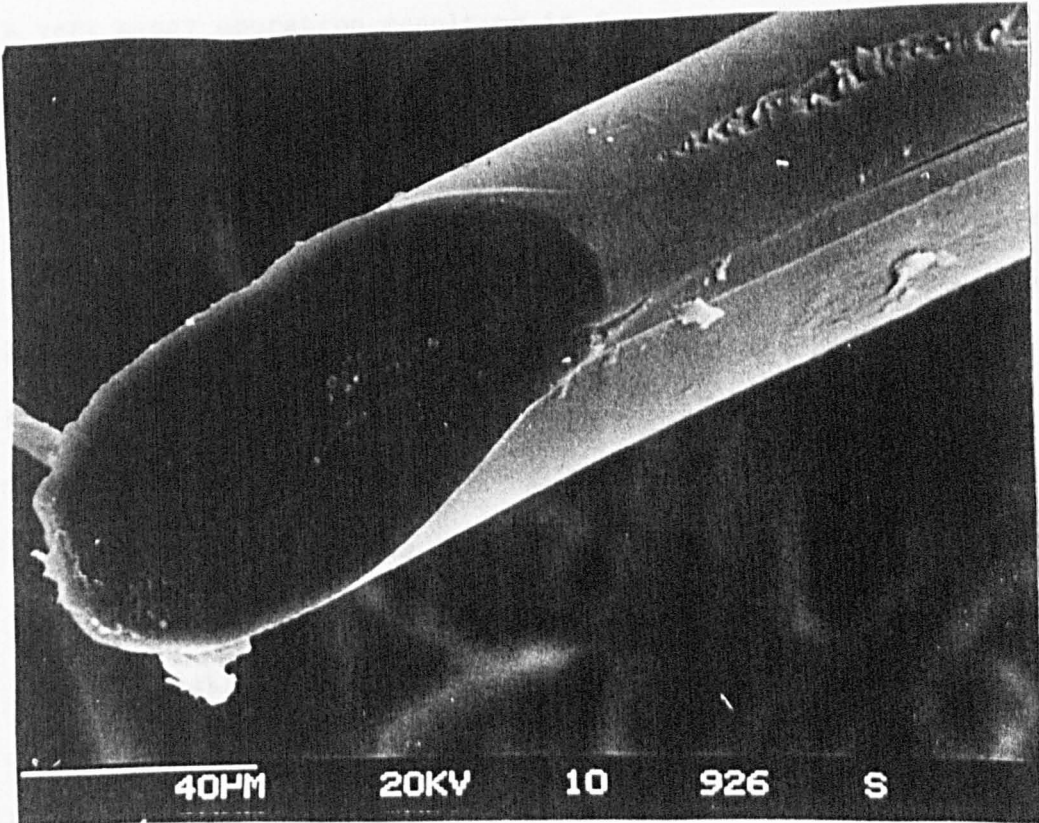

(B) Surface structure

PLATE 3.3: Cross-section and surface structure of undrawn DJWS filaments dried in an oven under tension (Coagulant: 50% DMA)

3.2.2.2 Studies on the effect of washing on fibre properties

After coagulation, one or more washing stage(s) is a common operation in solution spinning. The importance of this is simply that coagulated filaments as they are quickly removed from the coagulation bath still contain solvent and sometimes impurities which must be removed before drying. How much solvent is left in the filaments depends on the rate of coagulation. In all cases of the present spinning trials done with the different coagulants, swollen filaments which tended to stick together during drying were formed. On heating, it was presumed that the trapped solvent began to diffuse out and consequently the surfaces of the filaments became wet and sticky with solvent. This caused a very messy operation resulting in frequent breakages of the filaments as they stuck together and to the surfaces of the chrome drying rollers. The problems were not surmounted even after the filaments were washed in warm water (60°C) and passed through a hot water draw bath at 80-85°C before drying. Since filament adhesion was mostly during drying, it was decided to carry out a series of washing operations to establish washing arrangements which would prevent adhesion during drying on the machine, in air or in an oven.

To start with, a literature search was carried out to find out the details of those spinning procedures using amide-LiCl systems. This involves mostly aromatic polyamides such as Nomex, poly(m-phenylene isophthalamide) which are dissolved in amide solvents with an addition of LiCl to improve solvent power.

King [124] in his process for wet spinning of such polymers employed two successive water extraction baths. In the first bath, the

filaments (after coagulating in a solution containing at least 40% calcium thiocyanate, no more than 25% DMA and water) were passed around the roller fifteen times and washed in water at 20°C for about 0.5-2 minutes. They were then passed around the second roller six times and further washed in water at 20-95°C for 10-30 seconds. Teijin [125] in a similar process employed a system in which the filaments were washed in water before passing through a hot water draw bath at 95°C. The coagulation bath contained an aqueous solution of calcium chloride plus another salt such as zinc chloride or aqueous solutions of calcium chloride plus no more than 3% of an amide at 60°C or above. Monsanto [126] recommended a method in which two main dip baths were used, one of them on the first godet and the other one on the draw rollers. The first bath contained boiling water or a solvent extraction agent such as an alcohol (ethanol, isopropanol etc.) or an aqueous solution of an amide (50% DMA in water or 37% urea in water). After the first washing, the filaments were passed through a hot or boiling water draw bath and over the draw rollers where they were further washed in water at 15-65°C. They were then passed through a finish bath before drying. The coagulation bath contained either 1-10% DMA/water or a mixture of 70-95% water/5-30% polyalkylene glycol. They claimed that the use of the extraction agent eliminated any tendency for fibre cementation and improved the rate of drying. Kwolek [127] suggested passing the filaments through a finish bath and winding up on bobbins which could then be soaked in cool running water for 3 hours or overnight; the filaments could then be dried at room temperature. They further suggested that it was possible to remove most of the residual solvent by passing the filaments through aqueous baths flushed with water as the bobbins or skeins were formed.

The spinning of Nomex from DMA-5% LiCl along with other polymers was also described by Hancock et al [128]. The solution of Nomex was spun into either water or 5-15% DMA/water or 5% NaOH/water. Filaments produced were described as tacky. They claimed to have successfully surmounted the problem by applying a water spray to the filaments as they were taken up from the coagulation bath. Cellulose also dissolves in DMA-LiCl. Turbak et al [129] described a method of spinning cellulose from this solvent in which the polymer solution was spun into a bath containing one or more of the following: alcohols, pyridine, acetonitrile, water and tetrahydrofuran. The filaments produced were washed with water at 65°C, squeezed dry, soaked in a finish bath, centrifuged and dried in an oven at 100°C overnight.

From this review, it appeared that most washing sequences involved two stage water extraction baths or two successive baths, water first and alcohol second. However, as earlier indicated, successive washings in cold or hot water did not prevent filaments from sticking together. In any case, it was decided that cold water, hot water and methanol be tried firstly as single wash baths and then as successive wash baths in various combinations. The lack of success in the earlier spinning trials might have been due to too short washing times; therefore attempts were made to wash the filaments for longer periods. The solubility of LiCl in various solvents shown in Table 3.5 made water and methanol particularly obvious choices.

The heavily swollen filaments, coagulated in water acidified to pH 3.4, were wound twice on the first roller and fifteen times on the second roller of the first pair of advancing reels. Spinning was stopped and the filaments were then washed in cold water in a bath

TABLE 3.5: Solubility of lithium chloride in various solvents [130]

<u>Solvent</u>	<u>Solubility (g/100 g solvent)</u>
Water (25°C)	45.85
Water (80°C)	52.80
Water (100°C)	56.20
Methanol (20°C)	30.50
Ethanol (20°C)	24.28
Propanol (25°C)	16.22
n-Butanol (16°C)	8.91
Acetone (0°C)	1.70; 4.40; 10.11*
Acetone (25°C)	3.94, 7.67*
Methyl acetate (20°C)	12.10
Ethyl acetate (19°C)	0.0003
Ethyl diamine (25°C)	1.39
Pyridine (28°C)	13.47

*Different authors

placed below the second roller. After about 2 minutes washing, the filaments were collected and dried either in air at room temperature overnight or in an oven at 70-75°C for 1.5 hours. Normally when filaments were coagulated and/or washed, they contained large amounts of surface liquid which apart from making drying more difficult, was also presumed to be partly responsible for fibre adhesion after drying. Some samples similarly prepared were therefore centrifuged before drying in air or in an oven, or centrifuged and further washed in hot water (75°C) for 40 minutes and methanol for 2 minutes before drying in air. The entire experiment was then repeated using for washing (a) hot water (75°C), (b) methanol and (c) both liquids used successively in either order. Samples that were not washed at all but which were wound twice on the first roller of the advancing reels were also collected and dried as described above. The results obtained are shown in Table 3.6. As the table shows, five samples obtained from each washing sequence were dried either in air, oven or centrifuged before drying in air or oven. The essence of this was to compare simultaneously the effect of different washing and drying conditions on the fibre properties. Fibres were collected in hank form after washing and dried without tension. The mechanical properties obtained for each sample are shown in the table. The spinning conditions are given at the foot of the table.

(i) Unwashed samples: filaments were very sticky and difficult to dry. Those that were dried in the oven stuck together and were inseparable. They were yellowish, brittle and could easily be crushed into pieces. When allowed to stand in air after drying in the oven for about 10 minutes, filaments became flexible and difficult to crush

TABLE 3.6: Studies of the effect of washing and drying on fibre properties

Sample No.	Fibre properties	WASHING ARRANGEMENTS							
		Cold water	Hot water	Methanol	Cold water Hot water	Cold water Methanol	Hot water Methanol	Methanol Hot water	Cold water Hot water Methanol
		<u>Dried in air</u>							
3-25	T(g/dtex)	0.74	0.68	0.71	1.00	0.93	0.90	0.80	1.14
	E(%)	36.10	41.35	45.80	32.30	42.65	40.30	40.30	32.70
	TE ¹	4.45	4.37	4.80	5.68	6.07	5.71	5.06	6.52
		<u>Dried in the oven</u>							
3-26	T(g/dtex)	0.70	0.78	0.79	0.88	0.94	0.95	0.90	1.00
	E(%)	38.30	32.60	46.95	38.06	41.90	41.25	41.25	41.95
	TE ¹	4.33	4.45	5.41	5.43	6.08	6.10	5.78	6.48
		<u>Centrifuged then dried in air</u>							
3-27	T(g/dtex)	0.82	0.86	0.86	0.94	1.06	1.06	0.94	1.10
	E(%)	44.88	46.22	48.05	38.50	44.60	43.90	40.70	48.15
	TE ¹	5.49	5.85	5.68	5.83	7.08	7.02	6.00	7.63
		<u>Centrifuged then dried in the oven</u>							
3-28	T(g/dtex)	0.80	0.77		1.01	1.06	1.12	0.96	1.11
	E(%)	41.64	40.00		39.67	46.10	41.30	46.13	38.60
	TE ¹	5.16	4.87		6.36	7.20	7.20	6.52	6.90
		<u>Centrifuged, further washed in hot water and methanol and finally dried in the oven</u>							
3-29	T(g/dtex)	0.83	0.79	0.75	0.91	1.06	1.10	0.96	1.12
	E(%)	45.83	48.00	50.83	45.94	44.50	37.00	49.00	47.17
	TE ¹	5.62	5.47	5.35	6.17	7.04	6.69	6.72	7.69

Spinning conditions (3-25 to 3-29)

Chitin: C3-2

Dope spun on the 5th day of ageing

Dope concentration 7% chitin 8% LiCl

Bath composition = 0.1% aqueous acetic acid (pH 3.4 at 20°C)

Pump speed: 3 rpm

First advancing reel speed 18 rpm (10.3 m/min)

Linear extrusion rate 17 m/min

Jet stretch ratio = 0.6

Pot and block temperature 60°C

Nitrogen pressure 15 lb/in²

Spinneret 150 µm, 10 holes

Filaments dried without tension in the oven (70-75°C) for 1.5 h or in air overnight

Bath length 120 cm

Average fibre count 37 dtex

but very weak. Filaments dried in air were also too weak to be tested. Those samples centrifuged before drying were only slightly less sticky but very weak. It was possible to test those centrifuged and dried in air and they were found to have a tenacity of 0.25 g/dtex, extensibility 77.7% and tensile factor of 2.19. Samples centrifuged and dried in the oven were still very brittle and were therefore not tested.

(ii) Cold and/or hot water wash: filaments were tender, difficult to dry and when dried stuck together. A great contraction in length occurred during drying. Filaments were harsh, due to adhesion. Drying was only slightly easier after centrifugation, and filaments still stuck together. Further washing after centrifugation made drying very easy and filaments became free.

(iii) Methanol wash: tenderness reduced. No difficulty observed with drying and filament separation became good. Great contraction during drying. Samples centrifuged were very easy to dry. Filaments free.

(iv) Cold or hot water and methanol wash: easy to dry. Filaments free. Great contraction during drying.

It is clear from the results that washing was an important part of the spinning operation. When the washed filaments were compared with the unwashed sample, the results showed that the washed samples were stronger by a factor of 2-6 times approximately. The low strength of the unwashed sample could be due to solvent still trapped in the filaments, as could also be the high extensibility obtained. When such filaments were oven dried, they showed an initial brittleness which was soon replaced by a limpness on exposure to air due, presumably, to the hygro-

scopic nature of the LiCl still trapped in the filaments.

As to the question of what washing agent(s) to use, it was observed that apart from difficulties in drying, cold or hot water alone or in succession, produced filaments which were tacky, harsh and in some cases, brittle. However, when methanol was used alone, the rate of drying was increased and the brittleness slightly reduced, but the filaments were even harsher. Filaments washed with methanol after cold or hot water washes were also harsh, though with further improvement in the rate of drying. However, it was observed that the strength of the fibres had increased, though by a small fraction - with no substantial effect on extensibility when compared with samples washed in methanol alone. Surprisingly, when the washing order was changed to methanol-hot or cold water instead of hot or cold water-methanol wash, various changes were noticed; the filaments became difficult to dry, being slightly tacky and they were weaker. Then it was observed that a three stage washing procedure, cold water-hot water-methanol, produced fibres which were soft to handle with little change in tenacity. It was also noticed that as the number of washings increased, fibre diameters decreased (no wash 75 μm ; single wash 60-60.5 μm ; double or triple wash 56-58 μm , except samples that were given methanol/hot water wash 60 μm). Earlier, it was presumed that the improvement in fibre properties with washing was due to loss of solvent, but these changes observed in fibre diameters suggest that apart from the loss of solvent, such improvement might have been due to stretching of the filaments (though not deliberately) when wound around the advancing reels. A similar conclusion was earlier presumed in section 3.2.2.1. It appears from the results that drying the fibres in air or in the oven did not seem to matter very much.

However, the results were not consistent. What was consistent was that the fibres dried in the oven were always harsher than those dried in air. It was also found that fibres centrifuged were always easier to dry, less tacky and of better tensile properties. The reason for this was not clear, but it was an indication that proper removal of the surface liquid on the filaments before drying improved filament freedom and reduced adhesion.

From these results, it became very clear that in order to reduce fibre adhesion during drying, it was important to have washing arrangements in which the fibres were washed finally in a methanol bath (and then centrifuged where possible). Although such arrangements made it easier to dry the filaments continuously on the chrome drying rollers, as will be shown in section 3.2.2.3, those dried on the rollers became very brittle. Furthermore, there is no doubt that the extensibility of the fibres produced in this series of experiments was higher than those observed on the previous experiments (Tables 3.1 to 3.4). The reason for this was ascribed to drying of the fibres without tension. As a result of these experiments, it was decided that, in general, fibres would be washed successively in hot water and methanol before drying in future experiments. Although it was observed that fibres centrifuged after washing were better in tensile properties and filament freedom, preparation of such fibres was time consuming and discontinuous. Furthermore, with the spinning equipment used in this work, it was only possible to have a two stage washing arrangement in a continuous spinning operation.

3.2.2.3 Effect of dope temperature and drying on chrome rollers (under tension) on fibre properties

As will be shown later in chapter 5, the viscosity of chitin dope decreased consistently with increasing dope temperature. In the next experiment, it was decided to investigate the effect of dope temperature on the mechanical properties of the fibre. The experiment was also designed to show the effect of drying the fibres under tension on the drying rollers after the fibres were washed in a hot water draw bath at 85°C (without drawing) and through a methanol wash bath placed under the second roller of the second pair of advancing reels. Fibres were also collected after the hot water draw bath and methanol wash and dried in the oven at 75°C without tension. On two occasions, fibres were stretched 12% in the hot water draw bath before washing in methanol and drying on the rollers. In all the cases, the dope was allowed to stand for 1 h at the spinning temperature to equilibrate before spinning was started. The samples were produced by wet spinning under the same spinning conditions, except for the different drying technique, and for the two samples drawn 12% before drying on the chrome rollers.

Tables 3.7 and Figs. 3.3 and 3.4 show the effect of dope, temperature on the fibre properties for the two different drying techniques. It is clear from these results that an increase in dope temperature up to 60°C did not appear to have affected the mechanical properties of the wet spun fibres, due perhaps to the low coagulation bath temperature (15°C) used; this must have lowered the temperature of the dope since the spinneret was wholly immersed in the bath. However, at dope temperatures above 80°C, some effect was noticeable. While no change was observed in tenacity for fibres dried on the chrome rollers, those dried relaxed in

TABLE 3.7: Effect of dope temperature on fibre properties
(under two different drying conditions)

Sample No.	Dope temp. (°C)	Tenacity, T (g/dtex)	Extensibility, E (%)	Tensile factor (TE ^{1/2})
<u>Dried in oven at 75°C relaxed</u>				
3-30	20	1.00	33.0	5.74
3-31	40	0.97	34.2	5.67
3-32	60	0.98	35.8	5.86
3-33	80	0.97	34.2	5.67
3-34	100	0.93	35.9	5.57
3-35	120	0.87	26.5	4.48
<u>Dried on the chrome drying rollers under tension</u>				
3-36	20	1.23	18.8	5.33
3-37		(1.40)	(8.0)	(3.96)
3-38	40	1.19	19.6	5.27
3-39	60	1.23	18.6	5.30
3-40		(1.43)	(7.1)	(3.81)
3-41	80	1.18	16.2	4.75
3-42	100	1.20	16.0	4.80
3-43	120	1.21	17.0	5.07

() drawn by 12%

Spinning conditions (3-30 to 3-43)

Chitin: C3-2

Dope concentration: 7% (w/w), 8% LiCl (w/w)

Spinneret: 150 μm, 10 hole

Jet stretch ratio: 0.6

Coagulation bath ≈ 0.1% aqueous acetic acid (pH 3.4) at 15°C

Average fibre count a) dried in oven 30 dtex

b) dried on roller 25 dtex

c) drawn 22.5 dtex

Drying temperature: 130°C

Bath length: 120 cm

FIG. 3.3: Effect of dope temperature on tenacity under two different drying conditions

- Dried under tension on chrome rollers
- Dried in an oven relaxed at 75°C

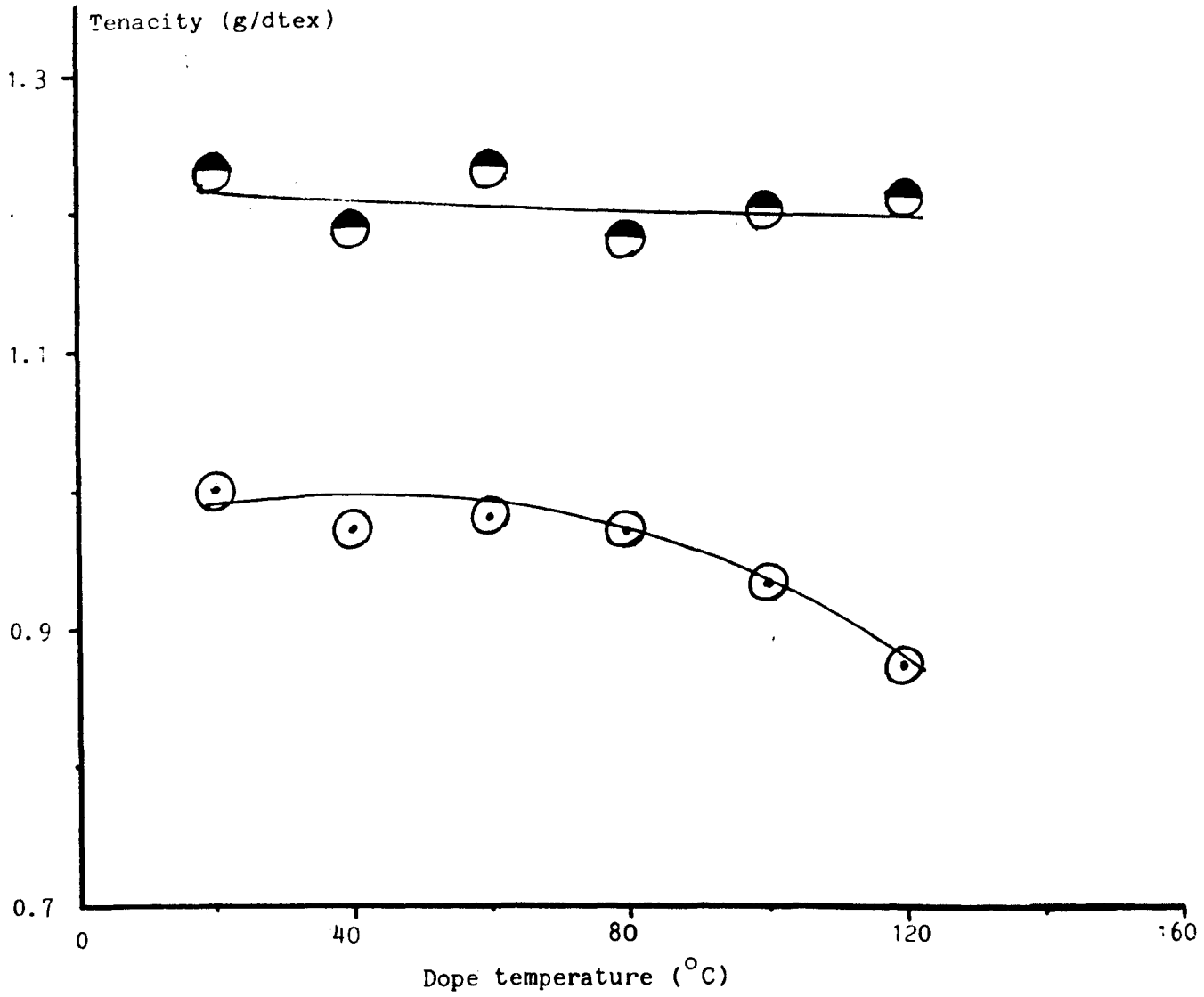
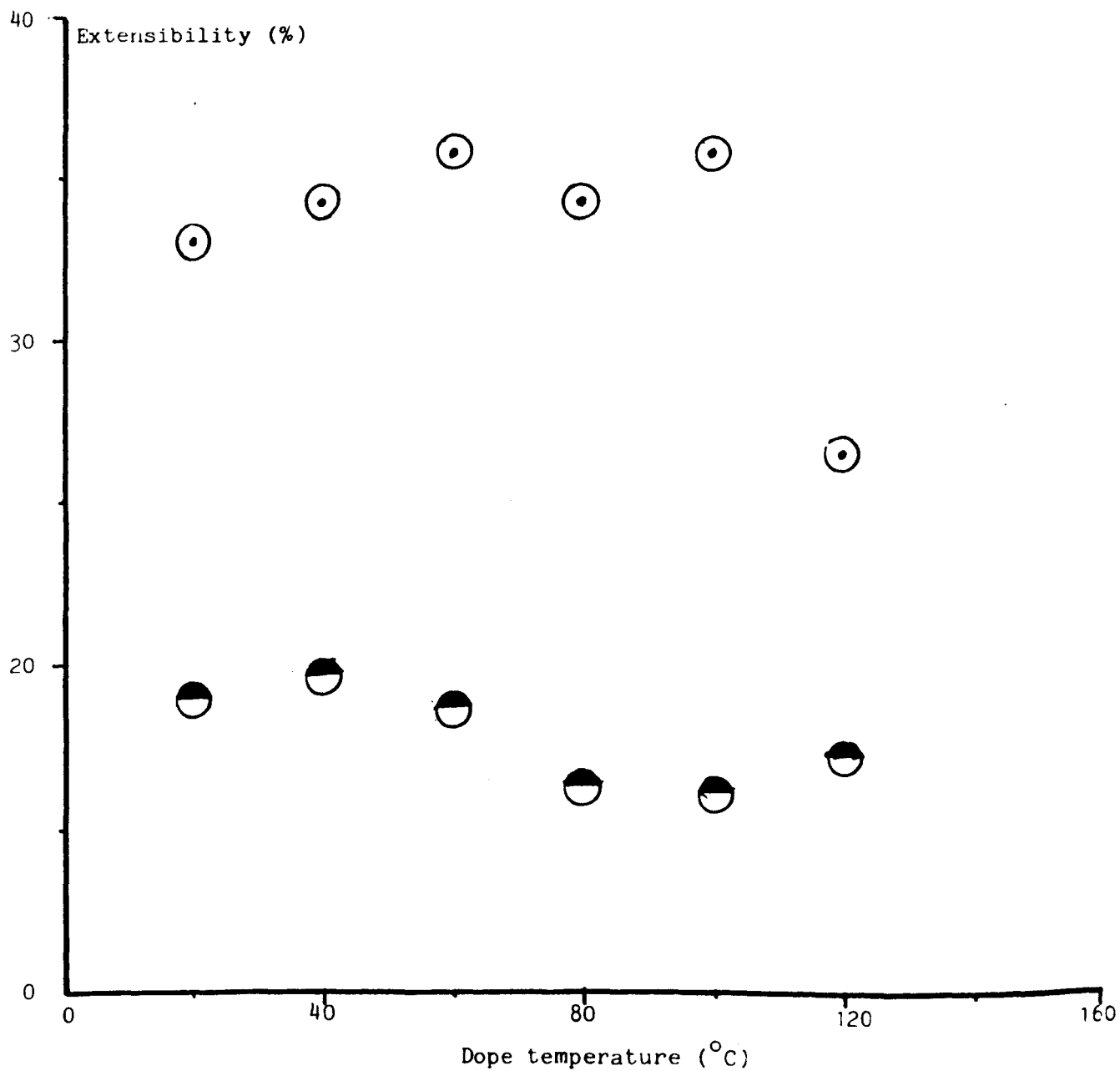

FIG. 3.4: Effect of dope temperature on fibre extensibility under two different drying conditions

- ⊙ Dried in an oven relaxed at 75°C
◐ Dried under tension on chrome rollers



the oven showed a slight decrease in tenacity at dope temperatures above 80°C . On the other hand, the extensibility of the fibres dried in the oven appeared to be unaffected by changes in dope temperature except for a very low extension obtained from the dope at 120°C . The reason for this is not clear since similar fibres dried on the chrome rollers showed no such loss in extension. However, a critical examination of the data and Fig. 3.4 showed that all the fibres prepared from dope at temperatures above 80°C and dried on chrome rollers have slightly lower extensions when compared with those spun from dope temperatures between 20 and 60°C . That the effect of dope temperature was more pronounced above 80°C can also be observed on a closer examination of the fibre tensile factors. Although the values of tensile factor appeared slightly inconsistent, the data show that above 80°C , the tensile factor of the fibres decreased.

The results also showed clearly the difference in fibre properties between drying fibres under tension on the chrome rollers as opposed to drying relaxed in the oven. For drying, the filaments were passed round the first chrome roller and the idler with six turns and with five turns around the second roller and its idler. The surface speed of the rollers was set so that no extension but slight relaxation took place between them and the second pair of advancing reels. In all the cases, the results show that the values of fibre extensibility dried under tension were almost half those dried relaxed in the oven. The tenacity of the fibres dried under tension had, on the other hand, increased by about 25%, indicating that the fibres had stretched during drying. Although those samples that were drawn, as well as dried on the rollers, showed a further increase in tenacity, they were extremely brittle and

had very low extensions at break. Since drying the fibres under conditions that prevented relaxation resulted in drastic reduction in fibre extensibility, and increased brittleness, it was decided that in future experiments, fibres would be dried without tension. Accordingly samples were, in subsequent work, dried in hank form, either in the oven at 70-75°C or in vacuum at room temperature. Incidentally, the fibre properties obtained from these drawn samples were relatively similar to those drawn samples previously obtained (Table 3.2), in spite of the obvious differences in chitin grade, time of hydrolysis, coagulation composition and solid content. This was an indication that these variables may not influence the fibre properties greatly under the spinning conditions used.

Examination of the dope reservoir at the end of spinning showed that where the dope was directly in contact with the reservoir, it had dried and stuck firmly to the walls. Where no contact was made, the dope had thickened and become yellowish. Under heat and pressure, it appeared that some DMA had evaporated from the dope, because part of it condensed on the reservoir lid. All the fibres prepared using dope temperatures at 100°C and above were yellowish. Although the dope viscosity must have increased with the evaporation of DMA, no change was observed in the spinnability as there was a steady flow throughout the spinning process, though filaments appeared weaker above a dope temperature of 80°C. Continuous spinning at temperatures above 80°C was possible because it was observed that the dope flowed steadily from the centre portion in the reservoir. However, the changes observed may be an indication that the spinning reservoir might have been overheated and the dope consequently gelled. A simple dope gelation test was

therefore carried out to investigate the effect of heat on chitin dopes. A test tube (pyrex) of length 10 cm and diameter 2.5 cm was used. Before use, the middle portion of the tube was scratched to produce two marks (5 cm apart). After the test tube had been almost filled with the dope, it was clamped vertically and then lowered into a water bath at $70 \pm 2^{\circ}\text{C}$ so that the dope was below the surface of the water in the bath. A ball bearing (weight 1 g) was then carefully dropped into the dope and the time it took the ball to fall between the two marks on the tube was recorded using a stop watch. After this, the tube was properly sealed, left in the bath at 70°C and thereafter the fall time of the ball was determined at 1 hour intervals for a period of 5 hours. Dope concentrations between 7 and 9% were examined and it was found that while the 7 and 8% dopes did not show any sign of gelation within the 5 hours, the 9% dope had almost completely gelled by the fourth hour. When the dopes were allowed to remain in the bath overnight, both the 8 and 9% had gelled. Gelled dopes were not thermoreversible. Although no gelation was observed with the 7 and 8% dopes at 70°C within 5 hours, it was considered a possibility at higher temperatures.

3.2.2.4 Effect of dope concentration

Among the coagulation variables mentioned earlier, a change in dope concentration was regarded as a sure means of varying tenacity, especially in acrylic spinning systems. It was therefore decided to investigate the effect of dope concentration on the properties of the fibres. Because spinnable chitin solutions could only be prepared within a small range of 5-9% by weight of chitin (see chapter 5), samples were

prepared from dopes containing between 6 and 8% chitin, using 8% by weight of LiCl. Although the range selected was very narrow, the difference in dope viscosities (16 and 58 Pa s at 30°C, 3.6 sec⁻¹ for 6 and 8% respectively) was very significant and should therefore produce changes in fibre properties for a sensitive spinning system. The samples were produced by both dry-jet wet-spinning and wet spinning. The results obtained and the spinning conditions used are shown in Table 3.8. The results indicated that the values of tenacity for both spinning methods changed only very slightly with dope concentration. A similar result was found in the spinning of alginate by Speakman and Chamberlain [131], and by Tang [132]. After a slight initial increase, these workers even noted that the strength of the yarns decreased with increasing alginate concentration. Speakman and Chamberlain were of the opinion that it was due possibly to excessive shear when the highly concentrated and viscous solutions were extruded at high velocity through the small holes of the spinneret used. Perhaps, the improved properties with increase in dope concentration observed in the spinning of acrylic fibres [113,117,121] was because the polymer concentration could be varied through a much bigger range (between 17 and 30% by weight). However, the tenacity of fibres produced in these experiments by DJWS was always significantly greater than the equivalent wet spun samples. The reasons for the increase were associated with the high jet stretch ratio (2.87) for the DJWS samples, since the earlier attempts using DJWS (Table 3.4) at low stretch ratio (1.3) gave only a small improvement. The extensibility of the fibres also changed only slightly for both spinning methods; a small but consistent increase with dope concentration was obtained, and at every concentration, the extensibilities

TABLE 3.8: Preliminary studies of the effect of dope concentration

Sample No.	Dope conc. (%)	Fibre diameter (μm)		Fibre count (dtex)		Tenacity, T (g/dtex)		Extensibility, E (%)		Tensile factor ($\text{TE}^{\frac{1}{2}}$)	
		WS	DJWS	WS	DJWS	WS	DJWS	WS	DJWS	WS	DJWS
3-44	6	49.0	47.0	26.0	24.0	0.90	1.42	35.0	20.5	5.32	6.43
3-45	7	50.5	48.3	29.0	27.5	0.95	1.45	36.8	21.6	5.76	6.73
3-46	8	51.3	52.0	33.5	31.0	0.88	1.39	37.5	23.4	5.39	6.72

Spinning conditions (3-44 to 3-46)

Chitin: C2-2; 8% (w/w) LiCl

Dope temperature: 60°C

Jet stretch ratio: a) dry-jet wet spinning 2.87 (300 μm , 10 hole)
 b) wet spinning 0.85 (150 μm , 10 hole)

Air gap (DJWS): 1.5 cm

Coagulant: $\approx 0.1\%$ aqueous acetic acid (pH 3.4) at 25°C

Bath length: 120 cm

Washed in hot water draw bath (85°C) and then methanol

Dried in an oven at 75°C , relaxed

of wet spun fibres were higher than those of DJWS fibres. In spite of the improvement in tensile factor for DJWS fibres, the brittleness of these fibres showed little improvement over the wet spun samples. However, DJWS fibres, like the previous samples, were very lustrous and pleasant to handle while the wet spun ones were dull with surface features similar to those shown in Plate 3.1(A).

So far, the strengths of the fibres obtained have been between 0.8-1.45 g/dtex for both wet and dry-jet wet-spinning, though it was believed that higher values of tenacity could be obtained. Therefore, as variations of the coagulation conditions have produced relatively small improvements, it was decided to examine the effects of equipment variables such as jet stretch ratio (most especially for DJWS) and spinneret hole size. At the same time, it was considered necessary to introduce other different types of coagulant from time to time into the main stream of experiments. In this way, a wider spectrum of coagulants would be examined without losing much time.

3.2.3 Effect of jet stretch ratio

In most spinning techniques, the production of highly oriented and strong fibres involves a systematic stretching operation which in solution spinning may take place in two stages: firstly, when the fibres are still in their partially coagulated stage in the coagulation bath, and secondly in a hot draw bath between two rollers rotating at different surface speeds. Jet stretch ratio (JSR) is the term used for describing the stretching operation in the coagulation bath and is defined as the ratio between the surface speed of the take-up roller and the linear rate of extrusion assuming plug flow. In wet spinning and dry-jet wet-spinning, various jet stretch ratios are possible depending on the

polymer type, dope concentration, spinneret hole size and coagulation composition and conditions, although the magnitude is often less than 1 for wet spinning and over 2 for dry-jet wet-spinning. Although the importance of jet stretch ratio is not as well defined in wet spinning as in melt spinning or dry spinning, it is believed that in some spinning systems, like acrylic, an increase in jet stretch ratio results in a decrease in density, and an increase in the number of voids [117]. Knudsen [117] has attributed the increase in void formation to a rupturing effect caused by severe stress created by the increase in jet stretching. According to Paul and McPeters [133], the JSR is an important factor in the subsequent drawing operation. It was established that the total draw ratio, R_t in acrylic and modacrylic fibres, was the product of the spin bath draw ratio, R_s and the actual orientation draw ratio, R . Spin bath orientation in both fibres was shown to be a function of the JSR (the former term being defined as the ratio of the take-up roller speed to the free velocity of the filaments) for a given spinneret hole.

Table 3.9 shows the effect of the JSR on the mechanical properties of the undrawn fibres spun by DJWS. JSR was altered by changing the filament take-up speed from the bath. The fibres were washed on the first and second take-up advancing reels with warm water (60°C) and methanol respectively. They were then manually collected in hank form and dried in an oven at $70\text{--}75^{\circ}\text{C}$. Figures 3.5-3.7 show the effect of jet stretch ratio on tenacity, extension, and tensile factor for three different spinneret hole sizes (150 $\mu\text{m}/10$ hole, S_1 ; 300 $\mu\text{m}/10$ hole, S_2 ; 400 $\mu\text{m}/8$ hole, S_3). The figures show that as jet stretch ratio is increased, the fibre extensibility decreases and the effect appears to be more pronounced as spinneret hole size decreases. The

TABLE 3.9: Effect of jet stretch ratio on mechanical properties of dry-jet wet-spun undrawn fibres

Sample No.	Jet stretch ratio	Fibre diameter (µm)			Fibre count (dtex)			Tenacity, T (g/dtex)			Extensibility, E (%)			Tensile factor (TE ^{1/2})		
		S ₁	S ₂	S ₃	S ₁	S ₂	S ₃	S ₁	S ₂	S ₃	S ₁	S ₂	S ₃	S ₁	S ₂	S ₃
3-47	0.85	47.3	100.0	142.5	24.5	109.5	222.5	1.12 (0.25)	0.94 (0.20)	0.75 (0.16)	30.8 (41.6)	34.0 (46.0)	33.4 (50.0)	6.2 (1.6)	5.5 (1.4)	4.3 (1.1)
3-48	1.84	29.5	59.8	79.3	9.5	39.0	68.8	1.42	1.39	1.30	18.0	24.5	31.0	6.0	6.9	7.2
3-49	2.87	23.0	46.5	60.0	5.3	23.0	39.4	1.66 (0.16)	1.52 (1.21)	1.51	8.6 (7.2)	20.4 (22.4)	25.9	4.9 (0.4)	6.9 (1.0)	7.7
3-50	4.00		41.2	50.1		17.8	27.5		1.38	1.56		14.3	22.3		5.2	7.4
3-51	6.00		31.5	41.3		10.9	17.3		1.20	1.36		10.6	20.4		3.9	5.4

S₁ 150 µm, 10 hole spinneret
 S₂ 300 µm, 10 hole spinneret
 S₃ 400 µm, 8 hole spinneret

() under wet conditions

Spinning conditions (3-47 to 3-51)

Pump speed: 5.3 rpm for S₂ and S₃; 3.0 rpm for S₁
 Coagulant: ≈0.1% aqueous acetic acid (pH 3.4) at 20°C
 Coagulation bath length: 120 cm
 Air gap: 1.5 cm
 Chitin: C2-2
 Dope concentration: 7% (w/w) chitin, 8% (w/w) LiCl
 Dope temperature: 60°C

FIG. 3.5: Effect of jet stretch ratio on the tenacity of dry-jet wet-spun undrawn fibres

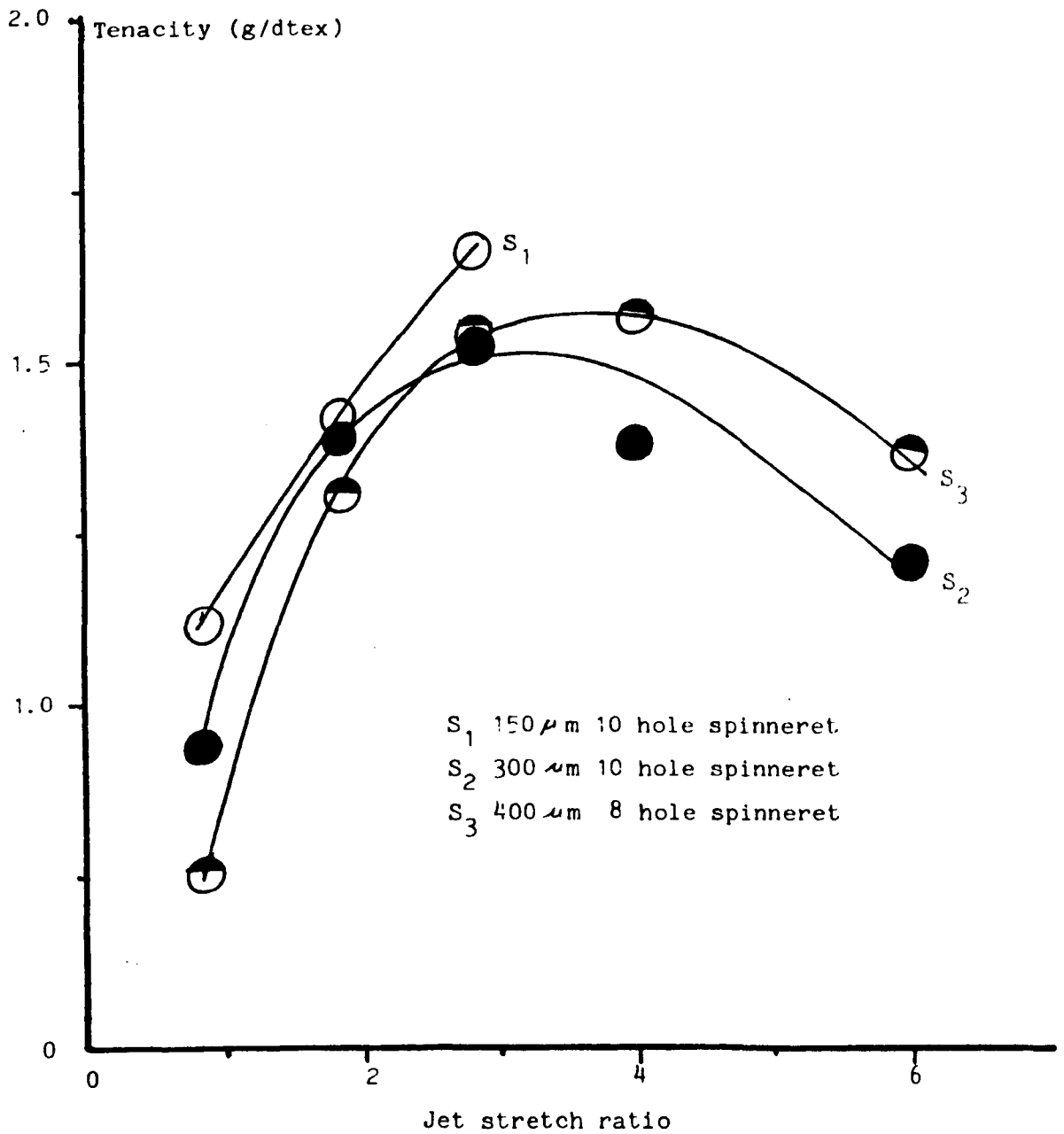

FIG. 3.6: Effect of jet stretch ratio on the tensile factor of dry-jet wet-spun undrawn fibres

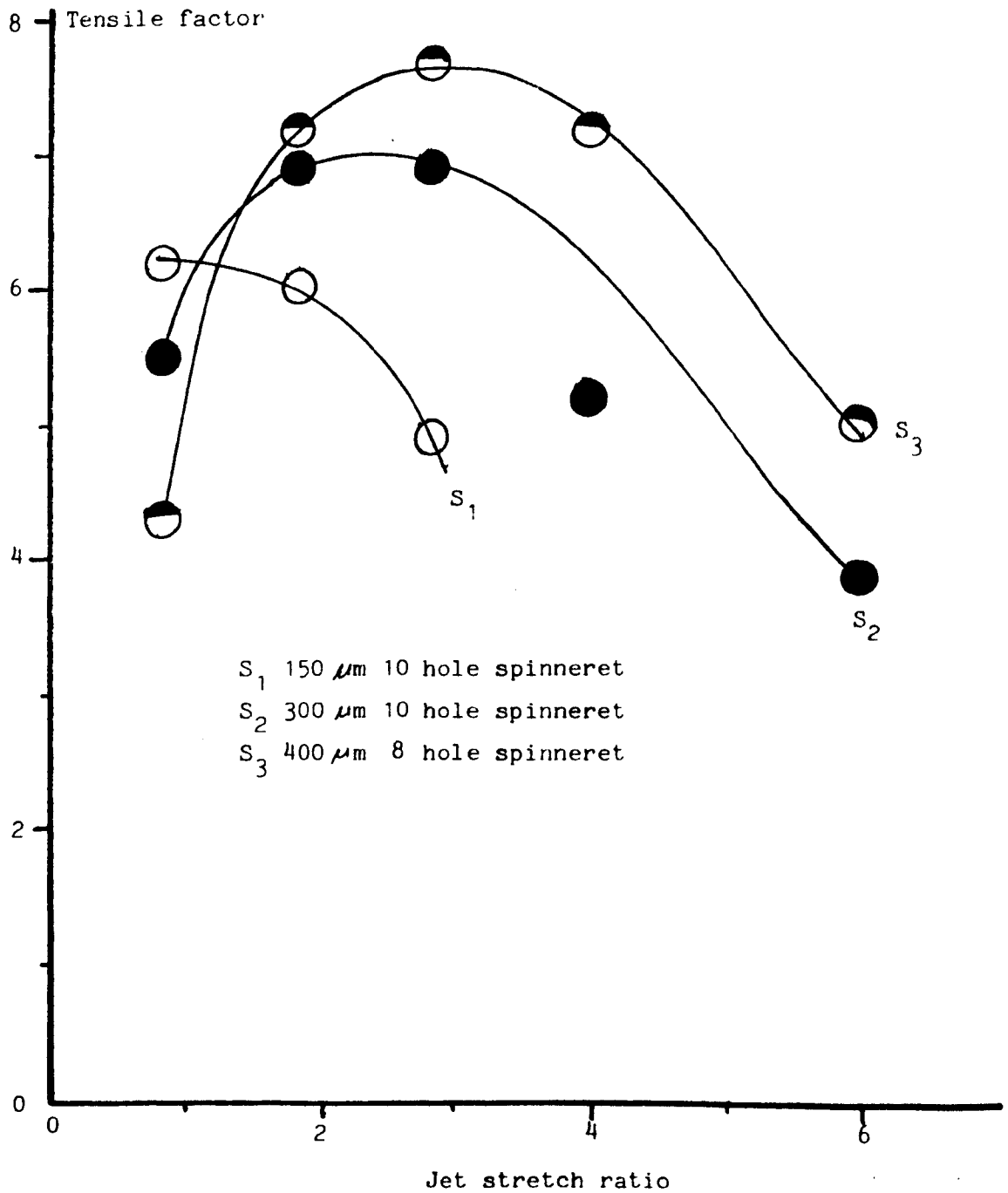
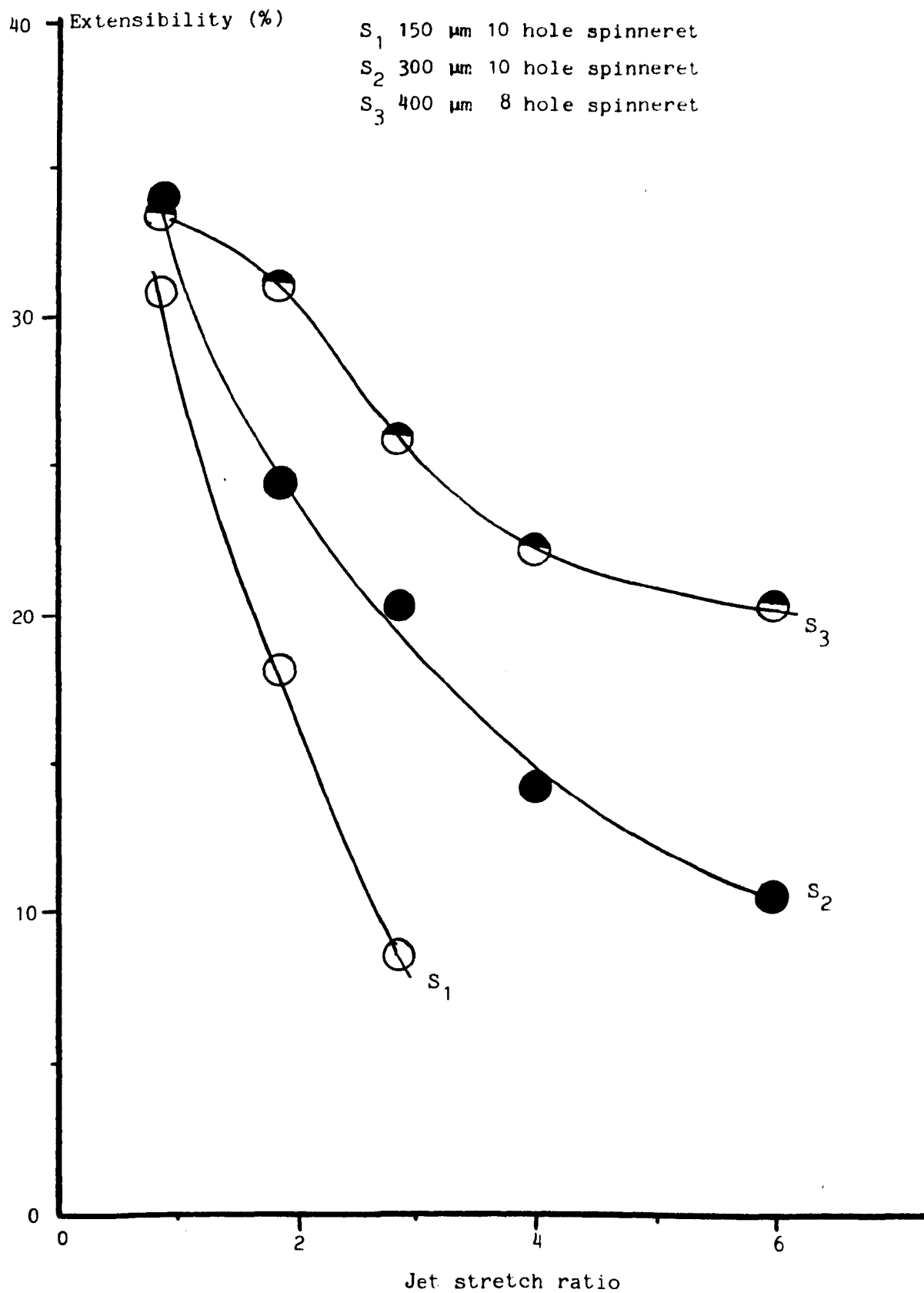

FIG. 3.7: Effect of jet stretch ratio on the extension of dry-jet wet-spun undrawn fibres



fibre tenacity, on the other hand, increases linearly with the JSR up to a JSR of 2.87 for the 150 μm spinneret and shows a maximum for the 300 μm and 400 μm spinnerets at JSR of 3-4. According to the X-ray diffraction patterns (Plates 3.7 and 3.8), the fibres spun at a low jet stretch ratio of 0.85 were slightly crystalline and low in orientation. At this ratio, the fibres were under no tension in the coagulation bath (indeed some twinning occurred) as is indicated by the higher fibre diameters obtained. As the jet stretch ratio increases, orientation is gradually introduced into the fibre along the longitudinal direction which corresponds to the direction of stretching along the fibre axis. Plate 3.8 shows that at JSR of 6, the fibres produced were fairly well oriented and crystalline. However, it appears that the fibres had little lateral orientation. Plates 3.4 and 3.5 show the electron micrographs of some selected fibres at low and high jet stretch ratios respectively at the magnification indicated. Fibres produced below a jet stretch ratio of 4 for the two large spinneret hole sizes had smooth and lustrous surfaces, but above this ratio, the surfaces had fibrillar-like features (Plate 3.5) and a characteristic surface rupture (Plate 3.6) similar to the surface feature Knudsen [117] described. Above this ratio, the frequency of fibre breakage was also high and fibres produced were brittle and could not withstand knotting. Although the strongest fibres were produced from the smallest hole diameter spinneret, (150 μm), it was difficult to produce fibres using this spinneret because of the frequent fibre breakage in the bath and partial hole blockage which caused artificial build up of dope on some holes. Above a jet stretch ratio of 1.84, it was almost impossible to spin continuously with this spinneret. It was found that the improvement in fibre tenacity with

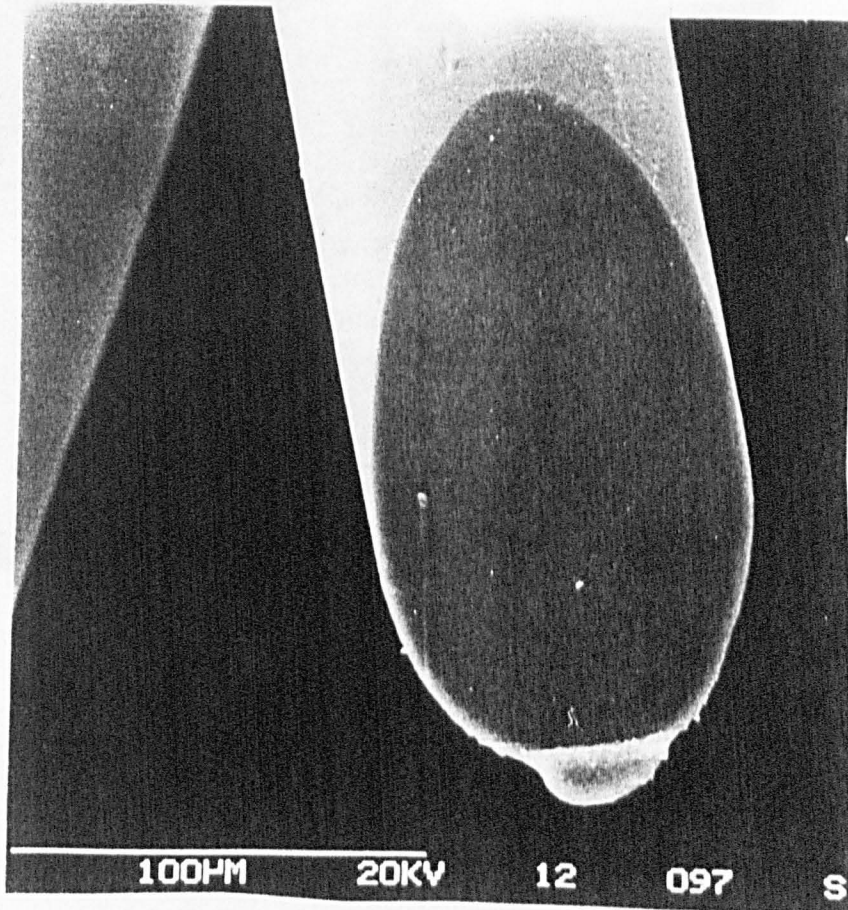
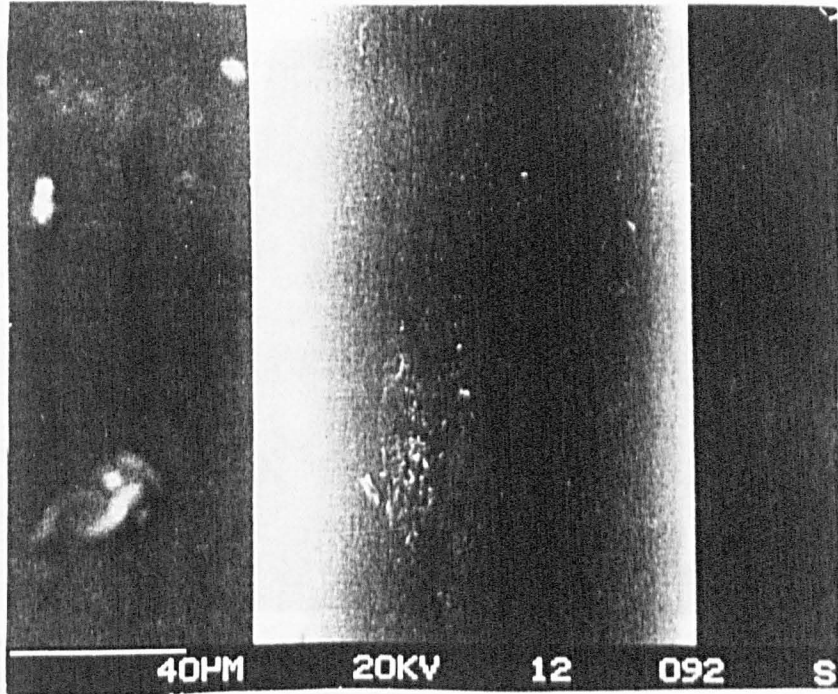

PLATE 3.4: Surface structure and cross-section of undrawn DJWS fibre at jet stretch ratio of 0.85 (coagulant: $\approx 0.1\%$ aq. acetic acid, pH 3.4; spinneret: 300 μm , 10 hole)

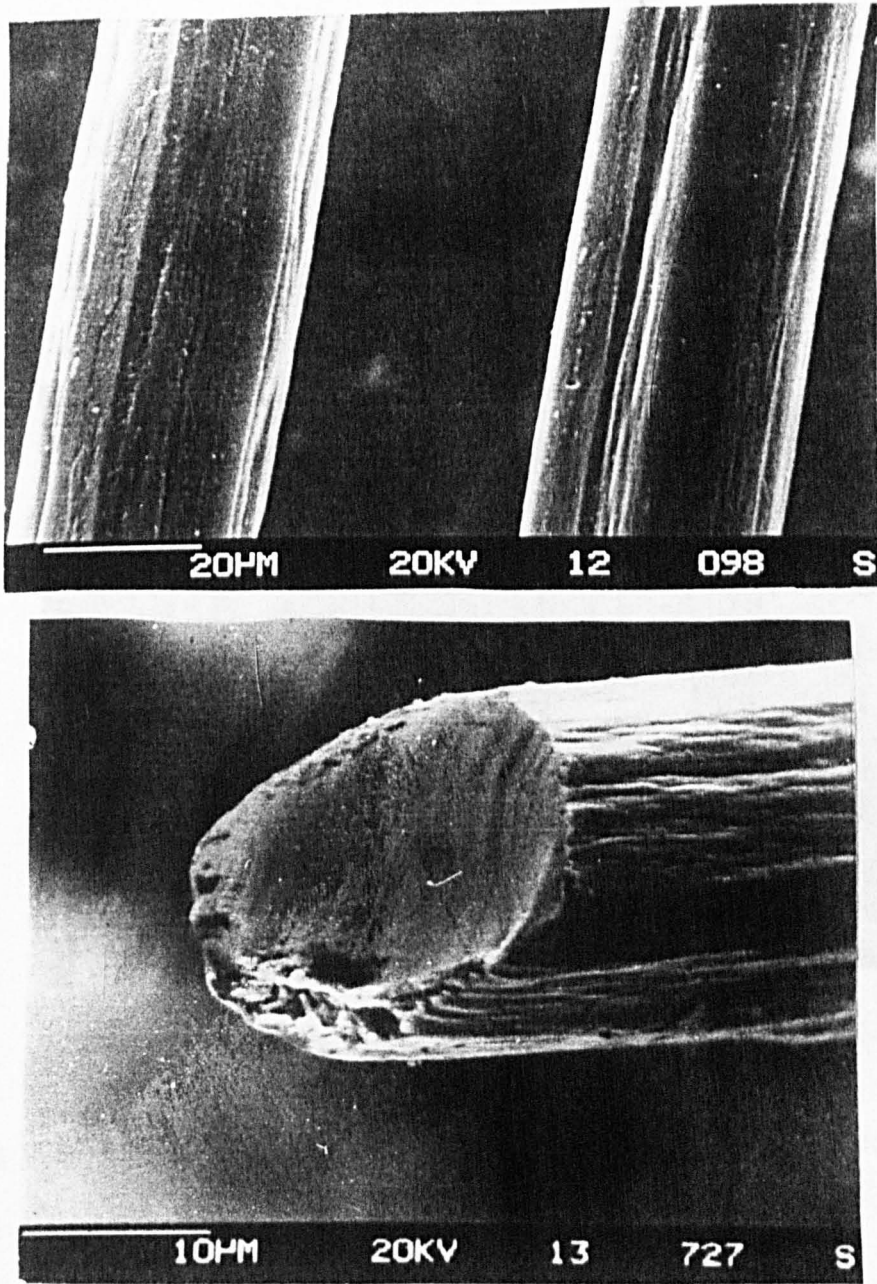

PLATE 3.5: Surface structure and cross-section of undrawn DJWS fibres at jet stretch ratio of 6 (coagulant: $\approx 1\%$ aq. acetic acid, pH 3.4; spinneret: 300 μm , 10 hole)

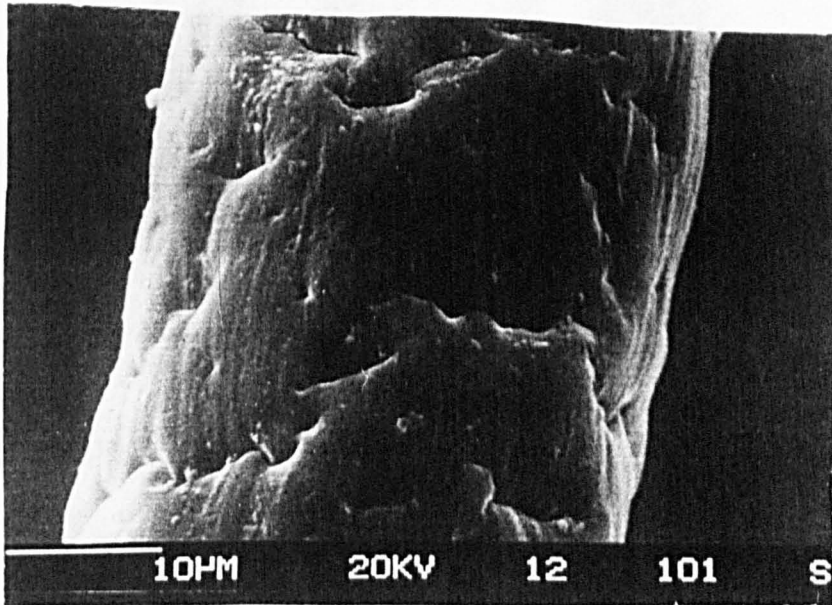

PLATE 3.6: Surface rupture in DJWS filament at jet stretch ratio of 6 (coagulant : $\approx 0.1\%$ aq. acetic acid, pH 3.4; spinneret: 300 μm , 10 hole)

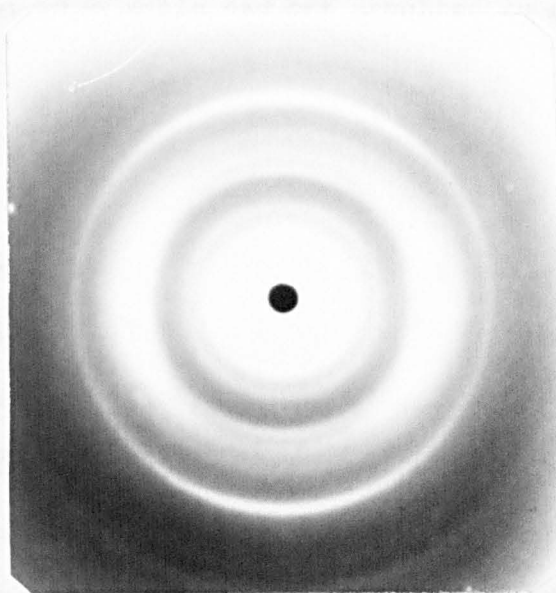

PLATE 3.7: X-ray diffraction patterns of undrawn DJWS fibres at jet stretch ratio of 0.85

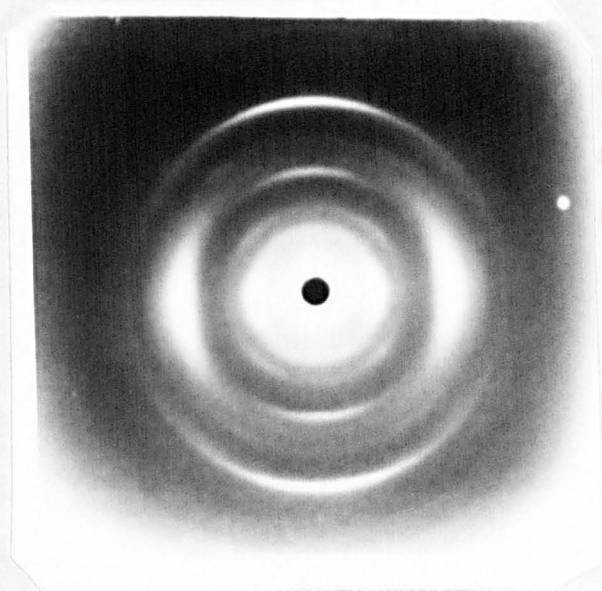

PLATE 3.8: X-ray diffraction patterns of undrawn DJWS fibres at jet stretch ratio 6

increasing jet stretch ratio had not resulted in any noticeable improvement in the wet strength of the fibres. In fact, it appeared that the wet properties became worse with increasing jet stretch ratio.

As for wet spinning, a maximum jet stretch ratio of 1.2 was obtained for the 150 μm , 10 hole spinneret used. Around this JSR (1.0-1.2) occasional fibre breakages occurred in the coagulation bath, and spinning above the ratio was impossible. Table 3.10 shows the results obtained using the same spinning conditions as described under Table 3.8. The results are similar to those obtained for dry-jet wet-spinning. While extensibility decreased with increasing jet stretch ratio, the tenacity increased to a maximum value around a jet stretch ratio of 0.85. The wet strength and extensibility, like those of the dry-jet wet-spun fibres, were poor and appeared to deteriorate with increasing jet stretch ratio.

3.2.4 Comparison of various coagulants using a typical wet spinning spinneret

So far, all the wet spinning done had been carried out with an 150 μm , 10 hole spinneret. In a typical wet spinning operation, the 150 μm hole diameter would be considered to be a little too large. It was therefore feared that the lack of improvement in fibre properties might have been due to this. For this reason, fibres were produced with an 80 μm , 20 hole spinneret, using different coagulants, some of which had already been introduced.

Table 3.11 shows the results obtained. As indicated in the table, it was not possible to spin using an acetone bath alone or in combination with DMA. Fibres produced were either too weak and could

TABLE 3.10: Effect of jet stretch ratio on the mechanical properties of undrawn wet spun fibres

Sample No.	Jet stretch ratio	Fibre diameter (μm)	Fibre count (dtex)	Tenacity, T (g/dtex)	Extensibility, E (%)	Tensile factor ($TE^{\frac{1}{2}}$)
3-52	0.65	66.4	47.5	0.95	40.5	6.05
3-53	0.85	52.0	28.8	1.13 (0.30)	32.5 (31.6)	6.44 (1.69)
3-54	1.20	46.8	24.3	1.11 (0.20)	22.4 (18.5)	5.30 (0.86)

() under wet conditions

Spinning conditions (3-52 to 3-54)

Spinneret 150 μm , 10 hole

Other conditions used were as described under Table 3.8 (for wet spinning)

TABLE 3.11: Comparison of the mechanical properties of wet spun fibres from various coagulants using an 80 μm , 20 hole spinneret

Sample No.	Coagulant	Fibre count (dtex)	Tenacity T (g/dtex)	Extensibility T (%)	Tensile factor ($\text{TE}^{\frac{1}{2}}$)	Fibre density (g/cm^3)
3-55	Methanol	8.3	1.20	20.9	5.49	1.389
3-56	DMA/water 75/25 v/v	7.8	1.14	15.0	4.42	1.389
3-57	Water	8.3	1.10	21.9	5.15	1.391
3-58	Water (pH 3.4)	8.5	1.12	20.0	5.01	1.389
3-59	Water (pH 10.6)	8.7	1.11	21.3	5.12	1.387
3-60	Acetone	Extrudates were very weak, strength too low to take-up even at very low take-up roller speeds. Attempts made to spin resulted in frequent breakages in the bath.				
3-61	Acetone/ DMA 90/10, v/v	Not possible to spin, breakage due to poor coagulation.				
3-62	Acetone/ DMA 50/50, v/v	Solution did not coagulate even after staying in bath for 10 min. (Slow coagulation after 30 min.)				

Spinning conditions (3-59 to 3-62)

Dope: 7% (w/w) chitin, 8% (w/w) LiCl
Dope temperature: 60°C
Jet stretch ratio: 0.85
Linear rate of extrusion: 29.8 m/min
Chitin: C2-2
Bath length: 30 cm

not be hauled-off without breakage, or the solution did not coagulate at all, especially from baths containing acetone/DMA. For the rest of the coagulants from which fibres were spun, the tenacity values obtained were very similar (except for those spun into the methanol bath) to the values obtained with the 150 μm spinneret at the same jet stretch ratio. The value obtained from the methanol bath was about 8% higher than the rest of the coagulants. On the other hand, the extensibility values of the fibres were almost the same for all the coagulants except DMA/water, 75/25, where the value was about 5% lower than the rest. In comparison with the 150 μm spinneret, fibres produced had lower extensibility values in each case. Fibres were dull except for those spun from DMA/water, 75/25. The surface features were similar to those of wet spun fibres previously described (Plate 3.1). Again, the fibres obtained appeared to be apparently voidless in each case. The table also shows the densities of the fibres measured in tetrachloroethylene and toluene as described in section 2.5.2. It is evident that the density of the fibres was almost the same for all the coagulants. Similar values were obtained for dry-jet wet-spun fibres. The average value of 1.39 g/cm^3 obtained was lower than the value of 1.46 g/cm^3 calculated by Carlström [42] on the basis of four acetyl glucosamine residues per unit cell, but only slightly higher than the value of $1.35\text{-}1.38 \text{ g/cm}^3$ determined by Noguchi et al for chitin fibres [90].

From these early studies, the following conclusions can be drawn about the spinning of chitin fibres.

(1) While it was not possible to produce fibres from solutions of the original chitin (due to difficulties in filtration and degassing) a pretreatment of the original chitin flakes in PTS/IP for even 30 min

made it possible to obtain spinnable solutions which were easily filtered and degassed.

(ii) Ageing of dope led to bubble-free dope, improved spinnability, increased dope viscosity and to a smaller extent improved fibre properties. Optimum results were obtained between 5 and 9 days of ageing.

(iii) Because fibres were spun using a wet spinning plant specially designed for the production of acrylic fibres, the process of spinning was based on the procedure used for wet spinning acrylic fibres from DMF or DMA. However, there were difficulties in obtaining satisfactory fibres that could be easily dried. Therefore, a wide variety of fibre collection procedures were used which are detailed in section 2.4.3 (procedures a-c). In all the cases, fibres were either collected in hank form (in which case they were dried in air or in an oven at 70-75°C) or wound onto a paper bobbin after drying on the chrome rollers. It was found that while it did not appear to matter whether the fibres were dried in air or in an oven, the manner in which they were held before drying greatly affected the extensibilities and to a lesser extent, the tenacities of the fibres. When dried on the chrome rollers (Table 3.7) or under their own weights in air by hanging (Table 3.3) or in an oven between any two sides of an open square frame (Tables 3.1 and 3.4), fibre extensibilities and diameters decreased while tenacities increased. Thus, drying under tension was, relatively, a stretching operation and was found to have a more pronounced effect on fibres spun into 75-83% DMA/water baths than those spun into 100% water or dilute acid or alkali, indicating that fibres from high DMA baths were more easily deformed. In fact, only such fibres were observed to possess lustre.

(iv) No matter the coagulants used, the fibres were found to be

heavily swollen and very difficult to dry even when washed in cold and/or hot water. However, fibres were not tacky on emerging from the coagulation baths (except those spun into baths containing high DMA content); no problem was encountered during winding on the advancing reels. But drying on the rollers was very difficult as the fibres tended to stick together during drying. For this reason, most of the fibres spun were dried in air or in an oven.

(v) However, it was found that washing arrangements involving methanol alone, or cold and/or hot water bath(s) followed by a methanol wash, produced fibres which were more easily dried. Generally, washing was found to be a very important part of the spinning operation. Fibres that were not washed at all were extremely weak but were much more extensible than those washed. Since the filaments were wrapped around the advancing reels several times before washing, it was presumed that the fibres were under tension during the washing operation, and this could be partly responsible for the fibre properties obtained.

(vi) Drawing of the fibres was found to be very difficult; drawing at 12% could be done but this resulted in frequent fibre breakages. The drawn fibres had higher tenacities than those undrawn, but were extremely brittle, most likely because of their low extensibilities.

(vii) It was found that spinning variables such as dope temperature or concentration had more or less no effect on the properties of the fibres.

(viii) Similarly, the fibre properties were not substantially influenced by the coagulation composition (Table 3.11), although as already indicated, fibres spun into 75-83% DMA baths were easily deformed under tension, causing differences in fibre properties.

(ix) Fibres spun using an 80 μm hole size had similar tenacity values with those obtained using 150 μm hole size, but lower extensibilities. However, fibres obtained from the former were quicker to dry especially when spun into methanol.

(x) The major differences between wet spinning and dry-jet wet-spinning observed was that fibres produced using the latter method could receive higher jet stretch ratios that varied between 0.85 and 6 with 300-400 μm spinneret hole size, and 0.85 and ~ 3 with 150 μm hole size. For wet spun fibres it was only possible to vary the ratio up to 1.2. Increase in jet stretch ratio had an effect similar to stretching as was observed (for DJWS fibres) from X-ray diffraction patterns, electron micrographs (fibrillar texture), increased value of tenacity with decreasing extensibility and high initial modulus. Furthermore, while wet spun fibres were dull (except when spun into high % DMA baths, and stretched) and had rough surfaces, DJWS fibres were lustrous and had smooth surfaces whatever the coagulant, especially those spun at low jet stretch ratios.

(xi) The fibre properties (Table 3.12) and stress-strain curves (Fig. 3.8) of some selected samples produced, varied depending on the conditions employed during the spinning process. Excepting the unwashed and drawn samples, the curves were characterised by a yield point of 2-3% extension. Those fibres drawn had very low extensibilities (7-9%) and tenacities (1.30-1.43 g/dtex). The effect of drawing appeared therefore to be more pronounced on fibre extensibilities. In all the cases examined, fibres produced by DJWS at high jet stretch ratios, had properties equivalent to drawn fibres. Such fibres could not withstand further stretching.

TABLE 3.12: Summary of the properties of some selected fibre samples produced by wet spinning and dry-jet wet-spinning in early spinning trials

Sample	Tenacity (g/dtex)	Extensibility (%)	Tensile factor (TE ^{1/2})	Initial modulus (g/dtex) ⁺
<u>Wet spun*</u>				
Unwashed	0.25	76.7	2.2	1.6
Washed and dried under tension in air or in an oven(70-75°C)	0.75-1.22	12-32	3.9-5.8	23.0
Washed and dried relaxed in air or in an oven (70-75°C)	0.68-1.12	32-51	4.7-7.2	16.0
Washed and dried under tension on the chrome rollers	1.18-1.23	16-20	4.7-5.5	26.0
Washed, drawn and dried under tension on the chrome rollers	1.40-1.43	7-9	3.7-4.3	35.0
<u>Dry-jet wet-spun**</u>				
Washed and dried relaxed in an oven (JSR 0.85)	0.94	34	5.5	16.3
Washed and dried relaxed in an oven (JSR 2.87)	1.52	20	6.9	44.2

+ At 2% strain

* Spinneret 150 µm, 10 hole

** Spinneret 300 µm, 10 hole

In each case, filaments, after coagulation, were passed around the second roller of the first pair of advancing reels with 15-20 turns before washing.

FIG. 3.8: Stress-strain curves of various chitin fibres produced by wet spinning and dry-jet wet-spinning in early spinning trials

Wet spun (150 μm), 10 hole)

- (1) Unwashed
- (3-26) Washed and dried relaxed in an oven
- (3-38) Washed and dried under tension on chrome rollers
- (3-40) Washed, drawn and dried under tension on chrome rollers

Dry-jet wet-spun (300 μm , 10 hole)

- (3-47) Washed and dried relaxed in an oven (JSR 0.85)
- (3-49) Washed and dried relaxed in an oven (JSR 2.87)

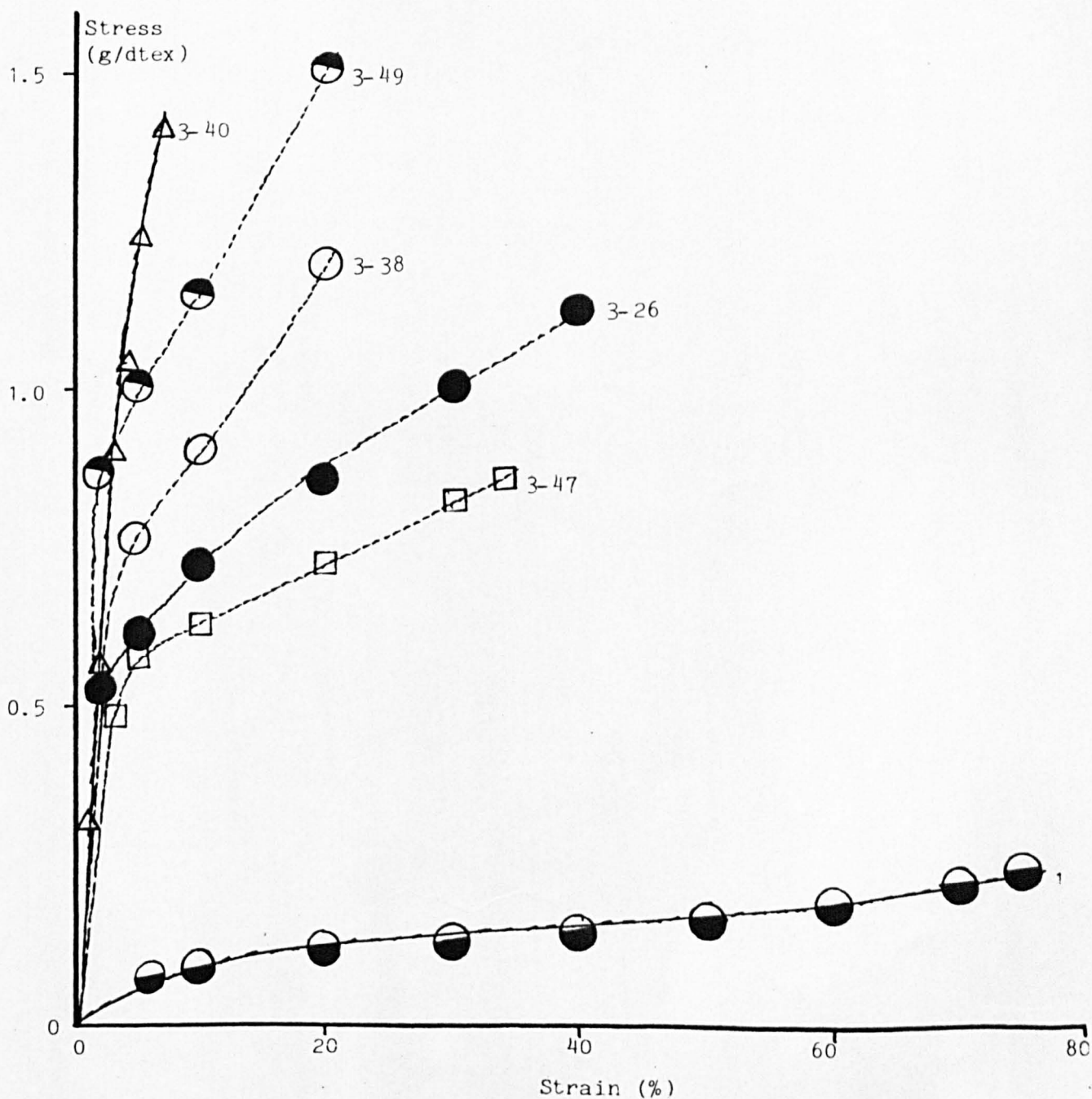

(xii) The different grades of chitin obtained from blue crab and hydrolysed, behaved similarly in spinning. It appeared also that fibres produced from them showed relatively no noticeable differences in properties.

CHAPTER 4

CHARACTERISATION OF CHITIN SAMPLES

4.1 Results and discussion

4.1.1 Examination of chitin solubility in different solvents

As was discussed in chapter 3, part of the initial problems encountered during the preliminary spinning trials was probably due to the difficulties observed in coagulation. Doubts were therefore expressed as to the choice of DMA-LiCl as the solvent for spinning. In addition a later published work by Kifune et al [97] supported even more the use of another solvent. This led to an examination of the solvents quoted in the literature for chitin.

The results of this examination showed that while it was observed that both chitins (treated and untreated) dissolved completely and rapidly in concentrated sulphuric acid and in dichloro- and trichloro-acetic acids (in combination with chloral hydrate and methylene chloride), they did so with degradation. But in HCl (12 N) complete solubility was not achieved, even after three weeks at room temperature, and as will be shown later, this did not prevent the degradation of the samples in the acid. However, Hackman [29] claims that if the chitins are first soaked in 1% dilute HCl for 4 h and then treated in 12 N HCl, rapid dissolution occurs. It was noticed that following the 1% HCl soaking, a large proportion of both chitins (treated and untreated) did indeed dissolve very rapidly within 30 minutes of vigorous stirring, leaving behind a second fraction (<25%) in each case which dissolved only after three weeks storage at room temperature. Organic acids such as formic acid (99%), highly concentrated solutions of lithium thiocyanate (20%-60%) and anhydrous trifluoroacetic acid were not able to dissolve either the treated or untreated chitin, even after leaving for six months at room temperature.

After this brief examination of possible alternative chitin solvents, it was decided to regard the DMA-LiCl system as the most appropriate solvent. It should be mentioned though that solubility of the untreated samples (C1, C2 and C3) in this system was not particularly good. After over 16 hours in 8% (w/w) LiCl-DMA, it was noticed that there were some insoluble particles in the solutions, which did not dissolve even after heating at 60-80°C for over 3 hours, while stirring vigorously with a magnetic stirrer. However, the percentage solubility obtained (60-65%) compared well with the 58% solubility obtained for similar chitins by Rutherford and Austin [57]. It was also noticed that below a certain LiCl concentration, the samples would not dissolve at all. Before any appreciable solubility was obtained, the LiCl was often in considerable molar excess to the N-acetylglucosamine units (NAG). It appeared that below a molar ratio of 2.4:1 (LiCl:NAG), no dissolution occurred. For example, a 2% (w/w) C1 or C2 or C3 sample appeared not to have been affected by DMA-1% (w/w) LiCl, but the same quantity became increasingly soluble as the LiCl concentration was increased to 10% (w/w) (saturation point). However, the mixtures formed were heterogeneous in each case and extremely difficult to filter, especially at concentrations above 2% (w/w) chitin, where the solutions became jelly-like and too viscous to flow. (Similar observations were reported by Mwakatole [134]. He observed that below 2% LiCl, chitin did not dissolve in DMA. When 2% chitin was taken and different amounts of LiCl added to it, at low concentrations (1-2.8% LiCl), no appreciable dissolution of chitin took place, but when the percentage of LiCl exceeded 3% a dramatic change in viscosity occurred as the chitin dissolved. Above 4% LiCl, solutions were said to become extremely viscous and jelly-like.) At concentrations

less than 2% chitin (made by mechanically stirring for more than 12 hours) it was possible to remove most of the insoluble particles through vacuum filtration using a sintered glass crucible (porosity 1). The method was, however, time consuming and only practicable for volumes less than 50 ml, as the crucible became blocked frequently with both gel and insoluble particles. An examination of the insoluble material showed that some of it existed in small swollen lumps throughout the solution which appeared to be partially dissolved, while other more particulate material did not appear to have been affected. These particles appeared like scales. These results suggested that there might be either some impurities still left in the samples, or that some of the chitins might be in a more crystalline state than the rest.

The degree of solubility of C1, C2 and C3 samples was, however, totally different after the treatment in TSA/IP. Solubility tests carried out on 0.5 g samples of C1-7 and C2-2 in DMA (100 ml)-8% LiCl showed 100% dissolution within 6 hours of stirring with a magnetic stirrer. While the maximum percentage by weight of C1, C2 and C3 samples that could be dissolved in DMA-8% LiCl was 3.5%, that of samples treated with TSA/IP was up to 10% by weight for samples treated for over 2 hours and about 9% for samples treated for 30 minutes. Details of this are given in section 5.4.2.

4.1.2 Dilute solution viscosity measurements

Table 4.1 and Fig. 4.1 show the results of the dilute solution viscosity measurements carried out on C2 samples in DMA-8% LiCl at 25°C. Table 4.2 shows similar experiments carried out on some of the treated samples for different treatment times for comparison. In Fig. 4.1, both

TABLE 4.1: Dilute solution viscosity measurements
for the C2 samples

Concentration $\times 10^{-2}$ (g/dl)	η_r	η_{sp}	η_{sp}/c	$\ln \eta_r$	$(\ln \eta_r)/c$
5.00	2.86	1.86	37.20	1.05	21.02
2.50	1.80	0.80	31.89	0.59	23.45
1.25	1.37	0.37	29.46	0.31	25.08
0.50	1.14	0.14	28.00	0.13	26.21

Solvent flow time (T_0) = 73 sec

$[\eta] = 27.0 \text{ dl g}^{-1}$

All solution viscosities measured in DMA-8% LiCl

FIG. 4.1: Dilute solution viscosity measurements of chitin in 8% (w/w) LiCl-DMA for C2 samples

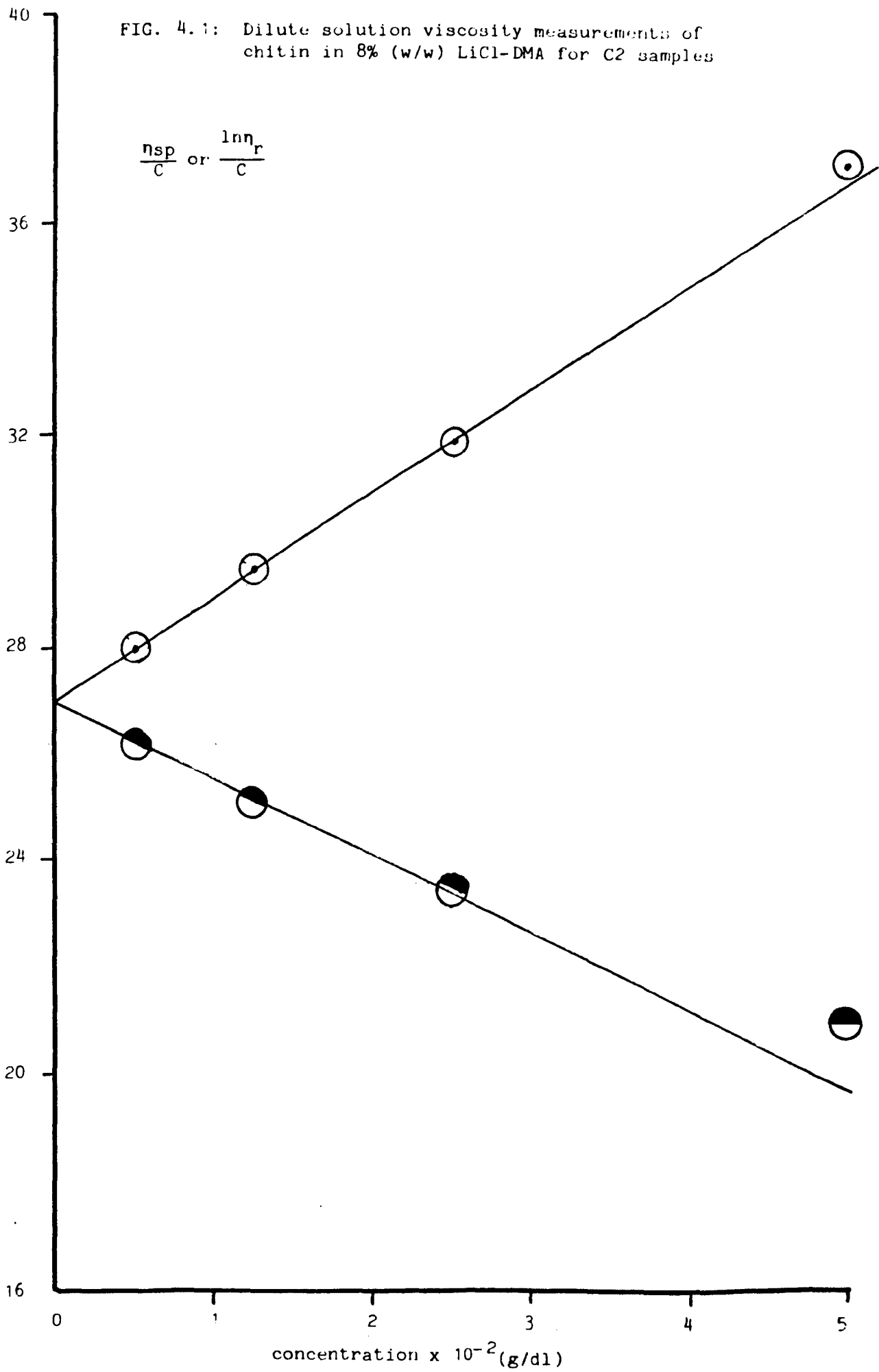

TABLE 4.2: Solution viscosity measurements of chitins treated with TSA/IP

Concentration (g/dl)	η_r	η_{sp}	η_{sp}/c	$\ln \eta_r$	$(\ln \eta_r)/c$
<u>C2-7 (treated for 7 hours)</u>					
0.500	4.623	3.623	7.246	1.531	3.060
0.250	2.515	1.515	5.710	0.922	3.689
0.125	1.611	0.611	4.887	0.477	3.815
<u>C2-7 (treated for 7 hours*)</u>					
0.500	4.875	3.875	7.750	1.584	3.168
0.250	2.476	1.476	5.904	0.907	3.626
0.125	1.613	0.613	4.904	0.478	3.825
<u>C3-0.5 (treated for 30 minutes)</u>					
0.250	2.729	1.729	6.918	1.004	4.016
0.125	1.728	0.728	5.821	0.547	4.376
0.063	1.335	0.335	5.317	0.289	4.586
<u>C3-2 (treated for 2 hours)</u>					
0.250	2.468	1.468	5.872	0.903	3.614
0.125	1.632	0.632	5.058	0.490	3.918
0.063	1.302	0.302	4.832	0.264	4.190
<u>C3-6 (treated for 6 hours)</u>					
0.250	2.360	1.360	5.440	0.859	3.435
0.125	1.598	0.598	4.785	0.469	3.750
0.063	1.291	0.291	4.619	0.255	4.054

* 100 g of chitin was treated instead of the usual 50 g

Solvent flow time (T_0) = 73 sec

$[\eta] = 4.10 - 4.75$ (see Table 4.3)

All solution viscosities measured in DMA -8% LiCl

the viscosity number, η_{sp}/c , and reduced natural logarithm of relative viscosity, $(\ln \eta_r)/c$, were plotted against concentration and the limiting viscosity number, $[\eta]$ was taken as the common ordinate intercept at which both straight lines met. The $[\eta]$ value for the untreated chitin (C2) was found to be 27 dl g^{-1} . Similar procedures were used for determining the $[\eta]$ values of the treated samples. From the value of $[\eta]$ for the C2 sample, a molecular weight of 2.04×10^6 was calculated by the use of equation 2.7. The same equation was used for calculating the molecular weights for the treated samples. It is clear from these results that the molecular weight of the original chitin was very high. Table 4.4 shows a comparison of the molecular weights of various chitins determined by different workers, and it can be seen that they are of similar magnitude to that measured for the C2 sample in this work. All the workers, except Hackman and Goldberg [135], used Lee's viscometric constants given in equation 2.7 for chitosan for the evaluation of the molecular weights. It is clear from these results that chitin generally is a very high molecular weight polymer and the size will almost certainly depend on the method of isolation and/or the source.

It is no wonder, given such a high molecular weight, that the original chitin was difficult to dissolve, and that such solutions as were obtained in DMA-LiCl contained undissolved material. On the other hand, C2 and C3 samples treated with TSA/IP had their molecular weights considerably reduced to an average of about 1.53×10^5 (see Table 4.3). With treated samples, very homogeneous solutions were obtained in DMA-LiCl. It appeared that a constant molecular weight was obtained after a treatment time of about 2 hours. An increase in the quantity of chitin treated

TABLE 4.3: Effect of time of treatment with TSA/IP on solution viscosity

Code	Time of treatment (h)	$[\eta]$ (dlg ⁻¹)	Molecular weight† $\bar{M}_w \times 10^{-5}$
C2-7	7.0	4.20	1.49
C2-7*	7.0	4.10	1.44
C3-0.5	0.5	4.75	1.77
C3-2	2.0	4.20	1.49
C3-6	6.0	4.10	1.44

* 100 g of chitin was treated instead of the usual 50 g

† Calculated using equation 2.7

TABLE 4.4: Average molecular weights (\bar{M}_w) of chitins

Source	Solvent	% Soluble material	$[\eta]$ (dl g^{-1})	\bar{M}_w ($\times 10^{-6}$)	Reference
Limulus	DMA-5% LiCl	82	25.6	1.8	57
Blue crab	"	58	23.0	1.6	"
Red crab	"	76	22.3	1.3	"
Dungeness crab	"	30	12.3	0.6	"
Pink shrimp	"	62	9.2	0.4	"
Brown shrimp	"	92	13.2	0.8	"
A	DMA-5% LiCl		40.0	3.5	80
B	"		36.0	3.1	"
C	"		32.0	2.6	"
D	"		24.0	1.8	"
Squid pen	Formic acid (anhy.)		31.7	2.5	79
Scilla serrata (crab)	Lithium thiocyanate*			1.0 ⁺	135
Blue crab	DMA-8% LiCl	65	27.0	2.0	Present work

A-D = Kuruma prawn, isolated through various methods:

A = EDTA/enzyme; B = HCl/enzyme; C = EDTA/NaOH; D = HCl/NaOH

+ \bar{M}_w determined using light scattering

* saturated at room temperature and brought to 95°C

from 50 to 100 g did not appear to have affected the results and though the results obtained for the two grades of chitin (C2 and C3) are similar, concentrated viscosity measurement (see section 4.7) indicated C2 to give slightly more viscous solutions than C3.

The considerable chain scission achieved by this treatment raised some suspicion that the chitin might be undergoing other chemical attack, for example deacetylation. The next few experiments were then carried out to establish the constitution of the treated samples.

4.1.3 Infrared spectroscopy

The first of these experiments was infrared spectroscopy, which has become one of the commonest and perhaps quickest ways of identifying chitin. Although there is some dispute over the fine features of the infrared spectrum, there is agreement about the five main absorption bands [33]. These are the bands at 3480 or 3485 cm^{-1} and 3445 or 3447 cm^{-1} (O-H stretching) which are extensively altered to the region near 2500 cm^{-1} on deuteration especially the band at 3485 cm^{-1} ; the band at 3100 cm^{-1} (or 3264 cm^{-1}) assigned by Pearson et al [46]) due to N-H stretching vibrations; the bands at 1652 or 1656 due to C=O stretching (amide 1 band) and that at 1619 or 1625 cm^{-1} due either to C=O or C=N stretching assigned by Pearson et al [46]. But, as suggested by Parker [33], the band at 1625 cm^{-1} is the real C=O stretching absorption, while that at 1656 cm^{-1} is due to bound water which can be removed on exposure to D_2O vapour. In any event, the aim of this experiment was to establish that the important chitin absorption bands could be identified in the spectrum. Fig. 4.2 shows the infrared spectrum of both untreated (C2) and treated (C2-2), and Fig. 4.3 shows some deuterated spectra of the

FIG. 4.2: Infrared spectra of untreated and treated chitin samples

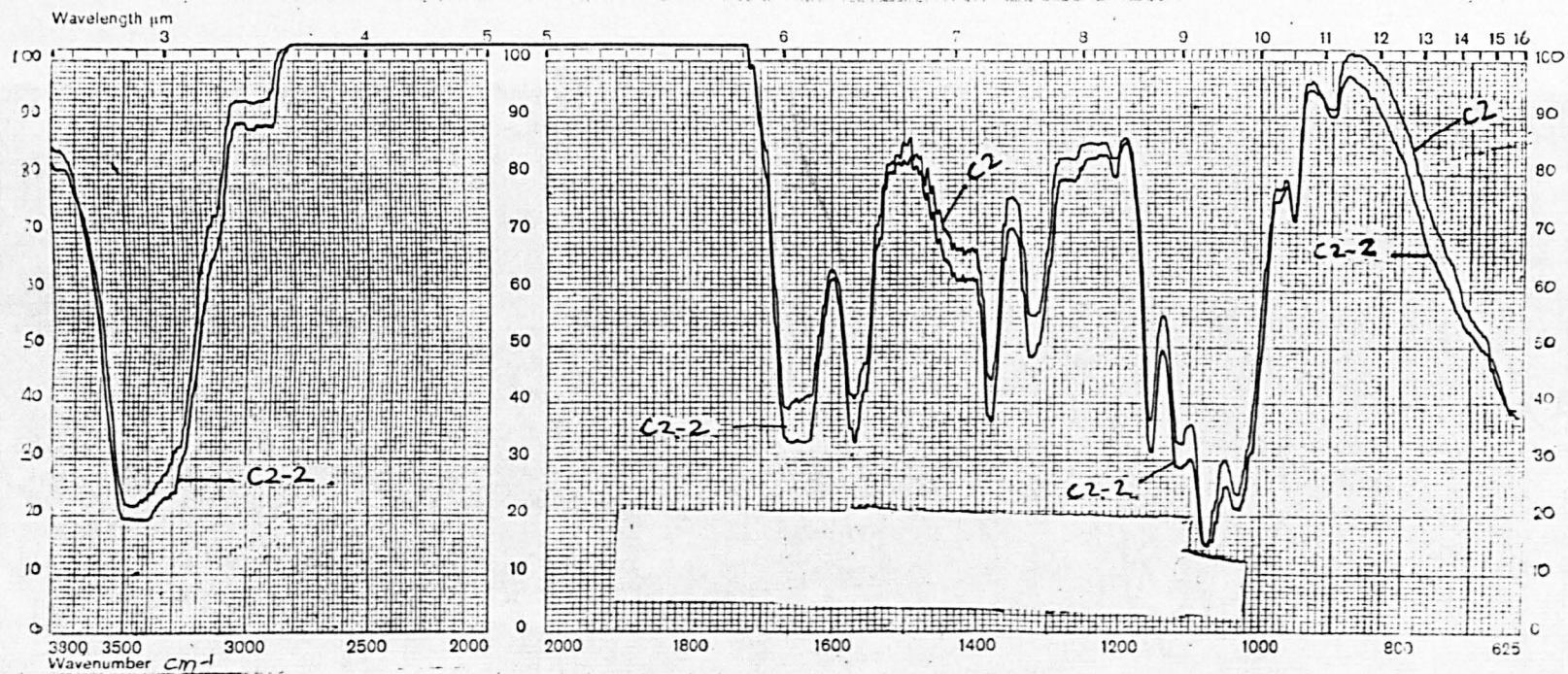
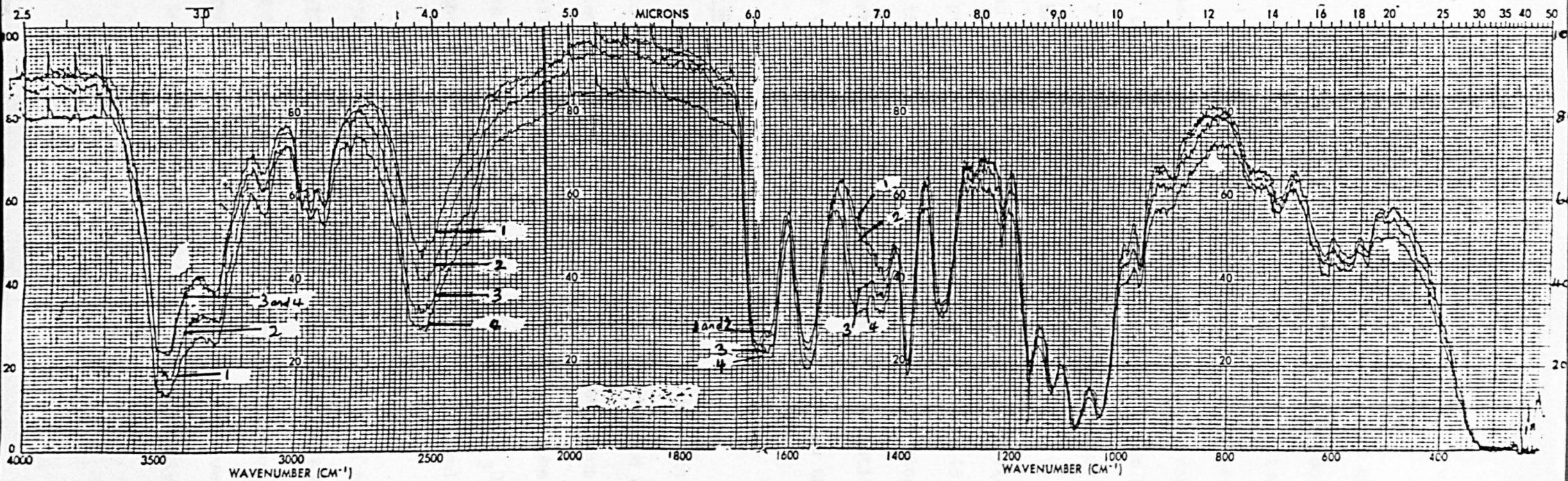

FIG. 4.3: The infrared spectra of treated chitin sample (C2-2) deuterated for different times

(1) 5 min; (2) 15 min; (3) 80 min; (4) 4.5 h in D_2O



C2-2 sample kindly produced by J. Moore of the Biophysics department, Leeds University. The spectra show all the fine absorption bands mentioned above including the bands at $1550\text{--}1570\text{ cm}^{-1}$ (amide 11 band) and $1310\text{--}1330\text{ cm}^{-1}$ (amide 111 band) which are characteristic of chitin [46]. Some of the bands in Fig. 4.2 were poorly resolved especially those in the 3200 cm^{-1} and 1600 cm^{-1} regions. These bands are more clearly shown in Fig. 4.3 for the C2-2 sample. From the prominence of these absorption bands, both C2 and C2-2 were considered to be similar to each other, and high in acetyl content. Highly deacetylated samples show weaker absorption bands at 1665 cm^{-1} , 1550 cm^{-1} and 1310 cm^{-1} [109,110]. Hence there was no evidence for excessive chemical modification occurring during the TSA/IP treatment. Quantitative determinations of the acetyl content were made to confirm this conclusion.

4.1.4 Elemental analysis and acetyl content values

Table 4.5 shows the elemental analysis, acetyl and N-acetyl glucosamine values for some selected treated and untreated chitin samples. Some of the samples were treated under different conditions from the usual TSA/IP treatment. Included also in the table are the values calculated for the pure N-acetylglucosamine residue ($\text{C}_8\text{H}_{13}\text{O}_5\text{N}$; molecular weight 203) and the glucosamine residue ($\text{C}_6\text{H}_{11}\text{O}_4\text{N}$; molecular weight 161).

A comparison of the observed C, H, N values with those for pure chitin was initially interpreted as indicating that all the samples had been deacetylated to some degree. Such variations were expected considering the general structure of chitin earlier reviewed (section 1.3). Chitin is thought of as composed of chains of mainly NAG

TABLE 4.5: Results of elemental and acetyl analyses for some selected treated and untreated chitin samples

Sample		C (%)	H (%)	N (%)	N/C	CH ₃ CO- (%)	% amide groups acetylated
Pure chitin(theory)		47.30	6.80	6.90	0.146	21.18	100
Pure chitosan (theory)		44.70	6.80	8.70	0.195	0.00	0.00
	C2	43.70	6.30	6.30	0.144	17.60	80.00
C2 treated with TSA/IP for different reaction times	C2-0.5	44.10	6.30	6.35	0.144	16.10	72.50
	C2-2	44.60	6.25	6.35	0.143	15.80	70.00
	C2-4	43.70	6.25	6.35	0.145	15.40	68.00
	C2-6	44.10	6.35	6.35	0.144	15.60	69.00
C2 samples given treatments as indicated	A	44.90	6.20	6.35	0.141		
	B	40.60	6.30	6.00	0.148		
	C	43.60	6.30	6.30	0.145		
	D	43.60	6.30	6.20	0.142		

A = Treated in 4% NaOH for 24 hours at room temperature

B = Treated in cold HCl (12 N) for 30 minutes

C = Chitin treated in cold acetic acid (98%) for 48 hours

D = Chitin treated in: Acetic acid (99.7%) for 30 minutes
HCl (2 N) for 2 hours
NaOH (1 N) at 80°C for 3 hours [97]

units interspersed by a few glucosamine units; in addition, it is claimed that water molecules are held as part of the structure. A mixture (in parts by weight) of 82.5% NAG, 12.5% glucosamine and 5% water had been suggested by Giles et al [31], but such a suggestion may only be applicable strictly to a particular chitin sample, as the ratio obviously could vary from sample to sample. Following up this suggestion, Giles et al concluded that one in every six or seven N-acetylglucosamine residues is deacetylated. Similarly, Rutherford and Austin [57] suggested that one in every five N-acetylglucosamine is deacetylated in their samples. From the values of the acetyl content for C2 and the treated samples, it was estimated that one in every six N-acetylglucosamine residues was deacetylated in C2 (water content 7.5%) whereas for the treated samples one in every three or four N-acetylglucosamine residues might have been deacetylated (water content 8.8%). In comparison with C2, the treated samples were 1.5-2.2% lower in acetyl content. The fall appeared to increase with increase in treatment time to a steady value of approximately 15.6% after 2 hours, although the differences were small. The results obtained for all the samples were comparable with those quoted in the literature. Rutherford and Austin [57], using similar methods of determination, obtained acetyl contents for various chitins of between 13.8 and 20.7%. A value of 15% was quoted for chitin from blue crab. Giles et al [31] examined extensively the elemental analyses of chitins obtained using various extraction methods. Their results indicated an acetyl value of 17.2% for the only sample whose acetyl content was reported. They also reported a value of 20.47% presumably determined by Meyer and Wehrli [31]. Differences in acetyl content were ascribed to either differences in isolation method or

chitin source.

The ratio of nitrogen/carbon has been used by some authors [79,136] as an indication of the variability in the NAG content of chitin samples and these ratios are also given in Table 4.5. The results obtained not only indicate close similarity between the treated and the untreated samples but also that the ratios for all the samples were about 1.0% less than the ideal ratio of 0.146. The explanation normally given for ratios higher than 0.146 is occurrence of deacetylation (due mainly to the increase in nitrogen content) whereas lower values are an indication of removal of some amine groups or the presence of impurities in the chitin [57]. The treatment in 12 N HCl (sample B) appeared to have resulted in considerable modification of the chitin, since quite significant falls in both %C and %N were observed. Further purification of the C2 sample in 4% NaOH, apart from the extra whiteness produced, appeared to have increased the carbon content of the sample (sample B). Samples C and D were produced in an attempt to examine a procedure claimed to increase the acetyl content of chitin samples [97]. Although it was not possible to determine the acetyl content for all of the samples examined, due to lack of time, in the case of samples C and D, it was presumed that any increase in acetyl content would be expected to lead to an increase in the carbon content of the samples. However, as can be seen from the results obtained, no significant difference was observed in the elemental proportions from those of sample C2, the original sample. Acetylation of chitin requires more severe treatments [75].

Although it was earlier suggested that some degree of deacetylation occurred in all the samples, including C2, several possible

mixtures of poly-N-acetylglucosamine and water were considered to find the best agreement with the measured elemental analyses; it was found that on assuming one molecule of water per N-acetylglucosamine residue, a theoretical elemental analyses comparable with the data for carbon, hydrogen and nitrogen shown in Table 4.5, was found. (Calculated for $C_8H_{13}NO_5 \cdot H_2O$; C 43.44; H 6.79; N 6.33.) Furthermore, one molecule of water per N-acetylglucosamine residue corresponds to about 8.2% water which compares well with the amount of water in the samples (see section 4.1.6). It is not clear why such good agreement was obtained even when the third component of the mixture, glucosamine units, were not considered as part of the structure. When the possible mixture (for C2) of 80% N-acetylglucosamine, 12.5% glucosamine units and 7.5% water was considered, the following theoretical elemental analysis was found: C 43.4; H 6.0(3); N 6.6. This gave a N/C ratio of 0.152, which was considerably higher than the experimental values, indicating perhaps that the degree of deacetylation may in fact be less than what was earlier suggested. Similar conclusions were drawn for the treated samples.

It should be mentioned that the boundary between chitin and chitosan is not well established, but it is known that chitins do not dissolve in dilute acids such as acetic acid (1.3%). On the other hand, chitosan dissolves in dilute acids but not in DMA-LiCl. All the treated samples prepared were not soluble in either concentrated or dilute acetic or formic acids. Moreover, acetyl values for chitin as low as 13.8% have been quoted in the literature [57], and no indication was given that such samples could dissolve in dilute acids. It seems, therefore, clear that all the samples examined in this study are properly termed chitin.

4.1.5 Optical activity

From early observations of the viscosities of chitin dopes made from treated or untreated samples, it was noted that the viscosities of the solutions changed when monitored over a period of two weeks. Such observations of changes in chitin solutions were not new as similar changes in the optical rotation of chitin solutions during storage had been observed by Irvine [24] and Rutherford and Austin [57]. It was therefore decided to measure the optical activity of dilute solutions of some of the samples. The results obtained are shown in Table 4.6 for an untreated sample (C2) and a treated sample (C2-2). It was presumed however that the errors were large as the transition between the two highly bright positions which was used as the 'zero' position, was not clearly observed. Initially, the blurred appearance of this grey position was believed to be due to the high concentration of the solutions, but the same problem persisted with very low concentrations (eg. 0.5 g/100 ml, C2-2). The problem was only slightly reduced when, for example, the untreated chitin (C2) was pretreated in 4% NaOH overnight and the solutions obtained centrifuged for 30 minutes at 26,000 rpm. Indeed, all the solutions, including those from treated samples, were centrifuged before use. Nevertheless, the results appear to indicate that the optical activity of the treated and untreated samples was similar. No conclusion could be drawn as to whether the observed optical activity was changing with time. The results were different from those of Rutherford and Austin [57] who reported a wide range of optical activities for chitins from different sources. Their results varied from $(\alpha)_D^{25} = -56^\circ$ for Limulus chitin to $+75^\circ$ for that from pink shrimp. In another separate report [95] it was observed that, excepting chitin from Limulus

TABLE 4.6: Optical activity of chitin samples

Time (day)	Angular rotation		Observed rotation θ (deg)	Specific rotation [α] (deg)	Angular rotation		Observed rotation θ (deg)	Specific rotation [α] (deg)
	without sample (deg)	with sample (deg)			without sample (deg)	with sample (deg)		
1*	179.25	185.70	+6.45	64.5				
	<u>Untreated sample (C2)</u>				<u>Treated sample (C2-2)</u>			
1	179.26	178.94	-0.32	-95	179.24	177.76	-1.18	-118
2					179.25	178.21	-1.04	-104
3					179.25	178.40	-0.85	-85
4	179.34	178.96	-0.38	-110				
5					179.30	178.10	-1.20	-120
12	179.30	178.97	-0.33	-96				
17	179.32	178.95	-0.37	-108				
21	179.32	178.96	-0.36	-105				

* sucrose from sugar cane (Analar) supplied by BDH Chemicals Ltd. (concentration: 10 g/100 ml water)
 Treated sample was obtained after 2 hours reaction with TSA/IP (concentration: 1 g/100 ml DMA-8% LiCl)
 Untreated sample (C2) was pretreated in 4% NaOH overnight (concentration: 0.343 g/100 ml DMA-8% LiCl)

and brown shrimp which had the natural levo(-) optical rotation, most chitins from other sources had initially dextro(+) optical rotation due (it is claimed) to the severity of the extraction and purification methods used; but they became gradually converted to the natural levorotatory form after two weeks storage. It was claimed that the natural form (levorotatory) is more suitable for fibre formation and biological activity such as wound healing acceleration than the dextrorotatory form [57,95].

4.1.6 Thermal analysis

To obtain a rapid assessment of the moisture content of the chitin samples, TGA was investigated. The overall thermal stability of the chitin samples was also incidentally observed. Figure 4.4 shows the TGA for two of the untreated samples (C1 and C3) and a treated sample (C2-2). The treated sample had been reacted with TSA/IP for 2 hours. The main features of the TGA curves are the three regions where there are significant weight losses. The first weight change was interpreted as water loss corresponding to a moisture content of 7.5% for C1, 6.8% for C3 and 8.8% for C2-2, based on the original weight of chitin. Water loss took place between 25°C and 193°C for C1, 25°C and 156°C for C3, and 25°C and 132°C for the treated sample. The treated sample was therefore more easily dried. It was, indeed, noticed that drying at 100°C for over 30 minutes led to discoloration of the treated sample but not the untreated.

The other two regions of weight loss were the regions of decompositions. The major thermal decomposition took place between 288 and 425°C for C1, 270 and 408°C for C3, and 277 and 420°C for the treated

FIG. 4.4: Typical TGA curves of untreated and treated chitins

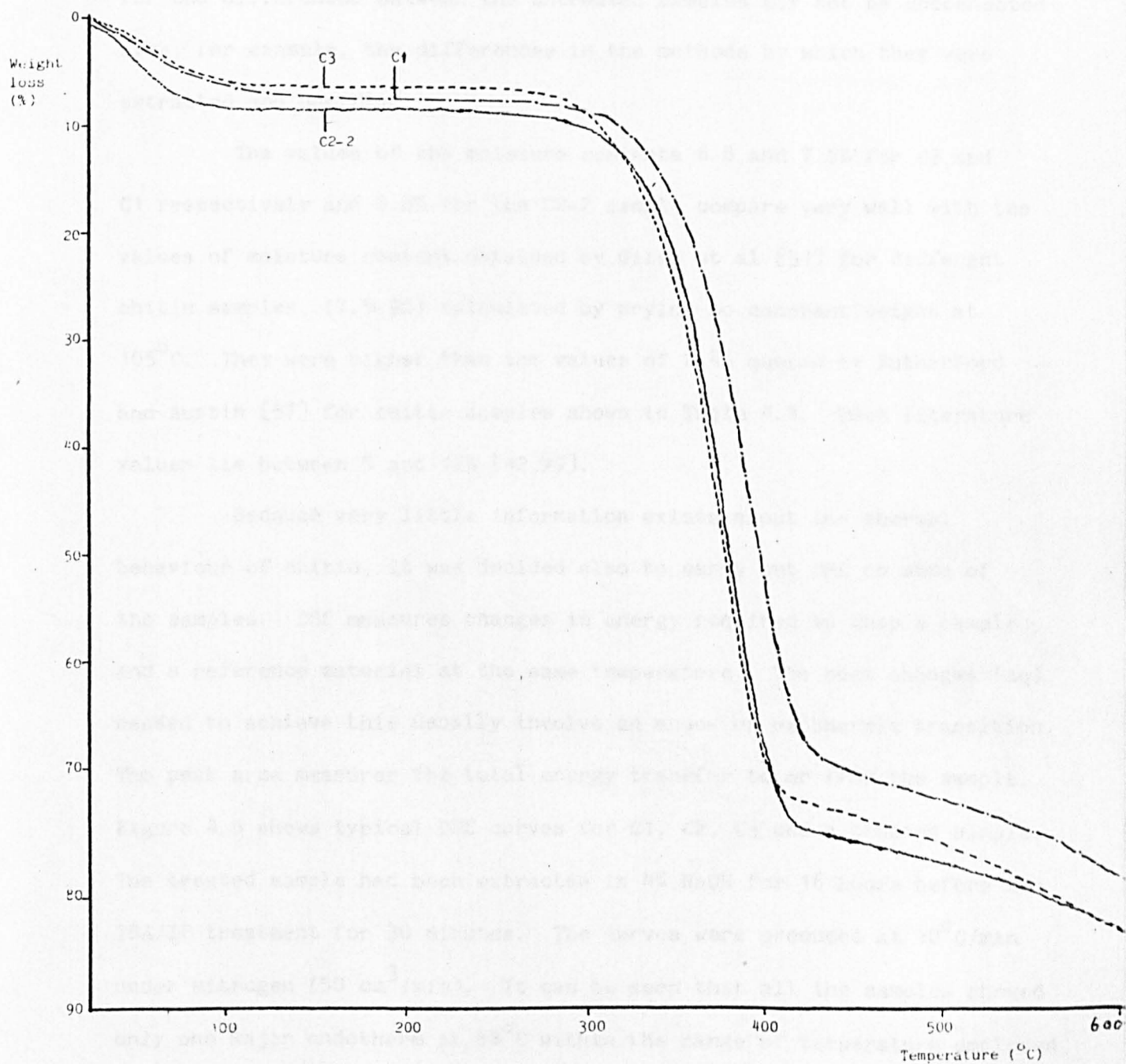

sample. From these results it appears that the treated sample was slightly less resistant to heat than C1, but appeared to be more resistant than C3. The differences, however, were small. The reason for the differences between the untreated samples may not be unconnected with, for example, the differences in the methods by which they were extracted and purified.

The values of the moisture contents 6.8 and 7.5% for C3 and C1 respectively and 8.8% for the C2-2 sample compare very well with the values of moisture content obtained by Giles et al [31] for different chitin samples, (7.5-9%) calculated by drying to constant weight at 105°C. They were higher than the values of 2-4% quoted by Rutherford and Austin [57] for chitin samples shown in Table 4.4. Most literature values lie between 5 and 12% [42,79].

Because very little information exists about the thermal behaviour of chitin, it was decided also to carry out DSC on some of the samples. DSC measures changes in energy required to keep a sample and a reference material at the same temperature. The heat changes (Δq) needed to achieve this usually involve an endo- or exothermic transition. The peak area measures the total energy transfer to or from the sample. Figure 4.5 shows typical DSC curves for C1, C2, C3 and a treated sample. The treated sample had been extracted in 4% NaOH for 16 hours before the TSA/IP treatment for 30 minutes. The curves were produced at 10°C/min under nitrogen (50 cm³/min). It can be seen that all the samples showed only one major endotherm at 88°C within the range of temperature employed (25-375°C). As already observed in the TGA curves, changes that occur in this temperature region are mostly due to loss of water. It, therefore, does not appear that there were significant differences between the

FIG. 4.5: Typical DSC curves of untreated and treated chitin samples

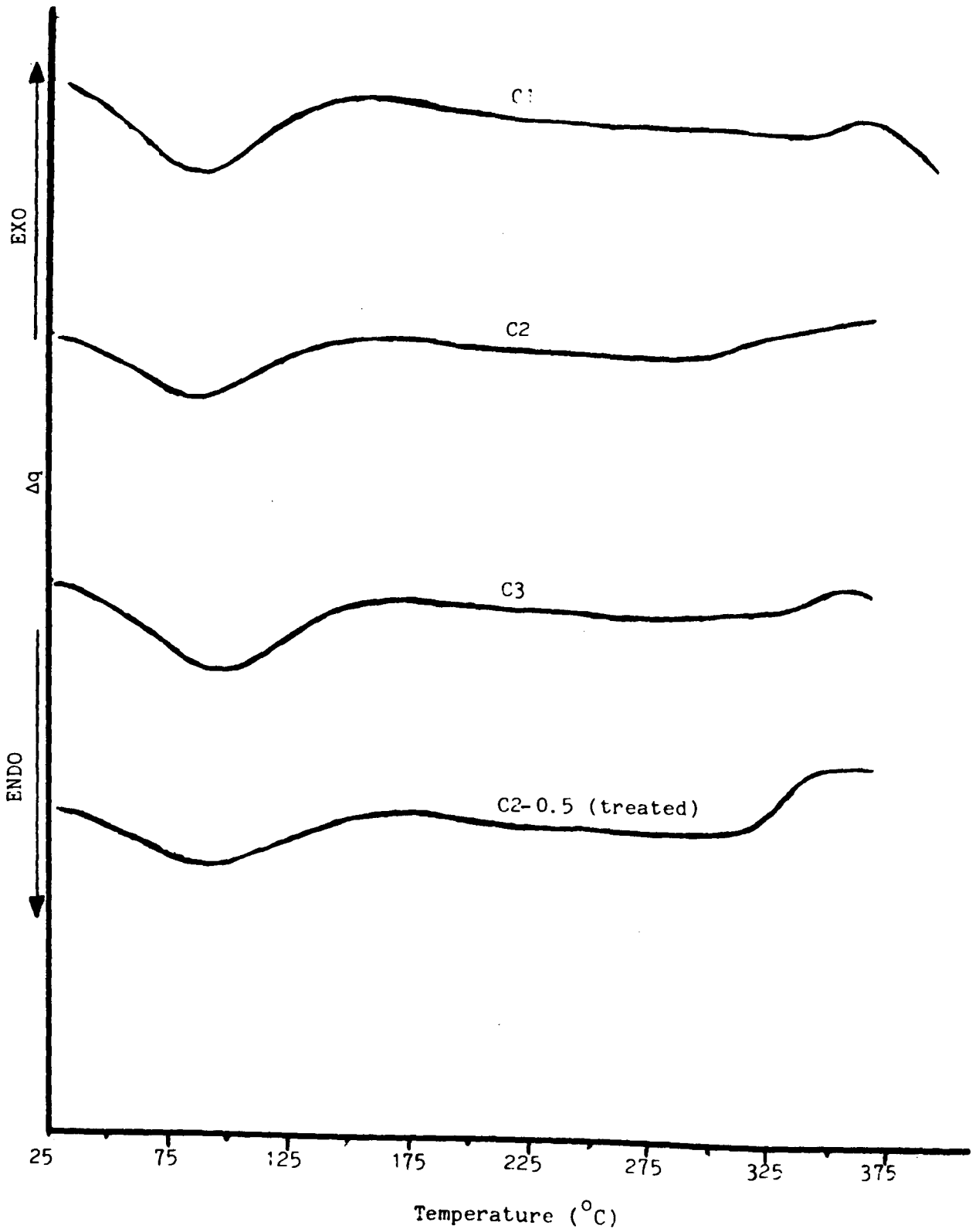

DSC traces of treated and the untreated samples, although a small endothermic transition which appears more clearly in the treated sample, can be seen between 275 and 330°C.

4.1.7 Viscosity of concentrated solutions of chitin

So far it has been shown through infrared spectroscopy, thermal stability, elemental analysis, acetyl content and optical activity, that the constitution of chitin samples treated in TSA/IP was similar to that of the original samples (C1, C2 and C3). It was also shown that by this treatment, the molecular weights of the treated chitin samples were lower than the original chitin by factors between about 11 and 14. This remarkable drop in the molecular weight as earlier mentioned led to complete solubility in DMA-LiCl which was otherwise impossible. In this section, attempts were made to investigate the effect of treating chitin in TSA/IP by viscosity measurement.

When polymer solutions are forced to flow by shearing force, they experience a viscous resistance (η) expressed as the ratio between the shear stress (τ) and shear rate (D), (eq. 4.1).

$$\eta = \frac{\tau}{D} \quad (4.1)$$

Various types of fluids are classified according to the plot of shear stress versus shear rate on either arithmetic or logarithmic coordinates. If η is independent of the shear rate as in eg. honey and water, the fluid is said to show Newtonian flow behaviour, but many fluids deviate from this flow pattern, with either decreasing or increasing η and are called non-Newtonian fluids. When viscosity decreases with increasing

shear rate as in polymer solutions or melts (except at very low shear rates), the fluid is described as pseudoplastic or possessing shear thinning behaviour. However, by contrast, the viscosities of such fluids as slurries and suspensions of solids increase with increasing shear rate. Such fluids are called dilatant, or shear thickening. It is believed that the non-Newtonian behaviour observed in polymer solutions and melts arises because under shear, the asymmetric molecules or particles previously entangled or randomly oriented become oriented with reducing points of entanglement; and where highly solvated molecules are present, the solvated layers may be sheared resulting in decreased interaction and consequently a decrease in viscosity [137].

Among the equations proposed for the analysis of flow problems, the most useful is the power law equation (eq. 4.2)

$$\tau = k(D)^n \quad (4.2)$$

where k and n are constants. This means that if the log of shear stress is plotted against log shear rate, the flow curve will fall on a straight line. However, most pseudoplastic fluids do not obey the law over a wide range as n tends to decrease with rate of shear. The quantity ' n ' is called the flow index and is used as a measure of the non-Newtonian nature of the fluid. For Newtonian fluids $n = 1$; pseudoplastics $n < 1$ and dilatant materials $n > 1$. The value of ' n ' is normally obtained by combining equations 4.1 and 4.2 which simplifies to

$$\eta = \eta_1(D)^{n-1} \quad (4.3)$$

where η_1 is the apparent viscosity at a shear rate of 1 sec^{-1} and η is the apparent viscosity at some shear rate (D).

Solutions of high polymers in general resist shearing due to chain entanglements, and the magnitude of such internal resistance (viscosity) depends on such molecular parameters as the chemical structure of the polymer, the molecular weight, molecular weight distribution and the degree of long-chain branching of the polymer [138-141]. However, as earlier indicated, as the shear rate increases, the internal resistances are being broken and the dope (or melt) viscosity begins to fall. At low shear rates, the viscosity (η_0) for most linear polymers is independent of shear rate.

Table 4.7 shows the viscosities at various shear rates between 0.9 and 455.7 s^{-1} for 2% untreated (C1, C2, C3 and A) and treated chitin samples (C2 and C3 treated in TSA/IP for 2 hours) dissolved in DMA-8% LiCl. Table 4.8 shows similar results for a 1% chitin solution (C2) dissolved in DMA-8% LiCl and also for a 20% acrylic (matt Courtelle) dope in DMF, both included for comparison. The values of N and S for all the results were read direct from the viscometer and were used as outlined in section 2.2.9 to determine τ , D and η values. Figure 4.6 shows the log-log plots of viscosity versus shear rate for all the solutions mentioned above, while Fig. 4.7 shows the log-log plots of viscosity versus shear stress for some selected solutions. Figure 4.8 shows the log of shear stress versus log of shear rate (flow curves) also for some selected solutions.

Figure 4.6 shows that all the solutions examined showed non-Newtonian or shear thinning behaviour, with the viscosity falling as the shear rate increased. However, for the acrylic dope solution, the deviations from Newtonian flow were relatively low and was observed above a shear rate of 14 sec^{-1} (flow index $n \approx 0.95$). Below this shear

TABLE 4.7: Dependence of viscosity (η) on shear rate (D) for chitin samples in DMA-8% (w/w) LiCl at 25°C

concentration: 2% (w/w) chitin

Code	N	1	2	4	8	16	32	64	128	256	512
	D	0.9	1.8	3.6	7.1	14.2	28.5	57.0	113.9	227.8	455.7
	log D	-0.051	0.250	0.551	0.852	1.154	1.455	1.756	2.057	2.358	2.659
C1	S	11	14	18	22	24	25	26	27	30	31
	τ	122.70	156.20	200.80	245.50	267.80	278.90	290.10	301.20	334.70	345.90
	log τ	2.089	2.194	2.303	2.390	2.428	2.445	2.463	2.479	2.525	2.539
	η	136.30	86.80	55.80	34.60	18.90	9.80	5.10	2.60	1.50	0.80
	log η	2.134	1.939	1.747	1.539	1.276	0.991	0.708	0.415	0.176	-0.097
C2	S	11	13	17	22	23	24	25	26	28	30
	τ	122.70	145.00	189.70	245.50	256.60	267.80	278.90	290.10	312.40	334.70
	log τ	2.089	2.161	2.278	2.390	2.409	2.428	2.445	2.463	2.495	2.525
	η	136.30	80.60	52.70	34.60	18.10	9.40	4.90	2.50	1.40	0.70
	log η	2.134	1.906	1.722	1.539	1.258	0.973	0.690	0.398	0.146	-0.155
C3	S	8	10	13	14	16	17	19	21	23	25
	τ	89.30	111.60	145.00	156.20	178.50	189.70	212.00	234.30	256.60	278.90
	log τ	1.951	2.048	2.161	2.194	2.252	2.278	2.326	2.370	2.409	2.445
	η	99.20	62.00	40.30	22.00	12.60	6.70	3.70	2.10	1.10	0.60
	log η	1.997	1.792	1.605	1.342	1.100	0.826	0.568	0.322	0.041	-0.213
A	S	9	11	14	18	20	22	23	24	26	29
	τ	100.40	122.70	156.20	200.80	223.10	245.50	256.60	267.80	290.10	323.60
	log τ	2.002	2.089	2.194	2.303	2.348	2.390	2.409	2.428	2.463	2.510
	η	111.60	68.20	43.40	28.30	15.70	8.60	4.50	2.40	1.30	0.710
	log η	2.048	1.834	1.637	1.452	1.196	0.934	0.653	0.371	0.114	-0.149
Treated in TSA/IP for 2 hours											
Concentration: 4%(w/w) chitin											
C2-2	S	(0)	(0)	(1)	(3)	6	12	23	40	62	80
	τ			(11.20)	(33.50)	66.90	133.90	256.60	446.30	691.70	892.60
	log τ			1.049	1.525	1.825	2.127	2.409	2.650	2.840	2.951
	η			3.10	4.70	4.70	4.70	4.50	3.90	3.00	2.00
	log η			0.491	0.672	0.672	0.672	0.653	0.591	0.477	0.301
C3-2	S	(0)	(0)	(1)	(2)	(4)	9	17	31	51	75
	τ			11.2	22.30	44.60	100.40	189.70	345.90	569.00	836.80
	log τ			1.049	1.348	1.649	2.00	2.278	2.539	2.755	2.923
	η			3.10	3.10	3.10	3.50	3.30	3.00	2.50	1.80
	log η			0.491	0.491	0.491	0.544	0.518	0.477	0.398	0.255

1 poise = 10^{-1} Pas

N = actual speed of the rotor (rpm)

D = shear rate (s^{-1})

S = scale reading

τ = shear stress (Pa)

η = viscosity (Pas)

() = For values less than 5; errors are presumed to be large

A = C2 treated in 4% NaOH for 24 hours at room temperature (2% solution)

TABLE 4.8: Dependence of viscosity (η) on shear rate (D) for 20% acrylic (matt Courtelle) in DMF and 1% chitin solution (C2) in DMA-8% LiCl at 25°C

	1	2	4	8	16	32	64	128	256	512
<u>20% acrylic dope</u>										
S	(1)	(2)	(4)	8	15	29	56	108	204	392.5
τ	11.20	22.30	44.60	89.30	167.40	323.60	624.80	1205.30	2276.10	4379.10
$\log \tau$	1.048	1.349	1.650	1.950	2.220	2.510	2.796	3.081	3.357	3.641
η	12.50	12.50	12.50	12.50	11.80	11.40	11.00	10.60	10.00	9.60
$\log \eta$	1.097	1.097	1.097	1.097	1.072	1.057	1.041	1.025	1.000	0.982
<u>1% chitin solution (C2)</u>										
S	(0)	(1)	(2)	(3)	(3)	(4)	5	6	8	9
τ		11.20	22.30	33.50	33.50	44.60	55.80	66.90	89.30	100.40
$\log \tau$		1.048	1.349	1.525	1.525	1.650	1.747	1.826	1.951	2.002
η		6.30	6.30	4.70	2.40	1.60	1.00	0.60	0.40	0.20
$\log \eta$		0.800	0.800	0.672	0.380	0.204	0	-0.222	-0.398	-0.700

FIG. 4.6; Dependence of the viscosity (η) of chitin solutions on shear rate (D) at 25°C

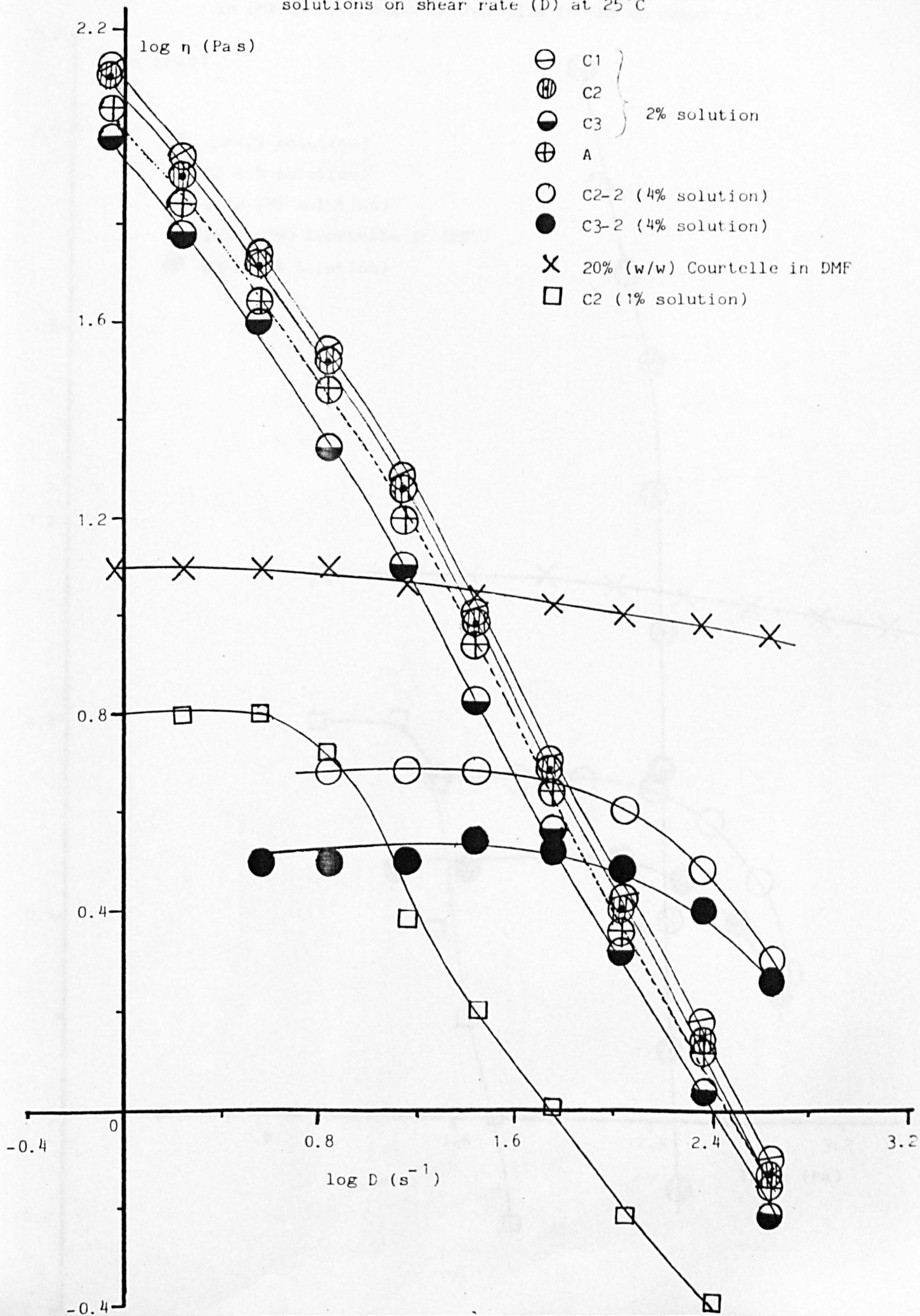

FIG. 4.7: Dependence of viscosity (η) of chitin solutions in DMA-8% LiCl and 20% Courtelle in DMF on shear rate

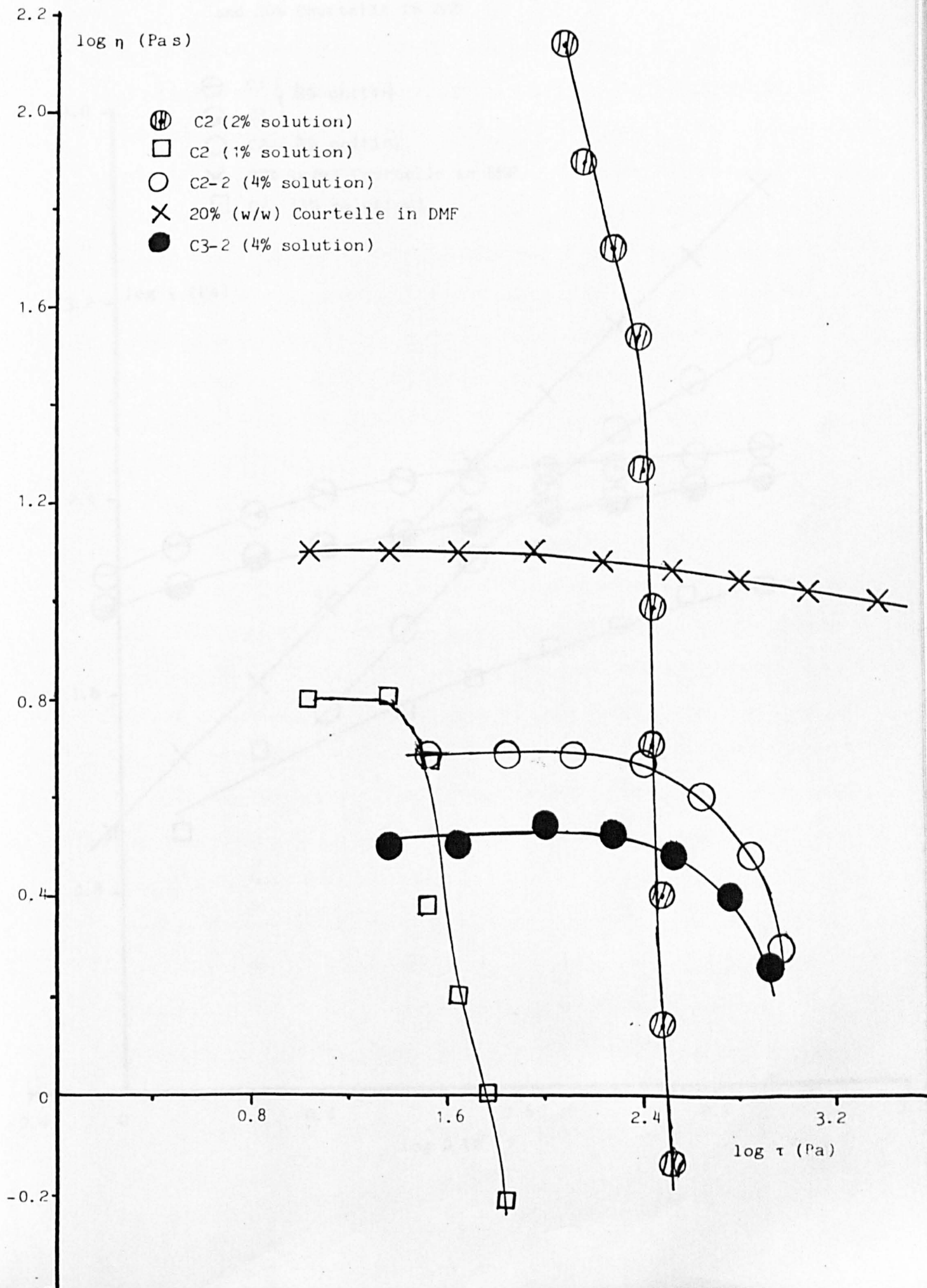
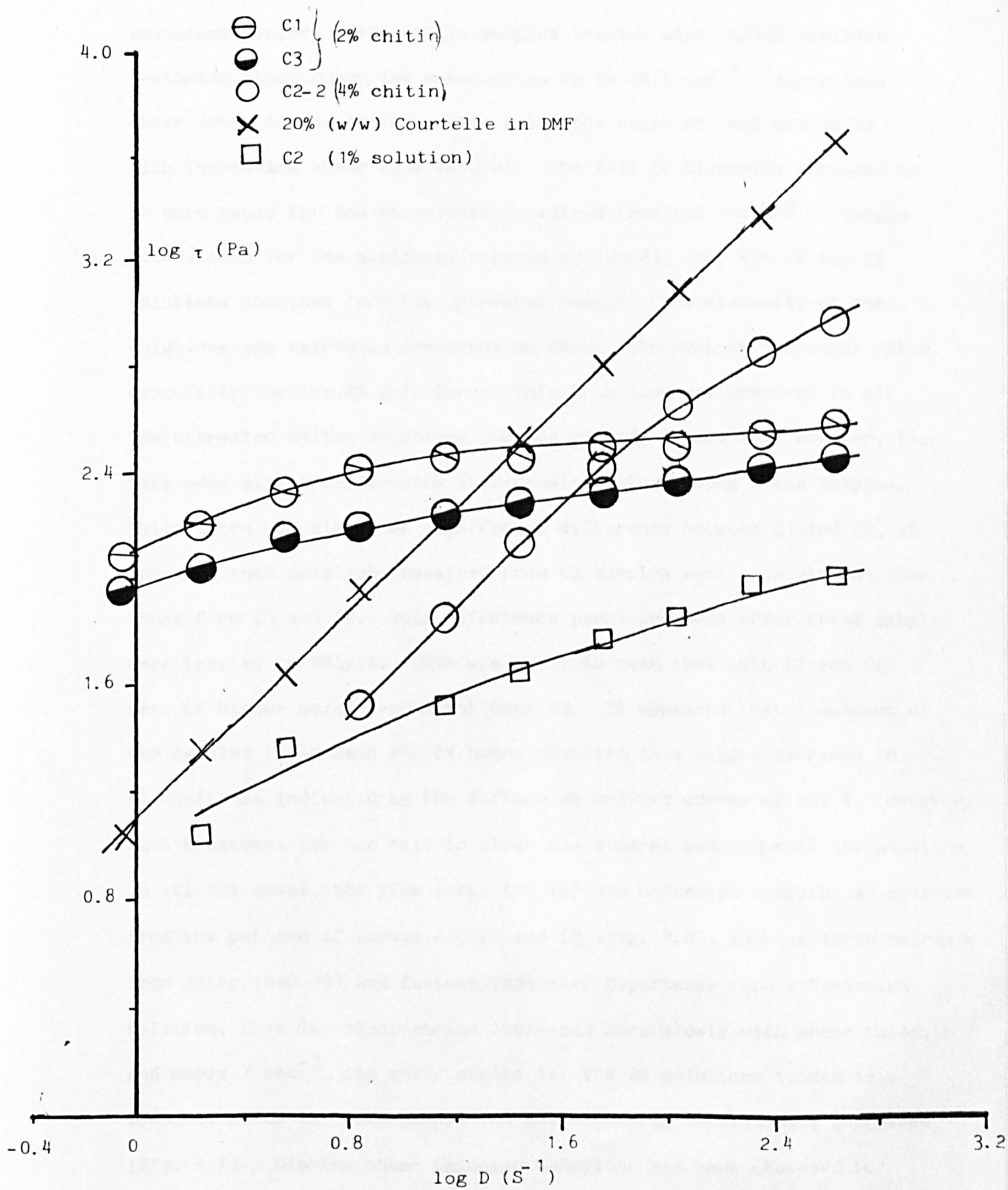

FIG. 4.8: Flow curves of chitin samples in DMA-8% LiCl and 20% Courtelles in DMF



rate the solution exhibited Newtonian behaviour ($n=1$). Similarly, solutions prepared from chitin samples treated with TSA/IP exhibited Newtonian behaviour at low shear rates up to 28.5 sec^{-1} . Above this shear rate, the viscosity of the solutions began to fall gradually with increasing shear rate ($n \approx 0.8$). The fall in viscosity appeared to be more rapid for the 4% solution obtained from the treated C2 sample (C2-2) than for the similarly treated C3 (C3-2). For the 1% and 2% solutions obtained from the untreated samples, the viscosity of the solutions was extremely dependent on shear rate even at low shear rates, especially for the 2% solutions. This behaviour was observed in all the untreated chitin solutions (curves C1, C2, C3 and A). However, there were some slight differences in viscosity values among these samples. While there was almost no significant difference between C1 and C2, it appeared that solutions obtained from C3 samples were less viscous than those from C1 and C2. This difference persisted even after these samples were treated in TSA/IP. This was taken to mean that both C1 and C2 were of higher molecular weight than C3. It appeared that treatment of the samples in 4% NaOH for 24 hours resulted in a slight decrease in viscosity as indicated by the difference between curves C2 and A. However, such treatment was too mild to alter the general behaviour of the solution. In all the cases, the flow index (n) for the untreated samples, as observed from the pattern of curves C1, C2 and C3 (Fig. 4.8), shows a large decrease from unity ($n \approx 0.33$) and further indicated departures from a Newtonian relation, that is, shear stress increased more slowly with shear rates, and above 7 sec^{-1} , the shear stress for the 2% solutions tended to a constant value for each sample and the viscosity continuously decreased (Fig. 4.7). Similar shear thinning behaviour had been observed for

untreated 2% brown shrimp chitin (Hercules KY-10) DMA/3.2% LiCl by Mwakatole [134]. The reason for the non-Newtonian behaviour as soon as the solutions were sheared is not clear, but it is known that the onset of non-Newtonian behaviour in polymer solution (defined by critical shear stress τ_{crit} or shear rate D_{crit} values) is a function of polymer molecular weight, concentration and temperature [142]. The longer the macromolecular chains, the higher the viscosities and the lower the D_{crit} values at which the solutions become non-Newtonian. Similarly, the concentrations at which such polymer solutions become non-Newtonian are very low. This may explain the different values of critical shear rates observed between the 20% acrylic dope or the 4% treated samples and the 1% or 2% untreated samples.

Under given conditions, the suitability of a particular polymer solution as a spinning solution can be estimated based on its rheological behaviour. Spinnability of a polymer solution is related to its flow behaviour and spinnable solutions are recognised as possessing qualities such as the ability to form elongated and continuous fluid threadlines when e.g. drawn by hand from the solutions, as well as uniformity and ease of filtration. Now, concentrated untreated chitin solutions up to 3.5% (w/w) in DMA-8% LiCl, were heterogeneous, containing both swollen lumps and more particulate scale-like material. Liquid threads pulled out from these solutions on the end of a glass rod broke up into droplets, the remaining liquid contracting upwards away from the falling drops. As earlier indicated, it was extremely difficult to filter such solutions especially at high concentrations above 2%. Therefore, it appeared from the onset of this work that very little prospect existed in forming a continuous filament from untreated chitin solutions. Furthermore, if

one assumes a laminar flow, the apparent shear rate (D_{app}) at the spinneret hole walls encountered during spinning operations using spinneret diameters say, between 150 μm and 400 μm run into thousands (between 6×10^4 and $9 \times 10^5 \text{ sec}^{-1}$ at a flow rate, Q , of $3 \text{ cm}^3/\text{min}$, estimated from the relationship: $D_{app} = 4Q/nR^3$ where n = number of holes in the spinneret and R = radius of the spinneret hole in cm). This is a far higher shear rate than the highest value used on the viscometer (456 sec^{-1}) and even at this latter shear rate, the viscosity of a 2% untreated chitin solution is below 1 Pas. This indicates that attempts to spin such solutions will likely be unsuccessful as the viscosity at the spinneret hole wall will be even lower than 1 Pas. The material factor responsible for the break-up of a fluid jet is the ratio of surface tension to viscosity [143]. The higher the ratio, the more probable is the break-up into drops. The decrease in viscosity will therefore result in a more important contribution from surface tension forces, leading to formation of droplets as the solution emerges from the hole. This is, however, an oversimplification as spinning success or lack of it will be dependent not only on the events inside the spinneret but also those outside, such as the environment to which the polymer solution is subjected when emerging from the spinneret hole. The viscosity will tend to recover as a result of relaxation when the solution emerges from the spinneret, accompanied by an even higher increase as a result of coagulation. Thus, a 2% solution of chitin sheared at 456 sec^{-1} for 1 min to a viscosity of 0.90 Pas and sheared further at the same shear rate for 4 min (0.4 Pas) when left to relax for 10 min recovered to 0.45 Pas and to 0.60 Pas after 1 hour. The recovery of the solution from deformation was time-dependent, and

relatively slow. Furthermore, the rate of change in viscosity during coagulation may be expected to vary with the ease of coagulation, and chitin is a very slow coagulating polymer (chapter 6).

In a further attempt to investigate the effect of treating chitin in TSA/IP, the viscosity of various samples of C2 treated at different times was obtained, the results of which are shown in Table 4.9 and Fig. 4.9 for a 7% solution in DMA-8% LiCl. The results show that most of the effect of the acid took place within the first two hours of treatment. After this period not much change occurred, although a very small decrease in viscosity with time of treatment can be observed. These results are similar to those previously obtained for acetyl content and limiting viscosity number $[\eta]$. The mechanism involved in this reaction is not known, but it may be that the capacity of TSA/IP to cause chitin chain scission is limited to a specific chain size, after which the acid has no more effect on the polymer. This view appears appropriate because of the results of the following experiment. A sample (50 g, C3) was first treated in TSA/IP for 2 hours as described in section 2.2.10, at the end of which it was divided into two equal parts. The first part was washed and recovered as usual, while the second was re-treated in fresh TSA/IP for a further 2 hours after thorough washing in iso-propanol. Following the second treatment in TSA/IP, the chitin was recovered using the standard washing procedure. The effect of the double treatment in TSA/IP on viscosity as compared with the single treatment is given in Table 4.10. As can be seen, not much difference was observed in the results.

Another explanation is that the untreated chitin samples perhaps contained hydrolysable materials which could be almost completely

TABLE 4.9: Effect of treatment time in TSA/IP
on viscosity at 3.6 s^{-1} , 25°C

(Original chitin C2)

Dope concentration: 7% (w/w) chitin,
8% (w/w) LiCl

Time of treatment (h)	Viscosity ^a (Pa s)
0.5	80.2
0.5 ^b	18.6
2.0	62.0
4.0	58.9
6.0	56.7
6.0 ^c	60.4

(a) 7 days after dissolution

(b) 5% chitin

(c) Solution was sealed up in a spinning
reservoir for two months

FIG. 4.9: Effect of treatment time in TSA/IP on dope viscosity at 3.6 s^{-1} , 25°C

Dope: 7% (w/w) chitin, 8% (w/w) LiCl

Original chitin sample C2

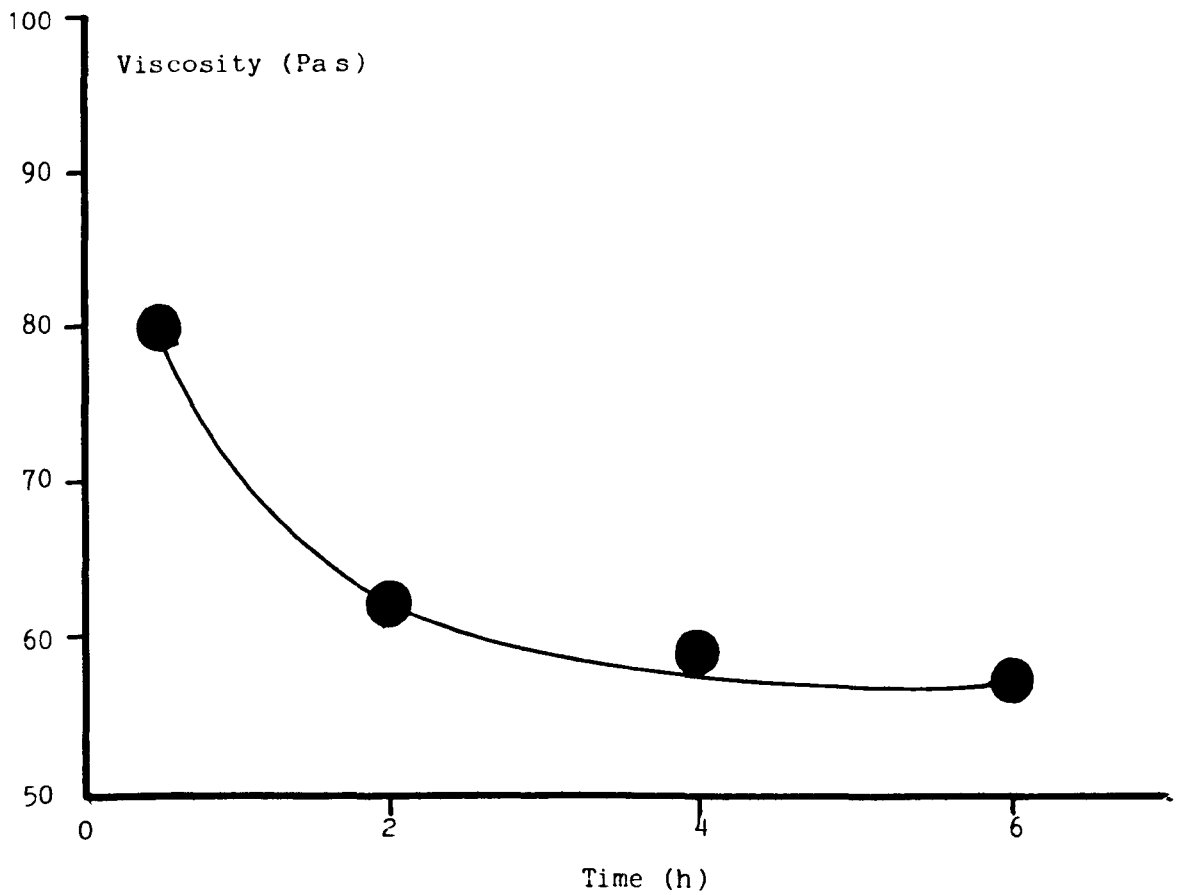

TABLE 4.10: Effect of treating chitin (C3) twice in fresh TSA/IP on viscosity at different shear rates

Temperature: 25°C

Solution: 2% chitin in DMA-8% LiCl

n	1	2	4	8	16	32	64	128	256	512
D	0.9	1.8	3.6	7.1	14.2	28.5	57.0	113.9	227.8	455.7
<u>First treatment (2 h) (A)</u>										
S	(0)	(0)	(0)	(0)	(0)	(1)	(2)	(4.5)	9	17
τ						11.20	22.30	50.20	100.40	189.70
η						0.39	0.39	0.44	0.44	0.42
<u>Part of (A) treated in fresh TSA/IP for a further 2 h</u>										
S	(0)	(0)	(0)	(0)	(0)	(1)	(2)	(4)	8	15.5
τ						11.20	22.30	44.63	89.30	172.93
η						0.39	0.39	0.39	0.39	0.38

hydrolysed within the first two hours of reaction. When once these materials are removed, the TSA/IP has no more effect on the polymer. In section 1.5, it was pointed out that chitin in nature is covalently bound to protein in what has been described as a chitin-protein complex. It has been suggested that even after drastic alkali treatment, protein residues up to 0.5% were usually left behind in chitin from many crustacean species [54]. It may just be that TSA/IP has the capacity to extract these protein residues, which were not removed during purifications in alkali nor in a further alkaline treatment with 4% NaOH at room temperature for 24 hours. This, too, seems a reasonable suggestion considering that about a 10% weight loss in the chitin samples was observed after every TSA/IP treatment.

Several methods, mostly based on acid treatments, have been suggested for reducing the molecular weight of chitin. Most of these methods were reviewed in section 1.7 and some were also tried (section 4.1.5, samples B, C and D). Those based on mineral acids seem to have both degrading and deacetylating effects on chitin as was observed for sample B which was treated in 12 N HCl for only 30 min. For TSA/IP it has been seen that the treatment has little or no effect on the composition of the chitin, although some of the analytical results indicated a less than pure material; but then the existence of pure chitin is quite rare and only reported in certain diatoms [18]. The main advantage of the TSA/IP process was the improved solubility of chitin, attributed to mainly a reduction in molecular weight by hydrolytic cleavage of the main chain. Although the increased water content observed could be ascribed to partial deacetylation, the infrared spectrum and the solubility properties of the samples showed clearly

that the increased water content must be due to other reasons eg. destruction of crystalline regions in the original chitin samples.

As a result of these experiments, the following conclusions were drawn:

- (i) The DMA-LiCl system was found to be the most appropriate solvent for chitin. Other alternative solvents examined dissolved chitin with degradation. However, unlike the DMA-LiCl system, they dissolved chitin rapidly and completely (except 12 N HCl).
- (ii) Below a molar ratio of 2.4:1 (LiCl:NAG), no dissolution of chitin occurred in the DMA-LiCl system. However, the solubility increased as the LiCl concentration was increased up to about 10% (saturation point).
- (iii) Attempts to form solutions of the original chitin in DMA-LiCl always gave evidence for incomplete dissolution at all concentrations of chitin examined. Indeed, only about 60-65% of chitin was found to be soluble even after heating at 60-80°C for over 3 hours. The insoluble materials existed either in small swollen lumps or in what appeared like scales throughout the solutions. Treatment of chitin in 4% NaOH overnight did not result in any noticeable improvement except that the chitin flakes produced became whiter.
- (iv) After treating the original chitin in TSA/IP, it became completely soluble (up to 10% by weight) in DMA-LiCl. With the original chitin, only about 3.5% chitin could be dissolved.
- (v) Chitin is generally a high molecular weight polymer. From dilute solution viscosity measurements, the $[\eta]$ value for the original chitin was found to be 27 dl g^{-1} , and $4.1-4.8 \text{ dl g}^{-1}$ for the treated samples. The molecular weights were estimated to be about 2.04×10^6 and 1.53×10^5 respectively. The molecular weights of the treated samples were

therefore lower than the original chitin by factors between about 11 and 14.

(vi) Some rheological differences existed between the solutions of the original and treated chitin samples. While the solutions of the original chitin samples were extremely dependent on shear rate, even at low shear rates, those obtained from the treated samples showed slight non-Newtonian behaviour only at above 28.5 sec^{-1} shear rate. Liquid threads pulled out from solutions of untreated chitin broke up immediately into droplets, indicating that attempts to spin such solutions would likely be unsuccessful. (Earlier, in chapter 3, it was indicated that it was not possible to produce fibres from such solutions.)

(vii) In spite of these differences between the original and treated chitin samples, their constitution was similar. This was shown through infrared spectroscopy, elemental analysis, acetyl content values, thermal stability, and optical activity.

(viii) It appeared that most of the effect of the TSA/IP treatment took place within the first 2 hours of treatment. Not much change was observed after this period, even when the treatment was repeated in fresh TSA/IP. Although the mechanism involved in the reaction is not known, some reasons were suggested to account for this behaviour.

At this stage in the work, since homogeneous chitin solutions capable of being spun could be prepared, the next effort was devoted to investigating the effects of LiCl concentration, solids content and temperature on the dope viscosity. The results are described in the next chapter.

CHAPTER 5

CHARACTERISATION OF SPINNING

DOPES BY VISCOSITY MEASUREMENT

5.1 Introduction

The ability of a polymer solution or melt to form a stable spinnable liquid filament is governed, amongst other variables associated with the extrusion process, by the viscosity of the melt or solution. Below a certain viscosity, continuous spinning is not possible because of frequent breakage in the fluid threadline, and above a certain limit it is also not possible to spin because of flow problems and possible gelation. Most of all, the magnitude of the viscosity of a dope or melt controls filtration and deaeration behaviours and affects also the homogeneity of the dope. This means that there are limits of the viscosities which can be used for fibre spinning. Therefore, it is important to know exactly those factors which govern the dope or melt viscosity.

The major factors which determine dope viscosity are shear history, molecular weight of the polymer, temperature, and concentration. The individual effects of these factors have been extensively studied for various polymer-solvent systems at high concentrations. It has been shown by several authors [137, 144-148] that the zero-shear viscosity (η_0) of polymer solutions at a fixed concentration is related to the molecular weight by an empirical equation, viz.

$$\eta_0 = KM^a \quad (5.1)$$

where 'K' and 'a' are constants. When the molecular weight is below a critical value (M_c), plots of $\log \eta_0$ versus $\log M$ give values of 'a' which vary between 1 and 2, i.e.

$$\eta_0 = KM^{1-2} \quad (\text{when } M < M_c) \quad (5.2)$$

On the other hand, when the molecular weight is above M_c and the polymer concentration high enough, the dependence of η_0 on M is much greater and the value of 'a' is found to be in the range, 3.4-3.5, viz.

$$\eta_0 = KM^{3.4-3.5} \quad (\text{when } M > M_c) \quad (5.3)$$

Figure 5.1 shows graphically the relationship between $\log \eta_0$ and $\log M$. The graph consists of two intersecting straight lines with two different slopes separated by the value of $\log M_c$. The values of M_c determined for some polymers are: polyethylene 4,000; polymethyl siloxane 29,000; polyisobutene 17,000; polystyrene 35,000 [149] and polymethyl methacrylates 42,000 [150]. It is obvious that the value of M_c varies from one polymer to another but is on average, of the order of 15,000. The value depends also on polymer concentration and is found higher for the nonpolar polymers than the polar ones, because according to Fox and Loshaek [145], polar polymers have higher inter-chain forces. Thus, chain entanglements occur at lower molecular weight in polar polymers than in nonpolar ones. Although it has been suggested that equation 5.1 can be used as an alternative method for determining polymer molecular weight, the results obtained can only be estimates as it has been found that the value of the exponent is affected by shear rate (decreasing with increase in shear rate [140, 146, 151] molecular weight distribution [141, 152] and long chain branching [141, 153]). Shearing reduces molecular entanglement and makes viscosity less dependent on molecular weight [145].

The flow of polymer solutions involves the shift of polymer molecules from one equilibrium position to another. This requires a

FIG. 5.1: Relationship between zero-shear viscosity (η_0) and molecular weight (M) of concentrated solutions of linear polymers

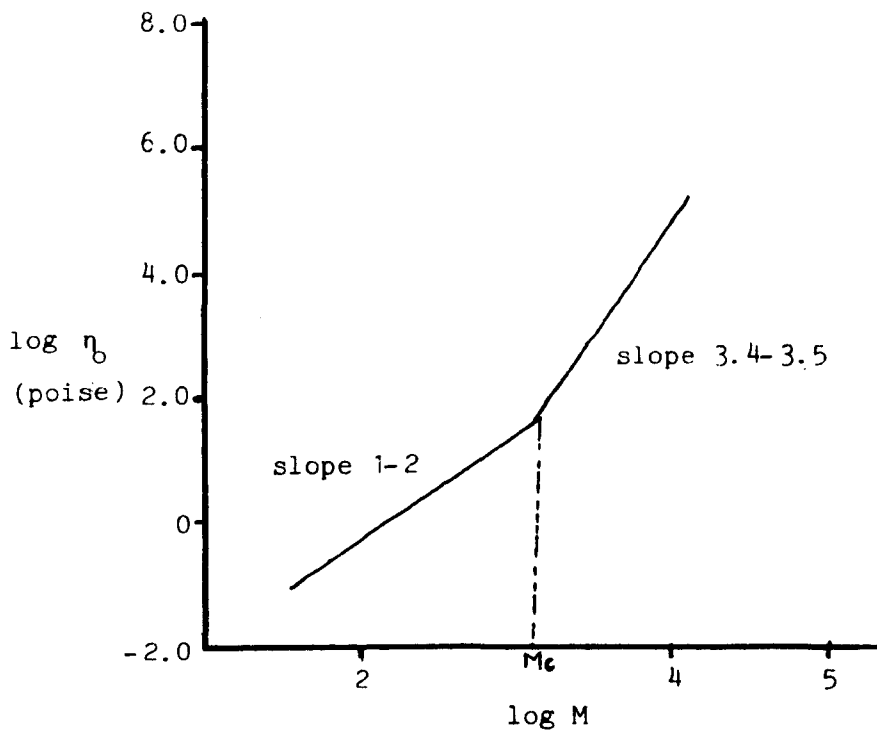

certain amount of energy called the 'activation energy' and because this energy becomes more available with increasing temperature, the ease with which polymer solutions flow increases due to the increased mobility of the polymer molecular chains. Therefore, an increase in temperature rapidly decreases the resistance to flow of polymer solutions. For many polymer solutions, the dependence of viscosity on temperature can be well represented by an Arrhenius type equation viz.

$$\eta = A \exp (E/RT) \quad (5.4)$$

where

η = viscosity of the polymer solution (poise or Pa s)

A = constant (a frequency term)

E = apparent activation energy for viscous flow (Kcal mol⁻¹ or KJ mol⁻¹)

R = the gas constant

T = absolute temperature

E can be obtained from the slope of log η versus 1/T curves. At low shear rates where polymer solutions tend to be more Newtonian, E has been observed to increase gradually with molecular weight, becoming constant in the critical molecular weight region [154].

Under practical spinning conditions the flow properties necessary for fibre formation are obtained only within a certain range of solid content, which varies from polymer to polymer and is influenced by solvent type and solution temperature. Generally, the viscosity increases as the polymer concentration increases. This relation has been shown by Johnson et al [155] to be a fifth power dependence on concentration for polyisobutylene dissolved in such solvent as xylene or

decahydronaphthalene. The relationship has been confirmed also for different polymer-solvent systems by several workers [156-158].

It was shown that at high molecular weights ($M > M_c$) and concentration (C) greater than a certain critical value (C_0), a plot of $\log \eta_0$ against $\log C$ showed that viscosity is related to the fifth or sixth power of concentration,

$$\text{ie } \eta_0 = KC^{5-6} \quad (\text{when } C > C_0) \quad (5.5)$$

However, according to Onogi et al [158] when $C < C_0$, the viscosity is related to concentration by lower powers, i.e.

$$\eta_0 = KC^{2.3-4.4} \quad (5.6)$$

Figure 5.2 shows log-log plot of η_0 versus C for polyvinyl alcohol and polystyrene due to Onogi et al [158]. The curves are similar to plots of $\log \eta_0$ versus ^{log} M earlier shown in Fig. 5.1; however, the two straight lines intersect at the critical concentrations (C_0). Above C_0 , the slopes were 6 for PVA and 5 for polystyrene and below C_0 , 4.4 for PVA and 2.3 for polystyrene. Accordingly, the dependence of η_0 on concentration (when $C > C_0$) and molecular weight (when $M > M_c$) can be expressed in a single equation, viz.

$$\eta_0 \propto C^5 M^{3.4} \quad (5.7)$$

It is not known how chitin solutions respond to the variation in parameters discussed above. The main aim of the section was to measure the solution viscosities of treated chitin (C3-6) at different concentrations suitable for fibre production. The effect of temperature on viscosity was also determined in order to assess the sensitivity of

FIG. 5.2: Log-log plot of zero-shear viscosity (η_0) versus concentration for polyvinyl alcohol (PVA) and polystyrene (PS) at 40°C
 [M = \bullet 1.23×10^6 ; \circ 5.87×10^5 ;
 \bullet 2.82×10^5 ; \circ 1.57×10^5
 for PS only][158]

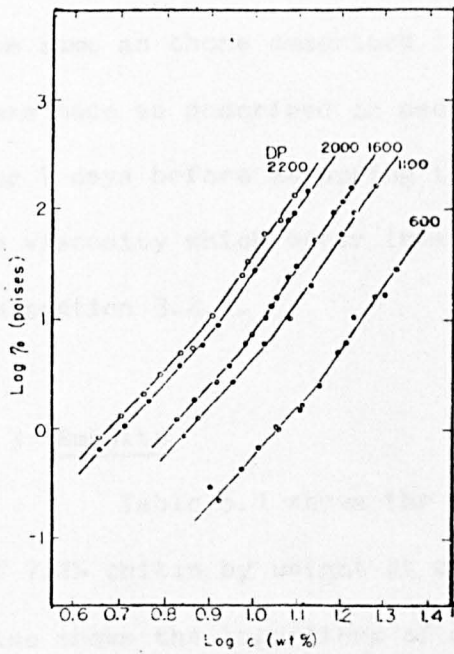

PVA

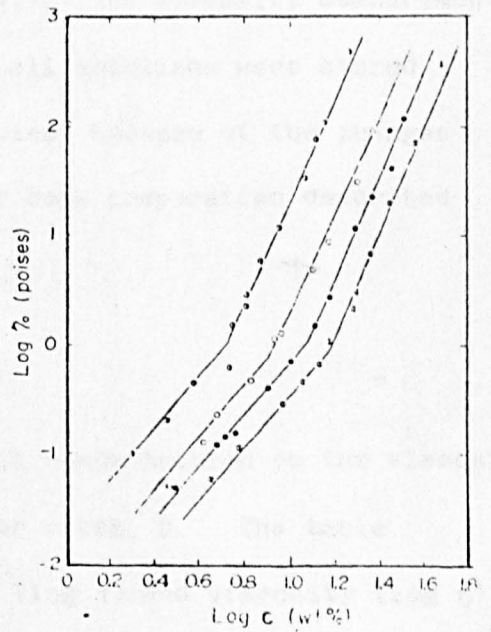

PS

the solutions to changes in temperature.

5.2 Experimental

The chitin (C3) used was treated in p-toluene sulphonic acid/isopropanol for six hours, using the procedure described in section 2.2.10. The treated chitin (C3-6) was generally dissolved in DMA-8.2% LiCl to give solutions containing 5.2 to 9.8% chitin by weight, except where the effect of LiCl concentration on dope viscosity was to be studied. In this case, the concentration of LiCl was varied between 3.5 and 10% by weight, and the solutions contained, in each case, 7.1% chitin by weight. The methods of dope preparation were the same as those described in section 2.4.1. The viscosity measurements were made as described in section 2.2.9; all solutions were stored for 7 days before measuring their viscosities, because of the changes in viscosity which occur immediately after dope preparation described in section 3.2.1.

5.3 Results

Table 5.1 shows the effect of LiCl concentration on the viscosity of 7.1% chitin by weight at different shear rates, D . The table also shows the logarithms of shear stress ($\log \tau$) and viscosity ($\log \eta$). Tables 5.2-5.5 show the details of the effect of temperature, shear rate and polymer concentration on dope viscosities. However, the effects of these variables on viscosity are not immediately clear. Therefore, Table 5.6 shows separately an extract (from Tables 5.2-5.5) of the effect of dope concentration on dope viscosity at different temperatures (25°C to 80°C) and four selected shear rates (3.6 sec^{-1} , 7.1 sec^{-1} ,

TABLE 5.1: Effect of LiCl concentration on dope viscosity
 Chitin (C3-6) 7.1% (w/w)
 Temperature 25°C

LiCl (%,w/w)	S	D (sec ⁻¹)	τ (pa)	log τ	η (Pa s)	log η
3.5	(1)	0.9	11.16	1.048	12.4	11.094
	(2)	1.8	22.31	1.349	12.4	1.094
	(3)	3.6	33.47	1.525	9.3	0.968
	(4)	7.1	44.63	1.650	6.3	0.798
	6.5	28.5	72.52	1.860	2.5	0.406
	25	455.7	278.93	2.445	0.6	-0.213
6.9	(1.5)	0.9	16.74	1.224	18.6	1.269
	(3)	1.8	33.47	1.525	18.6	1.269
	6	3.6	66.94	1.826	18.6	1.269
	12	7.1	133.88	2.127	18.6	1.269
	45	28.5	502.08	2.701	17.6	1.246
	480	455.7	5355.50	3.729	11.8	1.070
10.0	(3)	0.9	33.47	1.525	37.2	1.570
	65	1.8	72.52	1.860	40.3	1.605
	13	3.6	145.04	2.161	40.3	1.605
	26	7.1	290.08	2.463	40.3	1.605
	83	28.5	926.06	2.967	32.5	1.512
	895	455.7	9985.78	3.999	21.9	1.341

() Errors are presumed to be large

TABLE 5.2: Effect of temperature and shear rate on viscosity of
5.2% chitin in DMA-8.2% LiCl

Temp (°C)	N	1	2	4	8	16	32	64	128	256	512
25	S	0	(1.0)	(2.0)	5.0	10.0	20.0	39.0	78.0	132.0	180.0
	τ		11.16	22.31	55.79	111.57	223.15	435.15	870.27	1472.76	2008.26
	$\log \tau$		1.047	1.349	1.746	2.048	2.349	2.639	2.940	3.168	3.303
	D	0.9	1.8	3.6	7.1	14.2	28.5	57.0	113.9	227.8	455.7
	$\log D$	-0.046	0.255	0.556	0.851	1.152	1.455	1.756	2.056	2.357	2.659
	η		6.20	6.27	7.84	7.84	7.84	7.64	7.64	6.46	9.41
	$\log \eta$		0.792	0.797	0.894	0.894	0.894	0.883	0.883	0.811	0.644
30	S	0	(1.0)	(2.0)	(4.0)	8.0	16.0	30.0	55.0	98.0	123.0
	τ		11.16	22.30	44.63	89.26	176.52	334.72	613.65	1093.42	1372.35
	$\log \tau$		1.047	1.348	1.650	1.951	2.252	2.252	2.788	3.039	3.137
	η		6.20	6.27	6.27	6.27	6.27	5.88	5.39	4.80	3.01
	$\log \eta$		0.792	0.797	0.797	0.797	0.797	0.769	0.731	0.681	0.479
	40	S	0	0	(1.0)	(2.0)	5.0	9.0	18.0	32.0	60.0
τ				11.16	22.34	55.79	100.42	200.83	357.03	669.44	1004.16
$\log \tau$				1.047	1.349	1.746	2.002	2.303	2.553	2.826	3.002
η				3.10	3.13	3.92	3.53	3.53	3.13	2.94	2.20
$\log \eta$				0.792	0.496	0.593	0.547	0.547	0.496	0.468	0.343
50		S	0	0	0	(1.5)	(4.0)	7	14	25	47
	τ				16.74	44.63	78.10	156.20	278.89	524.39	736.38
	$\log \tau$				1.224	1.650	1.893	2.194	2.445	2.720	2.867
	η				2.35	3.13	2.74	2.74	2.46	2.30	1.62
	$\log \eta$				0.371	0.496	0.438	0.438	0.392	0.362	0.208
	60	S	0	0	0	(1.0)	(2.0)	(4.0)	8.0	16.0	30.0
τ					11.16	22.31	44.63	89.26	178.52	334.72	569.02
$\log \tau$					1.048	1.348	1.650	1.950	2.252	2.525	2.755
η					1.57	1.57	1.57	1.57	1.57	1.47	1.25
$\log \eta$					0.195	0.195	0.195	0.195	0.195	0.167	0.096
70		S	0	0	0	0	(1.0)	(3.0)	6.0	12.0	23.0
	τ					11.16	33.47	66.94	133.88	256.61	479.75
	$\log \tau$					1.047	1.525	1.826	2.127	2.409	2.681
	η					0.79	1.18	1.18	1.18	1.13	1.06
	$\log \eta$					-0.102	0.070	0.070	0.070	0.054	0.025
	80	S	0	0	0	0	(1.0)	(2.0)	(4.0)	8.0	16.0
τ						11.16	22.45	44.90	89.80	179.60	359.20
$\log \tau$						1.047	1.351	1.652	1.953	2.254	2.555
η						0.79	0.79	(0.79)	0.79	0.79	0.79
$\log \eta$						-0.102	-0.103	-0.103	-0.103	-0.103	-0.103

() errors are presumed to be large

TABLE 5.3: Effect of temperature and shear rate on viscosity of
6.8% chitin in DMA-8.2% LiCl

Temp. (°C)	N	1	2	4	8	16	32	64	128	256	512
25	S	(3.0)	5.0	9.0	17.5	33.5	61.5	110.0	200.0	352.0	640.0
	τ	33.47	55.79	100.41	195.25	373.76	686.16	1227.27	2231.40	3927.26	7140.48
	$\log \tau$	1.525	1.747	2.00	2.291	2.573	2.836	3.089	3.349	3.594	3.854
	η	37.61	31.34	28.21	27.42	26.25	24.09	21.55	19.59	17.24	15.67
	$\log \eta$	1.575	1.500	1.450	1.440	1.419	1.382	1.333	1.292	1.236	1.195
30	S	(1.0)	(3.5)	7.0	13.5	25.5	48.5	83.5	135.0	242.0	43.06
	τ	11.16	39.05	78.10	150.62	284.50	541.11	931.61	1506.20	2700.00	4804.32
	$\log \tau$	1.047	1.592	1.893	2.178	2.454	2.733	2.969	3.178	3.431	3.682
	η	12.40	21.94	21.94	21.15	19.98	19.00	16.36	13.22	11.85	10.54
	$\log \eta$	1.093	1.341	1.341	1.325	1.300	1.279	1.214	1.121	1.074	1.023
40	S	0	(1.5)	(3.5)	7.5	15.5	30.5	56.5	94.0	170.0	320.0
	τ		16.74	39.30	84.20	174.03	342.44	634.35	1755.38	1908.66	3592.78
	$\log \tau$		1.224	1.594	1.930	2.241	2.535	2.802	3.023	3.281	3.555
	η		9.40	11.04	11.83	12.22	12.02	11.14	9.26	8.38	7.88
	$\log \eta$		0.973	1.043	1.073	1.087	1.080	1.047	0.967	0.923	0.897
50	S	0	(1.0)	(2.5)	(4.5)	9.5	19.5	37.5	69.0	120.0	220.0
	τ		11.16	27.89	50.21	105.99	217.57	418.40	769.85	1338.88	2454.61
	$\log \tau$		1.047	1.445	1.701	2.025	2.338	2.620	2.886	3.127	3.390
	η		6.20	7.84	7.05	7.44	7.64	7.34	6.76	5.88	5.39
	$\log \eta$			0.890	0.848	0.870	0.880	0.866	0.830	0.769	0.731
60	S	0	0	(1.0)	(3.0)	6.0	12.0	24.0	46.5	82.0	145.0
	τ			11.16	33.47	66.94	133.89	267.78	518.81	914.90	1617.81
	$\log \tau$			1.047	1.525	1.826	2.127	2.438	2.715	2.961	3.209
	η			3.1	4.70	4.70	4.70	4.70	4.55	4.02	3.55
	$\log \eta$			0.491	0.672	0.672	0.672	0.672	0.658	0.604	0.550
70	S	0	0	(1.0)	(2.0)	(4.0)	8.0	16.0	33.0	61.0	93.0
	τ			11.16	22.31	44.63	89.26	178.52	368.19	680.68	1037.63
	$\log \tau$			1.047	1.349	1.650	1.951	2.252	2.566	2.830	3.016
	η			3.10	3.13	3.13	3.13	3.13	3.23	3.00	2.28
	$\log \eta$			0.491	0.496	0.496	0.496	0.496	0.509	0.475	0.357
80	S	0	0	0	(1.0)	(2.0)	5.0	11.0	22.0	43.0	77.0
	τ				11.16	22.31	55.79	122.73	245.46	479.76	859.11
	$\log \tau$				1.047	1.349	1.747	2.089	2.390	2.681	2.934
	η				1.57	1.57	1.96	2.16	2.15	2.11	1.89
	$\log \eta$				0.196	0.196	0.292	0.333	0.333	0.323	0.275

() errors are presumed to be large

TABLE 5.4: Effect of temperature and shear rate on viscosity of
8.3% chitin in DMA-8.2_LiCl

Temp. (°C)	N	1	2	4	8	16	32	64	128	256	512
25	S	5.0	10.0	19.0	36.5	67.0	118.0	200.0	370.0	632.0	1139.0
	τ	55.79	111.57	211.99	407.24	747.54	1316.56	2231.46	4128.20	7051.41	12708.16
	$\log \tau$	1.747	2.048	2.326	2.610	2.874	3.119	3.349	3.616	3.848	4.104
	η	62.68	62.68	59.55	57.20	52.50	46.23	39.18	36.24	30.95	27.89
	$\log \eta$	1.800	1.800	1.775	1.757	1.720	1.660	1.593	1.559	1.491	1.445
30	S	(3.5)	7.0	14.0	27.5	52.0	98.0	158.0	277.0	480.0	900.0
	τ	39.05	78.10	156.20	306.83	580.18	1093.41	1762.85	3090.57	5355.50	10041.57
	$\log \tau$	1.592	1.893	2.194	2.487	2.764	3.039	3.246	3.490	3.729	4.002
	η	(43.88)	43.88	43.88	43.09	40.74	38.39	30.95	27.13	23.51	22.04
	$\log \eta$	1.642	1.642	1.642	1.634	1.610	1.584	1.491	1.433	1.371	1.343
40	S	(2.0)	(4.0)	8.5	17.0	33.0	62.0	110.0	186.0	302.0	538.0
	τ	22.31	44.63	94.84	189.67	368.19	691.75	1227.30	2075.26	3369.50	6002.63
	$\log \tau$	1.349	1.650	1.977	2.278	2.566	2.840	3.089	3.317	3.528	3.778
	η	25.07	25.0	26.64	26.64	25.86	24.29	21.55	18.22	14.79	13.17
	$\log \eta$	1.399	1.399	1.426	1.426	1.412	1.385	1.333	1.260	1.170	1.120
50	S	(1.5)	(2.5)	5.5	10.5	20.5	41.5	75.5	138.0	246.0	442.8
	τ	16.74	27.89	61.37	117.15	228.72	463.03	842.38	1539.70	2744.70	4940.45
	$\log \tau$	1.224	1.445	1.788	2.069	2.359	2.666	2.926	3.187	3.438	3.694
	η	18.80	15.70	17.24	16.45	16.06	16.26	14.79	13.52	12.05	10.84
	$\log \eta$	1.274	1.195	1.236	1.216	1.206	1.211	1.170	1.131	1.081	1.035
60	S	(0)	(1.5)	(3.5)	6.5	13.5	27.5	53.0	94.0	167.0	284.0
	τ		16.74	39.05	72.52	150.62	306.83	591.33	1048.79	1863.27	3168.67
	$\log \tau$		1.224	1.592	1.860	2.178	2.487	2.772	3.021	3.270	3.501
	η		9.40	11.0	10.19	10.58	10.77	10.38	9.21	8.18	6.95
	$\log \eta$		0.973	1.040	1.008	1.024	1.032	1.016	0.964	0.913	0.842
70	S	0	(1.0)	(2.0)	(4.0)	9.0	18.0	36.0	68.0	112.0	190.5
	τ		11.16	22.31	44.63	100.42	200.83	401.66	758.70	1249.62	2125.47
	$\log \tau$		1.047	1.349	1.650	2.002	2.303	2.604	2.880	3.098	3.327
	η		6.27	6.27	6.27	7.05	7.05	7.05	6.66	5.49	4.66
	$\log \eta$		0.792	0.797	0.797	0.848	0.848	0.848	0.823	0.739	0.669
80	S	0	(1.0)	(3.0)	5.0	9.5	18.0	32.0	62.0	102.0	173.0
	τ		11.16	33.47	55.79	105.99	200.83	357.03	691.75	1138.04	1930.16
	$\log \tau$		1.047	1.525	1.747	2.025	2.303	2.553	2.840	3.056	3.286
	η		6.20	9.40	7.84	7.44	7.05	6.27	6.07	4.99	4.24
	$\log \eta$		0.792	0.973	0.894	0.871	0.848	0.797	0.783	0.699	0.627

() errors are presumed to be large

TABLE 5.5: Effect of temperature and shear rate on viscosity of
9.8% chitin in DMA-8.2% LiCl

Temp. (°C)	N	1	2	4	8	16	32	64	128	256	512
25	S	9.0	17.5	34.0	64.5	116.0	207.5	379.0	663.0	1193.0	2028.0
	τ	100.42	195.25	379.35	719.65	1294.25	2315.14	4228.62	7397.29	13310.66	22637.00
	log τ	2.002	2.291	2.579	2.857	3.112	3.365	3.626	3.869	4.124	4.355
	η	112.83	109.69	106.56	101.07	90.89	81.29	74.24	64.93	58.42	49.65
	log η	2.052	2.040	2.028	2.005	1.959	1.910	1.871	1.812	1.767	1.696
30	S	6.0	12.0	24.0	47.0	85.0	152.0	278.0	497.0	865.0	1500.0
	τ	66.94	133.89	267.78	524.39	948.37	1695.91	3101.73	5545.18	9651.06	16735.95
	log τ	1.826	2.127	2.428	2.720	2.977	3.229	3.492	3.744	3.985	4.224
	η	75.22	75.22	75.22	73.65	66.60	59.55	54.45	48.68	42.36	36.73
	log η	1.876	1.876	1.876	1.867	1.823	1.775	1.736	1.687	1.627	1.545
40	S	(3.0)	7.0	14.0	28.0	54.0	95.0	172.0	276.0	554.0	941.0
	τ	33.47	78.10	156.20	312.40	602.49	1059.94	1919.05	3079.41	6181.40	10499.02
	log τ	1.525	1.893	2.194	2.495	2.780	3.025	3.283	3.488	3.791	4.021
	η	37.60	43.88	43.88	43.88	42.31	37.22	33.69	27.03	27.13	23.04
	log η	1.575	1.642	1.642	1.642	1.626	1.571	1.528	1.432	1.433	1.362
50	S	(2.0)	(4.0)	9.0	18.0	35.5	67.5	120.0	210.0	378.0	658.0
	τ	22.31	44.63	100.42	200.83	396.08	753.12	1338.88	2343.03	4217.46	7341.50
	log τ	1.349	1.650	2.002	2.303	2.598	2.877	3.127	3.370	3.625	3.866
	η	25.07	25.07	28.21	28.21	27.81	26.44	23.50	20.57	18.51	16.11
	log η	1.399	1.399	1.450	1.450	1.444	1.422	1.371	1.313	1.267	1.200
60	S	(1.0)	(3.0)	6.0	12.5	24.5	46.5	83.0	149.0	262.0	456.0
	τ	11.16	33.47	66.94	139.47	273.35	518.81	926.06	1662.44	2923.21	5087.73
	log τ	1.047	1.525	1.826	2.144	2.437	2.715	2.967	3.221	3.466	3.707
	η	12.54	18.80	18.80	19.59	19.20	18.22	16.26	14.59	12.83	11.17
	log η	1.098	1.274	1.274	1.292	1.283	1.260	1.211	1.164	1.108	1.048
70	S	(2.0)	(3.5)	6.5	12.0	21.0	36.0	64.0	114.0	202.0	352.0
	τ	22.31	39.05	72.52	133.89	234.30	401.66	714.07	1271.93	2253.77	3927.37
	log τ	1.348	1.592	1.860	2.127	2.370	2.604	2.854	3.104	3.353	3.594
	η	25.07	21.94	20.37	18.80	16.45	14.10	12.54	11.165	9.89	8.62
	log η	1.399	1.341	1.309	1.274	1.216	1.149	1.098	1.048	0.955	0.935
80	S	(2.5)	5	7.5	11.5	18.5	31.0	51.20	84.0	100.0	120.0
	τ	27.89	55.79	83.68	128.31	206.41	345.88	571.25	937.21	1115.73	1338.88
	log τ	1.445	1.746	1.923	2.108	2.315	2.539	2.757	2.972	3.050	3.127
	η	31.34	31.34	23.51	18.02	14.49	12.14	10.03	8.23	4.90	2.94
	log η	1.496	1.496	1.371	1.256	1.161	1.084	1.001	0.915	0.690	0.468

() errors are presumed to be large

TABLE 5.6: Effect of dope concentration (in DMA-8.2% LiCl) on dope viscosity at different temperatures and shear rates (extract from Tables 5.2-5.5)

Dope conc. (% w/w)	Viscosity (η) in Pa s at						
	25°C	30°C	40°C	50°C	60°C	70°C	80°C
	<u>3.6 sec⁻¹</u>						
5.2	(6.30)						
6.8	28.20	21.90	(11.00)	(7.80)			
8.3	59.60	43.90	26.00	17.20	(11.00)	(6.30)	(9.40)
9.8	106.56	75.20	43.88	28.20	18.80	20.40	23.50
	<u>7.1 sec⁻¹</u>						
5.2	7.80	(6.30)	(3.10)	(2.40)	(1.60)		
6.8	27.40	21.20	11.80	(7.10)	(4.70)	(3.10)	
8.3	57.20	43.10	26.60	16.50	10.20	(6.30)	7.80
9.8	101.10	73.70	43.90	28.20	19.60	18.80	18.00
	<u>57 sec⁻¹</u>						
5.2	7.60	5.90	3.50	2.70	1.60	1.20	(0.80)
6.8	21.60	16.40	11.10	7.30	4.70	3.10	2.20
8.3	39.20	31.00	21.60	14.80	10.40	7.10	6.30
9.8	74.20	54.50	33.70	23.50	16.30	12.50	10.00
	<u>455.7 sec⁻¹</u>						
5.2	4.40	3.00	2.20	1.60	1.30	1.10	0.80
6.8	15.70	10.50	7.90	5.40	3.60	2.30	1.90
8.3	27.90	22.00	13.20	10.80	7.00	4.70	4.20
9.8	49.70	36.70	23.00	16.10	11.20	8.60	2.90

() Errors are presumed to be large

TABLE 5.7: Log-log effect of dope concentration on dope viscosity at shear rate 7.1 sec^{-1}

Log of dope conc. (%,w/w)	Viscosity (η) in Pas at						
	25°C	30°C	40°C	50°C	60°C	70°C	80°C
	<u>7.1 sec^{-1}</u>						
0.716	0.892	(0.799)	(0.491)	(0.380)	(0.204)		
0.833	1.438	1.326	1.072	(0.851)	(0.672)	(0.491)	
0.919	1.757	1.634	1.425	1.217	1.009	(0.799)	0.892
0.991	2.005	1.867	1.642	1.450	1.292	1.274	1.256

()Errors are presumed to be large

FIG. 5.3: Effect of LiCl concentration on dope viscosity (at 25°C)
Chitin 7.12%, w/w

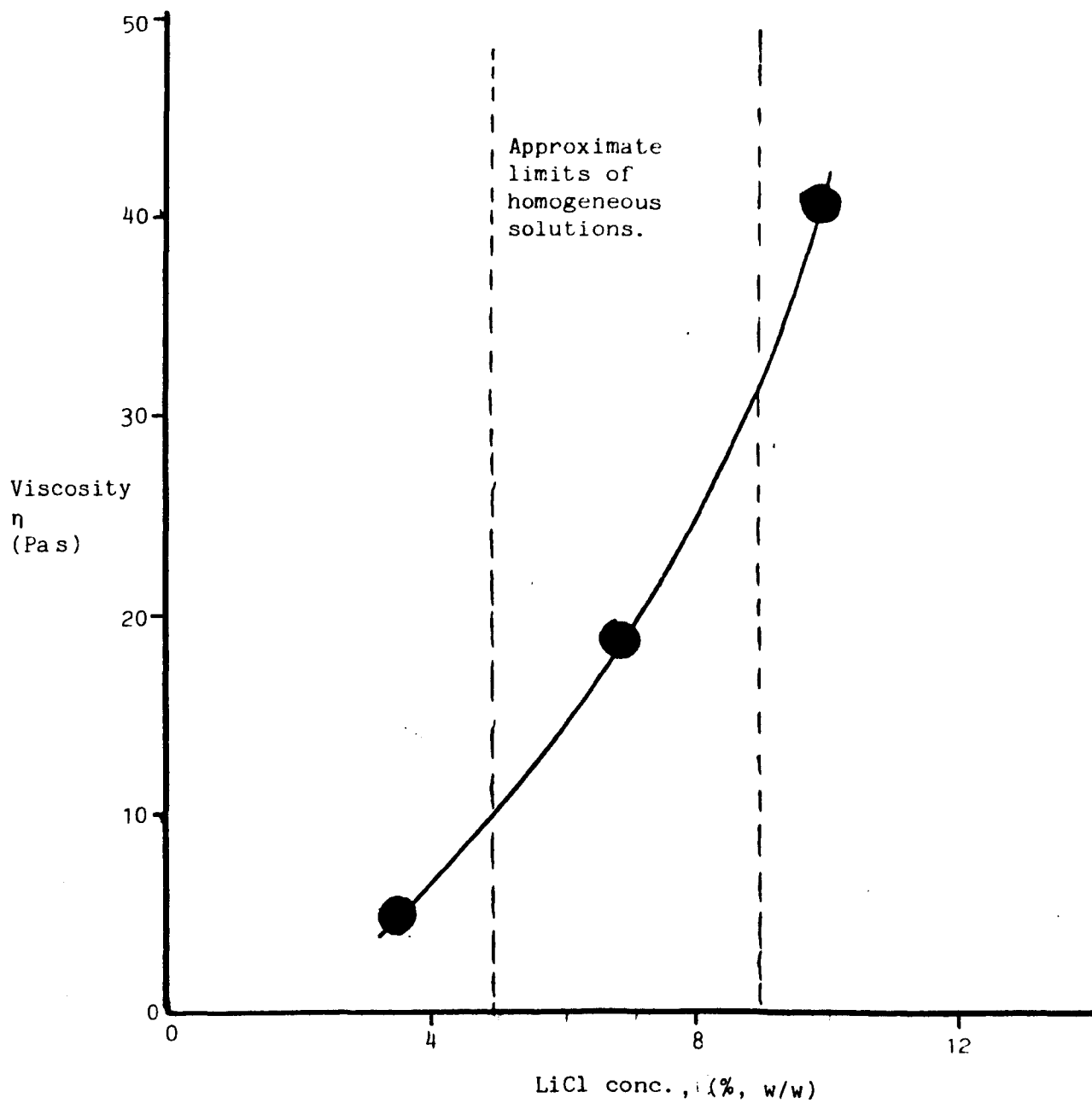

FIG. 5.4: Log viscosity versus log shear rate of 7% (w/w) chitin solutions containing different amounts of LiCl

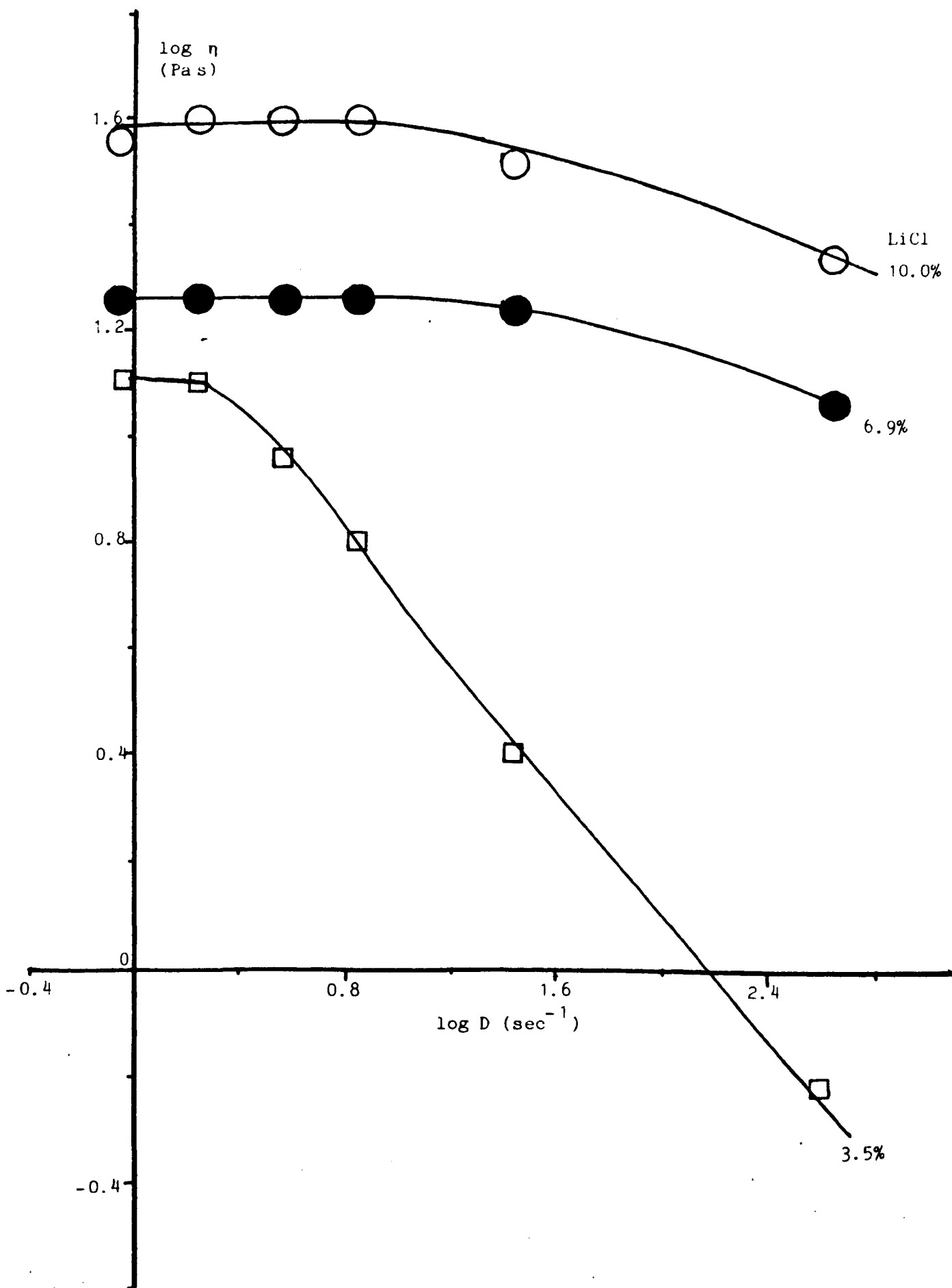

FIG. 5.5: Effect of dope concentration (in DMA-8.2% (w/w) LiCl) on dope viscosity at 25, 40 and 60°C (shear rate 7.12 sec^{-1})

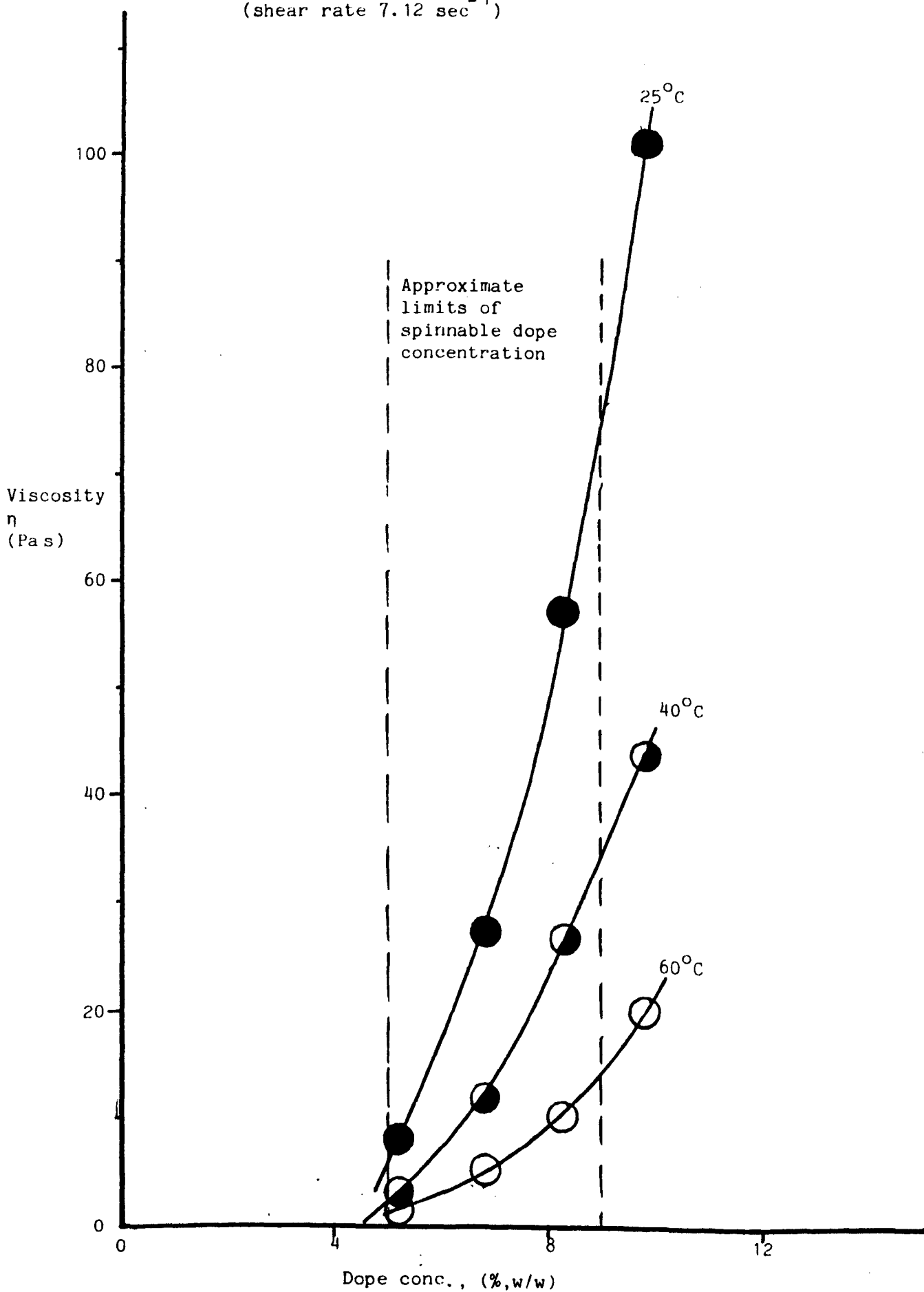

FIG. 5.6: Effect of dope concentration (in DMA-8.2% (w/w) LiCl) on dope viscosity at 25, 40 and 60°C (shear rate 7.12 sec^{-1})

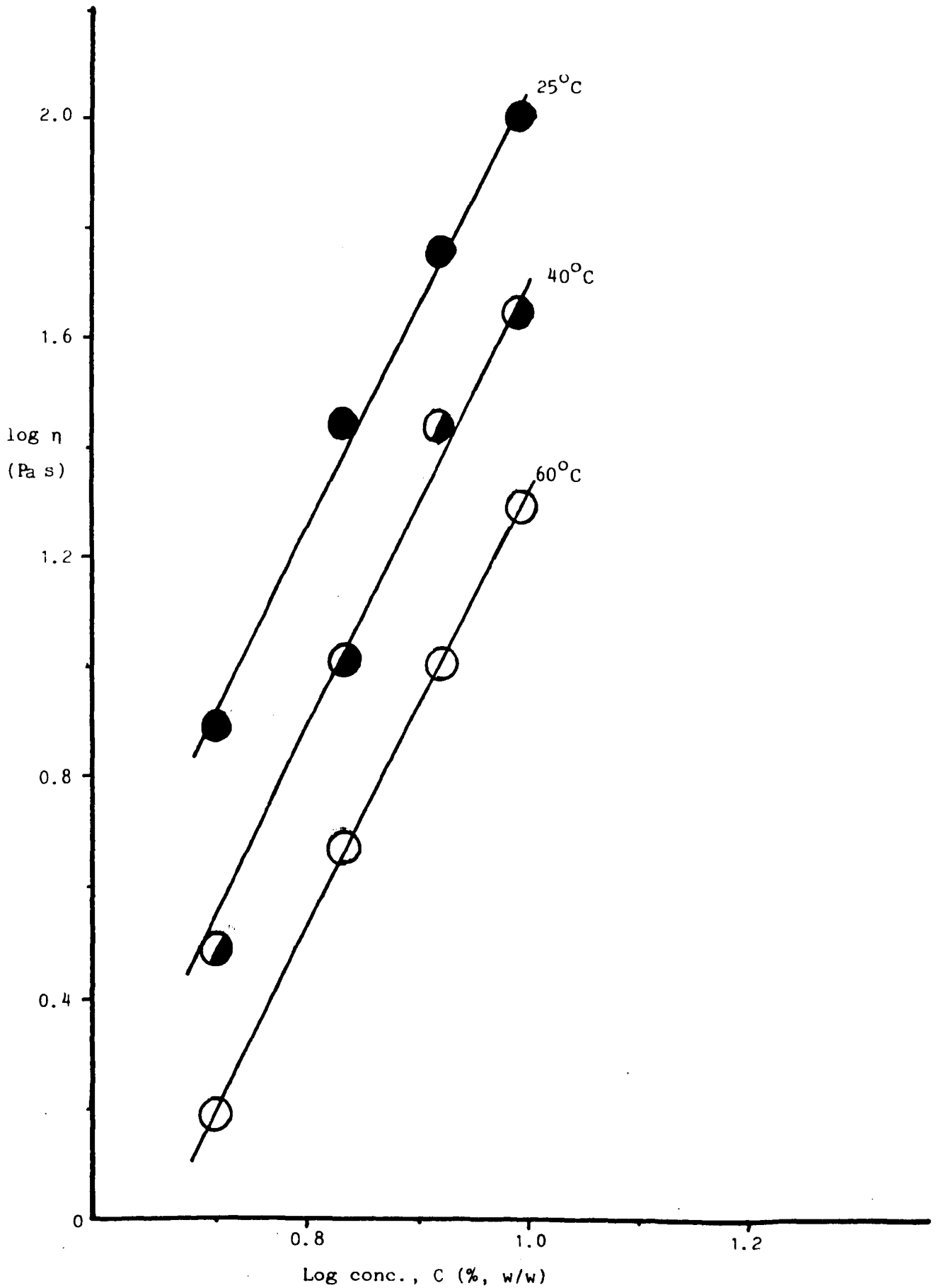

FIG. 5.7: Effect of temperature on dope viscosity
(shear rate 7.1 sec^{-1})

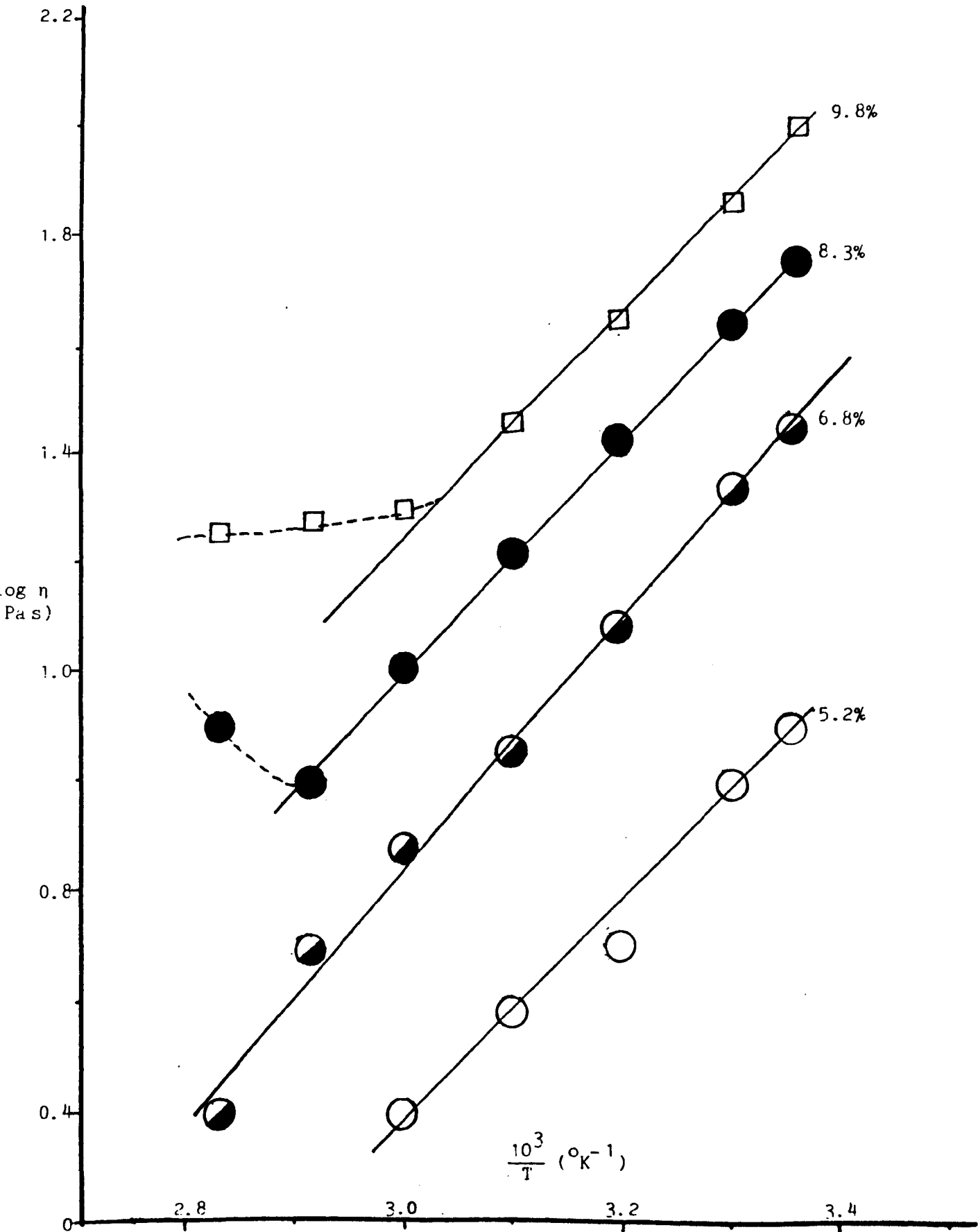

FIG. 5.8: Effect of varying shear rate on dope viscosities at different temperatures for various dope concentrations

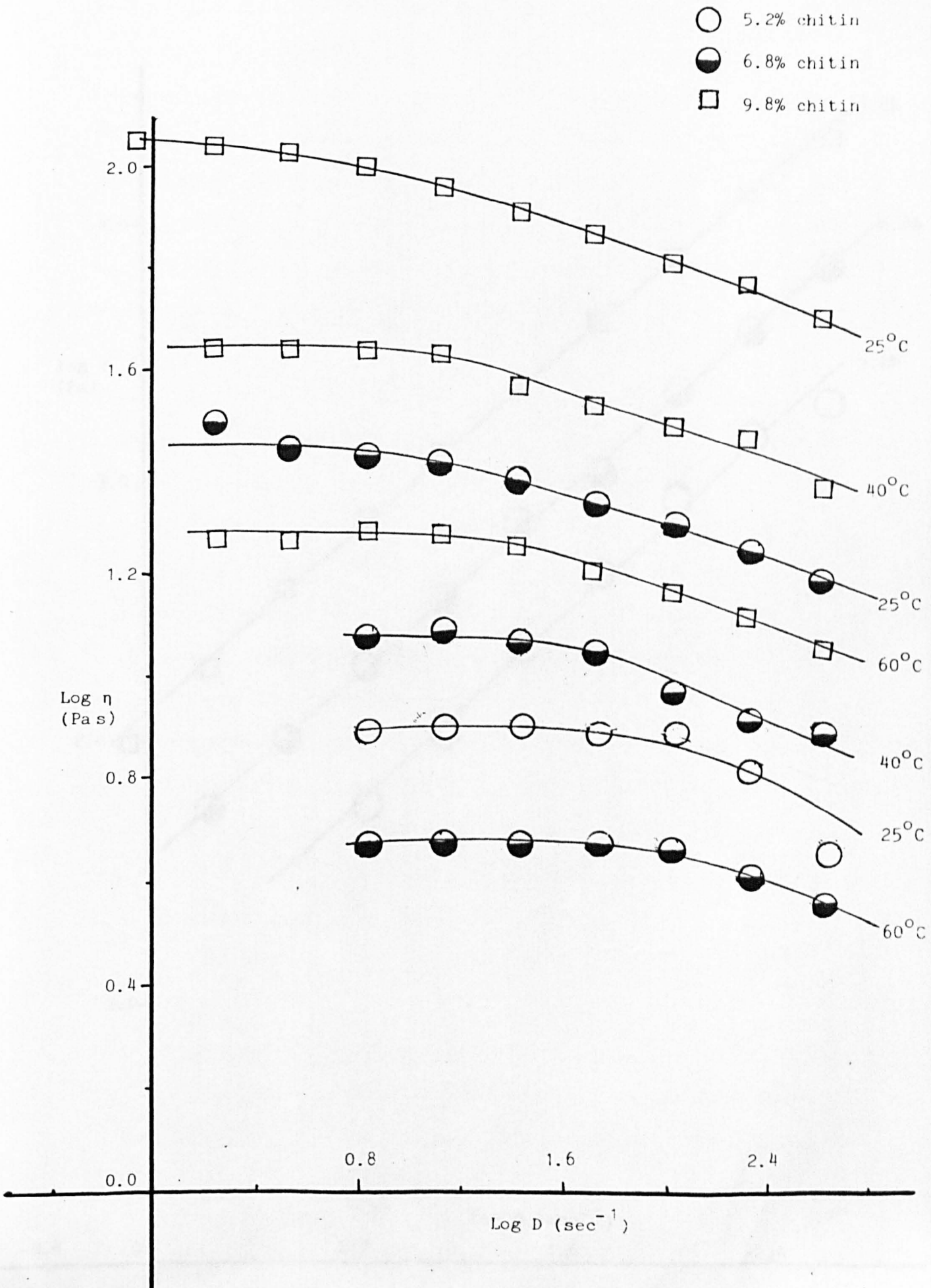
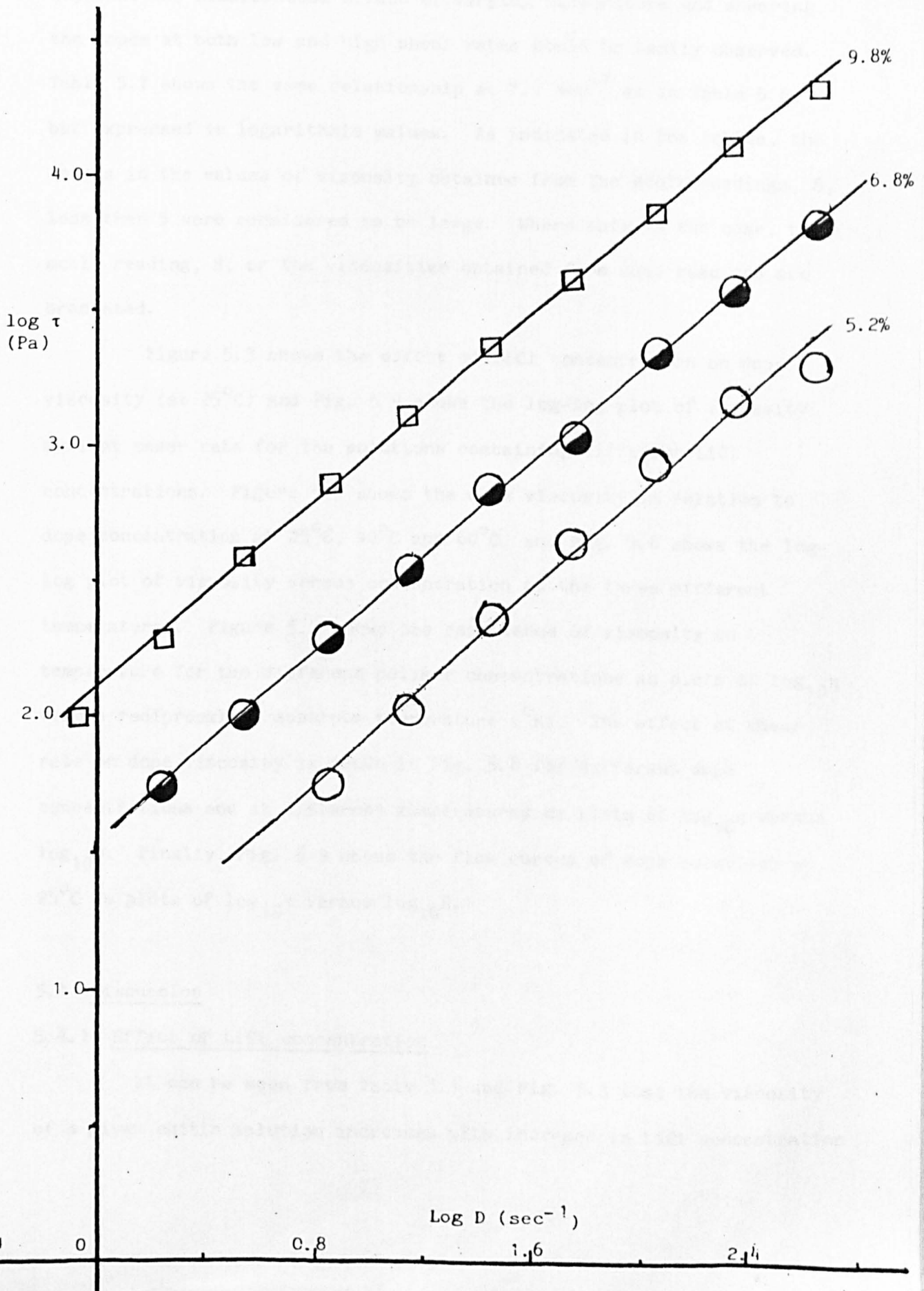

FIG. 5.9: Typical flow curves of dope solutions at 25°C



57 sec^{-1} and 455.7 sec^{-1}). The shear rates were selected in such a way that the simultaneous effect of varying temperature and shearing the dopes at both low and high shear rates could be easily observed. Table 5.7 shows the same relationship at 7.1 sec^{-1} as in Table 5.6, but expressed in logarithmic values. As indicated in the tables, the errors in the values of viscosity obtained from the scale readings, S , less than 5 were considered to be large. Where this is the case, the scale reading, S , or the viscosities obtained from such readings are bracketed.

Figure 5.3 shows the effect of LiCl concentration on dope viscosity (at 25°C) and Fig. 5.4 shows the log-log plot of viscosity against shear rate for the solutions containing different LiCl concentrations. Figure 5.5 shows the dope viscosity in relation to dope concentration at 25°C, 40°C and 60°C, and Fig. 5.6 shows the log-log plot of viscosity versus concentration at the three different temperatures. Figure 5.7 shows the dependence of viscosity on temperature for the different polymer concentrations as plots of $\log_{10}\eta$ versus reciprocal of absolute temperature ($^{\circ}\text{K}$). The effect of shear rate on dope viscosity is shown in Fig. 5.8 for different dope concentrations and at different temperatures as plots of $\log_{10}\eta$ versus $\log_{10}D$. Finally, Fig. 5.9 shows the flow curves of dope solutions at 25°C as plots of $\log_{10}\tau$ versus $\log_{10}D$.

5.4 Discussion

5.4.1 Effect of LiCl concentration

It can be seen from Table 5.1 and Fig. 5.3 that the viscosity of a given chitin solution increases with increase in LiCl concentration

in the solution. The increased viscosity was considered to be due to two main factors:

(i) Though the experimental results are not shown, it was observed that DMA/LiCl solutions alone show an increase in viscosity with increasing LiCl concentration.

(ii) It is possible that an increase in LiCl concentration promotes better chitin solubility, and hence greater chain extension in solution.

Under the conditions examined, it was not possible to dissolve completely 7.12% chitin at or below 3.5% (w/w) LiCl, even after stirring for over 12 hours, but as the salt concentration increased, the solubility of the chitin increased and it was possible to dissolve all the chitin in between 5 and 10% LiCl. However, when the salt concentration was at or above 10% (w/w), cloudy solutions were obtained. The saturation point of LiCl in DMA at room temperature was observed to be around 10%, and the cloudiness was associated with undissolved LiCl; a similar saturation level is quoted by others [116]. (For cellulose in DMA-LiCl [129], it was found that amounts of LiCl less than about 3% were insufficient to dissolve the cellulose. With amounts higher than 15%, the amide becomes supersaturated and tended to salt the dissolving cellulose out of solution. The higher LiCl saturation point noted with cellulose could be due to the fact that cellulose does not dissolve in DMA/LiCl except when heated to about 150°C. Moreover, the authors used DMA/LiCl/H₂O (>5%) as their solvent. In a system which did not involve the incorporation of water, a saturation point of 11% was claimed [115].) Heating the solutions gently between 40-80°C and stirring vigorously made the cloudiness disappear, only for it to reappear on cooling to room temperature. The broken lines in Fig. 5.3

show the limits of LiCl concentration at which clear and homogeneous solutions suitable for spinning were obtained.

Figure 5.4 shows the variation of $\log \eta$ (viscosity) with $\log D$ (shear rate). Generally, non-Newtonian behaviour was exhibited by all the solutions. However, solutions containing 6.9 and 10% LiCl showed a relatively small response to the increase in shear rate deviating from Newtonian behaviour only at high shear rates, especially for the 6.9% solution. On the other hand, the solution containing 3.5% LiCl showed a very sharp decrease in viscosity with increase in shear rate even at low shear rate. This behaviour is similar to the behaviour of the untreated chitin (C1, C2 and C3) solutions especially the 1% solution of C2 (chapter 4, Fig. 4.6). Although the reason for the extreme shear thinning behaviour is not clear, it was presumed to be due, in this case, to some weak aggregations between polymer chains due to the low LiCl content.

5.4.2 Effect of dope concentration

The influence of dope concentration on the viscosity is shown in Figs. 5.5 and 5.6 at three different temperatures (25°C , 40°C and 60°C). Generally the viscosity increased exponentially with increase in the polymer concentration. However, the viscosity did not change so much until approximately 8% by weight chitin was reached. Then increasing addition of the polymer resulted in marked increases in viscosity at 25°C . Under the conditions examined, an upper limit of 10% by weight polymer was reached. The broken lines shown in Fig. 5.5 indicate the lower and upper limits within which spinnable dopes were made. Below 5% by weight polymer, the viscosity became very low and it

was practically impossible to spin continuously as a result of frequent breakages of the filaments in the coagulating bath. Above 9% by weight polymer, the viscosity was very high and this resulted in very low flow rates, ineffective filtration and deaeration, rapid skin formation and rapid gelation on heating or standing. As will be shown later, the increase in dope viscosity with increasing chitin concentration did not result in significant changes in fibre properties. Again because of this insensitive behaviour, it was not possible to establish an optimum dope viscosity. However, the properties of fibres spun from dope solutions containing 5, 7 and 9% by weight chitin showed the 7% dope to give the best properties (chapter 6). This corresponds to a dope viscosity of about 62.0 Pas (620 poise at 25°C, shear rate 3.6 sec⁻¹) for the C2-2 chitin sample dissolved in DMA-8% LiCl. It must be noted that changes in chitin sample, treatment time, LiCl concentration and temperature will result in different viscosity values.

Earlier in the introduction (section 5.1), it was indicated that a log-log plot of viscosity against concentration can be expressed by the equation $\log_{10}\eta = n \log C + \log K$ i.e. $\eta = KC^n$ where n and K are constants and C is the % polymer concentration (w/w). Figure 5.5 indicates an exponential relationship between viscosity and concentration and when plotted on a log-log basis as shown in Fig. 5.6, a linear relationship was obtained. The data (Table 5.8) showed that at shear rate 7.1 sec⁻¹, the viscosity can be expressed by the equations:

$$\log_{10}\eta = 4.0 \log_{10}C - 1.97 \text{ (at } 25^{\circ}\text{C)}$$

$$\log_{10}\eta = 4.2 \log_{10}C - 2.47 \text{ (at } 40^{\circ}\text{C)}$$

TABLE 5.8: Constants for the expression of dope viscosity in equation $\eta = KC^n$

Dope temperature (°C)	K	n
25	-1.97	4.0
40	-2.47	4.2
60	-2.65	4.0

$$\log_{10}\eta = 4.0 \log_{10}C - 2.65 \text{ (at } 60^{\circ}\text{C)}$$

At shear rate 3.6 sec^{-1}

$$\log_{10}\eta = 4.5 \log_{10}C - 2.3 \text{ (at } 25^{\circ}\text{C)}$$

While it appeared that the value of constant n was not affected by increase in temperature, it increased slightly at a lower shear rate of 3.6 sec^{-1} (at 25°C), indicating that the relationship (as expected) is affected by shearing.

It can be seen also that viscosity is related to concentration by a power similar to that earlier mentioned for PVA at concentrations below the critical value (C_0), where chain entanglements are believed to be less effective. That is, $\eta = KC^{4.0-4.5}$. The lower power relationship obtained (usually $\eta_0 = KC^{5-6}$ when $C > C_0$) was presumed to be due to chain stiffness in chitin which had prevented effective chain entanglement. It is believed that the tendency toward entanglement decreases with the rigidity of the chain [159]. The value of 4-4.5 is slightly less than the value of 5 obtained by Landel et al [160] for cellulose tributyrate and cellulose trinitrate in various solvents. Incidentally, the exponential relationship between viscosity and concentration is also affected by the nature of solvent employed.

5.4.3 Effect of temperature

It is well established that viscosities of polymer solutions decrease with increasing temperatures and chitin solutions are no exceptions. Table 5.7 shows the $\log \eta$ values from 25°C to 80°C for the four different polymer concentrations at 7.1 sec^{-1} . The data shows a steady decrease in viscosity at each concentration with increasing temperature. However, above 70°C for both the 8.3% and 9.8% by weight

chitin dopes, an upturn in viscosity at low shear rate was observed. This is shown in Fig. 5.7, but it can be seen much better in Tables 5.4 and 5.5 at shear rates between 0.9 sec^{-1} and 3.6 sec^{-1} . The upturn was due to gelation which was observed to occur in all concentrated dopes (>8%) when they are kept at temperatures above 60°C for over 4 hours. When cooled to room temperature and allowed to relax, solutions recovered close to their original viscosities (depending on their shear history), but solutions that gelled on heating remained gelled.

Plots of $\log_{10}\eta$ against $\frac{1}{T}$ are shown in Fig. 5.7 for the different concentrations. In general plots are linear except for the higher concentrated solutions at the higher temperature where gelation occurs. For the linear regions, the change in viscosity with temperature is usually related by an equation of the form:

$$\log_{10}\eta = A + \frac{B}{T}$$

where A and B are constants and T is the temperature ($^{\circ}\text{K}$). By analogy with the Arrhenius theory of reaction velocities,

$$\log_{10}\eta = \log_{10}A + E_v/2.303 RT$$

so a plot of $\log_{10}\eta$ versus $1/T$ should be linear with a slope = $E_v/2.303 R$ and an intercept of $\log_{10}A$. E_v is the activation energy of flow (KJ.mol^{-1}). Values of A and B calculated from the data using regression analysis are shown in Table 5.9 for each dope concentration studied.

It appears that the activation energy for viscous flow is almost independent of dope concentration. Generally E_v is said to be related to the structure and composition of polymers, with low values (<29 KJ/mole) denoting high chain flexibility and weak intermolecular forces as in

TABLE 5.9: Constants in equation $\log_{10}\eta = A + \frac{B}{T}$
and the corresponding activation energy
of viscous flow, E_v

Dope concentration (%)	A	$10^{-3}B$ °K	E_v KJ.mol ⁻¹	(Kcal.mol ⁻¹)
5.2	-5.84	2.01	38.5	(9.20)
6.8	-5.83	2.16	41.4	(9.90)
8.3	-5.48	2.16	41.4	(9.90)
9.8	-4.79	2.02	38.7	(9.30)

linear polyethylenes (25-29 KJ/mole) and polydimethylsiloxanes (15 KJ/mole). Higher values are quoted for polycarbonate (85 KJ/mole) and polyvinyl chloride (145 KJ/mole) [161]. According to Landel et al [160], the apparent activation energy for viscous flow (determined for cellulose tributyrate in acetone over various polymer concentration and molecular weight ranges) is a single function of the product of concentration (C in $\text{g}\cdot\text{cm}^{-3}$) and molecular weight (M) over a certain range of CM . In this range (0-20,000) it increases by about $5 \text{ kcal}\cdot\text{mol}^{-1}$ but at higher concentration very little change occurs. At temperatures between -5 and 40°C , the values of activation energy obtained (when $\bar{M}_n = 152,000$ and $C = 0.1$ to $0.23 \text{ g}/\text{cm}^3$) were between 8.53 and 10.4 kcal (35.7 - $43.5 \text{ KJ}\cdot\text{mol}^{-1}$) indicating a close similarity with the values obtained for chitin.

5.4.4 Effect of shear rate

The viscosity of the various dopes studied was found to be shear dependent at high shear rates. This is shown in Fig. 5.8 for three different dopes at temperatures between 25°C and 60°C . As the temperature increased, all the solutions tended to exhibit more Newtonian behaviour. One way of characterising this behaviour as indicated in section 4.1.7 is to measure the so called flow index. This, when measured for the dopes at 25°C and at low shear rates ($<10 \text{ sec}^{-1}$) was about 0.97 indicating a quite Newtonian behaviour at low shear rates. This is further illustrated in Fig. 5.9 which shows the flow curves in the form of $\log \tau - \log D$ plots for the three dopes at 25°C . It is evident that the flow behaviour of the dopes at room temperature was almost Newtonian at low shear rates.

From these experiments the following conclusions were drawn:

1. The viscosity of a given chitin solution increased with increase in LiCl concentration in the solution.
2. Dopes suitable for spinning could only be obtained when 5 to 9% LiCl was added to the solutions. Below 5% LiCl, not all the chitin dissolved, and above 9% very cloudy solutions were obtained. The cloudiness was presumed to be due to undissolved LiCl.
3. The dope viscosities were observed to increase exponentially in form: $\eta = KC^{4.0-4.5}$ with increase in chitin concentration. This behaviour is observed with most polymer solutions except that in most of these cases, the values of the index are slightly higher than those obtained for chitin.
4. Approximate limits of spinnable dope concentrations were between 5 and 9% chitin. Below 5% the dope became very thin and above 9%, the viscosity became very high, resulting in increased gelation at high temperatures or when not properly sealed. Although increases in temperature resulted in rapid decreases in viscosity regardless of concentration, it was observed that dopes containing above 8% chitin appeared to gel at high temperatures (above 60°C).
5. The apparent activation energies for viscous flow calculated for the solutions examined were between 38.5 and 41.4 KJmol^{-1} . These values were similar to those of cellulose tributyrates in acetone obtained by Landel et al [160].
6. Within the conditions used in these experiments, there was no indication of the transition temperatures (when $\log \eta$ was plotted against $\frac{1}{T}$) of the nature described by Navard and Haudin [102] for

mesomorphic solutions of cellulose in N-methylmorpholine N-oxide presumably indicating that no mesomorphic phases were formed in the chitin solutions examined.

7. The viscosities of the solutions (as observed for most high concentrated polymer solutions) were shear dependent but only at high shear rates.

CHAPTER 6

ASSESSMENT OF COAGULATION

BEHAVIOUR IN THE SPINNING OF CHITIN FIBRES

6.1 Introduction

All man-made fibre production requires some sort of extrusion process in which the extruded fluid threadlines are converted into solid filaments by cooling (melt-spinning) or evaporation of solvent (dry-spinning) or extraction of the solvent with a nonsolvent (wet-spinning). In each of the spinning techniques, the solidification stage is very important because the structure and mechanical properties of the fibres so produced are greatly influenced by the type of solidification variables under consideration.

In wet spinning the solidification process (usually referred to as coagulation) is essentially a mass transfer process which involves one or both of the following:

- a) the nonsolvent (coagulant) may enter the threadline;
- b) the solvent may diffuse from the threadline.

After a sufficient length of time, no more exchange takes place, indicating probably an equilibrium state between the solvent and the nonsolvent [162, 163]. In many wet spinning systems, it is quite difficult to decide whether solvent efflux or nonsolvent influx is the dominant process, or whether the two fluxes operate at the same rate. Each of the three mechanisms yield different micro- and macro-structures [164]. Most explanations for these differences have been based on the thermodynamic and kinetic relations of phase separation processes [163-166]. A typical phase diagram of polymer-solvent-nonsolvent is shown schematically in Fig. 6.1. The explanation of the diagram given below is based on the reviews by Strathmann and Kock [163], Ziabicki [166], and the work by Strathmann et al [165]. The corners of the triangle represent the three components, ie. polymer, solvent and nonsolvent, while any point

FIG. 6.1: Phase diagram of the system of polymer-solvent-nonsolvent showing various coagulation paths

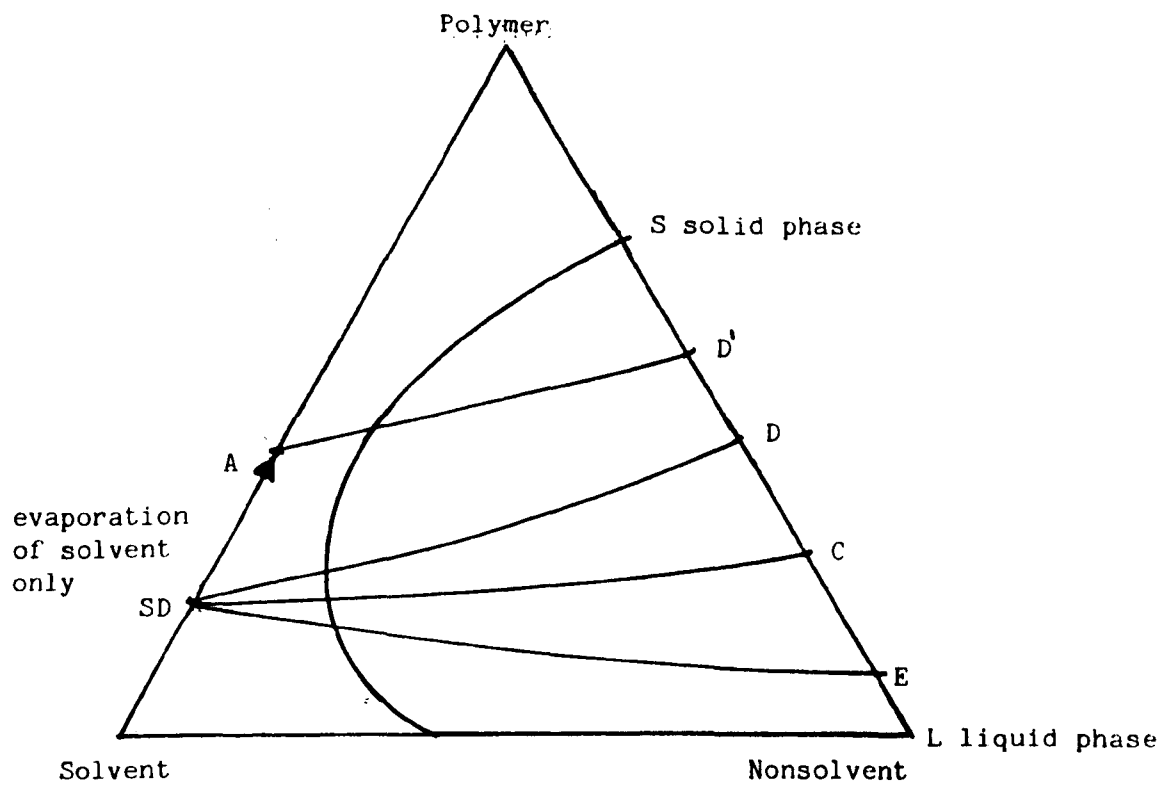

within the triangle represents a mixture of three components. The system consists of two regions: a one-phase region where all components are miscible and a two-phase region where the system separates into a polymer-rich, generally solid phase and a polymer-poor, generally liquid phase.

The original state (spinning dope, SD) undergoes a change of composition dependent on the efflux of solvent, j_s , and the influx of nonsolvent, j_n to a composition C, which represents the final material. At C, two phases are in equilibrium, a solid (polymer-rich) phase represented by point S, and a liquid (polymer-poor) phase, represented by point L. The position of C on the line S-L depends on the flux ratio (j_s/j_n) and determines the overall porosity of the material. Generally, if the coagulation is such that the nonsolvent enters the threadline faster than the solvent leaves (ie. when $j_s/j_n < 1$; path SD-E), the resultant fibre structure is highly porous. However, when the solvent leaves the threadline faster than nonsolvent enters (ie. when $j_s/j_n > 1$; path SD-D), the result is a dense and homogenous fibre structure. Path SD-C is the coagulation path when solvent leaves and nonsolvent enters at the same rate (ie. when $j_s/j_n = 1$) The route SD-A-D' corresponds to when no nonsolvent is involved, as in dry spinning ($j_n = 0$).

The ratio of fluxes j_s/j_n is controlled by such coagulation variables as coagulant composition and temperature, dope concentration and the particular polymer-solvent system. In most wet spinning systems, it is generally believed that most coagulation variables that retard the rate of coagulation often result in superior fibres which are apparently voidless. Thus, in acrylic spinning systems where the mechanisms of coagulation and void formation have been studied to a

great extent, it is believed that increasing bath temperature leads to rapid coagulation and formation of macro-voids [117,120,167]. The effect of temperature on the fluxes j_s and j_n is different for the individual components but generally the ratio j_s/j_n increases with temperature [162,168]. An increase of solvent content in the spinning bath reduces the driving force for diffusion and consequently the efflux of solvent and influx of nonsolvent. This generally gives fibres with homogeneous structures. Again, the ratio j_s/j_n has been observed to increase with solvent content in the bath [162,168]. On the other hand, the diffusion coefficients of both solvent and nonsolvent generally decrease with increasing dope concentration [168,169]. It should be noted that the effect of each coagulation variable mentioned above may vary from one polymer-solvent system to another.

During the preliminary study of the spinning process (chapter 3), it was constantly pointed out that drying the fibres after coagulation on the chrome rollers in the spinning was very difficult. The reason for this was believed to be that the fibres contained quite a large amount of solvent still trapped in them, which was forced out under heat during drying causing stickiness. Besides, the fibres spun into all the coagulants appeared to be highly swollen. In view of these problems, it was decided to carry out some measurements of the coagulation behaviour of the chitin-DMA/LiCl-nonsolvent system.

Many methods are available to measure and compare the activity of various spinning baths or spinning conditions towards spinning dopes [162,170,171]. Some of the methods include:

a) Determination of the coagulation power

This involves the determination of the so-called coagulation value which is defined as the volume of nonsolvent required for the precipitation of polymer from the unit volume of its dilute solution [172]. It is based on the fact that transition between polymer solution and coagulation usually occurs over a reasonably small range of nonsolvent concentration especially in a very dilute polymer solution. A critical coagulation concentration can therefore be determined quite sharply. However, the exact value of such an experiment for a visual assessment is subjective and therefore depends upon the criterion which is set for judging whether, or not, the solution has coagulated. This kind of judgement may not in fact remain consistent during a whole series of experiments. Nevertheless, coagulation values can be determined by turbidity measurements. One of such methods, described by Wijmans et al [170], involves placing the polymer solution in a vessel which is kept at a constant temperature (25°C normally). This is followed by slow addition of the coagulant to the solution (with stirring) until permanent turbidity is detected visually. The volume of the nonsolvent that produces the visible change is regarded as the coagulation value/volume of the polymer solution. The addition of mixtures containing a considerable fraction of solvent is favoured over the addition of pure nonsolvent since in the latter case, every drop added will cause local coagulation in the polymer solution. The disadvantage of the method in characterising phase equilibria in ternary polymer-solvent-nonsolvent systems is that most of the information obtained is limited to very low polymer concentrations (below 1%) [172].

b) Boundary movement

This method has been extensively studied by Paul [162] and Booth [171] and used for assessing coagulation power. The workers have indicated that solidification in the bath is usually accompanied by formation of a rigid layer on the surface of the solution and that the layer has a very distinct boundary which gradually moves inward with time. Such partially coagulated polymer solution is made up of two layers; one is the hard coagulated part (plus retained liquid) and the other is the soft original gel. The movement of the hard portion can be visually observed using a powerful microscope or photographed at constant intervals. Such a method involves immersing gelled rods of polymer solution in coagulated baths for various lengths of time. At such a prescribed time, the sample is removed from the bath and cross-sectioned with a razor blade. The cross-section can then be viewed and the depth of penetration measured using a microscope with a calibrated scale attached. Although the method appears simple, two main problems can be envisaged during the measurement. Firstly, the problem of cross-sectioning a partially coagulated polymer without deforming the filament and disturbing the nonsolvent and solvent flow. Secondly, it may be difficult, for fibres, to mount the section in a vertical plane using an ordinary microscope without wasting too much time. If too much time is taken to mount the filaments, full coagulation may occur before measurements can be made.

c) Other methods are based on the variation of physical characteristics of the partially coagulated filaments. Such methods as measurement of the distance from the spinneret at which the filaments become opaque and measurement of the maximum take-up velocity as a measure of

spinnability have been used. Apart from the non-opacity of the chitin filaments in the nonsolvents studied, both methods are highly affected by spinning conditions such as extrusion rates and spinneret dimensions. Therefore, other methods of measurement (based on the measurement of the solvent retained in the filament after coagulation, diameter of the extrudates and observation of the outward diffusion of the solvent from the fluid threadlines in the coagulation bath) were employed. The amount of solvent/nonsolvent left in the filament was determined through measurement of the parameter known especially in viscose spinning as gel swell factor (GSF). The measurement is based on the weight of the swollen fibre after the removal of inter-filament liquid divided by the weight of the completed dried filaments. A high ratio indicates a very swollen filament indicating poor coagulation and vice versa. The procedure used was based on the method used for estimating wool fibre damage by swelling measurements described by Brown [173].

6.2 Experimental

The spinning solutions containing 7% chitin (C3-2), hydrolysed for 2 hours as described in section 2.2.10 and 8% LiCl by weight, were prepared as described in section 2.4.1 except where otherwise indicated. The fibres were produced by wet spinning and dry-jet wet-spinning as described previously in section 2.4.4. The spinning conditions are shown in Table 6.1

6.2.1 Measurement of GSF

Before starting, the bottom of the four centrifuge tubes used were each filled with about 2-3 g of cotton-wool to heights of

TABLE 6.1: Spinning conditions

Chitin:	C3-2
Pump speed:	3 rpm
First advancing reel speed:	18 rpm (10.3 m/min)
Spinneret:	150 μ m 10 holes except where otherwise indicated
Linear rate of extrusion:	17 m/min
Jet stretch ratio:	\approx 0.6
Nitrogen pressure:	15-20 lb/in ²
Dope concentration:	7% (w/w) chitin, 8% (w/w) LiCl
Coagulants:	DMA/water, 75/25, v/v water \approx 0.1% aqueous acetic acid (pH 3.4) \approx 0.2% aqueous ammonia solution (pH 10.6) 15% Na ₂ SO ₄ in water Methanol
Filaments were washed in hot water at 75°C for 40 min, then in methanol for 20 min. and finally dried to constant weights at 60-65°C in an oven	
Coagulation bath length:	30cm except where otherwise indicated

approximately 5 cm. The weight and the height varied depending on the weight of each tube but it was important to be sure that the final weights of the tubes were approximately the same. The cotton-wool was used to absorb the liquid extracted from the fibres during centrifugation. Two small circles of filter paper cut (using a cork borer) to almost the same diameter as the tubes were then pushed down into each tube until they made contact with the cotton-wool. This was necessary to prevent any possible contamination of the samples with cotton-wool. At the completion of these preparatory procedures, the tubes were mounted on a rack and then taken to the spinning plant.

The extrusion was started and the freshly formed filaments were guided to the first roller of the first pair of advancing reels and passed around it with about five turns. This corresponded to about 1-2 g of spun filaments (the weight varied with spinneret hole number and size). The filaments were then gently unwrapped from the roller, cut to a size of about 2-3 cm using a sharp pair of scissors, then blotted between clean filter paper where necessary to remove excess liquid and introduced into one of the prepared tubes. The tube was then properly sealed with polyvinyl tapes, and the whole procedure was repeated for the rest of the tubes. Following various trials in which different times of centrifugation were used the final conditions were chosen. Samples were centrifuged at 2,000 rpm for 45 minutes using a centrifuge, manufactured by Baird and Tatlock (London). After centrifuging, the tubes were withdrawn one by one from the instrument and the samples introduced without delay into previously weighed weighing bottles fitted with covers. Up to this point it was not necessary to be careful about retaining every portion of the samples, as these had not yet been weighed, but they must not

be allowed to lose moisture to the atmosphere. The weighing bottles plus the samples were then weighed.

After this, the samples were removed and thoroughly washed in hot water at 75°C for 40 minutes using a magnetic stirrer and then washed in methanol at room temperature for 20 minutes. They were reintroduced into the bottles and then dried to constant weight in an oven at 70-80°C. The experiment was carried out for different bath conditions, coagulants, dope temperatures, spinneret hole sizes, bath lengths and for samples taken from different points along the spinning line. Details of the spinning conditions are listed in Table 6.1.

The gel swell factors were calculated using the relationship shown below:

$$\text{GSF} = \frac{\text{wt. of the partially coagulated fibre}}{\text{dry wt. of the fibre}}$$

Alternatively, the results could be expressed as:

$$\% \text{ liquid in fibre} = \frac{\text{GSF} - 1}{\text{GSF}} \times 100 \quad (6.1)$$

The relationship was further expressed as shown in Table 6.2 and Fig. 6.2 using arbitrary GSF values.

6.2.2 Measurement of the extrudate diameters

Using a 400 µm spinneret, the dope was spun into some selected coagulants. Part of the extrudate was carefully removed from the coagulation baths using a pair of tweezers and its diameter was immediately measured using a microscope fitted with a graticule. In each case, the other part of the extrudate was allowed to remain in the coagulation bath for 24 hours before measurement of its diameter.

TABLE 6.2: Relationship between GSF and percentage liquid in the partially coagulated fibres (Ref: equation 6.1)

GSF	% liquid in the fibre
1	0.00
1.5	33.33
2.0	50.33
3.0	66.67
4.0	75.00
5.0	80.00
6.0	83.33
7.0	85.71
8.0	87.50
9.0	88.89
10.0	90.00
11.0	90.91
12.0	91.67
13.0	92.31
14.0	92.86
15.0	93.33

FIG. 6.2: Relation of GSF to % liquid in fibre

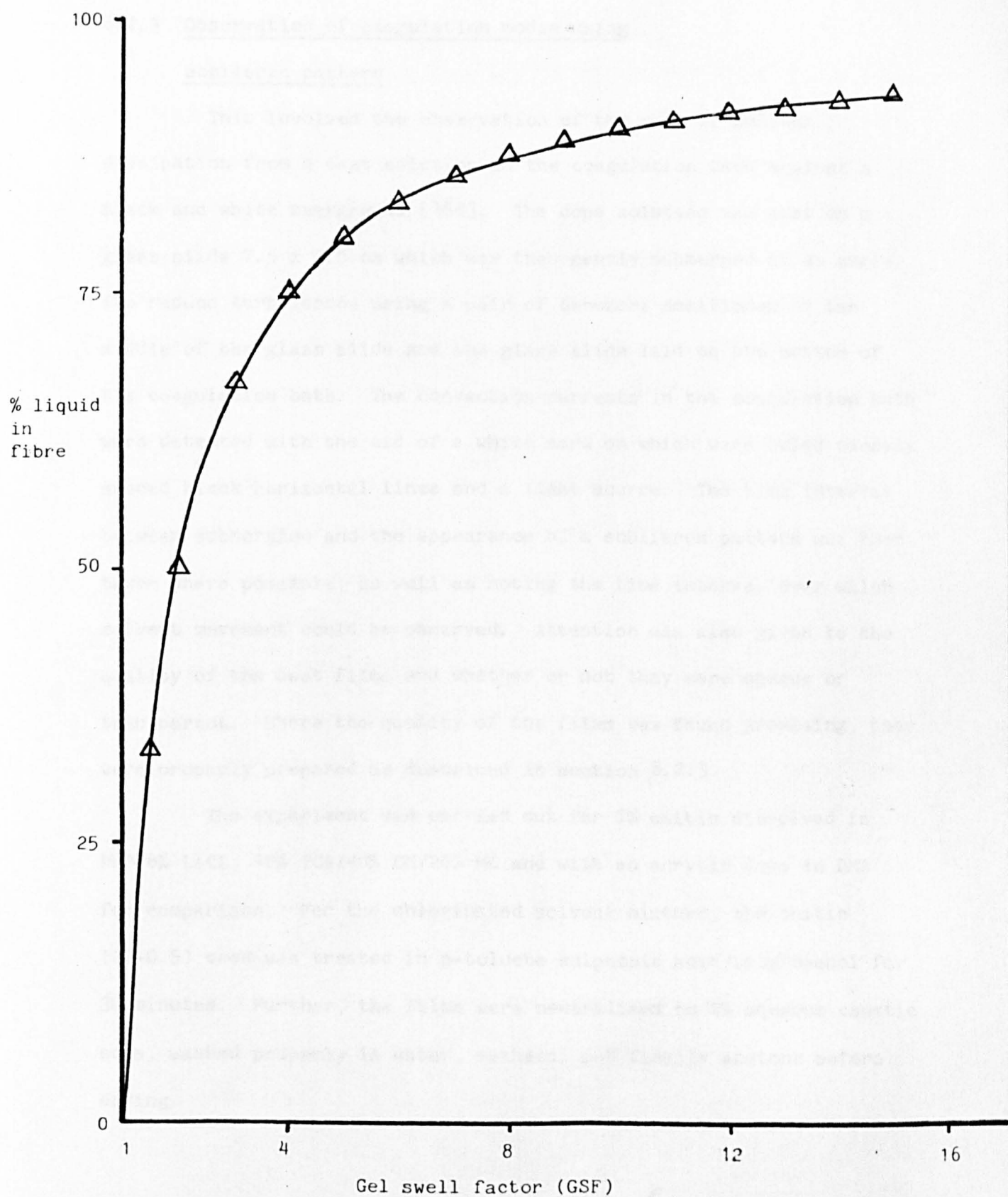

6.2.3 Observation of coagulation modes using schlieren pattern

This involved the observation of the mode of solvent dissipation from a cast solution in the coagulation bath against a black and white background [164]. The dope solution was cast on a glass slide 7.5 x 2.5 cm which was then gently submerged at an angle (to reduce turbulence) using a pair of tweezers positioned at the middle of the glass slide and the glass slide laid on the bottom of the coagulation bath. The convection currents in the coagulation bath were detected with the aid of a white card on which were ruled closely spaced black horizontal lines and a light source. The time interval between submersion and the appearance of a schlieren pattern was then taken where possible, as well as noting the time interval over which solvent movement could be observed. Attention was also given to the quality of the cast films and whether or not they were opaque or transparent. Where the quality of the films was found promising, they were properly prepared as described in section 8.2.3.

The experiment was carried out for 7% chitin dissolved in NMP-8% LiCl, 40% TCA/40% CH/20% MC and with an acrylic dope in DMA for comparison. For the chlorinated solvent mixture, the chitin (C2-0.5) used was treated in p-toluene sulphonic acid/isopropanol for 30 minutes. Further, the films were neutralised in 4% aqueous caustic soda, washed properly in water, methanol and finally acetone before drying.

6.3 Results and discussion

To start with, preliminary experiments were carried out to determine the best conditions for centrifuging which would leave only very small and fairly constant amounts of inter-filament liquid [173]. For this reason, samples spun from the same coagulant (water) were centrifuged at 2000 rpm for different times between 5 minutes and 60 minutes at about 15 minutes interval. The gel swell factors were calculated using equation 6.1 and the results obtained are shown in Table 6.3. It can be seen that almost constant GSF values were obtained after 45 minutes centrifuging. Based on this result, 45 minutes was selected as the most suitable period for centrifuging at 2000 rpm. (Although this time could have been reduced by increasing the centrifuge speed, this was not done due to strong vibration of the centrifuge at speeds above 2000 rpm.)

Table 6.4 shows the results obtained, and it can be seen that under the conditions indicated the GSF obtained varied between approximately 8 and 12.5 for all the coagulants. But an uncoagulated dope containing 7% by weight of chitin, 8% by weight of LiCl and 85% by weight of DMA, has an estimated GSF of 14.3, indicating that the degree of swelling after coagulation in each case was less than the original value. As earlier indicated, during coagulation one or a combination of the following three mechanisms takes place [164].

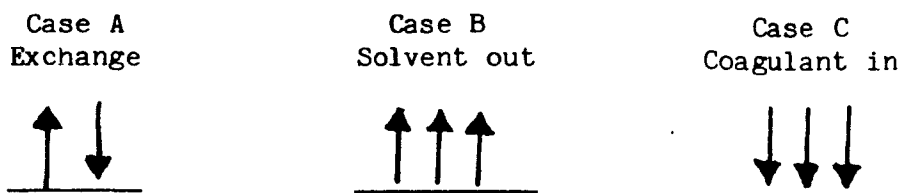

TABLE 6.3: Effect of time of centrifuging on GSF

Time of centrifuging (min)	GSF
5	10.27
15	9.00
30	8.50
45	7.40
60	7.30

Coagulant: Water

Centrifuging speed: 2000 rpm

TABLE 6.4: Effect of different coagulant on GSF at various coagulation bath temperatures

Coagulant	GSF at bath temperatures [†]		
	5°C	20°C	60°C
Water	7.9	8.2	9.1 7.0*
Water (pH 3.4)	7.6	7.9	9.6
Water (pH 10.6)	7.6	7.7	9.4
Aqueous Na ₂ SO ₄ (15%)	-	8.5	-
DMA/water, 75/25, v/v	11.2	10.8	12.5
Methanol	-	9.1	-

* coagulation bath length 120 cm

† mean of 4 values

Although it is difficult to interpret the results obtained and associate the coagulation behaviour with any of these mechanisms, it is apparent that while cases A and B may not result in swelling of the coagulates due to continued depletion of solvent, case C by contrast, will certainly promote high swelling of the coagulates. According to Paul [162] where the degree of swelling is less than the original value obtained for the uncoagulated solution, it indicates that the solvent loss by diffusion is greater than the nonsolvent gain. Thus, in his work on acrylic copolymer solutions in DMA (26% w/w) he showed that after coagulation in a 100% water bath, the degree of swelling (defined as the weight of liquid/unit weight of polymer) obtained was less than the original value of 2.85 for the uncoagulated solution again indicating that the DMA loss by diffusion was greater than the water gain. Calculated as GSF, this value would be 3.85. As the DMA content of the coagulation bath was increased from zero, the degree of swelling was observed to initially decrease slightly, then went through a minimum, and finally rose very steeply above the original value of 2.85 at between 85 and 90% DMA. In other words, from 85 to 90% DMA in the bath, the coagulation mechanism was predominantly that of case C. The high degree of swelling obtained in this region was interpreted to mean that the gel was actually being swollen by the bath. Generally, wet spun acrylic filaments leaving the coagulation bath will have a degree of swelling between 1 and 3 (GSF 2-4)[174].

Therefore, it is reasonable to presume that case A and/or B was the predominant mechanism in the coagulation of chitin-DMA/LiCl in all the coagulants examined. However, all the results obtained indicate that the efficiency of coagulation was relatively very poor. (Consider

that out of about 93% solvent in the threadline, only between 1 and 7% was extracted, depending on the coagulant.) If compared with a viscose solution (7% cellulose, 93% solvent) spun into an aqueous bath containing 8% H_2SO_4 , 14% Na_2SO_4 and 15% $ZnSO_4$ with GSF 2.6-3.2, depending on whether the solution contained a retardant such as benzyl trimethylammonium hydroxide or not [175], the problem of poor coagulation in spinning chitin solution becomes even more obvious. Consequently, in the case of chitin, it may be that only the peripheries of the threadlines coagulated efficiently, with a large core presumably uncoagulated. But the fact that such threadlines in most cases were able to be hauled-off and wound around the advancing reels suggests that the fibre skin must have been very strong. In fact, it was believed that in most cases, very tough impermeable outer skins were formed as soon as the threadlines came into contact with the baths and these controlled the rate of diffusion.

Comparison of the results obtained for 100% water with those of DMA/water, 75/25 indicated that water was a more efficient coagulant than the former, independent of the bath temperature. This is in agreement with the general view earlier expressed, that an increase of solvent in the bath reduces the driving force for diffusion and consequently the fluxes of solvent (outwards) and nonsolvent (inwards) [162,168]. On the whole, the GSF did not change much on going from 100% water to 75% DMA or 100% methanol. Addition of acid or alkali or salt also had little or no effect. This supports the results already obtained (chapter 3) which showed that the fibre properties were almost independent of the coagulation conditions. Although the GSF for methanol was very high, it was surprisingly observed that fibres spun

into methanol were much easier to handle and to dry than those spun using the other coagulants. The reason for this was not clear, but it must be associated with the rapid evaporation of methanol (or methanol/DMA) from the fibre.

While changes in bath temperature from 5°C to 20°C have almost no effect on GSF, it is obvious that the increase observed for those coagulants examined at 60°C was substantial. This is the opposite behaviour to that obtained by Paul [162] in his experiments on acrylic copolymers. Since increases in bath temperature generally result in faster rates of coagulation, the increase in GSF might have been the result of increased rate of nonsolvent influx into the threadlines or perhaps a more rapid skin formation. Such skin being presumably less permeable had entrapped more solvent in the core of the threadlines. Fibres produced were found to always have diameters greater than those spun at 5 or 20°C except for those spun into DMA/water, 75/25 at 5°C. These fibres had diameters slightly higher than those spun at 60°C.

Other methods of determining coagulation behaviour of polymer solutions were also examined. One was to observe the mode of solvent flow from a cast solution into various coagulants (section 6.2.3). Such observations depend mostly on the densities of the coagulant (ρ_c) and the solvent (ρ_s). Where $\rho_c > \rho_s$, the efflux will be easily detected as the solvent, being lighter, will tend to rise.

The results obtained are shown in Table 6.5. For all of the polymer solutions examined, the solvent flow (when it was observed) was always instantaneous once the film was submerged in the baths. But while very small variations were observed among the chitin solutions, the experiments showed very clearly some remarkable differences between

TABLE 6.5: Coagulation modes of casting solutions

Polymer concentration: PAN - 25% w/w
Chitin - 7% w/w

Polymer	Solvent	Coagulant	Mode/(end of continuous solvent flow time)	Film (wet) appearance and quality
PAN	DMA	Water	Slow flow (~8 min)	Opaque, very strong and elastic
"	"	Water(90 ⁰ C)	Rapid flow (~7 min)	Very opaque, strong and elastic
"	"	Methanol	Schlieren pattern was not detected	Slightly opaque, very strong and very elastic
Chitin	DMA or NMP/LiCl	Water	Rapid flow (~60 s)	Transparent, weak and inelastic
"	DMA/LiCl	Water(90 ⁰ C)	Very rapid flow (~10 s)	Very slightly opaque, slightly strong and inelastic
"	"	DMSO	Slow flow (3 min)	Transparent, weak and inelastic
"	"	Aqueous NA ₂ SO ₄ (15%)	Schlieren pattern was not detected	Transparent, weak and inelastic
"	"	Methanol	"	Transparent, strong and inelastic
Chitin	40% TCA/40% CH/20% MC	Water	Very slow flow	Opaque, very weak and sticky
	"	Methanol	Slow flow** (~80 s)	Transparent, fairly strong and inelastic

** About 5 s delay was observed before solvent flow

PAN polyacrylonitrile (copolymer Courtelle)

NMP N-methyl-2-pyrrolidinone

TCA trichloroacetic acid

CH chloral hydrate

MC methylene chloride

DMSO dimethyl sulphoxide

chitin/DMA-LiCl and PAN/DMA solutions. In the case of PAN/DMA, a slow but continuous flow of DMA from the cast layers could be observed in the water baths especially when hot water was used. On each occasion, DMA was noticed to flow upward from the surface of the layer and accumulate at the coagulant/air interface. The films were opaque but strong and extensible and were observed to shrink as soon as they were brought out of the coagulation bath. For chitin solutions cast in water baths, solvent efflux was always initially rapid, but gradually reduced and finally stopped mostly after about 60 seconds. Films produced were always transparent (except for chitin-40% TCA/40% CH/20% MC), weak, inextensible and did not appear to shrink at all when brought out of the baths. Although the solvent continued to diffuse out from the film for about 3 minutes when a chitin-DMA-LiCl solution was cast in DMSO, the films obtained had similar properties to those cast in water. In all the cases, including PAN/DMA solutions, schlieren patterns could not be observed when methanol was used, except when the cast layers were moved in the bath. Indeed, a schlieren pattern was easily detected with all the coagulants when the cast layers were slowly moved around in the baths or when the baths were stirred. The lack of schlieren patterns with some of the coagulants was associated mostly with their low densities.

Although the results show that the method provides quite an easy way of observing dope coagulation in a static system, it is difficult to relate these results to a specific coagulation mechanism. However, where no solvent flow could be detected by schlieren pattern (except when the bath was stirred), the coagulation mechanism, according to Cabasso [164], could be that of solvent-nonsolvent exchange (case A).

This was explained on the basis of the differences in the densities of the polymer (ρ_p), solvent (ρ_s) and coagulant (ρ_c). Cabasso argued that if $\rho_p = \rho_s = \rho_c$ and if the heat of mixing (ΔH^m) and hydrostatic pressure of the coagulant above the nascent solid phase are minimal, then the exchange mechanism can be considered as a pure diffusion problem. Because it is rare to have the three densities equal, it may mean that this ideal situation does not exist in any system. However, he showed that where this kind of coagulation mechanism occurred (as in the coagulation in water of polysulphone dissolved in dioxane), the membranes produced were always porous in structure. Based on this argument, one could certainly rule out the exchange mechanism as being dominant in the coagulation of chitin-DMA/LiCl solutions, due to the absence of macrovoids in chitin fibres. But such an explanation might be an oversimplification of the coagulation process. As for the situation where the solvent flow was instantaneous, followed by a rapid accumulation of the solvent on the surface of the coagulation bath, Cabasso claimed that the coagulation mechanism was that of case B, since the depletion and removal of the solvent from the cast layer interface was via convection (rather than diffusive exchange with nonsolvents). This system, he observed, produced dense membrane structures (as with the coagulation in water of either polysulphone or cellulose acetate dissolved in tetrahydrofuran (THF); densities, g/cm³: polysulphone 1.24, cellulose acetate 1.3, dioxane 1.03, THF 0.89, acetone 0.79 and water 1). Therefore, this mechanism would be applicable to PAN/DMA solutions coagulated in water as a continuous solvent flow was observed. Incidentally, this suggestion appears to agree with an earlier one by Paul [162]. It might seem likely that the coagulation of chitin

solutions was in two stages. The first stage involved a very rapid but short efflux of solvent (case B). In the second stage, no solvent efflux was observed presumably as a result of skin formation. According to Epstein and Rosenthal [176], the coagulation process can be modified by the presence of precipitated polymer at the fibre surface which might be more permeable to one liquid than the other. They argued that a high rate of nonsolvent influx will only occur if the vapour pressure of the nonsolvent is very much larger than that of the solvent, as in the coagulation in water of high-melting polyamides dissolved in sulphuric acid. Epstein and Rosenthal noted that the vapour pressure, in this case, was so large that the surface skin was not strong enough to prevent water from penetrating the dope. In the present system, there was no indication of any preferential permeability after the first stage of coagulation. However, it was almost certain that the difference in vapour pressure between the nonsolvents and the solvent was not large enough to force the nonsolvents into the dope, otherwise the gel swell factor values earlier obtained would have been more than the theoretical value for uncoagulated dope. Therefore, it seemed likely that the solvent became trapped after the first stage of coagulation.

This proposition became even more obvious as a result of experiments in which droplets of PAN/DMA or chitin-DMA/LiCl solution were coagulated separately in a water or methanol bath. While it took about 16 minutes for a droplet (diameter ~ 1 cm) of PAN/DMA solution to coagulate in water, a similar size drop cast in methanol always took about 12 minutes. In each case, however, the fully coagulated droplets were very hard and could not be crushed by hand, indicating

total coagulation. The experiments, when repeated for chitin solutions using a similar size of droplet and a cast time of about 16 minutes, showed that less than half of the droplets from both baths had coagulated. In each case, the uncoagulated portion appeared to have the same composition as the original dope, while the coagulated portions were weak and were easily crushed by hand. This further proved that coagulation of chitin solution was a very slow process and might involve an uncoagulated core whose composition would be the same as the dope. Although the composition of the coagulated phase was not known, it was presumed to contain both the solvent and the coagulant [162] as no shrinkage of the droplets was observed during coagulation. Indeed, in another experiment carried out to find out if deswelling of filaments occurred during storage in coagulation baths, it was found that filaments spun into methanol or water or aqueous Na_2SO_4 (15%) baths neither deswelled nor swelled within the 24 hour period they were kept in the baths. However, it was noticed that the wet filaments were always about 15% greater in diameter than the hole size of the spinneret used, presumably due to the elastic character of the polymer solution [177].

Perhaps the poor coagulation behaviour exhibited by chitin solution may be related to the complex formation between the solvent (DMA/LiCl) and chitin, proposed by many workers [178-181] as being responsible for the dissolution of chitin. To start with, it is claimed that an interaction occurs between a LiCl ion-pair and DMA through the carbonyl group to form a weak electrolyte intermolecular complex [178, 179]. Solvation of the chitin is through the interaction of one LiCl ion-pair with intermolecularly hydrogen bonded hydroxyl and acetamide

groups, resulting in the destruction of the strong intermolecular hydrogen bonds in the polymer. The polymer then swells and finally dissolves in the solvent. However, the intramolecular hydrogen bond between the OH^3 and the ring oxygen atom ($\text{O}^{5'}$) on the next N-acetyl-D-glucosamine unit (section 1.3) is unaffected by the dissolution mechanism. This implies that the bond ($\text{OH}^3 \dots \text{O}^{5'}$) remains undisrupted even when the polymer is in solution, resulting in a relatively rigid ribbon-like structure. The resulting structure is illustrated below [178].

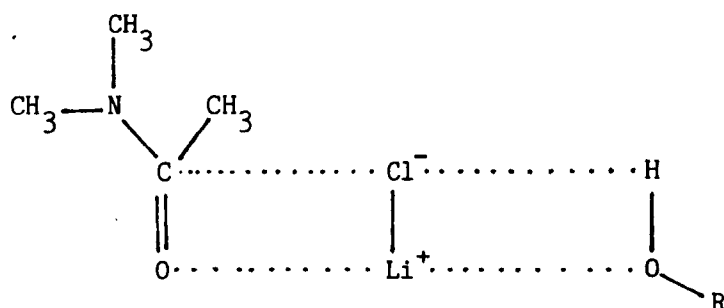

The implication of this proposal is that not only could this complex formation result in poor coagulation as a result of ineffective removal of the solvent, but also lead to the poor drawability of the fibres.

Therefore, to remove the solvent from the fibre, a much more elaborate coagulation bath and/or vigorous washing operations are required. Consequently, the use of a long coagulation bath (120 cm) can be seen as an advantage as the GSF appears to have been reduced from about 9 to about 7 for fibres spun into a water bath at 60°C (Table 6.4). Further, satisfactory fibres suitable for drying on the machine as with acrylic fibres can only be obtained by a subsequent washing process. This reduces the GSF, as can be seen in Table 6.6. The samples shown were obtained at different processing stages after washing

TABLE 6.6: Effect of different washing treatments
on GSF

Washing treatments	GSF	Fibre diameter (μm)	Breaking load (g)	Extensibility (%)
A	6.3	65	22.7	46.1
B	3.0	60	27.0	40.0
C	5.4	59	27.5	43.9
D	1.9	57	30.3	31.6

A - None. Filaments collected manually after 5 turns on the first advancing reel at the spin bath exit, then GSF determined as indicated in section 6.2.1.

B - As in 'A' but 1 turn on the first advancing reel, 5 turns on the 2nd where the fibres were washed in methanol before GSF determination.

C - 1 turn each on the first pair of advancing reels; then passed through a hot water bath ($80-85^{\circ}\text{C}$), and manually collected after 5 turns on the 1st draw roller before GSF determination.

D - As in C but washed in methanol positioned under the second roller of the draw rollers.

Spinning conditions: as listed in Table 6.1
Coagulant: water (pH 3.4); bath length 120 cm

in hot water or methanol or in hot water followed by methanol. The results show that the amount of liquid in the filaments was reduced after each washing stage and very much more when methanol was used soon after the hot water wash. The rate of drying of the filaments also increased as the GSF decreased. The fibre properties were similar to those earlier reported on the effect of washing (section 3.2.2.2).

Table 6.7 shows the effect of spinneret hole size on GSF at various jet stretch ratios, using the DJWS technique. The results appear to indicate that GSF decreases with (i) increase in jet stretch ratio, and (ii) decrease in spinneret hole size. A comparison of GSF values obtained for the 150 μm diameter spinneret at jet stretch ratio of 0.85 with the value shown for sample A (Table 6.6) indicates that under similar conditions, the difference between wet spinning and dry-jet wet-spinning was negligible.

The coagulation behaviour in the spinning of chitin fibres from the DMA/LiCl system can be therefore summarised as follows:

- (i) In comparison with the coagulation of acrylic or viscose rayon spinning solutions, the coagulation of chitin solutions in DMA-LiCl appears to be a very slow process. A detailed determination of the gel swell factor (GSF) carried out under various spinning conditions, showed that GSF varied between 6 and 12.5 approximately (compare with acrylic and viscose rayon systems where GSF were 1-2 and 2.6-3.2 respectively).
- (ii) Further evidence for the slow coagulation was provided by the non-opacity of the fibres spun into various coagulants under different conditions, and the apparently non-porous structure obtained independent of spinning conditions.
- (iii) However, it was found that after washing in a methanol bath

TABLE 6.7: Effect of spinneret hole size on GSF at various jet stretch ratios using the DJWS technique

Spinneret hole size (μm)	GSF ⁺ at jet stretch ratios of	
	0.85	6
150	6.6	5.3*
300	7.3	5.5
400	7.5	6.2

* Jet stretch ratio 2.87

+ GSF at bath exit

Spinning conditions: Coagulant - water (pH 3.4)
 Bath temperature: 20°C
 Air gap: 1.5 cm
 Dope concentration: 7% (w/w) chitin,
 8% (w/w) LiCl
 Chitin: C2-2
 Bath length: 120 cm

alone or successively in hot water and methanol baths, GSF values between 2 and 3 were obtained. Other methods used to reduce the GSF values included the use of a longer coagulation bath (120 cm), spinnerets with small hole diameters and an increase in jet stretch ratio (mainly for DJWS).

(iv) Although it was not possible to establish fully the coagulation mechanism, it was indicated that this might involve a two stage process: firstly, a rapid but short efflux of solvent from the dope which led presumably to skin formation at the fibre surface. Secondly, as a result the coagulation process became stagnant or considerably reduced, locking the solvent into the core of the fibres. As a whole, the coagulation mechanism was presumed to be predominantly that of case B (ie. involving mostly solvent efflux) as no porous structure was obtained to indicate rapid coagulation resulting from influx of nonsolvent.

CHAPTER 7

THE DEVELOPMENT OF A SPINNING SYSTEM

FOR THE PRODUCTION OF CHITIN FIBRES

7.1 Introduction

In the preliminary attempts to spin chitin fibres, the process of spinning was based on the procedure used for wet spinning acrylic fibres from DMF or DMA [113]. After coagulation, the filaments were taken around the take-up rollers with up to fifteen turns where they were successively washed in hot and/or cold water, and finally in methanol. After these operations, it became almost impossible to draw the fibres. Where drawing was possible, it never exceeded ~12% and the fibres then had very low extensibilities (7-9%) and only slight increases in their tenacity values. On the other hand, fibres that were not drawn but dried in a relaxed state in the oven or in air, had extensibilities of between 30 and 45%. But it was also shown that such fibres, when dried under tension, further lost their extensibilities to lie between 15 and 30%, depending on the coagulant. Surprisingly, fibres that were wound only twice on the first roller of the advancing reels without washing and which were centrifuged and dried in air, were found to have extensibilities of about 78%. It was then presumed that winding the filaments around the advancing reels and washing and/or drying under tension were effectively stretching operations, indicating that the partially coagulated chitin fibres were extremely sensitive to tension. Therefore, whereas it is possible to wash acrylic fibres extensively before drawing, in the case of the chitin, the winding of the filaments on the roller for washing led to such shrinkage that drawing was hardly possible. Consequently, it became necessary to reduce the number of wraps on the reels and thereafter find methods (if possible) by which the fibres could be drawn. However, it was considered necessary to first establish that wrapping the freshly coagulated

fibres around the advancing reels with or without washing, causes the loss of extensibility.

7.2 Experimental

7.2.1 Hydrolysis of chitin

For samples 7-1 to 7-6, the chitin flakes (C2) were hydrolysed using the usual TSA/IP treatment (section 2.2.10). However, for the other samples (7-7 to 7-101), the flakes were first treated in caustic soda (1 N) for 24 hours, and washed several times with distilled water until neutral, then twice in isopropanol before treating in TSA/IP. The rest of the treatments were as described in section 2.2.10 except that no final NaOH washing was carried out.

7.2.2 Preparation of fibres

The procedures for dissolving the polymer and for spinning were essentially the same as were described in section 2.4.1 and 2.4.4 respectively. However, the number of times the fibres were passed around the pairs of advancing reels was varied to increase or reduce the time the fibres were under tension. The spinning conditions are listed in Tables 7.1, 7.5 and 7.15.

7.3 Results and discussion

7.3.1 Effect of tension on partially coagulated chitin fibres

Table 7.2 shows the effect of tensioning the filaments using only the first pair of advancing reels in the spinning process. The fibres were spun into three different coagulants and the number of turns the fibres were passed around the reels was varied. Thus, fibres were .

TABLE 7.1: Spinning conditions for samples 7.1-7.6

Fixed conditions

Chitin:	C2-2 except where otherwise indicated
Dope:	aged for 7 days
Pump speed:	3 rpm
Pump capacity:	1 cc/rev
Spinneret size:	80 μm , 20 hole except where otherwise indicated
Linear rate of extrusion:	29.8 m/min
First advancing reel speed:	25.3 m/min except where otherwise indicated
Jet stretch ratio:	0.85
Nitrogen pressure:	15-20 lb/in ²
Dope concentration:	7% (w/w) chitin; 8% (w/w) LiCl
Coagulants:	DMA/water 75/25 v/v; water; water (pH 3.4); water (pH 10.6) methanol
Coagulation bath length:	120 cm

Variable conditions

Number of turns the filaments were passed around the advancing reels

TABLE 7.2: Effect of tensioning the filaments on the first pair of advancing reels on the properties of undrawn fibres

Sample No.	Coagulant	No. of turns of filaments on each reel	Fibre diameter (μm)	Fibre count (dtex)	Tenacity T (g/dtex)	Extensibility E (%)	Tensile factor $TE^{\frac{1}{2}}$
7-1	DMA/H ₂ O 75/25, v/v	Nil	36.5	14.5	0.43	71.3	3.63
7-2		20	24.0	6.0	0.76	20.0	3.40
7-3	Methanol	Nil	30.0	9.8	0.78	56.0	5.84
7-4		20	25.0	6.8	1.00	21.7	4.66
7-5	Water	Nil	35.0	13.4	0.61	52.0	4.40
7-6		20	27.5	8.3	0.73	28.0	3.86

Spinning conditions: Dope temperature 60°C
 As given in Table 7.1, but only the first pair of advancing reels were used. All the samples were stored in coagulant for 24 hours before drying in a vacuum oven for 24 hours.

spun (i) with no turns (no tension) on either of the first pair of advancing reels,

and (ii) with twenty turns (tensioned) on each of the advancing reels. In each case, the samples were collected and stored in their respective coagulants for 24 hours. At the end of this period, the coagulants were drained off by suction and samples dried under vacuum at room temperature overnight. As usual in the samples that had no methanol wash at all, the filaments were stuck together after drying. (It was necessary for the yarns to be carefully separated into individual filaments before testing.) For all the coagulants examined, the data show that the filaments are highly susceptible to stretching when they are passed around the reels as soon as they emerge from the coagulation bath. This stretching effect increases the tenacity of the fibres. However, the decrease in extensibility and in tensile factor indicates that this kind of stretching leads to poor fibre toughness. For those samples spun without tension, the values of the extensibility are higher than any other sample previously spun as well as possessing tenacities between 0.43 and 0.78 g/dtex. It was noted that the fibres spun into DMA/water (75/25, v/v) bath without tension were about 15-20% higher in extensibility than fibres spun into the methanol and water baths, but with a slightly higher fibre diameter and lower tenacity. The explanation for this could be that DMA/water is not an effective washing agent, at least not at the composition examined, even after storing for 24 hours. However, the value of the tenacity obtained indicates that storing for 24 hours in DMA/water was much better than not washing at all (tenacity 0.25 g/dtex, extensibility 78%, section 3.2.2.2). The bigger diameter obtained obviously indicates that the fibres were more

swollen when spun into DMA/water than into the other two coagulants; (a similar conclusion was reached on the GSF studies, chapter 6). The largest decrease in diameter on wrapping also occurs in the DMA/water mixture, implying that this fibre was also the more easily deformable sample. Under the same tensioning conditions, the fibres from the DMA/water bath thus had the smallest diameter. It is also clear that the effect of winding was less on the fibres spun into water as they had a higher diameter and extensibility.

The effects of tension on fibre properties described above were obtained also from winding wet fibres on a bobbin.

Effect of relaxing the fibres in a second coagulation bath containing hot water

In section 3.2.2.2, it was indicated that washing generally improved the fibre properties. Thus, as shown above, fibres spun using 75% DMA bath were very weak presumably due to ineffective washing. Therefore, it was considered reasonable to extend the experiment to include a washing bath. After several trial arrangements, Fig. 7.1 shows the arrangement of the spinning line finally adopted. The spinning line had two coagulation baths; the first bath (4) contained the coagulant and the second (7) hot water at 80-85°C. Filaments were spun into the first coagulation bath, withdrawn and passed around the first pair of advancing reels. They were then allowed to fall freely into the second coagulation bath (7) which was placed between the two pairs of advancing reels in the manner shown in Fig. 7.1. The surface speed of both pairs of reels were set such as to allow the filaments to accumulate when necessary in bath (7). The speed of the

FIG. 7.1: Method for relaxing chitin fibres

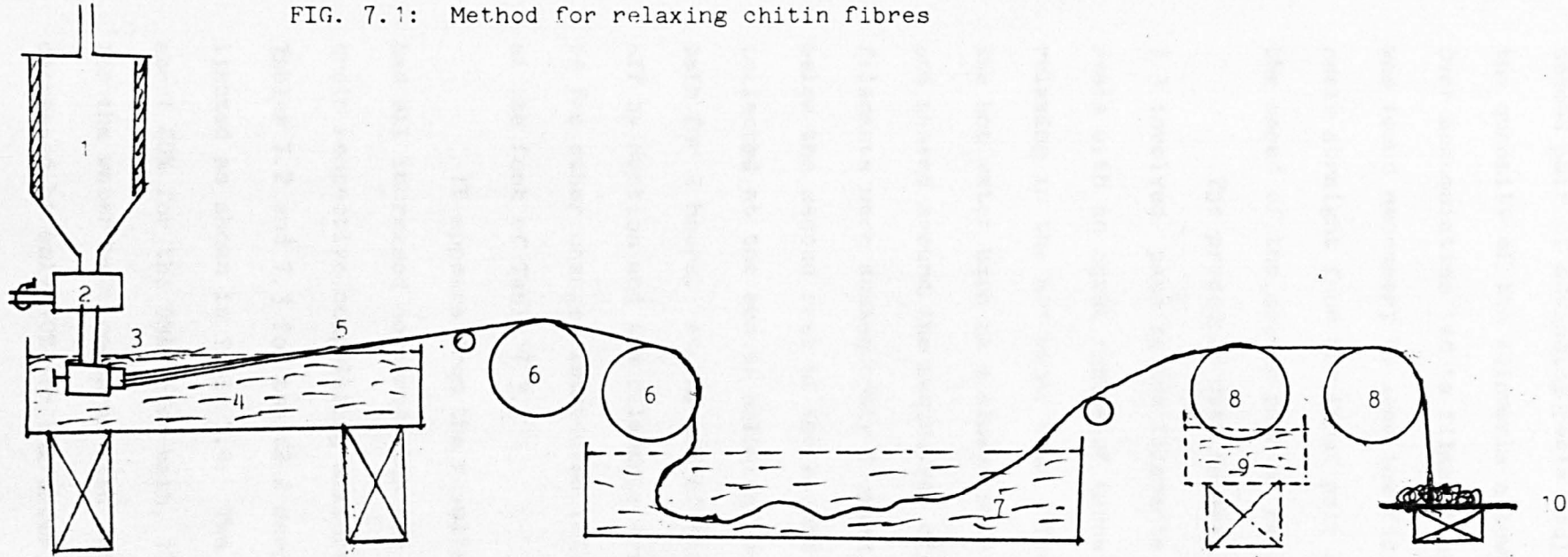

- 1. Dope reservoir
- 2. Spinning block and metering pump
- 3. Spinneret
- 4. 1st coagulation bath

- 5. Highly swollen filaments
- 6. 1st pair of advancing reels
- 7. 2nd coagulation bath (hot water at 80-85°C)
- 8. 2nd pair of advancing reels

- 9. Washing bath (optional)
- 10. Glass plate

second pair of advancing reels could then be adjusted to control the quantity of the filaments allowed to accumulate in the bath. Over accumulation led to filament entanglement and breakages. It was found necessary to lead the filaments first to the second advancing reels straight from the first pair and then slowly reduce or increase the speed of the second pair of reels as the case may be.

The procedure used in preparing the samples shown in Table 7.3 involved passing the filaments around the first pair of advancing reels with an equal number of turns (between 0 and 5), followed by relaxing in the hot water bath. The filaments were then removed from the hot water bath at a slower rate than they were delivered into it, and passed around the second set of reels also with 0-5 turns. The filaments were subsequently dropped onto a clean glass plate placed below the second reel of the second pair of advancing reels, and collected at the end of spinning when they were stored in a methanol bath for 2 hours. At the end of this period, the methanol was drained off by suction and the filaments dried in a vacuum oven overnight. (A few other changes introduced into the spinning conditions are shown at the foot of Table 7.3.)

It appears from the results obtained that the tenacity values had all increased compared with the samples given only a relaxation in their respective coagulating mixture (Table 7.2). Taking the data from Tables 7.2 and 7.3 for the C2-2 sample allows this effect to be highlighted as shown in Table 7.4. The tenacity values had increased by about 80% for the DMA/water bath, 17% for the methanol bath and 34% for the water bath, compared with the extensibility values which had decreased by only 10% for DMA/water, increased by 12% for methanol and

TABLE 7.3: Effect of relaxing the fibres in a hot water bath

Sample No.	Coagulant	No. of turns on the reels	Fibre diameter (μm)	Fibre count (dtex)	Tenacity T (g/dtex)	Extensibility E (%)	Tensile factor $\text{TE}^{\frac{1}{2}}$
7-7	DMA/water 75/25, v/v	Nil	35.7	14.0	0.78	64.0	6.24
7-8		Nil*	37.0	16.0	0.80	58.4	5.43
7-9		Nil**	36.5	14.8	0.74	60.8	5.77
7-10		1	34.5	12.8	0.84	51.2	6.00
7-11		5	28.0	8.5	0.96	30.0	5.26
7-12	Methanol	Nil	30.5	9.8	0.92	65.0	7.42
7-13		Nil*	32.5	10.5	0.88	58.0	6.70
7-14		Nil**	29.8	9.5	0.78	60.5	6.07
7-15		1	29.3	9.0	0.98	54.0	7.20
7-16	Water	Nil	32.5	11.5	0.82	51.0	5.86
7-18		1	31.4	10.9	0.92	48.5	6.40
7-19	Water (pH 3.4)	Nil	31.2	10.8	0.90	50.0	6.36
7-20		1	30.0	9.7	0.96	48.0	6.65
7-21	Water (pH 10.6)	Nil	32.5	11.5	0.90	53.0	6.60
7-22		1	31.0	10.5	0.94	47.4	6.47

* C2-0.5 (dope at 60°C)

** C2-6; Unstarred C2-2

Spinning conditions: Take-up rollers: 25.3 m/min; Draw rollers: 14 m/min

Jet stretch ratio: 0.78

Dope temperature: 25°C

Hot water bath: 80-85°C

Other spinning conditions were as shown in Table 7.1

TABLE 7.4: Effect of relaxation of partially coagulated undrawn chitin fibre (data from Tables 7.2 and 7.3)

Sample No.	Coagulant	Relaxing in respective coagulant			Relaxing in hot water (80-85°C)		
		T (g/dtex)	E (%)	$TE^{\frac{1}{2}}$	T (g/dtex)	E (%)	$TE^{\frac{1}{2}}$
7-1; 7-7	DMA/water 75/25	0.43	71.3	3.63	0.78	64.0	6.24
7-3; 7-12	Methanol	0.78	56.0	5.84	0.92	65.0	7.42
7-5; 7-16	Water	0.61	52.0	4.40	0.82	51.0	5.86

remained almost unchanged for the water bath. These results have generally increased the tensile factor of the fibres. All the samples produced could be knotted without breaking easily. In some cases breakage occurred but only from an imperfect position on the filaments instead of the knotted points. These results are interesting because for the first time, it was possible to increase fibre tenacity without substantially reducing the extensibility. The reason for this improvement is not clear, but it was very noticeable in spinning that the hot water treatment had a toughening effect on the fibres. If the hot water treatment gives a stronger skin, it may reduce the mechanical damage which normally occurred during further winding and handling. Furthermore, relaxing in hot water, followed by storing in methanol for 2 hours was in every sense similar to washing successively in hot water and methanol (tenacity 0.90-1.12 g/dtex; extensibility 37-44%, section 3.2.2.2, Table 3.6).

Although the usual effect of wrapping the partially coagulated filaments on the reels was observed, it appeared that one wrap on each reel and treating as described above produced better fibres as the values of extensibilities were reduced (for all the coagulants examined) by no more than ~10%. However, the fibre properties obtained by passing the fibres around the reels with five turns were only slightly different from the results previously obtained with twenty turns (Table 7.2) indicating that there is perhaps a maximum number of turns above which no further decrease in extensibility would be observed. What these results appear to have indicated is a method for producing highly extensible undrawn chitin fibres, and it appears that this can be done using any of the coagulants studied. The amount of extensibility

required in the final yarn can be controlled by controlling the number of wraps on the rollers before relaxing in a hot water bath and storing in methanol. However, such fibres were observed to be easily stretched and when once stretched above 10% of the original length, no recovery was observed.

Incidentally, the starred samples (Table 7.3) were spun using chitin samples hydrolysed for 30 minutes (C2-0.5) and 6 hours (C2-6). They are included briefly to show the effect of time of hydrolysis on fibre properties. Apart from the dope temperature of 60°C used for spinning the C2-0.5 sample, the rest of the spinning conditions are the same as for the other samples. It was necessary to heat up this dope because of the higher viscosity (80 Pas). However, prolonged heating at temperatures above 40°C tended to gel the dope. Once the dope was properly degassed, spinning usually took about 4 hours and no problem was encountered with dope at 60°C for this period. The data obtained for the mechanical properties of the fibres suggest that changes in the time of treatment do not appear to affect these properties. (Earlier, (section 4.1.7) it was shown that beyond 30 minutes hydrolysis the viscosity of the dopes made from chitins with various treatment times appeared to be very similar. Similarly, the acetyl content (section 4.1.4) was also observed to be little affected by the variations in the hydrolysis time.

7.3.2 Electron micrographs and X-ray diffraction patterns of undrawn relaxed chitin fibres

Plates 7.2 to 7.7 show the electron micrographs of the undrawn fibres, relaxed in hot water. The micrographs were obtained from the

PLATES 7.1-7.3: Surface texture and cross-section of undrawn filaments, relaxed in hot water
(Coagulant: 75% DMA)

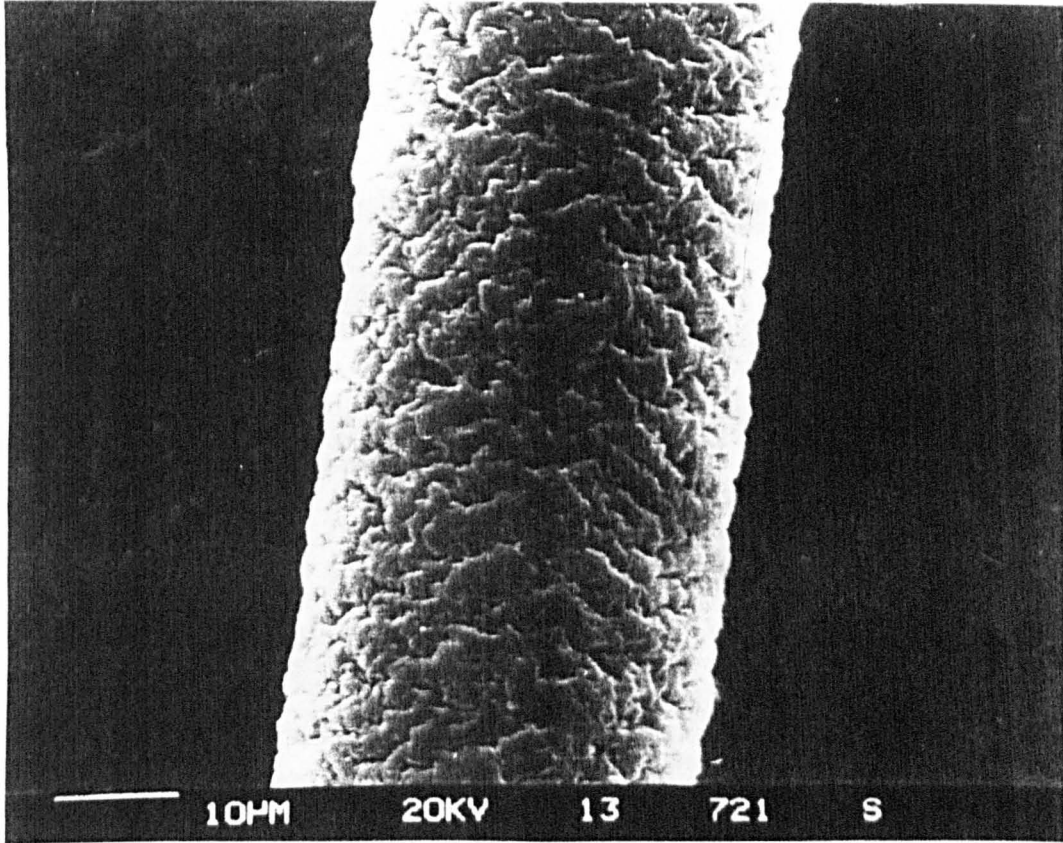

Plate 7.1

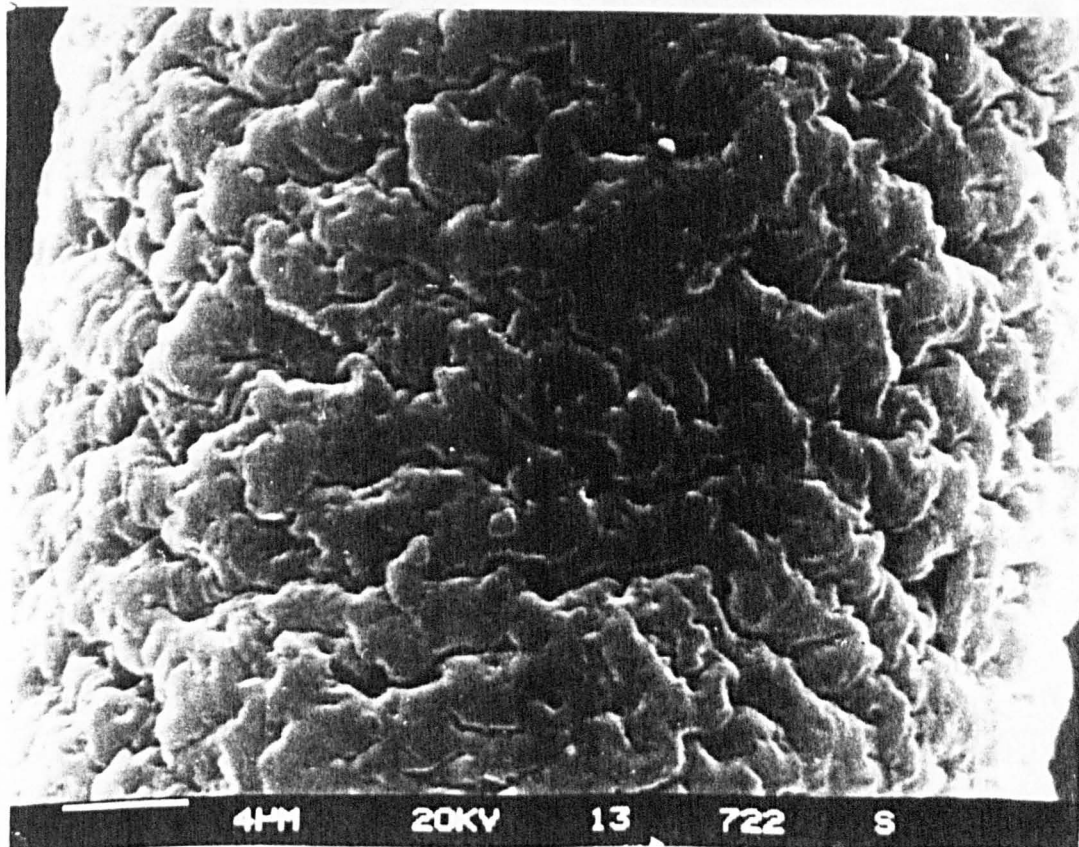

Plate 7.2

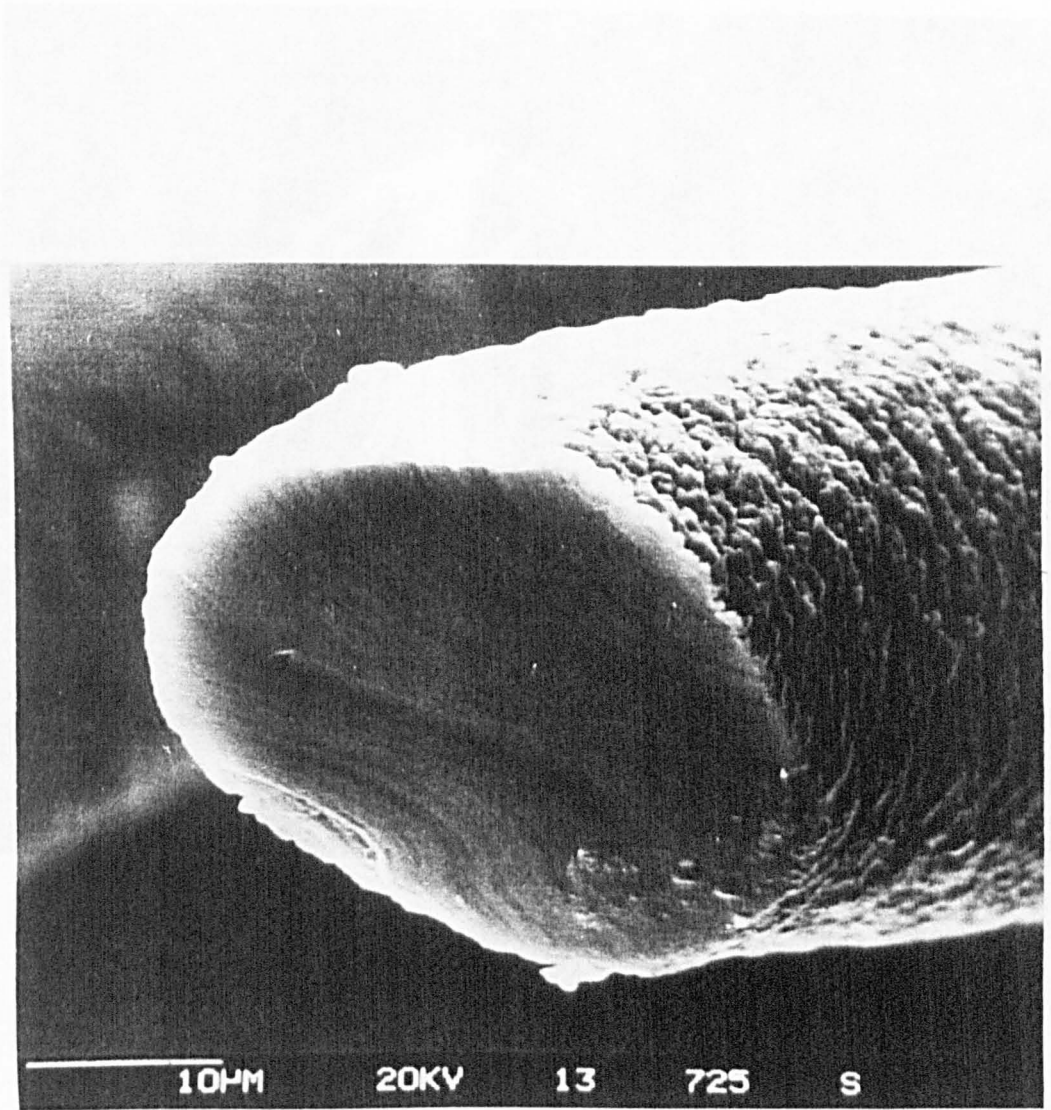

Plate 7.3

PLATES 7.4 and 7.5: Surface texture and cross-section of undrawn filaments, relaxed in hot water (Coagulant: water)

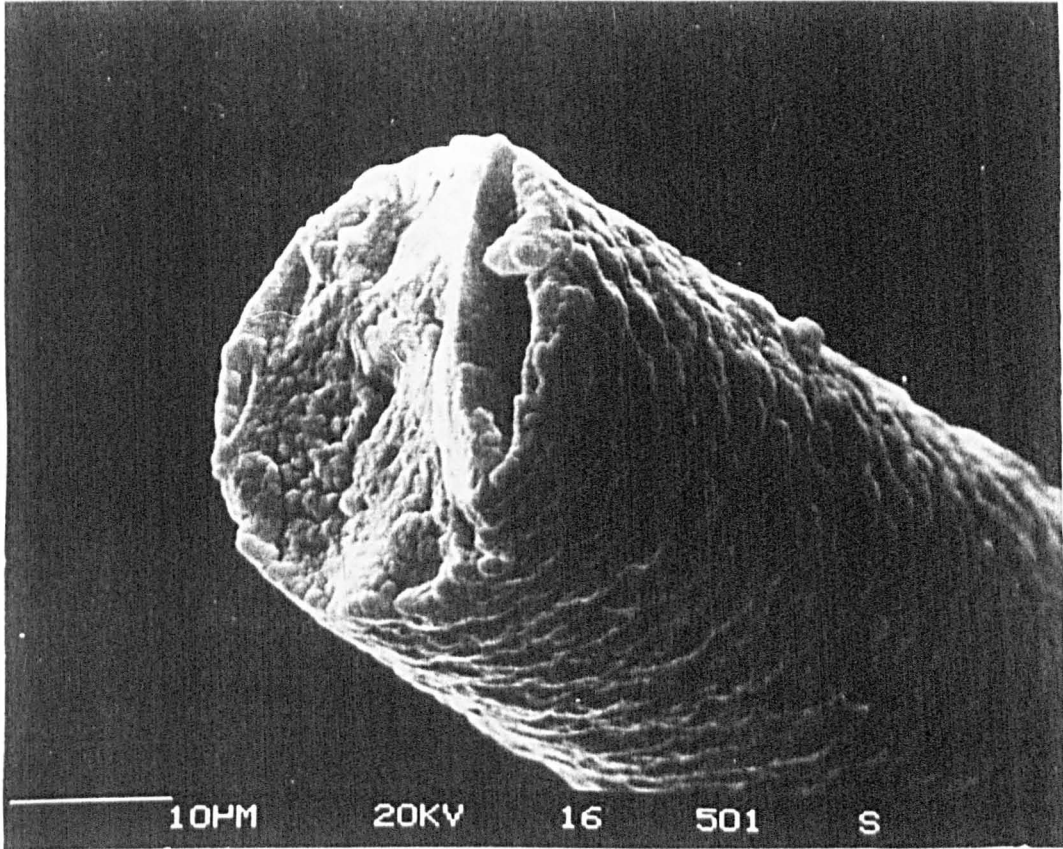

Plate 7.4



Plate 7.5

PLATES 7.6 and 7.7: Surface texture and cross-section of undrawn filaments, relaxed in hot water (Coagulant: methanol)

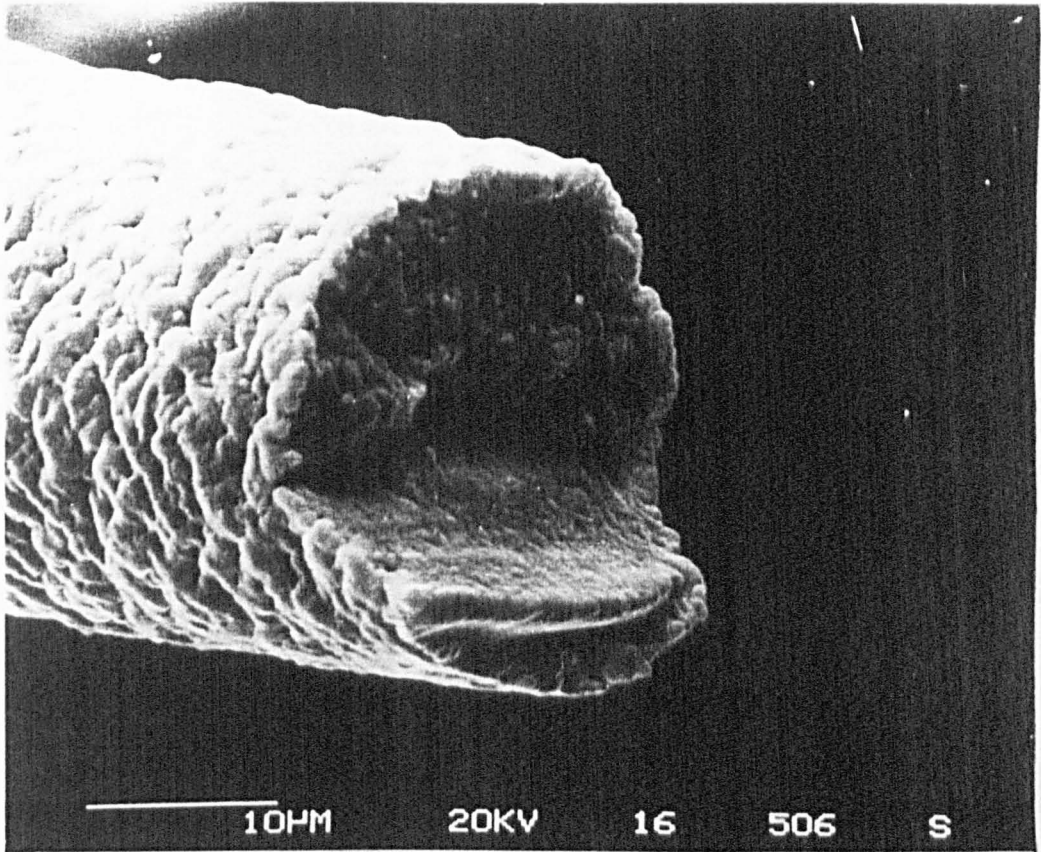

Plate 7.6

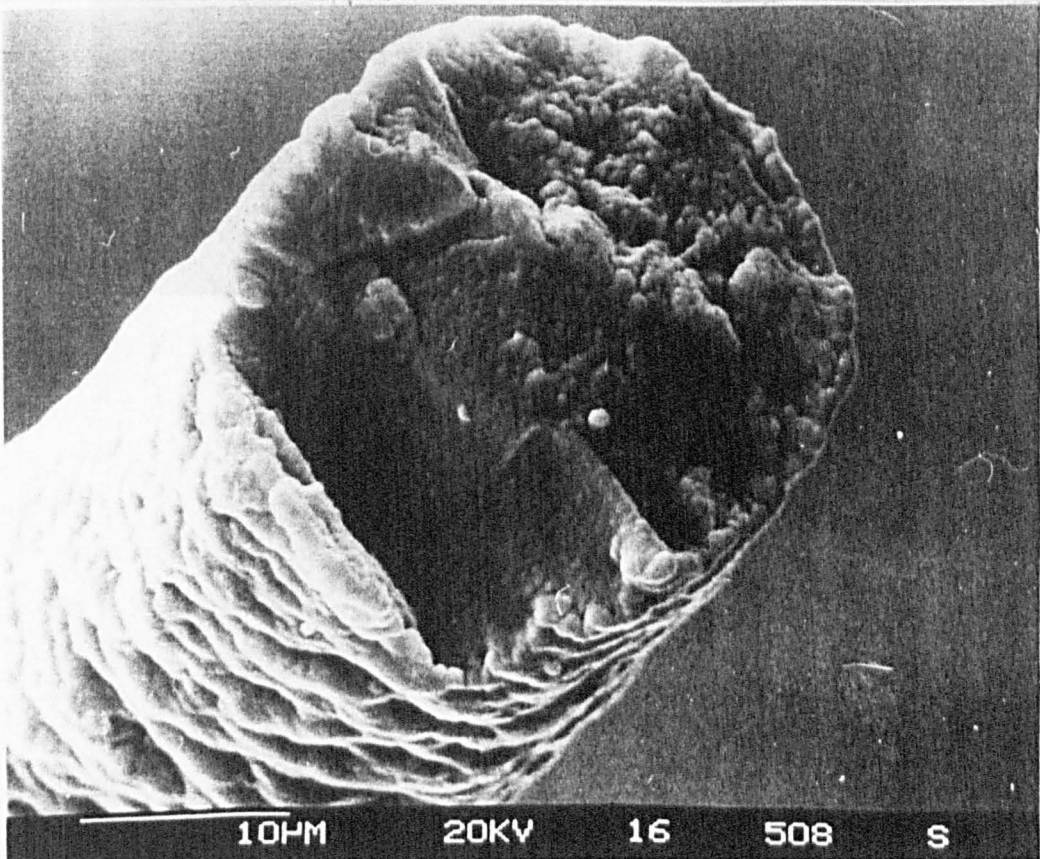
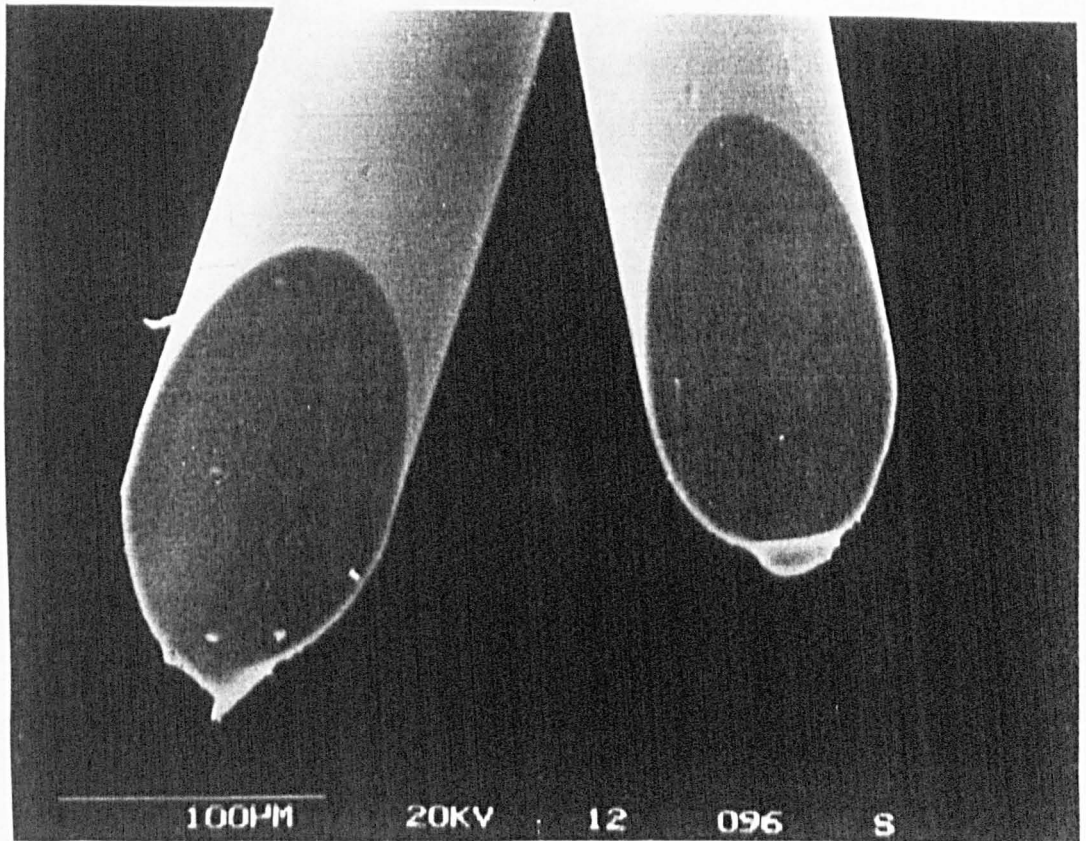

Plate 7.7

PLATE 7.8: Electron micrograph of undrawn
DJWS filaments
(Coagulant: water; jet stretch ratio 0.85)



PLATES: 7.9 and 7.10: X-ray diffraction patterns of undrawn filaments

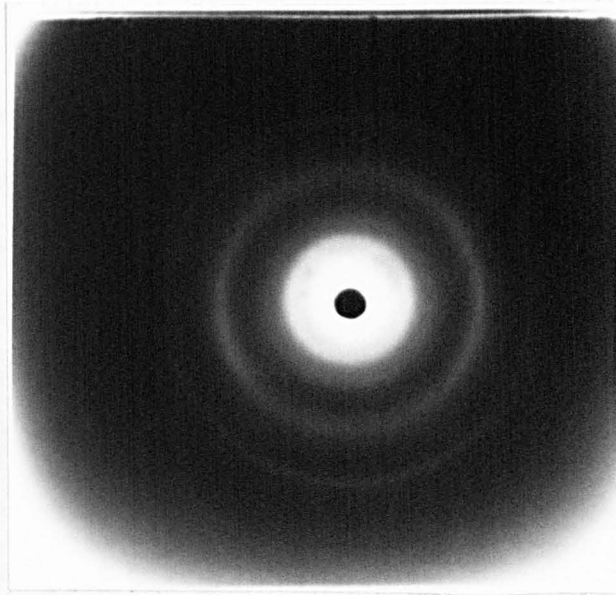

Plate 7.9

Coagulant: 75% DMA

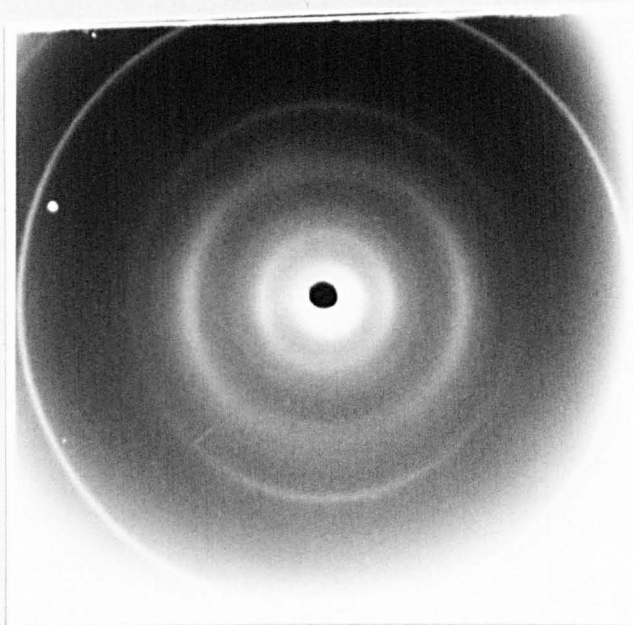

Plate 7.10

Coagulant: methanol

scanning electron microscope at the magnifications indicated. It can be clearly seen that the surfaces have the peculiar characteristics earlier observed except that they appear to contain even more pronounced if fewer irregular furrows which appear like deep cracks all over the surfaces. As was indicated, such surface characteristics were only observed in wet spun fibres. The cause of this is not clear but the fact that it was absent in DJWS fibres (Plate 7.8) indicates that the cause may be associated with certain rheological effects on the fluid threadline close to the spinneret. Such effects were presumed absent in DJWS due to the air gap, resulting in an extremely thin, less tensioned and perhaps very slightly oriented outer skin. In wet spinning however, a much thicker and rigid skin is formed from the very beginning of filament formation. Because chitin fibres shrink enormously during drying, it is therefore likely that such contraction would have a more damaging effect on the surfaces of wet spun fibres. (The surface feature obtained is not unique to undrawn wet spun chitin fibres alone. Similar surface features were noticed recently by Akbari [182] for (very slightly drawn, DR \sim 1.2) wet spun 'Courtelle' type filament washed using either graded isopropanol or graded acetone.) However, unlike chitin, the production of such fibres was said to depend on the processing stage reached and the method of dehydration used. The cause was associated mainly with radial shrinkage particularly in the skin region.

Looking at the cross-sections under the microscope, the variations in the cross-sectional shapes earlier observed with the DMA/water bath (section 3.2.2.1) had almost disappeared. All the fibres appeared to have a mixture of circular and oval shapes. This may have been the result of spinning without wrapping, relaxing in hot

water and storing in methanol before drying. It appeared that highly irregular cross-sections were obtained when the highly tender fibres (produced in high DMA content baths) were washed under tension on the reels. It is possible that the fibre structure collapses very easily under such operations. Fibres obtained from the rest of the coagulants by contrast had (mostly) almost circular cross-sections.

Plates 7.9 and 7.10 show the X-ray diffraction patterns obtained from DMA/water and methanol baths respectively. It seems that the fibres were only slightly crystalline and very low in orientation. Fibres spun into methanol appear to be slightly more oriented than those spun into the 75% DMA bath.

7.3.3 Study of the drawing operation

In most spinning systems, the final mechanical properties of fibres particularly tensile strength and elasticity are usually improved by drawing, as most fibres spun undrawn are either amorphous or randomly crystalline and lack molecular orientation. Depending on the nature of the fibre, drawing may be carried out either at room temperature [183] or at elevated temperatures in a hot air chamber [184], or on contact with hot plates [185-187] or in liquid baths [113,188,189]. It can be performed as a separate operation as with the spinning of most synthetic polymers (eg. melt spun nylon and polyester fibres) or as an integral part of the spinning process (eg. acrylic, viscose and most other wet-spun fibres).

Attempts made to draw (as a separate operation) showed that it was not possible to carry out any effective drawing on chitin fibres because of their limited extensibility. Similarly, prospects for

drawing (as part of the spinning operation) were made difficult by the tensioning of the filaments which always occurred when the filaments were passed around the advancing reels in an attempt to wash them. However, further study of the spinning processes indicated that a reduction of the number of times the filaments were passed around the rollers, followed by a relaxation in a hot water bath and storage in a methanol bath somehow preserved the fibre extensibility. For this reason, it was decided to carry out a further attempt to draw the fibres, this time with only one turn per roller before and after drawing. When this proved to be successful, attempts were then made to examine the effect of other spinning variables on the extent of drawing and the properties of the fibres so produced. In this respect both wet and dry-jet wet-spinning techniques were employed, starting first of all with wet spinning. In each case, the fibres produced were drawn in air or through a hot water bath at 80-85°C. All the samples were stored as usual in methanol for 2 hours after drawing. At the end of this period, the methanol was drained off by suction and each sample was placed separately on a glass dish and dried overnight in a vacuum oven at room temperature.

The spinning conditions used for wet spinning are listed in Table 7.5, while those used for dry-jet wet-spinning are shown in Table 7.15.

7.3.3.1 Wet spinning

Initially, fibres were spun into different coagulation baths at room temperature (21-25°C) and drawn in air or in a hot water bath. Attempts were made (where necessary) to draw the fibres at various draw ratios, until the "maximum draw ratio" (defined as the ratio of

TABLE 7.5: Spinning conditions for wet spun fibres
(Samples 7-23 to 7-82)

Fixed conditions

Chitin: C2 hydrolysed for 2 hours starting with the NaOH treatment except where otherwise stated

First advancing reel speed: 23.3 m/min

Jet stretch ratio: 0.78

Hot draw bath (water): 80-85°C

Filaments were passed around each roller with one turn. They were drawn either in air or through the hot water draw bath, stored in a methanol bath for 2 hours and dried in a vacuum oven (full vacuum) at room temperature overnight.

Dope temperature: 25°C except where otherwise indicated

The rest of the fixed spinning conditions were as described in Table 7.1

Coagulation bath length: 120 cm

Variable conditions

Second advancing reel speed: 24.3 m/min-30.3 m/min

Coagulating bath temperature: methanol 21-22°C;
DMA/water, 75/25, v/v and water 5-75°C;
water (pH 3.4) and water (pH 10.6) 20-60°C

Chitin concentration: 5-9%(w/w) chitin

LiCl concentration: 5-10%(w/w) LiCl

Coagulants: methanol, butanol, DMA/water, water, water (pH 3.4)
and water (pH 10.6)

Spinneret hole size: 80-300 µm

the speed of the second advancing reels to that of the first advancing reels above which continuous spinning was not possible because of filament breakages) was reached. Table 7.6 shows the results obtained for the effect of drawing on fibre properties. It is clear that, generally, as the draw ratio was increased the values of the extensibility and tensile factor decreased while tenacity increased. The data also show that fibres drawn in air always have the higher count and extensibility, but lower values of tenacity when compared with those drawn in hot water under otherwise similar conditions. Excepting fibres spun into a methanol bath, it appears that drawing in air at a 4% draw ratio was not as effective as in a hot water bath. The reason for such ineffectiveness may be associated with the elastic behaviour of the still highly swollen filaments. Fibres spun into methanol, although originally very swollen, deswelled as a result of the high volatility of the methanol. Because drawing in hot water involved arrangements in which the fibres had not only to change direction abruptly, but also to pass between guides, extra tensions were imposed on them, and for those fibres that were very delicate, this meant extra stretching. The surface structures of the fibres spun into methanol and DMA/water 75/25 and drawn by 4% in hot water were observed to be different from similar fibres drawn in air. Such fibres drawn in hot water were smoother and more lustrous than those drawn in air.

However, while it was possible to vary the draw ratio between 4 and 20% when fibres were drawn in air, it could only be varied between 4 and 12% when drawing in hot water. In all the cases, the capacity to draw the fibres within these ranges in any of the drawing media depended more or less on the coagulant. It was not possible to

Table 7.6: Effect of drawing on wet spun fibres produced from various coagulants at room temperature (21-25°C)

Sample No.	Coagulant	Draw ratio (%)	Fibre diameter (µm)	Fibre Count (dtex)	Tenacity T (g/dtex)	Extensibility E (%)	Tensile Factor TE ^{1/2}
7-23	DMA/water	4	24.7	6.6	1.48	18.0	6.28
7-24	75/25, v/v	4	(34.5)	(13.0)	(0.96)	(50.5)	(6.79)
7-25	(25°C)	10	23.4	6.0	1.60	11.1	5.33
7-26	methanol	4	25.0	6.8	1.51	21.8	7.05
7-27	(21°C)	12	23.0	5.9	1.91	11.8	6.56
7-28		4	(25.5)	(7.1)	(1.43)	(31.2)	(8.00)
7-29		15	(24.0)	(6.3)	(1.80)	(12.6)	(6.40)
7-30		20	(23.0)	(5.9)	(1.93)	(9.4)	(5.9)
7-31	butanol	4	(30.0)	(9.8)	(0.93)	(55.0)	(6.90)
7-32	(23°C)	15	(26.5)	(7.8)	(1.43)	(29.4)	(7.75)
7-33		20	(24.0)	(6.3)	(1.45)	(15.6)	(5.73)
7-34	water	4	27.0	8.0	1.24	31.3	6.94
7-35	(25°C)	4	(30.5)	(10.2)	(1.01)	(44.4)	(6.73)
7-36	water (pH 3.4)	4	27.0	8.0	1.26	29.5	6.84
	(25°C)						
7-37	water (pH 10.6)	4	27.0	8.0	1.20	32.4	6.83
	(25°C)						

() drawn in air

Spinning conditions: dope concentration: 7% (w/w) chitin, 8% (w/w) LiCl
 spinneret: 80 µm, 20 holes
 Dope temperature: 25°C

spin continuously (ie. without filament breakages within 1-2 minutes) with a draw ratio of 12% when the fibres were drawn in the hot water bath except when a methanol coagulating bath was used. It was not even possible to draw in hot water at any draw ratio examined when butanol was used as coagulant. (The introduction of butanol as one of the coagulants was prompted by the work reported by Nakajima et al [96] in 1984, part way through this work.) The filaments broke very easily between the guides in the draw bath. However, they could be drawn up to 20% in air as with methanol. For draw ratios above 10% in a hot water bath, it was observed that fibre breakages were reduced when

- (i) the guides were slightly tilted (in the direction of the fibre movement) instead of in the usual vertical positions; (see Fig. (7.2)
- (ii) guides with wide angles were used. This reduced filamentation and subsequent fibre accumulation behind the guides;
- (iii) the depth of immersion of the second guide was slightly lower (about 25 mm) than the first guide. This was presumed to reduce the angle of contact between the first guide in the bath and the filaments, thereby reducing the frictional drag at the guides;
- (iv) fibre withdrawal from the bath by the draw rollers was not too steep.

Table 7.7 shows the maximum draw ratios (expressed in percentages) attainable using an 80 μm 20 hole spinneret for some of the coagulants used. It can be seen from the table that the maximum draw ratios attainable for all the coagulants were very small when compared with other spun fibres such as acrylic (600-1200%; solvent, DMA or DMF; spinning bath, DMA/water or DMF/water) [113,190,191]; cellulose

FIG. 7.2: Tilting guides to reduce frictional drag on the filament during drawing

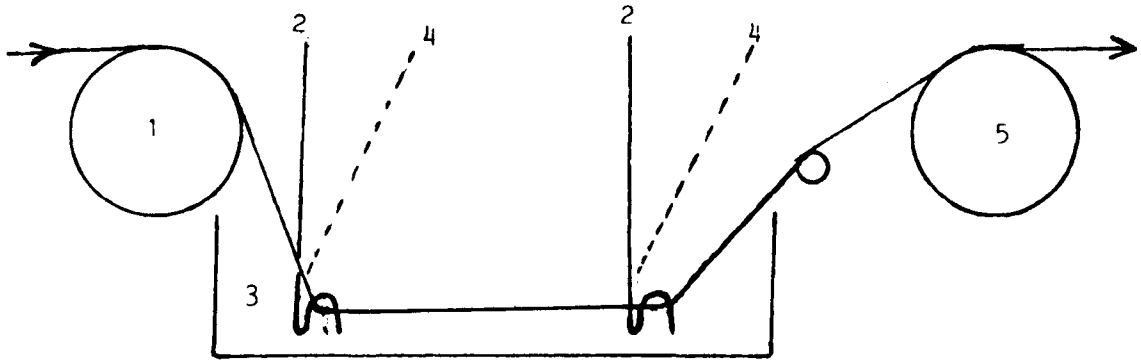

1. 2nd reel of the first pair of advancing reels
2. Fibre guides (in vertical position)
3. Hot water draw bath ($80-85^{\circ}\text{C}$)
4. Fibre guides (slightly tilted in the direction of the fibre movement)
5. 1st reel of the second pair of advancing reels

TABLE 7.7: Maximum draw ratio for some of the coagulants at 21-25°C (spinneret 80 μm, 20 holes)

Coagulant	Maximum draw ratio (%)	
	in hot water (80-85°C)	in air
DMA/water, 75/25, v/v	12	15
Methanol	12	22
Butanol	3	21
Water	10	15

~~acetate~~ acetate (190-250%; solvent, acetic acid; spinning bath, water/ acetic acid)[192]; and normal viscose rayon (20-200% or more depending on the particular process involved)[193,194]. However, they are only slightly less than the value of 30% quoted for alginate fibres by Tallis [195]. Recently, a greater draw ratio in steam (65-70°C) of between 130 and 170% has been claimed for alginate fibres [132,196].

Now that it had become obvious that fibre tenacity increases as expected with increase in draw ratio, other spinning variables which were considered likely to increase the capacity for drawing the fibres were examined. Such variables included:

- (i) reduction in jet stretch ratio
- (ii) increase in spinneret hole size
- (iii) change in coagulation bath temperature
- (iv) change in chitin and LiCl concentration.

Variable (i): reduction in jet stretch ratio

This was considered using DMA/water. Fibres were spun at a jet stretch ratio 0.4 (a slight relaxation could be observed in the coagulation bath) and drawn by 10% in the hot water bath. The fibre properties obtained showed an extensibility of 15.3% and a tenacity of 1.45 g/dtex. Although the extensibility was higher than the higher jet stretch equivalent sample (Table 7.6, sample 7-25) by a factor of about 1.4, the tenacity decreased by a factor of only about 1.1. Although fibres were spun without breakages, it was not considered advantageous to operate at such a low jet stretch ratio in view of the low tenacity obtained. Attempts to increase the draw ratio above 10% with this jet stretch ratio of 0.4 resulted in filament breakages within 2-3 minutes.

Variable (ii): increase in spinneret hole size

Table 7.8 shows the fibre properties obtained using the 150 μm , 10 hole spinneret and the 300 μm , 10 hole spinneret. The table also contains the data for the 80 μm , 20 hole spinneret (taken from Table 7.6), included for comparison. The results obtained show that spinning could be conveniently carried out using a 12% draw ratio for both spinnerets and as much as 20% for the 150 μm , 10 hole spinneret. It was not possible to draw the fibres spun with the 300 μm spinneret above the draw ratio of 12%. This appeared to be because the fibres were much more swollen using this spinneret and they broke very easily. In comparison with the maximum draw ratio of about 12% previously obtained (using DMA/water, 50/50, v/v; Chapter 3, Tables 3.2 and 3.7) with the 150 μm spinneret, when the fibres were drawn after they were extensively tensioned on the reels, a draw ratio of 20% was quite an improvement. Observation of the fibre properties, however, showed that they have only slightly improved (by a factor of 1.06-1.17) over the previous values, in spite of the higher draw ratio employed. These results further confirm the effect of wrapping the filaments around the advancing reels as an effective drawing operation (see section 7.3.1). It can be seen that while the fibre tenacity increases with decreasing spinneret hole size, the extensibility decreases. Since the increase in tenacity was thought to be significant, it was decided to continue with the 80 μm spinneret.

Variable (iii): change in coagulation bath temperature

In an earlier review of the effect of coagulation bath temperature on wet spun fibres, it was indicated that a rather general conclusion

TABLE 7.8: Effect of spinneret hole diameter on fibre properties
(Coagulant: 75% DMA)

Sample No.	Spinneret hole size (μm)	Draw ratio (%)	Fibre diameter (μm)	Fibre count (dtex)	Tenacity T (g/dtex)	Extensibility E (%)	Tensile factor $TE^{\frac{1}{2}}$
7-25	80	10	23.4	6.0	1.60	11.1	5.33
7-38	150	12	51.8	22.0	1.43	19.0	6.23
7-39	150	20	44.3	18.0	1.50	10.0	4.74
7-40	300	12(max)	96.8	90.0	1.41	23.1	6.78

Spinning conditions: Drawing medium: hot water ($80-85^{\circ}\text{C}$)
Dope concentration: 7% (w/w) chitin, 8% (w/w) LiCl
Dope temperature: 25°C
Coagulation bath temperature: 25°C
Linear rate of extrusion (a) $150\ \mu\text{m}$ 10 hole spinneret: 17 m/min
(b) $300\ \mu\text{m}$ 10 hole spinneret: 4.2 m/min
The rest of the conditions used are as listed in Table 7.5

is that decrease in bath temperature leads to improved fibre properties. Therefore, the effect of coagulation bath temperature on the fibre properties was investigated using as coagulants DMA/water, 75/25 and water. Although it was possible to increase the temperature of the methanol bath to about 30°C, it was thought to be ill-advised, so methanol was excluded from the experiments. For DMA/water baths, the temperatures were varied between 5 and 75°C at 10°C intervals, but at slightly non-consistent intervals of 15-20°C for the water bath. While the fibres spun from the DMA/water bath were drawn by 12%, those spun from water were only drawn by 4%. (The difference in the draw ratios used was due to too much fibre breakage encountered when the spin bath was at 5°C on attempting to draw the fibres by 12%. However, when the draw ratio was reduced to 4% and spinning was found satisfactory, it was not thought necessary to change it.) As for the DMA/water bath, it was not possible to spin at 5°C as the threadlines were weak and could not be taken-up without breakage; at such a temperature the DMA/water mixture was very obviously more viscous than at 25°C. Around 20°C, the fibres could be drawn at 12% draw ratio, though with much difficulty as the fibres still broke often. Above 35°C, spinning was very steady at 12% draw ratio and no fibre breakage was observed.

Table 7.9 shows the effect of coagulation bath temperature on fibre properties produced using DMA/water, 75/25 and water as coagulants. Figures 7.3-7.5 show the effects of coagulation bath temperature on the tenacity, extensibility and tensile factor of the fibres for both baths, while Fig. 7.6 shows the effect of bath temperature on fibre diameter for the water bath. For the DMA/water bath, a continuous improvement in the values of extensibility and tensile factor with increasing bath

TABLE 7.9: Effect of coagulation bath temperature on fibre properties

Sample No.	Coagulant	Bath temperature (°C)	Fibre diameter (µm)	Fibre count (dtex)	Tenacity T (g/dtex)	Extensibility E (%)	Tensile factor TE ^{1/2}
7-41	DMA/water 75/25,v/v	5	weak threadline; could not wind				
7-42		25	24.6	6.8	1.58	10.6	5.14
7-43		35	26.8	7.5	1.64	14.1	6.16
7-44		45	"	"	1.59	15.1	6.18
7-45		55	"	"	1.60	17.0	6.60
7-46		65	"	"	1.61	19.5	7.11
7-47		75 ^a	"	"	1.63	20.0	7.29
7-48		75 ^a	38.0	15.0	0.80	78.0	7.07
7-50	Water	5	24.0	6.5	1.42	26.4	7.30
7-51		20	27.5	8.4	1.20	32.8	6.87
7-52		40	28.5	8.8	1.17	42.0	7.58
7-53		60	30.0	9.8	0.95	53.3	6.94
7-54		75	34.6	12.5	0.86	67.0	7.04
7-55		75 ^b	31.7	10.8	1.28	51.3	9.17

a undrawn and relaxed in hot water bath

b draw ratio: 12%

Spinning conditions: Dope concentration: 7% (w/w) chitin, 8% (w/w) LiCl

Draw ratio; DMA/water: 12%

water: 4%

Draw medium: hot water at 80-85°C

Spinneret: 80 µm 20 hole

Other conditions are as listed in Table 7.5

FIG. 7.3: Effect of coagulation bath temperature on tenacity

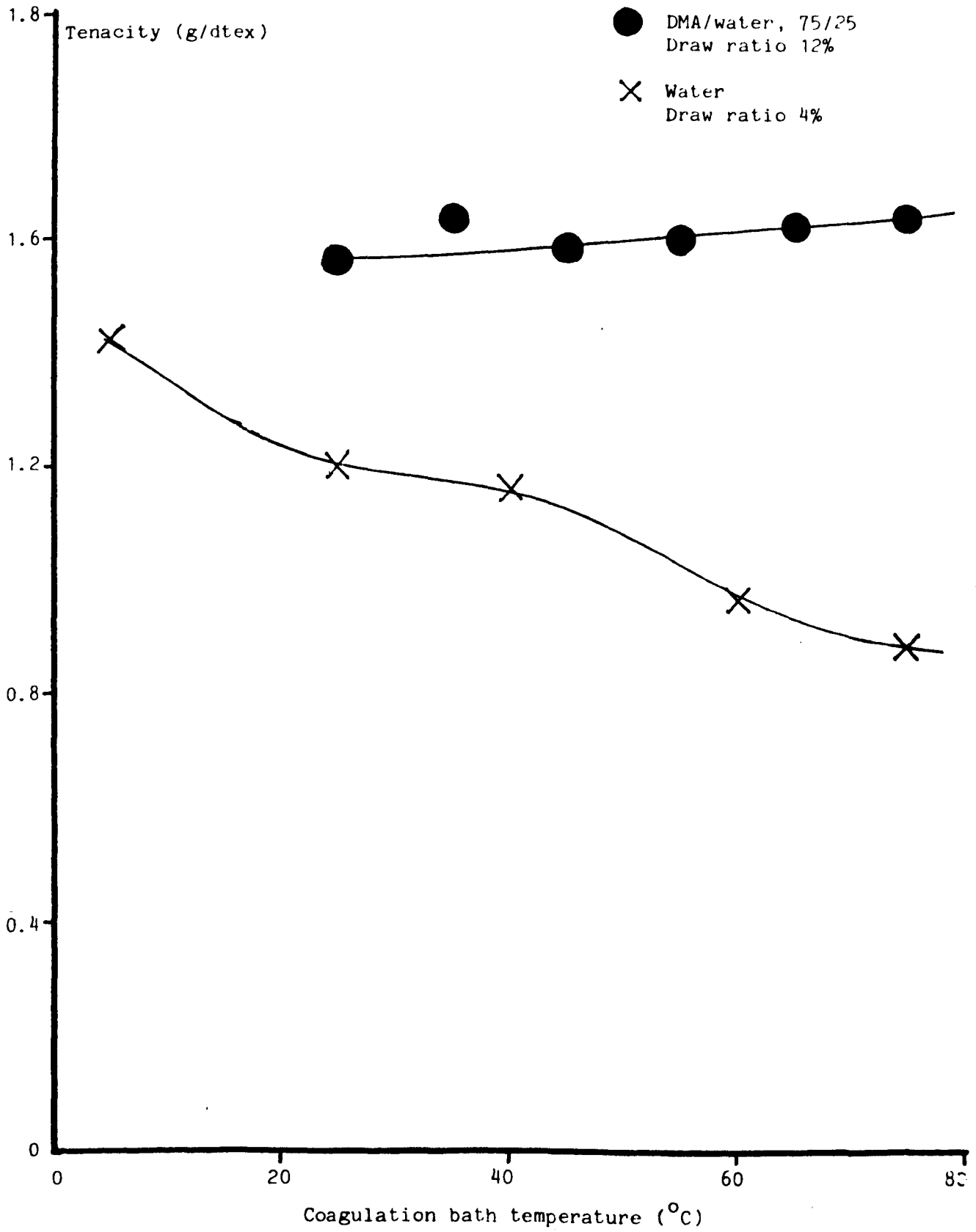

FIG. 7.4: Effect of coagulation bath temperature on extensibility

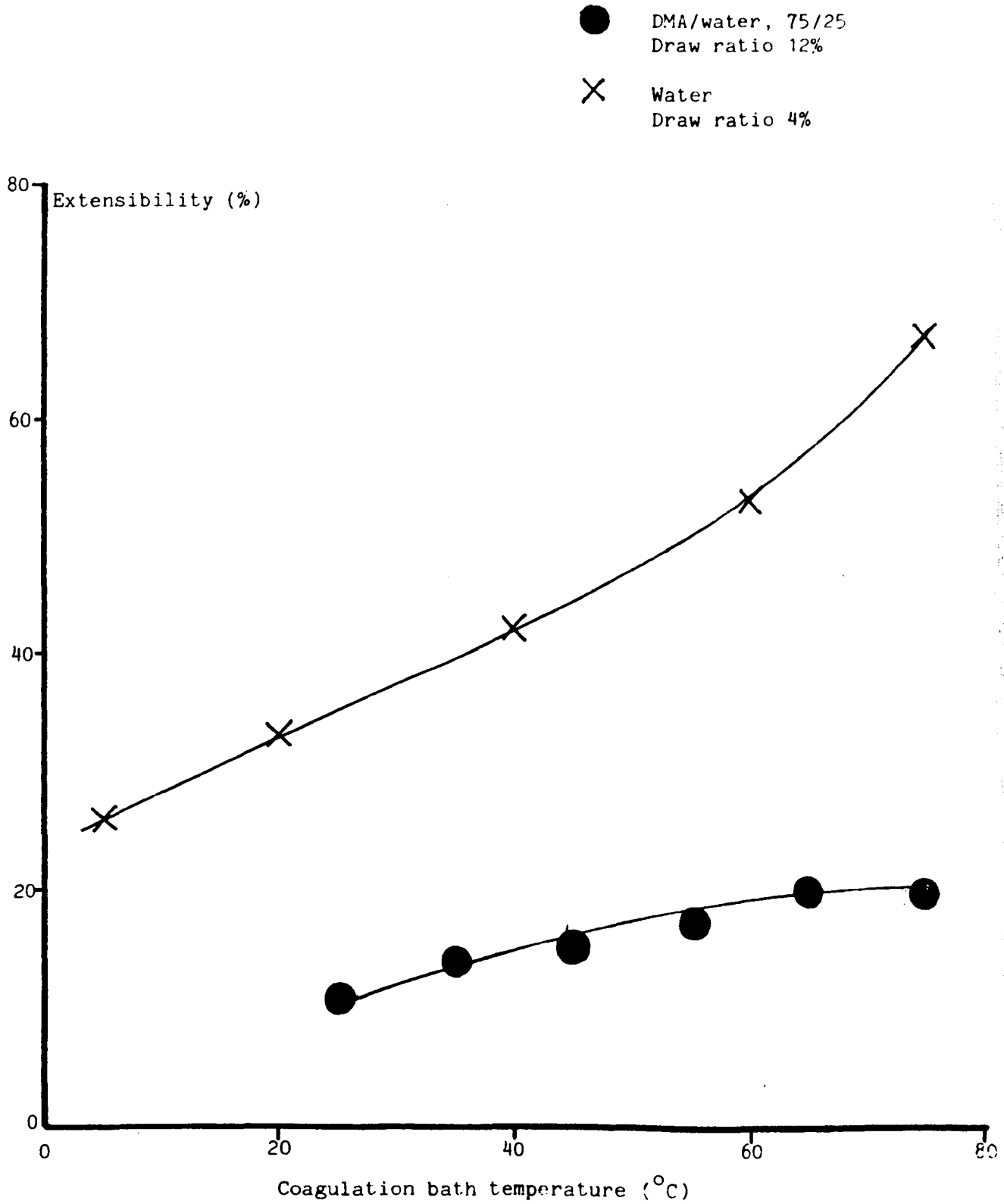

FIG. 7.5: Effect of coagulation bath temperature on tensile factor

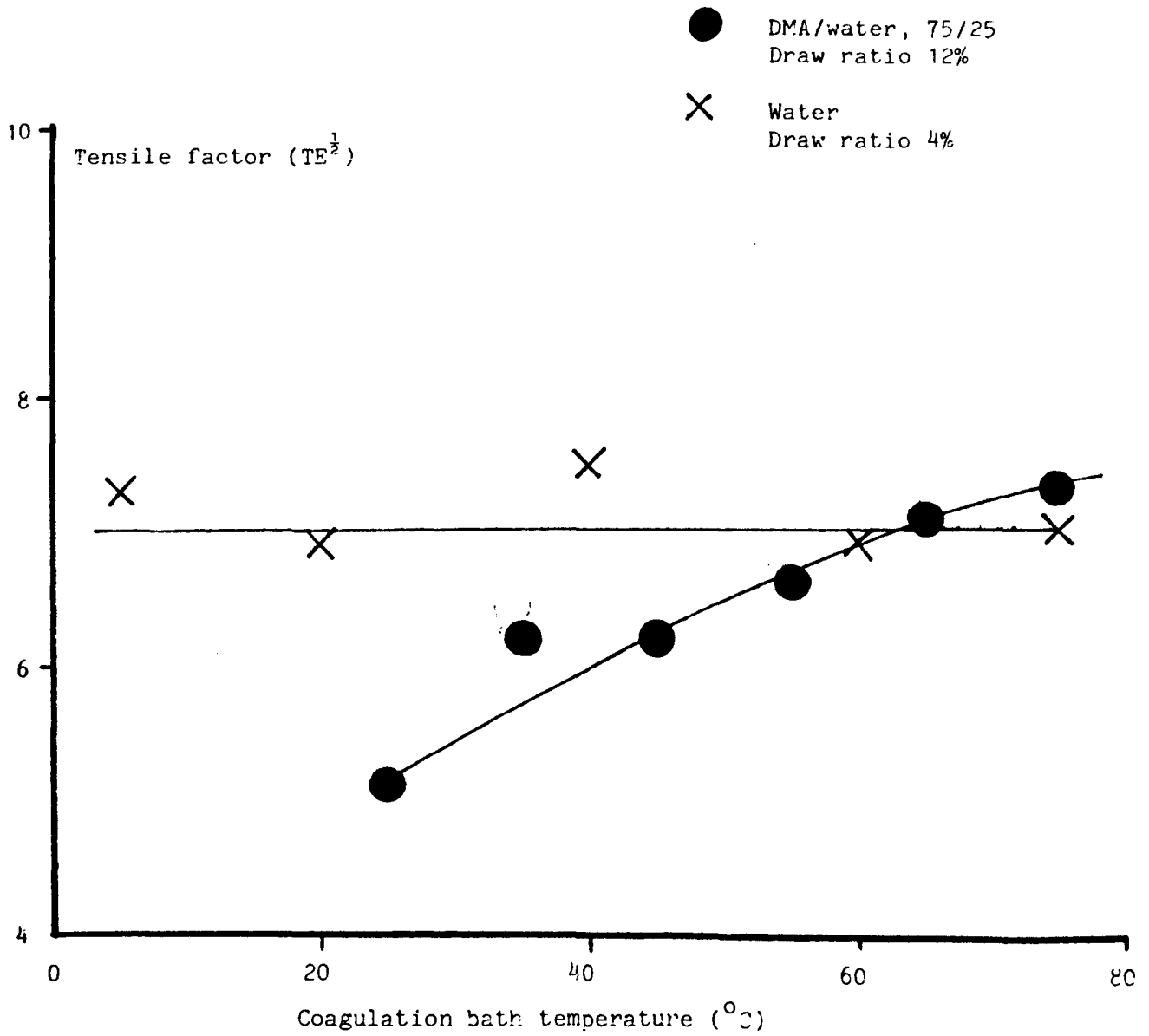
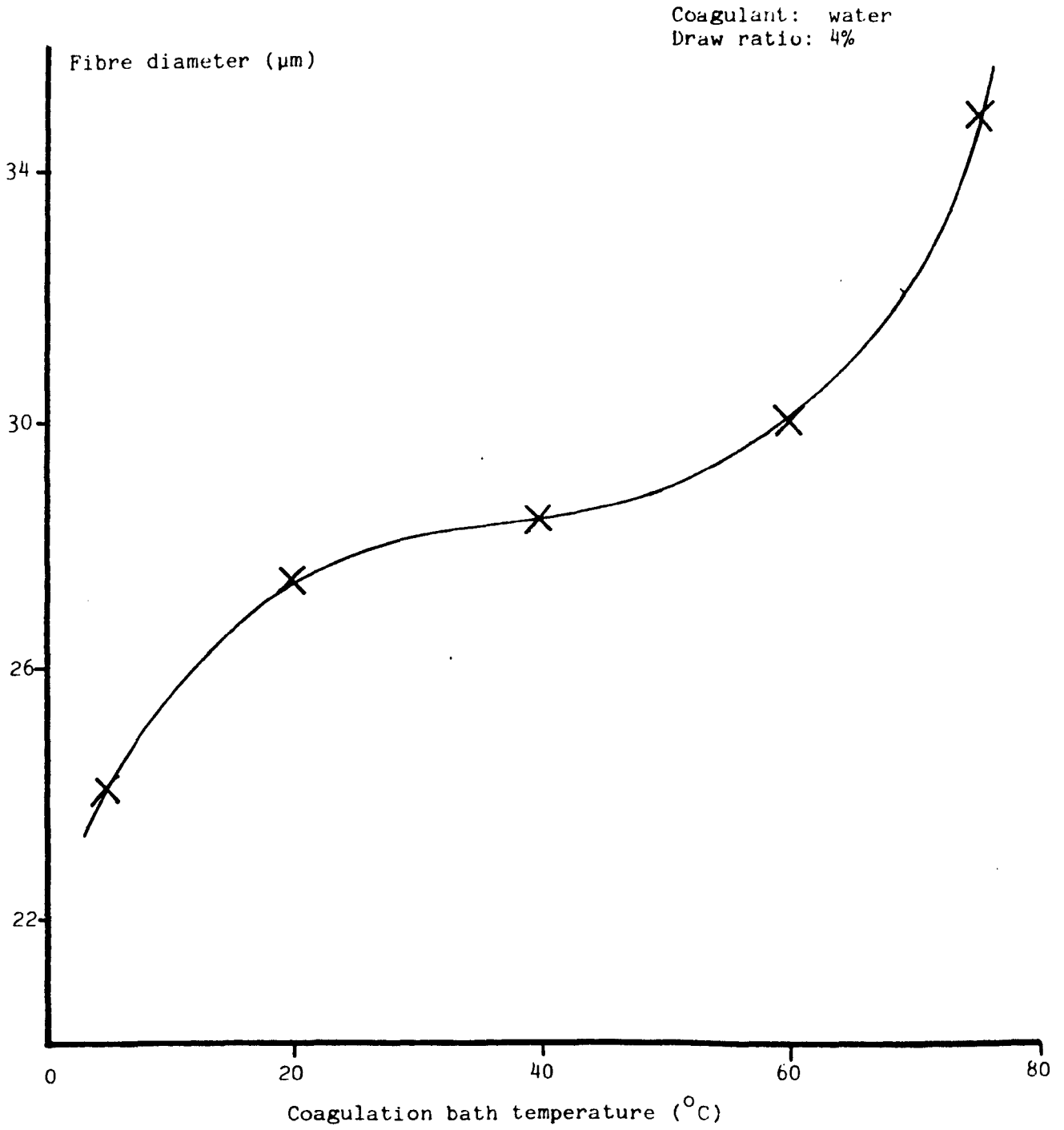

FIG. 7.6: Effect of coagulation bath temperature on fibre diameter



temperature was observed. The effect of increased bath temperature on tenacity is almost undetectable. However, it led to a progressive improvement in fibre toughness as is self-evident from the values of the tensile factor. This observation ties in well with the observed effects of bath temperature on undrawn fibres. When spun into the bath at 75°C, the fibre (undrawn and relaxed in hot water) had an extensibility of 78% and a tenacity of 0.80 g/dtex. Fibres produced from the coagulation bath at 25°C under otherwise similar conditions, had an extensibility of 64% and a tenacity of 0.78 g/dtex (see Table 7.3). However, at coagulation bath temperatures above 25°C, fibres produced (drawn or undrawn) always had higher diameters.

The tenacity values for fibres spun into the water bath were observed to decrease with increasing bath temperature (presumably due to increase in fibre diameter or dtex with increasing bath temperature) in contrast with those spun into the DMA/water bath; while the tensile factor remained almost unchanged. Otherwise the effects of bath temperature are similar for both baths. The effect on fibre diameters appears to be more pronounced with the water bath (Fig. 7.6). At a bath temperature of 75°C, the values of fibre diameter and extensibility were about a factor of 1.45 and 2.54 respectively more than the values at 5°C. And even when the fibres were drawn by 12%, they were still observed to possess a high extensibility, 51% and a diameter, about 32 μm (compared with a theoretical value of 21 μm obtained using equation 2.27; fibre density (ρ_F) 1.39/cm³, dope density (ρ_D) 1.086 g/cm³; spinneret 80 μm , 20 holes and take-up speed 23.3 m/min). These changes observed with increasing bath temperatures are most likely related to an increased skin toughness earlier mentioned (section 7.3.1).

The effect of increasing the bath temperature led presumably to even more rapid skin formation on the surface of the fibre (see chapter 6).

Of the variables examined so far, coagulation bath temperature clearly was found to be the most important variable in its effects on the fibre properties. It offered the best opportunity for increasing the tenacities of fibres spun into DMA/water or water baths since fibres could be produced at higher draw ratios in air or in a hot water bath.

The results of the effect of draw ratio obtained using DMA/water and water baths at 75°C are shown in Table 7.10. In both cases the fibres could be drawn without breakages by 20% in a hot water bath and 30% in air. Fibres spun into a DMA/water bath were especially remarkable as they spun on every occasion continuously for over 5 minutes before they were intentionally broken. As usual an increase in draw ratio increased the fibre tenacity and decreased the extensibility. The decrease in extensibility was, however, more gradual than was observed in the fibres spun into these baths at room temperature. The values of the tensile factor appeared rather inconsistent and increased or decreased depending on whether drawing was in air or in a hot water bath, but generally the value fluctuated between 7 and 9. Figures 7.7 and 7.8 show the tenacity and extensibility for some selected samples spun into methanol, butanol (data from Table 7.6), DMA/water, 75/25 and water (data from Table 7.10) and drawn either in air or in a hot water bath as a function of draw ratio. While the methanol and butanol baths were at 21-23°C, the DMA/water and water baths were at 75°C. Generally, high tenacity fibres can be spun using either DMA/water, 75/25 at 75°C

TABLE 7.10: Effect of drawing on fibres spun into various coagulation baths at 75°C

Sample No.	Coagulant	Draw ratio (%)	Fibre diameter (μm)	Fibre count (dtex)	Tenacity T (g/dtex)	Extensibility E (%)	Tensile factor TE ^{1/2}
7-56	DMA/water	4	30.0	9.5	1.33	40.5	8.46
7-47	75/25, v/v	12	26.8	7.8	1.63	20.0	7.29
7-57		20	24.0	6.5	2.14	13.5	7.86
7-58		4	(32.0)	(10.8)	(0.85)	(66.0)	(6.90)
7-59		20	(27.5)	(8.8)	(1.51)	(25.0)	(7.55)
7-60		30	(25.0)	(7.0)	(2.0)	(17.3)	(8.32)
7-54	Water	4	34.6	12.5	0.86	67.0	7.04
7-55		12	31.7	10.8	1.28	51.3	9.17
7-61		20	29.0	9.7	1.37	34.0	7.79
7-62		20	(30.6)	(10.0)	(1.30)	(37.2)	(7.93)
7-63		30	(28.0)	(8.5)	(1.64)	(28.9)	(8.82)
7-64	Water(pH 3.4)	20	(30.6)	(10.0)	(1.35)	(37.2)	(8.23)
7-65	Water (pH 10.6)	20	(30.6)	(9.5)	(1.40)	(33.8)	(8.31)

() drawn in air

Spinning conditions are as listed in Tables 7.5 and 7.9

FIG. 7.7: Effect of drawing on tenacity

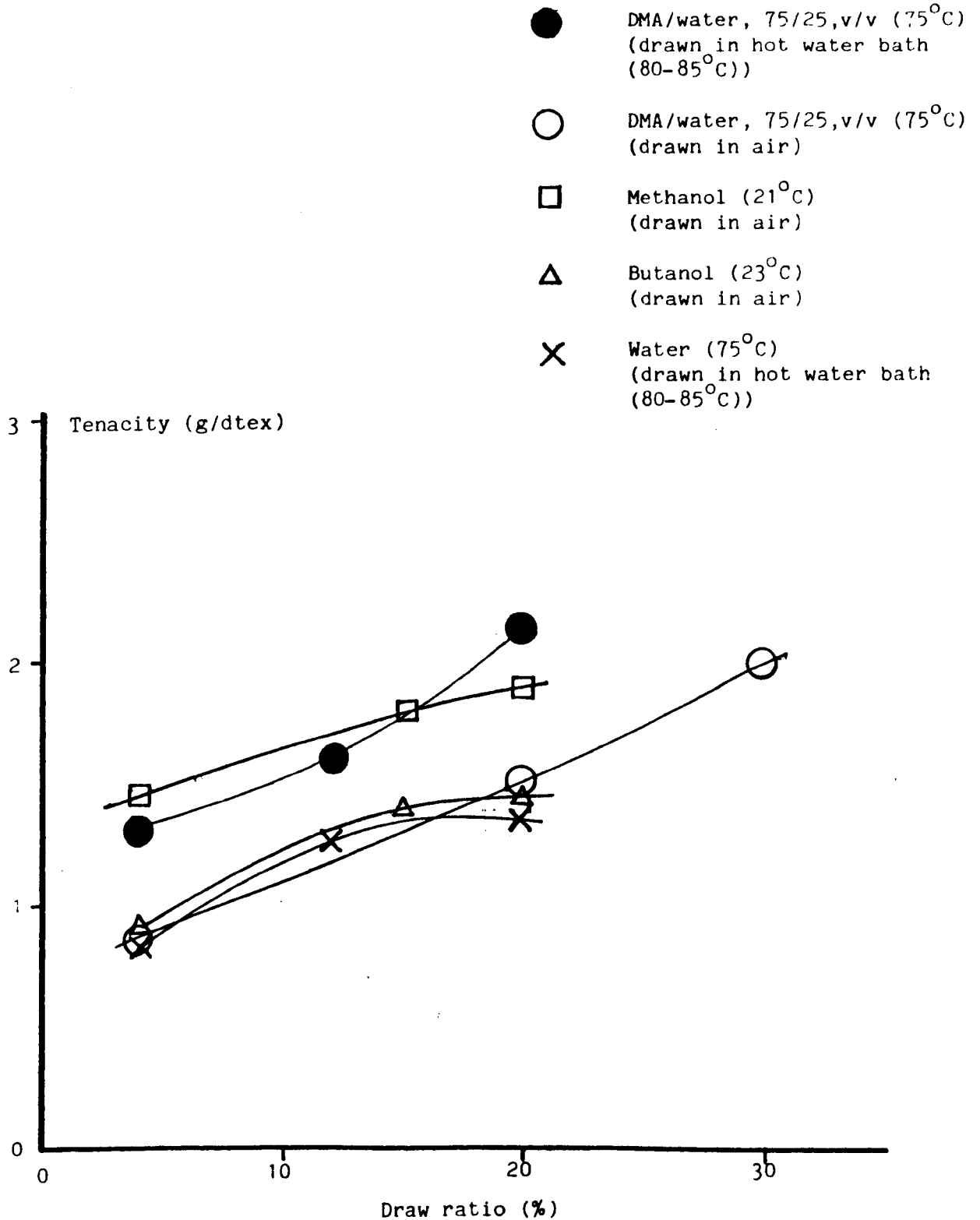
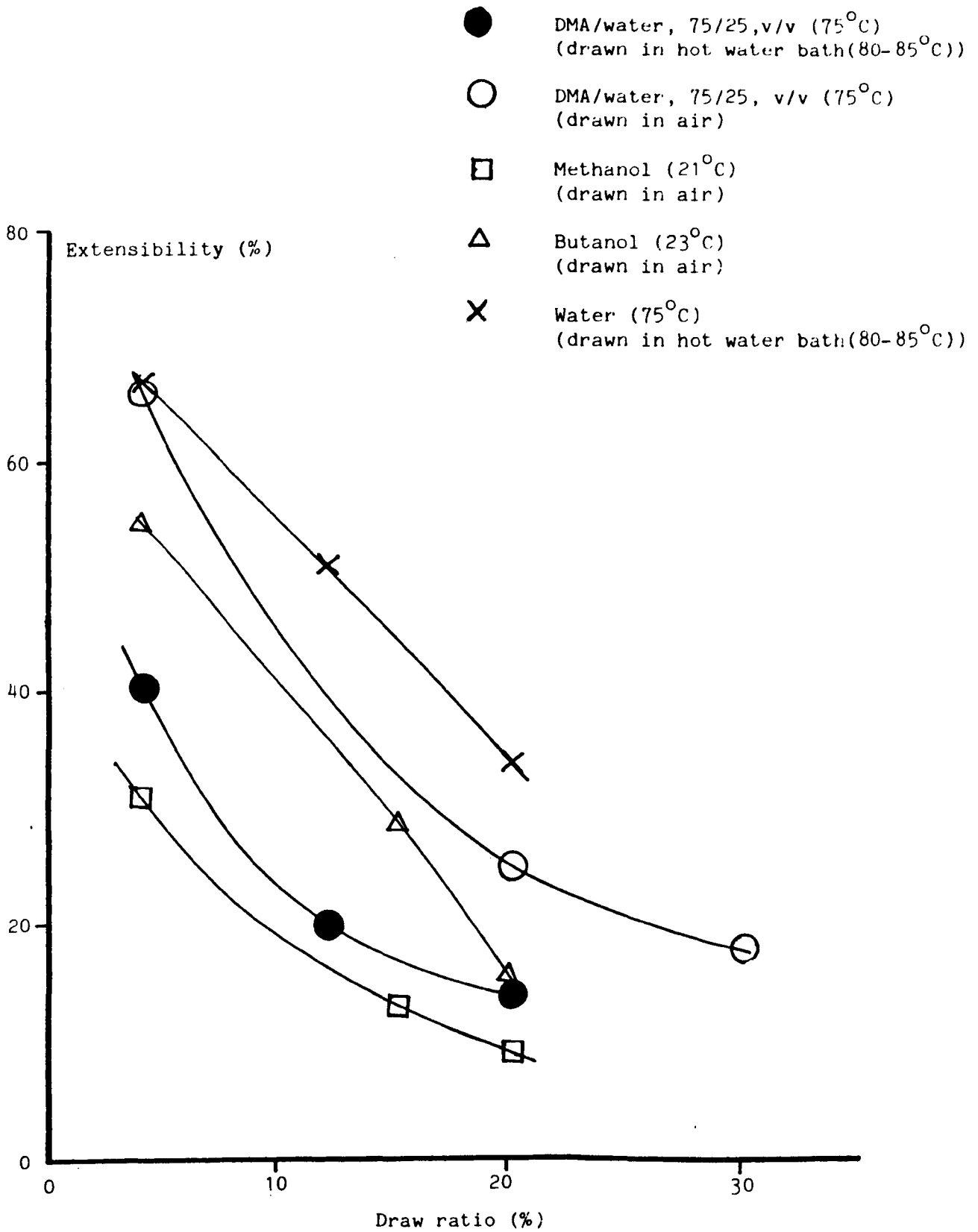

FIG. 7.8: Effect of drawing on extensibility



or methanol at room temperature. To obtain tenacities up to 2 g/dtex, such fibres spun into DMA/water bath may be drawn in air by 30% or in a hot water bath by 20%; and when a methanol bath is used, they may be drawn in air by 20% or in a hot water bath by 12%. It is also possible to use a DMA/water bath at lower temperatures (between 40 and 75°C). While it was not possible to obtain tenacity values up to 2 g/dtex from water and butanol baths, fibres produced from these baths were generally high in extensibilities.

Variable (iv): Change in chitin and LiCl concentration

In section 3.2.2.4, a preliminary study of the effect of dope concentration using water (pH 3.4) as coagulant was made, and it was found that the fibre mechanical properties changed only slightly with increasing dope concentration, although an optimum concentration appeared around 7% chitin. It was also pointed out that the range over which changes in dope concentration could be made was very narrow (5-9%). The reasons for the limitation was given in section 5.4.2. Although this limitation still existed it was thought appropriate to confirm some of these earlier results, and if possible improve on them, now that a better spinning procedure had been established.

Although no formal studies of the effect of LiCl on fibre properties have been made, it was shown in section 5.4.1 that it too, like dope concentration, could only be used within a narrow concentration range of about 5-10%. It was decided also to study the effects of LiCl concentration on the fibre properties.

The spinning conditions used were essentially the same as those listed in Tables 7.5 and 7.9.

Table 7.11 shows the effect of the polymer concentration on the mechanical properties of the fibres. The fibres were spun using DMA/water, 75/25 (at 25°C or 75°C) and methanol (21°C) as coagulants. With the LiCl concentration fixed at 8%, the chitin concentrations were varied between 5 and 9%. Below 5% chitin (C2-2), it was not possible to carry out spinning because of the low dope viscosity. With the 5% dope, continuous spinning into a DMA/water bath at or above 30°C was not possible as the fibres became weak and broke frequently in the coagulation bath; presumably due to the decrease in viscosity with increasing bath temperature. In fact, at a bath temperature of 75°C, the 5% dope was observed to spread on the face of the spinneret and at no time did it form continuous threadlines. However, when the DMA/water bath was at room temperature, fibres could be spun using a draw ratio of 4%. Above this draw ratio, frequent breakage occurred. At this dope concentration, it was found that spinning into a methanol bath was far better and fibre properties obtained were also better. Above 9% dope concentration, the dopes became too viscous and apart from the tendency to gel much more rapidly, it was almost impossible to obtain fully degassed dopes. Heating such dopes up in an attempt to reduce their viscosities and facilitate degassing only led to more rapid gelation. With the 9% dope, there was no problem of spinnability. The fibres produced, unlike those from a 7% dope, could be drawn in a DMA/water bath at room temperature by 12% with no observed fibre breakage.

As can be seen from Table 7.11, both the tenacity and tensile factor values appear to become maximum around 7% chitin confirming the earlier results. On the other hand, the extensibility values appear

TABLE 7.11: Effect of dope concentration on fibre properties

Sample No.	Coagulant	Dope conc. (%)	Coag. bath temp. (°C)	Draw ratio (%)	Fibre diam. (µm)	Fibre count (dtex)	Tenacity T (g/dtex)	Extensibility E (%)	Tensile factor $TE^{\frac{1}{2}}$
7-66	DMA/water 75/25	5	25	4	22.5	5.0	1.12	15.8	4.46
7-23		7	"	"	24.7	6.6	1.48	18.0	6.28
7-67		9	"	"	28.0	8.7	1.24	19.0	5.40
7-68		5	25	12	Not possible to spin; frequent breakages				
7-69		7	"	"	Could spin; though fibre breakages still occurred				
7-70		9	"	"	27.0	7.9	1.38	11.30	4.60
7-71		5	75	12	Not possible to spin; dope spread on the surface of the spinneret				
7-43		7	"	"	26.8	7.5	1.63	20.0	7.29
7-72		9	"	"	28.8	9.0	1.45	22.10	6.80
7-73	Methanol	5	21	4	22.0	5.0	1.37	20.5	6.20
7-26		7	"	"	25.0	6.8	1.51	21.8	7.05
7-74		9	"	"	27.5	8.0	1.33	22.0	6.24
7-75		"	"	12	26.7	7.2	1.50	10.5	4.86
7-76		9	"	"	20	(23.4)	(6.0)	(1.51)	(10.6)

() drawn in air

Spinning conditions: LiCl concentration: 8% (w/w)
Other conditions are as listed in Tables 7.5 and 7.9

to increase with dope concentration, although the increase is quite small, especially between the 7 and 9% values. These results are more clearly indicated for both coagulants at 4% draw ratio. The improved fibre properties obtained by spinning into DMA/water at 75°C becomes very obvious, when the results for the fibres spun from the 9% dope and drawn by 12%, are compared with similar results obtained with the bath at 25°C. With DMA/water at 75°C, the value of the extensibility was twice that obtained with the bath at 25°C. When the methanol bath was used and fibres were drawn by as much as 20% in air, the tenacity only increased very slightly and the extensibility was low when compared with the value obtained for DMA/water (75°C).

Table 7.12 shows the effect of LiCl concentration on fibre properties produced using the same coagulants, under similar conditions as for the effect of dope concentration already described. The dope concentration was fixed at 7%, and the LiCl concentrations varied between 5 and 10%. At room temperature, below 5% LiCl, dissolution of 7% chitin was not complete, while at or above 10% LiCl, the complete LiCl solubility was not observed (see section 5.4.1). It was not possible to spin the 7% chitin-DMA/^{10%}LiCl dope, as it was found impossible to filter the solution, due to blockage of the filter, presumably caused by undissolved LiCl. However, it was possible to spin 6% chitin dissolved in DMA/10% LiCl after the dope had been kept at 60°C for 2 hours and then allowed to cool down 1 hour before spinning.

The results obtained show that changes in LiCl concentrations were found to be relatively inactive for varying either the extensibility or the tenacity of the fibres. However, although the tenacity values obtained from the dopes containing 5 and 8% LiCl were greater than for

TABLE 7.12: Effect of LiCl concentration on fibre properties

Sample No.	Coagulant	LiCl conc. (%)	Coag. bath temp. (°C)	Draw ratio (%)	Fibre diam. (µm)	Fibre count (dtex)	Tenacity T (g/dtex)	Extensibility E (%)	Tensile factor $TE^{\frac{1}{2}}$
7-77	DMA/water 75/25	5	25	4	24.0	6.2	1.42	13.0	5.12
7-23		8	"	"	24.7	6.6	1.48	18.0	6.28
7-78		10*	"	"	23.0	5.8	1.36	18.5	5.85
7-79	Methanol	5	75	12	26.5	7.2	1.68	19.2	7.36
7-47		8	"	"	26.8	7.5	1.63	20.0	7.29
7-80		5	23	4	26.0	7.2	1.47	25.0	7.35
7-26		8	21	"	25.0	6.8	1.51	21.8	7.05
7-81		10*	"	"	23.0	5.5	1.43	23.5	6.93
7-82		5	"	20	(24.6)	(6.2)	(1.84)	(10.6)	(6.00)
7-30		8	"	20	(23.0)	(5.9)	(1.93)	(9.4)	(5.9)

() drawn in air

* chitin concentration 6%, dope temperature ~40%

Chitin concentration 7% (w/w)

the 10% LiCl dope, the difference was probably not significant.

At this stage, the following summary was made:

- (i) Unlike acrylic fibres, winding of chitin fibres around the advancing reels as soon as they emerge from the coagulation bath resulted in a tremendous reduction in extensibility and a slight increase in tenacity. Similar effects were obtained from winding wet fibres on a bobbin. Although this behaviour was observed with all the coagulants examined, it appeared that the effect was more pronounced on fibres spun into a 75% DMA bath.
- (ii) Fibres spun without winding but relaxed in their respective coagulants had extensibilities 52-71% and tenacities 0.43-0.78 g/dtex, while similar fibres relaxed in a hot water bath and further stored in a methanol bath for 2 hours had extensibilities 51-65% and tenacities 0.78-0.92 g/dtex. This was an improvement as it provided a method for producing highly extensible chitin fibres with reasonable strength and toughness. As a result of these experiments it became clear that washing generally led to increase in fibre tenacity and only to a slight reduction in extensibility and that washing the fibres relaxed in succession in a hot water bath and methanol bath produced fibres with superior qualities.
- (iii) The time of treating chitin in PTS/IP did not appear to have any effect on the fibre properties. (see also conclusions for chapters 3 and 4)
- (iv) In order to draw chitin fibres, it was found necessary to reduce the number of times the filaments were passed around the advancing reels. One turn per roller was found satisfactory.
- (v) Fibres spun using various coagulation baths were drawn either

in air or in a hot water bath. Drawing in air was found less effective independent of the coagulants used, except at draw ratios above 15% due perhaps to the elastic nature of the partially coagulated filaments. However, the spinning process was more continuous when the fibres were drawn in air than in a hot water bath.

(vi) When the coagulation baths were at room temperature, it was only possible to draw the fibre in air by a maximum draw ratio of about 20%, and in a hot water bath by 12%. However, the capacity to draw the fibres up to these draw ratios depended on the coagulant used. Under these conditions, methanol was found to be the best coagulant.

(vii) Increase in coagulation bath temperature (for coagulants such as 75% DMA/water and 100% water baths) led to reduced fibre breakage and increased draw ratios to 30% for fibres drawn in air and 20% for those drawn in a hot water bath. Under these conditions, the 75% DMA bath was found to be the best coagulant.

(viii) Although the effect of increasing chitin concentration was not very significant, an optimum concentration was obtained at around 7% chitin. At 5% the dope viscosities were too low to sustain a continuous spinning process and at 9%, the viscosities became too high, limiting the range of spinnable concentrations to between 5 and 9% chitin.

(ix) Increase in LiCl concentration had little or no effect on the fibre properties.

(x) Only fibres spun into a 75% DMA bath and a methanol bath were observed to possess lustre after drawing.

The summary of the fibre properties (undrawn and drawn) and best spinning conditions are shown in Tables 7.13 and 7.14 respectively.

TABLE 7.14: Summary of the best spinning conditions

(a) For production of high tenacity fibres (>1.6 g/dtex)

Variable	Range		Best conditions	
Solid content (% w/w)	6-8		7	
Chitin treatment time (h)	2-6		2	
LiCl concentration (% w/w)	5-8		7	
Dope temperature (°C)	25-60		25	
Jet stretch ratio	0.7-0.85		0.78	
Coagulants	Methanol	DMA/water*	Methanol	DMA/water*
Draw ratio: air	15-20%	20-30%	20%	30%
hot water	10-12%	12-20%	12%	20%
Coagulation bath temp. °C	20-23	40-75	20-23	40-75

*composition: DMA/water, 75/25, v/v

(b) For production of high extensible fibres (>20%)

Conditions as in (a) except draw by 4% in a hot water bath and 15% in air.

TABLE 7.13: Summary of the properties of undrawn and drawn wet spun fibres

Dope concentration: 7% chitin; DMA-8% LiCl
Spinneret: 80 μm , 20 holes

Coagulant	Fibre diameter (μm)	Fibre count (dtex)	Tenacity T (g/dtex)	Extensibility E (%)	Tensile factor $TE^{\frac{1}{2}}$
<u>Undrawn</u>					
DMA/water, 75/25 at					
(a) 25°C	35	14	0.84	51	6.0
(b) 75°C	38	16	0.80	78	7.1
Methanol (21-23°C)	29-30	9-10	0.78-0.98	50-65	5.7-7.4
Water baths at 25°C	30-35	10-14	0.61-0.96	47-51	4.4-6.7
<u>1. Drawn in air (DR 4-30%)</u>					
DMA/water, 75/25 at					
(a) 25°C	34 ⁺	13	0.96	51	6.8
(b) 75°C	26-32	8-11	0.85-2.0	17-66	7.0-8.3
Methanol (21-23°C)	23-26	6-7	1.40-1.93	9-31	6.0-8.0
Butanol (25°C)	23-30	6-10	0.93-1.43	16-55	5.5-7.8
Water baths (25°C) ⁺	30	10	1.0	44	6.7
<u>2. Drawn in a hot water bath (DR 4-20%)</u>					
DMA/water, 75/25 at					
(a) 25°C	23-27 ⁺	6-8	1.4-1.6	9-18	4-6.3
(b) 75°C	25-30	8-10	1.3-2.12	14-41	7.3-8.5
Methanol (21-23°C)	23-25	6-7	1.5-1.91	12-22	6.6-7.0
Water baths					
(a) 5-25°C	24-27	6.5-8	1.2-1.42	26-32	6.8-7.3
(b) 75°C	29-35	10-13	0.86-1.37	34-67	7-9

⁺draw ratio 4%

7.3.3.2 Dry-jet wet-spinning

In comparison with wet spinning, dry-jet wet-spinning is said to have numerous advantages such as increases in fibre tenacity, extensibility, tensile factor, fibre lustre, smoothness and a reduction in fibre porosity. With these advantages in mind, dry-jet wet-spinning was studied soon after it was observed that variations in conditions using wet spinning did not improve the mechanical properties of the fibre as much as hoped. However, early studies of this unique spinning technique also failed to improve the mechanical properties of the fibres except where a high jet stretch ratio was used. Employment of high jet stretch ratios produced fibres that were generally very stiff, with low values of extensibility. Like wet spinning, it was also not possible to draw the fibres without running into spinnability problems due to constant filament breakages. Nevertheless, some improvement in the fibre lustre and smoothness was obtained from the fibres spun especially with a low jet stretch ratio of between 0.85 and 3. With the understanding that the lack of improvement in the mechanical properties of the fibre generally was due to the tension problems earlier discussed in this section, it became necessary to reinvestigate some of the important spinning variables studied during the preliminary work, now that a better understanding of the spinning procedure had been obtained.

For these reasons, it was decided to examine the following variables; air-gap distance between spinneret surface and coagulation liquid level, draw ratio, jet stretch ratio and extrusion rate. The method of fibre production was essentially the same as those described in section 2.4.4. The spinning conditions are listed in Table 7.15. As earlier discussed in the preliminary studies, it appeared that methanol

TABLE 7.15: Spinning conditions (samples 7-83 to 7-101)

Fixed conditions

Chitin:	as in Table 7.5 (solution aged for 7 days)
Pump and pot temperature:	25°C
Spinneret size:	300 µm, 10 holes
Hot draw bath temperature:	80-85°C
Pump speed:	5.3 rpm
Linear rate extrusion:	7.5 m/min
Coagulant:	Methanol except where otherwise indicated
Nitrogen pressure:	20 lb/in ²
Chitin concentration:	7% (w/w)
Lithium chloride concentration:	8%, (w/w)
One wrap on each roller	
Filaments stored in methanol for 2 hours	
Dried in a vacuum oven at room temperature overnight	

Variable conditions

First advancing reel speed:	6.4 m/min- 30.5 m/min
Second advancing reel speed:	8.3 m/min- 39.4 m/min
Air-gap distance:	0.5 - 4 cm

was one of the better coagulants. It was therefore decided to use methanol for all the experiments except where otherwise indicated.

Variable (i): effect of the air-gap

The results obtained are shown in Table 7.16 and Figs. 7.9-7.11, and show the effect of the air-gap on tenacity, extensibility, and tensile factor for air-gaps between 0.5 and 4 cm. At lower air-gaps than 0.5 cm, the coagulant tended to touch the surface of the spinneret at the slightest vibration of the coagulation bath. This resulted in fibre breakages as the filaments got pushed from one side to another in response to the liquid waves in the coagulation bath. On occasions fibre breakages occurred even at an air-gap of 0.5 cm without waves in the bath. Above 4 cm air-gap, it was not possible to prevent fibre coalescence (which mostly occurred in pairs) between neighbouring filaments in the air-gap region. This problem also occurred at almost every air-gap when jet stretch ratios of less than 1 were used. To spin without filament coherence at low jet stretch ratios and at air-gaps greater than 2 cm, it was found necessary to first gradually move the bath upwards to an air-gap of approximately 0.5 cm where the filaments separated beautifully and then to very slowly lower the bath to the required air-gap. The method did not work for air-gaps beyond 4 cm.

The results show that both the tenacity and tensile factor curves gave optimum values between 2 and 3 cm air-gaps. Above 3 cm, the values decreased sharply. The extensibility was almost constant between air-gaps of 0.5 and 2 cm, after which a sudden increase was observed. The reason for this behaviour was not clear, but it could indicate that the filaments were not effectively stretched at air-gaps

TABLE 7.16: Effect of the air-gap on fibre properties

Sample No.	Air-gap (cm)	Tenacity T (g/dtex)	S.D. σ_T	Extensibility E (%)	S.D. σ_E	Tensile factor $TE^{\frac{1}{2}}$
7-83	0.5	1.40	0.22	8.8	0.62	4.15
7-84	1.0	1.52	0.25	8.9	1.12	4.53
7-85	1.5	1.74	0.27	8.6	1.20	5.10
7-86	2.0	1.74	0.19	8.5	0.70	5.10
7-87	3.0	2.00	0.42	10.0	1.56	6.32
7-88	4.0	1.30	0.41	11.6	1.49	4.43

S.D. Standard deviation

Mean value based on 15 samples

Spinning conditions: First advancing reel speed: 21.7 m/min
 Second advancing reel speed: 28.2 m/min
 Draw ratio: 30%
 Jet stretch ratio: 2.87

Average fibre count: 20.5 dtex

Average fibre diameter: 43 μm

FIG. 7.9: Effect of the air-gap on tenacity
(DJWS into methanol)

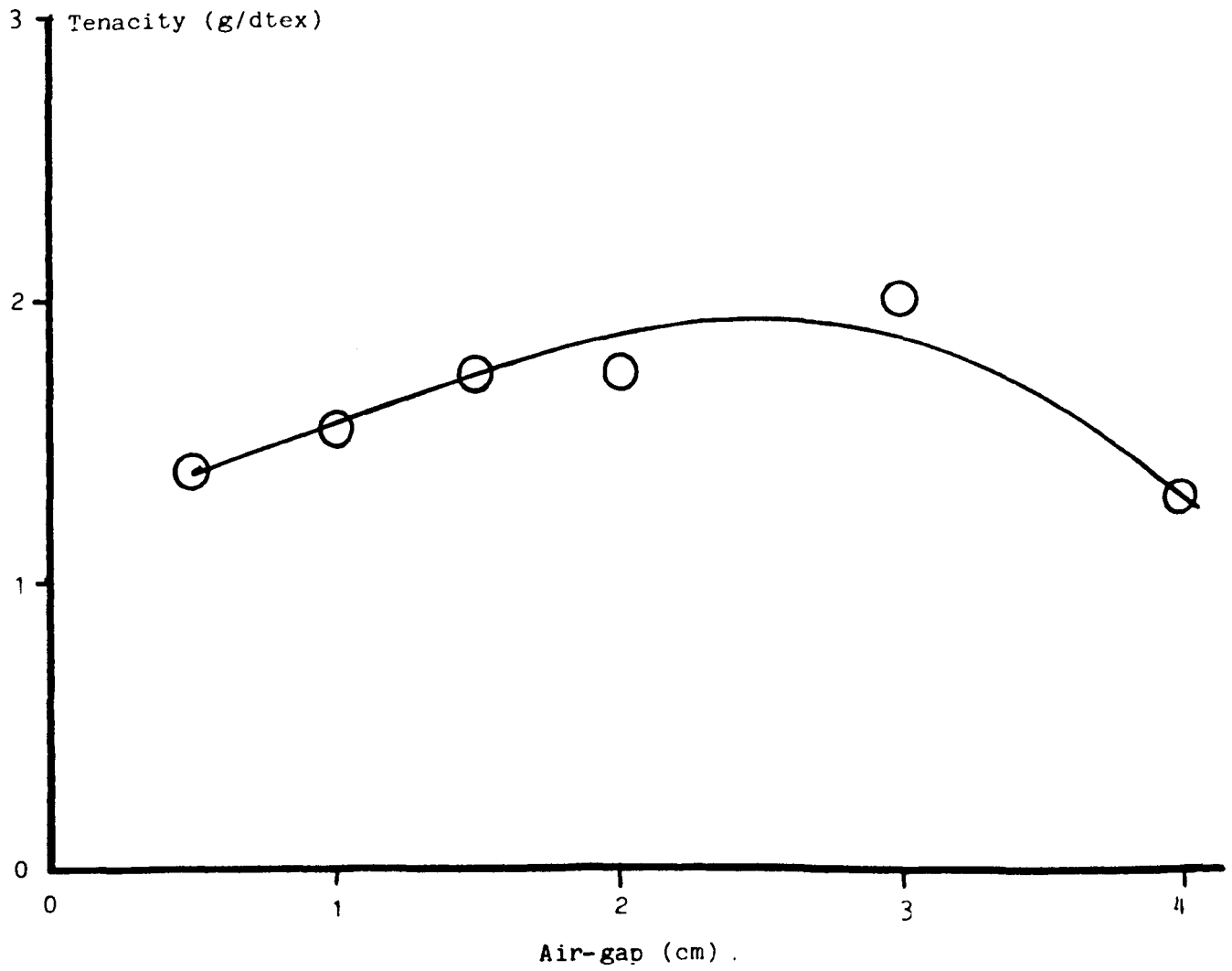

FIG. 7.10: Effect of the air-gap on extensibility
(DJWS into methanol)

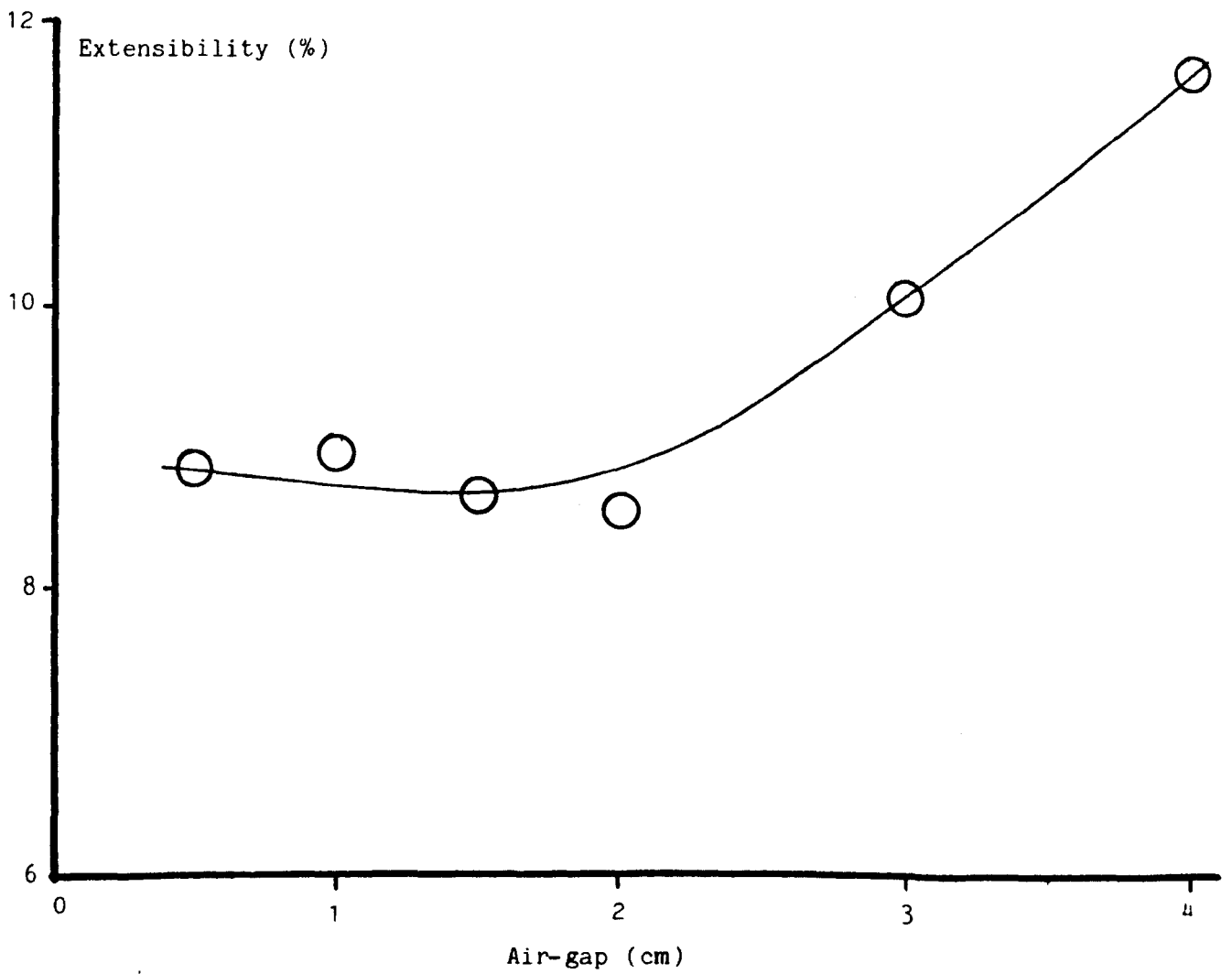
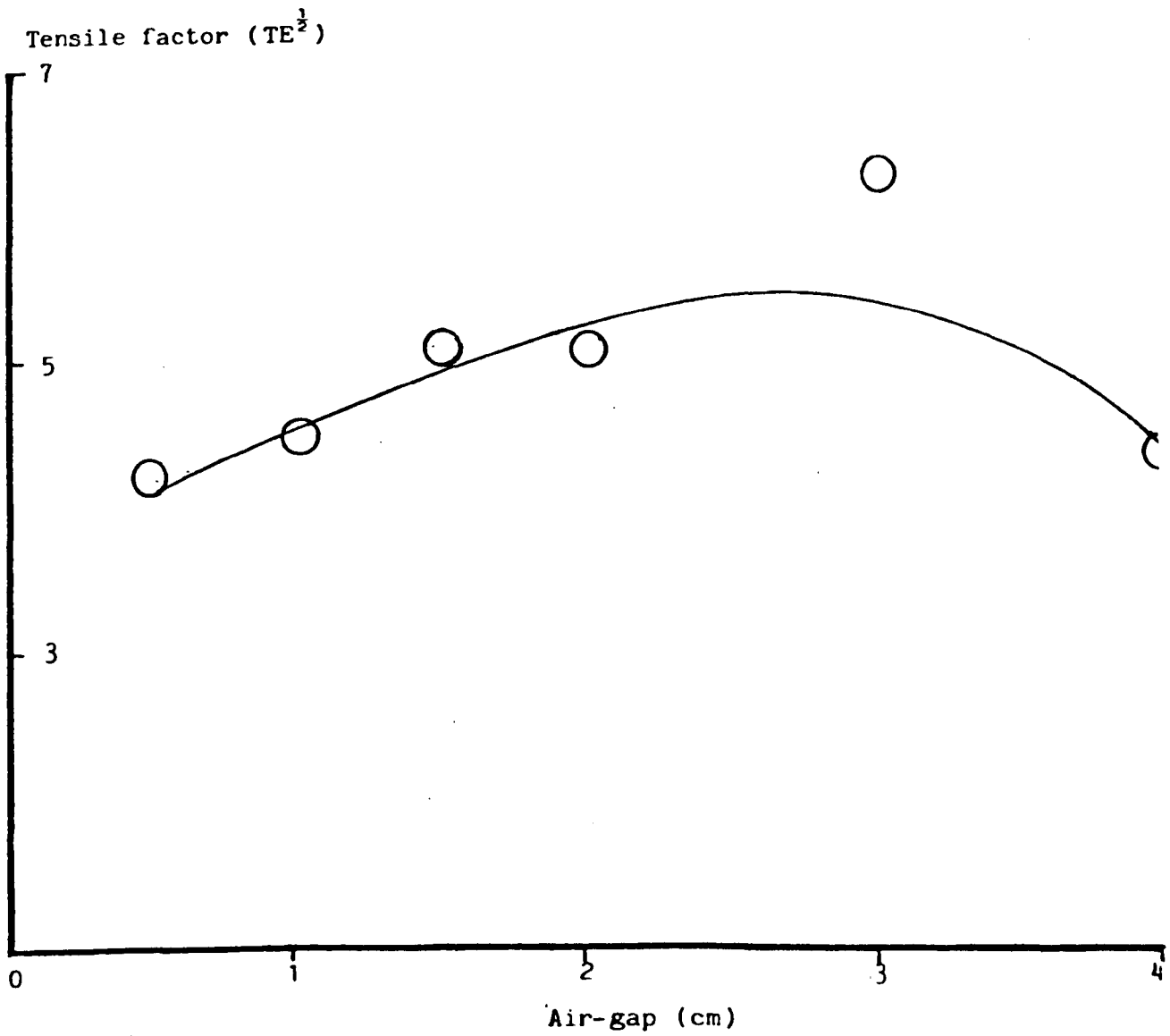

FIG. 7.11: Effect of the air-gap on tensile factor
(DJWS into methanol)



beyond 2 cm. It could also be due to a greater relaxation of the filaments at increasing air-gaps from the rheological stresses and strains imposed on the solution as it was forced through the spinneret holes. These reasons could also explain the somewhat higher fibre irregularity observed beyond an air-gap of 2 cm. The variability from the mean of tenacity and extensibility measurements expressed in terms of standard deviation is shown in Table 7.16. Although these variations were generally small it can be seen that they tend to increase with increasing air-gap. The variability in extensibility measurements was found to be greater than in tenacity measurements. When expressed as C.V.% (defined as $\frac{\text{standard deviation} \times 100}{\text{mean}}$), the variability in tenacity measurements was between 0.14 and 0.30% and extensibility 2 and 4%.

Variable (ii): the effect of jet stretch ratio

Table 7.17 shows the effect of the jet stretch ratio on the mechanical properties of the fibres drawn by 30% in hot water or air. The use of such a high DR limited the jet stretch ratio obtainable to a maximum of ~ 4 . Figure 7.12 shows the curves of the effect of jet stretch ratio on tenacity, and extensibility. The results indicate that as the jet stretch ratio increases, the extensibility and tensile factor decrease while it appears that the tenacity has a maximum value around a jet stretch ratio of 3. Above a jet stretch ratio of 4, it became difficult to maintain a continuous spinning at the 30% draw ratio used.

In comparison with the results of the preliminary studies of the effect of jet stretch ratio on undrawn fibres (section 3.2.3), it can be seen that while the effect of drawing has reduced the extensibility at a jet stretch ratio of 0.85 from 34 to 13%, the tenacity has increased

TABLE 7.17: Effect of jet stretch ratio on fibre properties

Sample No.	Jet stretch ratio	Fibre diameter (μm)	Fibre count (dtex)	Tenacity T (g/dtex)	Extensibility E (%)	Tensile factor $TE^{\frac{1}{2}}$
3-47*	0.85	100.0	109.5	0.94	34.0	5.5
7-89	"	84.0	77.0	1.58	13.1	5.70
7-85	2.87	42.4	19.6	1.74	8.6	5.10
7-90	"	(42.0)	(19.0)	(1.91)	(11.9)	(6.60)
7-91	4.00	35.5	13.8	1.80	6.8	4.70
7-92	"	(35.0)	(13.4)	(1.72)	(9.9)	(5.40)
3-50*	"	41.2	17.8	1.38	22.3	5.2

() drawn in air

Spinning conditions: Draw ratio: 30%
Air-gap distance: 1.5 cm

* undrawn (data from Table 3.9)

FIG. 7.12: Effect of jet stretch ratio on tenacity and extensibility of drawn fibres
(DJWS into methanol)

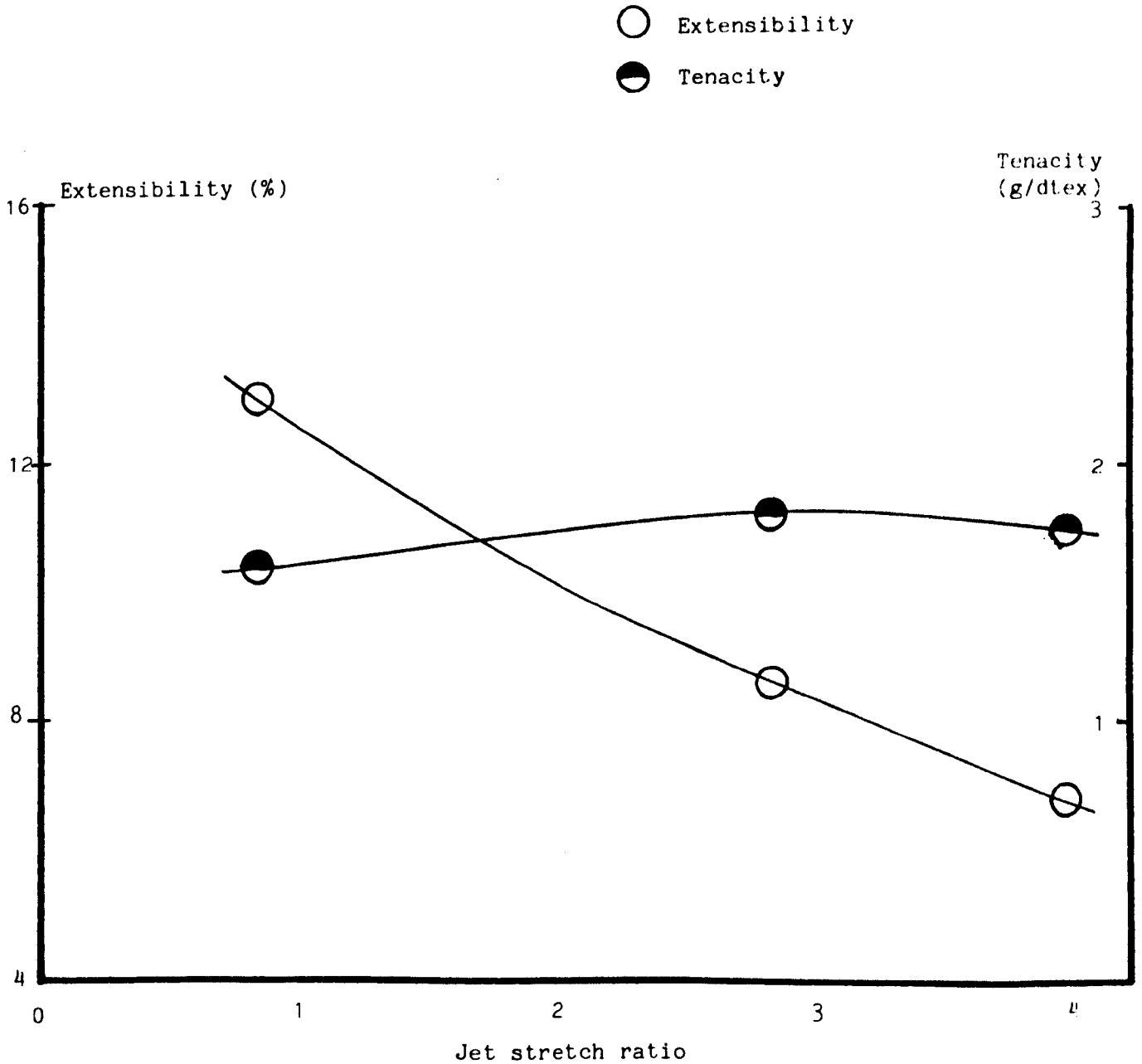

from 0.94 to 1.58 g/dtex. On the other hand, the value of extensibility at a jet stretch ratio of 4 was reduced from 22 to 7% and tenacity increased from only 1.38 to 1.73 g/dtex. This indicates that it is better to use a moderate jet stretch ratio of between 0.85 and 2 and draw, rather than use a high jet stretch.

An interesting result was noted for samples drawn in air. Apart from slightly higher values of extensibility and tensile factor than were obtained from the samples drawn in water, the tenacity around the region of moderate jet stretch ratios was also higher. This might be important because drawing in air, apart from its simplicity (no guides or heaters required) produced a more continuous spinning operation than in hot water.

Variable (iii): effect of drawing and extrusion rate

One of the main advantages dry-jet wet-spinning has over wet spinning is the claim that fibres that are dry-jet wet-spun can be drawn at higher draw ratios than those wet spun [197,198]. The higher draw ratios employed indicate higher fibre attenuation and tenacity. It was decided therefore to study the effect of draw ratio on the fibre properties. Table 7.18 shows the results obtained using draw ratios between 10 and 40%. The maximum draw ratio that the fibres could withstand was 40%, and even at this ratio two to three breakages were encountered within about 5 minutes spinning time. Figures 7.15 and 7.16 show the effect of draw ratio on fibre tenacity and extensibility. It is clear from these results that increasing the draw ratio decreases extensibility and increases tenacity. Overall there was very little effect on the tensile factor. However, the decrease in extensibility appeared to occur only between 10 and 30% draw ratio; beyond this

TABLE 7.18: Effect of draw ratio and linear extrusion rate on fibre properties (DJWS)

Sample No.	Coagulant	Linear extrusion rate (m/min)	Draw ratio (%)	Fibre diameter (μm)	Fibre Count (dtex)	Tenacity T (g/dtex)	Extensibility E (%)	Tensile factor $TE^{\frac{1}{2}}$
7-93	Methanol	7.6	10	47.6	24.7	1.21	24.0	5.90
7-94			20	44.4	21.5	1.50	13.2	5.50
7-85			30	42.4	19.6	1.74	9.2	5.25
7-95			40	40.6	18.0	1.85	8.5	5.40
7-96	DMA/water 75/25, v/v (75°C)	7.6	30	45.0	22.0	1.50	9.7	4.70
7-97				(47.0)	(24.0)	(1.17)	(13.7)	(4.30)
7-98	Butanol	7.6	30	(47.40)	(24.0)	(1.13)	(22.0)	(5.30)
7-99	Methanol	4.2	30	42.5	19.7	1.83	9.9	5.76
7-100		8.8	30	44.0	20.2	1.51	8.9	4.50
7-101		14.2	30	44.0	20.2	1.55	12.0	5.37

() drawn in air

Spinning conditions: Air-gap distance: 1.5 cm
 Jet stretch ratio: 2.87

FIG. 7.13: Effect of drawing on tenacity
(DJWS into methanol)

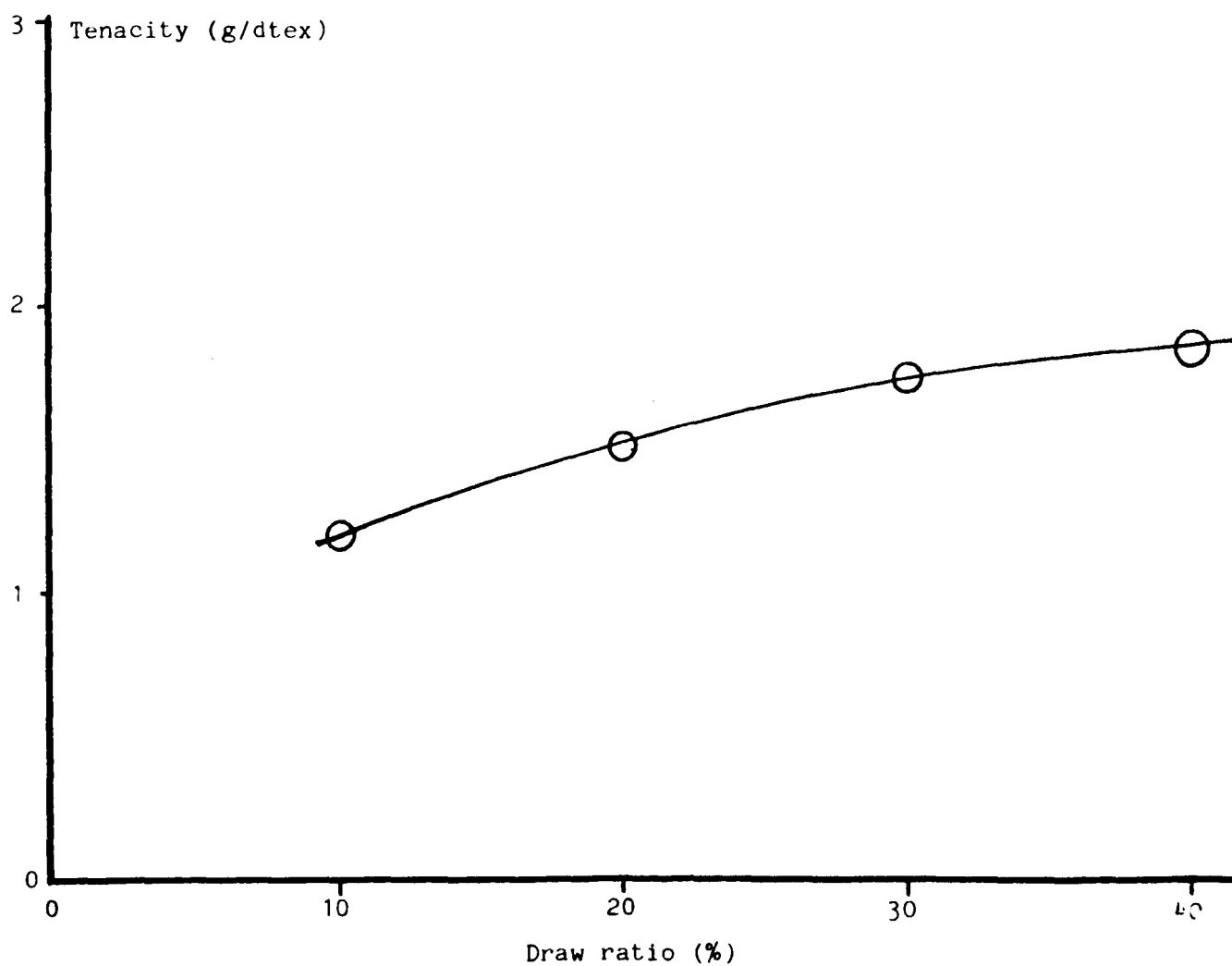
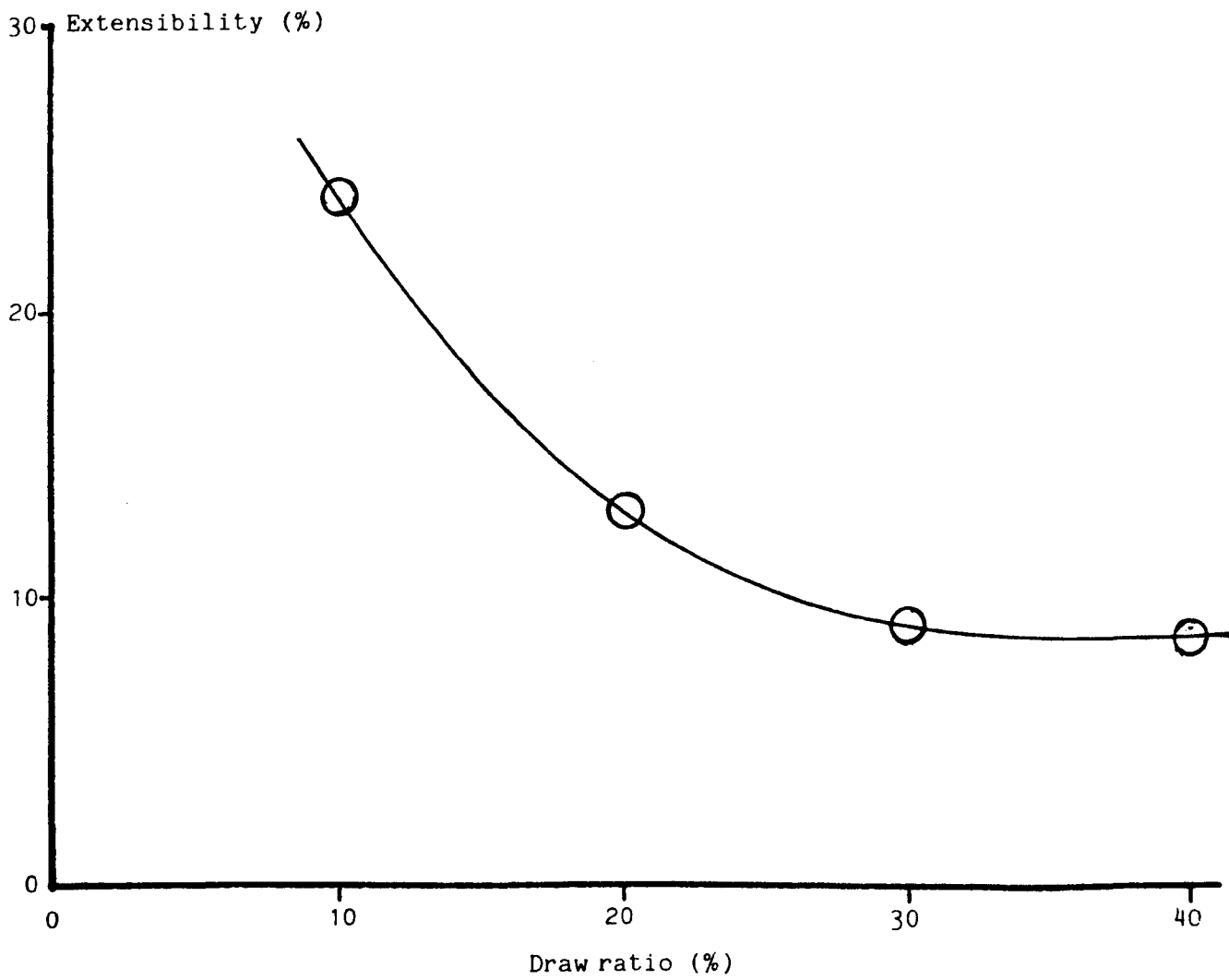

FIG. 7.14: Effect of drawing on extensibility
(DJWS into methanol)



ratio no change was observed. A close examination of the results also shows that the increase in tenacity, though progressive, appears to reduce with increasing draw ratio. Although the fibre tenacity increased as the draw ratio was increased, the maximum draw ratio the fibres could withstand was only a little better than the value obtained for wet spinning.

The results obtained when using DMA/water, 75/25 at 75°C showed that the fibre properties were worse than when wet spun under similar conditions, though of course the dry-jet wet-spinning used a larger hole size spinneret and produced a coarser filament. At the draw ratio used, it was not possible to spin with this coagulation bath at room temperature (section 7.3.3.1). When butanol was used, drawing in hot water at 30% draw ratio was also impossible as the fibres broke frequently in the draw bath. However, drawing in air at the same draw ratio was found to be satisfactory though the fibres could not accept any draw ratio higher than 30%.

Table 7.18 also shows the effect of changes in the linear extrusion rate on the fibre properties using a 30% draw ratio and a jet stretch ratio of 2.87. From the results it is obvious that the fibre tenacity was higher at the linear rate of extrusion of 4.2 m/min and constant between 8 and 14.2 m/min. At 14.2 m/min, it was very difficult to carry out spinning as the rollers had to be set at such very high speeds.

The following summary was made about dry-jet wet-spinning of chitin fibres:

- (i) It was found easier to dry-jet wet-spin using methanol as a coagulant than 75% DMA or butanol, even when the DMA bath was at about

75°C. Fibres spun into methanol were also found to be stronger than those spun using the other two baths.

(ii) Although fibres can be spun at air-gaps between 0.5 and 4 cm, best results were obtained between 2 and 3 cm air-gap. In this region, optimum results were obtained for tenacity and tensile factor. Generally, extensibility was found to increase with increasing air-gap.

(iii) At a draw ratio of 30%, the maximum jet stretch ratio obtainable was about 4. This is lower than the value of 6 obtained (with the 300 µm diameter spinneret) previously in the preliminary experiments. While the fibre extensibility decreased as expected with increasing jet stretch ratio, it only had a slight effect on fibres drawn in a hot water bath. However, it appeared generally that jet stretch ratios higher than about 3 caused the properties of the fibres to deteriorate.

(iv) As usual the tenacity increased and extensibility decreased as the draw ratio was increased, though the difference in extensibility between draw ratios 30 and 40% was surprisingly very small. At a jet stretch ratio of about 3, the maximum draw ratio attainable was about 40%.

(v) Considering the level of improvements reported with other spinning systems using DJWS technique, it is clear from the results obtained in the present work that DJWS is not really a very beneficial technique.

The summary of the fibre properties and best spinning conditions obtained are shown in Table 7.19.

TABLE 7.19: Summary of the properties of drawn dry-jet wet-spun fibres using methanol as coagulant

Fibre diameter (μm):	36-84
Fibre count (dtex):	14-77
Tenacity T, (g/dtex):	1.2-2.0; 1.2-1.50*; 1.13**
Extensibility E, (%):	7-24; 10-14*; 22**
Tensile factor ($TE^{\frac{1}{2}}$):	4.4-6.6; 4.3-4.7*; 5.3**

* DMA/water, 75/25 (75°C)

** Butanol

Best spinning conditions

Air gap:	1-3 cm
Jet stretch ratio:	2-3
Draw ratio (%):	20-30
Extrusion rate:	4.2 m/min (pump capacity 1 cc/rev)
Spinneret:	300 μm , 10 hole
Coagulant:	Methanol
Drawing medium:	Air or hot water bath
Dope concentration:	7% (w/w) chitin; 8% (w/w) LiCl

7.3.4 Electron micrographs of drawn fibres

Plates 7.11-7.34 show the electron micrographs of some selected drawn samples. Plates 7.11-7.25 were wet spun (spinning conditions Table 7.5), while Plates 7.26-7.34 were dry-jet wet-spun (spinning conditions Table 7.15). Examining the wet spun samples first of all indicates a change in the surface features from the very rough surfaces earlier shown (Plates 7.1-7.7) for the undrawn fibres. Excepting the sample spun into a water bath (75°C) and drawn in air by 30%, all the other samples are more or less smooth, though part of the fibre surface in Plate 7.20 appeared to have peeled. In fact, fibres spun into DMA/water, 75/25, or methanol baths and drawn by 4% or more in hot water were observed to be lustrous with the lustre increasing as the draw ratio increased. Similar samples, drawn in air by about 20% (methanol bath) or 20-30% (DMA/water, 75/25 bath) were also lustrous. Plates 7.11-7.13 were arranged to show progressively the effect of increasing the DMA/water (75/25) bath temperature. It appears that the fibre surface smoothness increases with increasing bath temperature. Besides, at bath temperatures of 25°C and 35°C, the samples (Plates 7.11 and 7.12) appear to possess a fibrillar surface.

As for fibres spun into water or butanol baths, and drawn in air or in a hot water bath, the surface features (eg. Plate 7.24) were almost as rough as those of the undrawn fibres. This explains why fibres spun into these baths were always dull even at high draw ratios.

The cross-section of all the wet spun fibres as well as those dry-jet wet-spun look more nearly circular, with no apparent signs of macrovoids. However, all of the sections except Plates 7.14 and 7.15 appeared to have crumbled at their edges, indicating the brittle nature

of the fibres. The crumbling can be avoided by careful sectioning with a new razor blade.

The surface structure in the dry-jet wet-spun fibres (Plates 7.26-7.31), looks very smooth, especially those spun at high jet stretch ratio of 2.85 and 4. In the preliminary studies, undrawn fibres produced at a low jet stretch ratio of 0.85 using a water bath at pH 3.4 were extremely smooth. The reduced smoothness obtained here was perhaps due to fibre coherence in the methanol bath at this jet stretch ratio.

PLATES 7.11-7.34: ELECTRON MICROGRAPHS OF DRAWN WET AND
DRY-JET WET-SPUN CHITIN FIBRES

- Plates 7.11-7.13: Effect of bath temperatures on the surface structure of wet spun fibres
- Plates 7.14 and 7.15: Effect of bath temperatures on the cross-section of wet spun fibres
- Plates 7.16-7.19: Surface structure and cross-section of wet spun fibres spun into 75% DMA (75°C)
- Plates 7.20-7.23: Surface structure and cross-section of wet spun fibres spun into methanol
- Plates 7.24 and 7.25: Surface structure and cross-section of wet spun fibres spun into a water bath at 75°C
DR: 30% (air)
- Plates 7.26-7.34: Surface structure and cross-section of DJWS fibres
Coagulant: methanol
DR: 30% (hot water)

PLATES 7.11-7.13: Effect of bath temperature on the surface structure of wet spun fibres

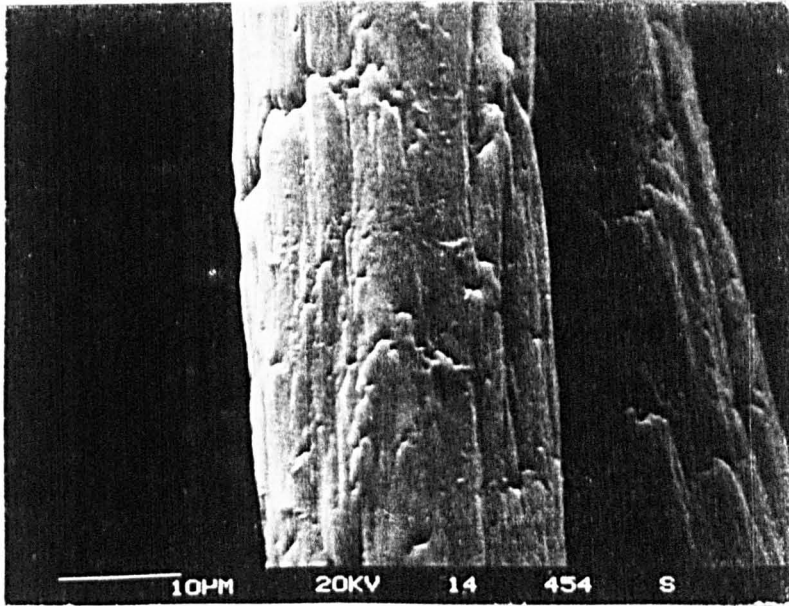

Plate 7.11 (WS)
75% DMA(25°C)
DR: 12% (hot
water)

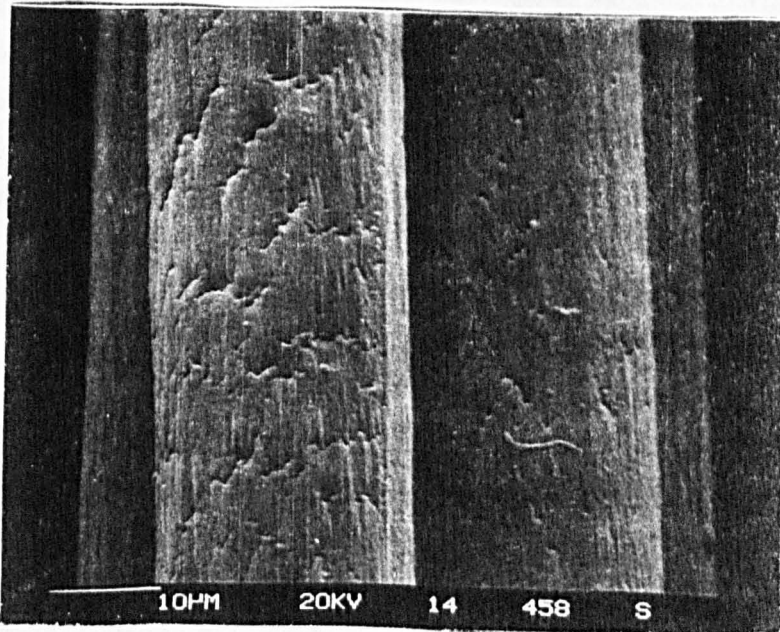

Plate 7.12(WS)
75% DMA(35°C)
DR: 12% (hot
water)

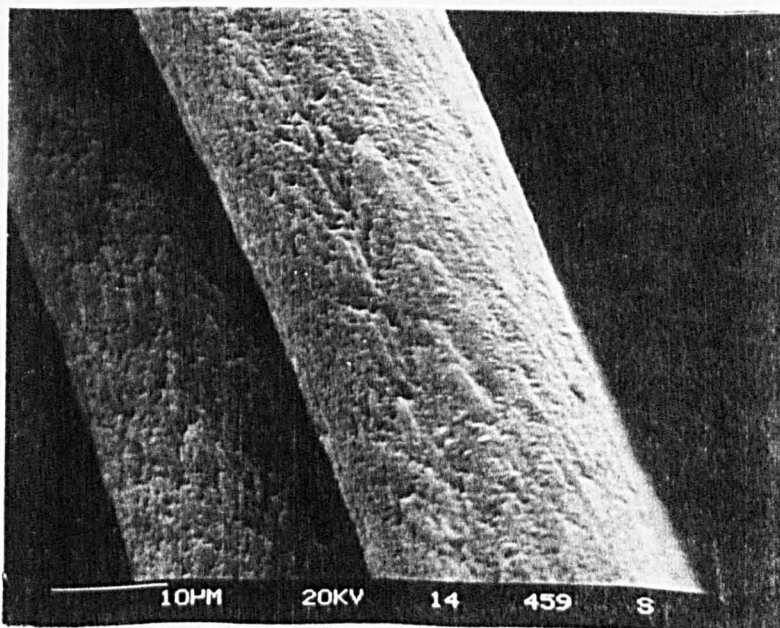

Plate 7.13(WS)
75% DMA(75°C)
DR: 12% (hot
water)

PLATES 7.14 and 7.15: Effect of bath temperatures on the cross-section of wet spun fibres

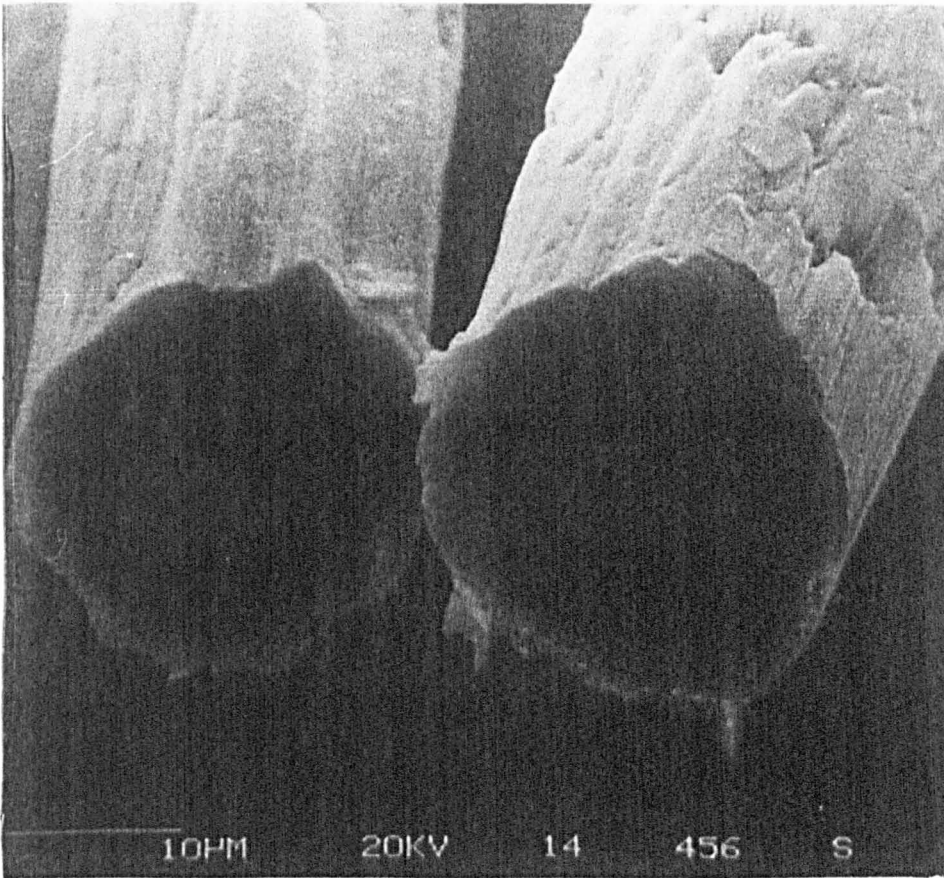

Plate 7.14(WS)
75% DMA (25°C)
DR: 12% (hot
water)

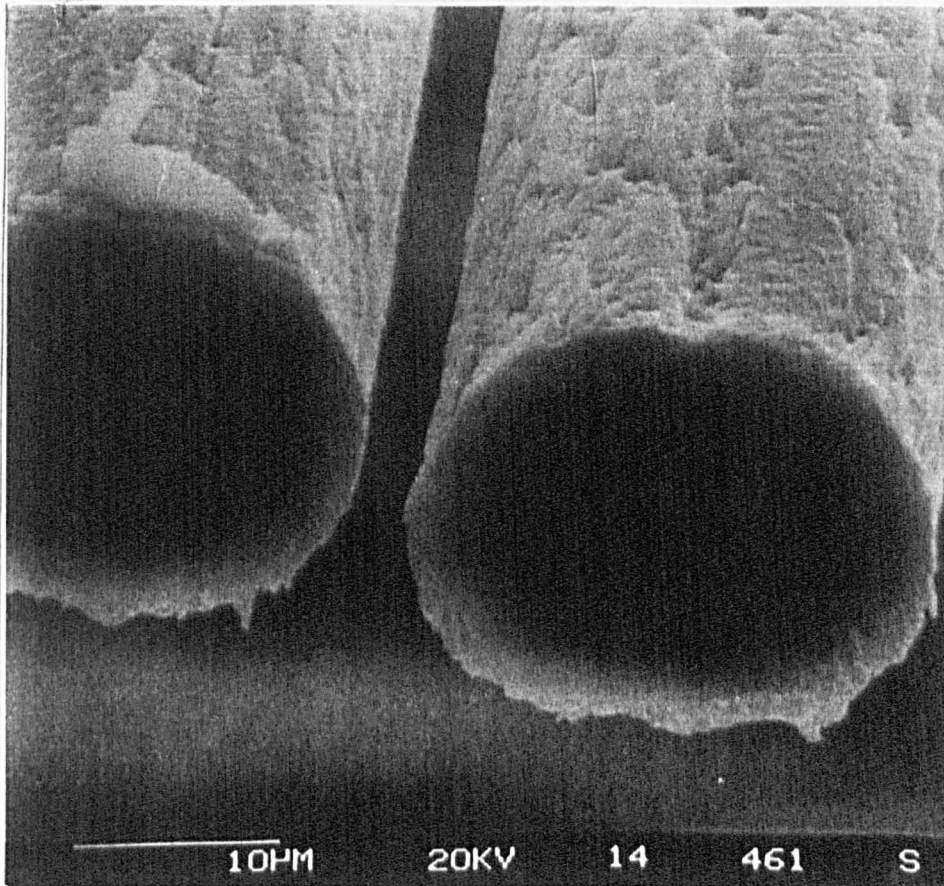

Plate 7.15(WS)
75% DMA (75°C)
DR: 12% (hot
water)

PLATES 7.16-7.19: Surface structure and cross-section of WS fibres spun into 75% DMA (75°C)

Plates 7.16 and 7.17: DR. 20% (hot water)

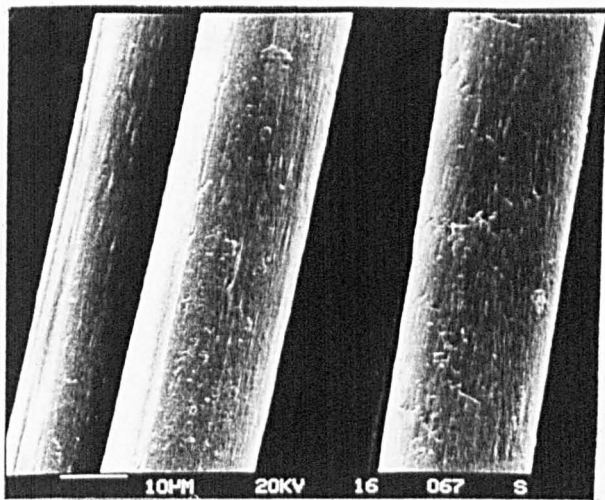

Plate 7.16

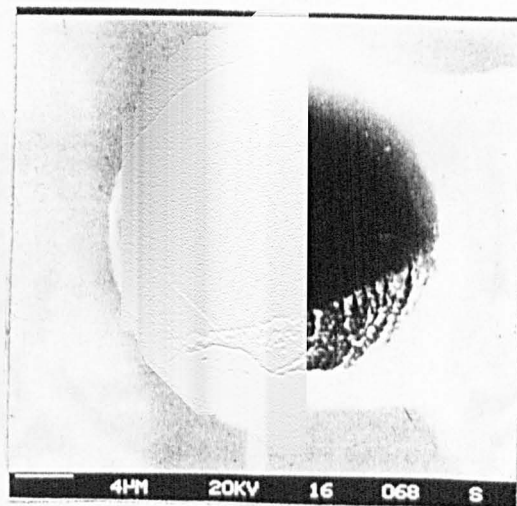

Plate 7.17

Plates 7.18 and 7.19: DR. 30% (air)

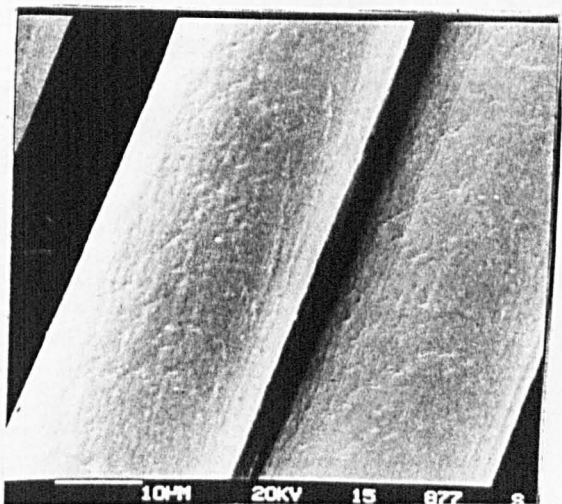

Plate 7.18

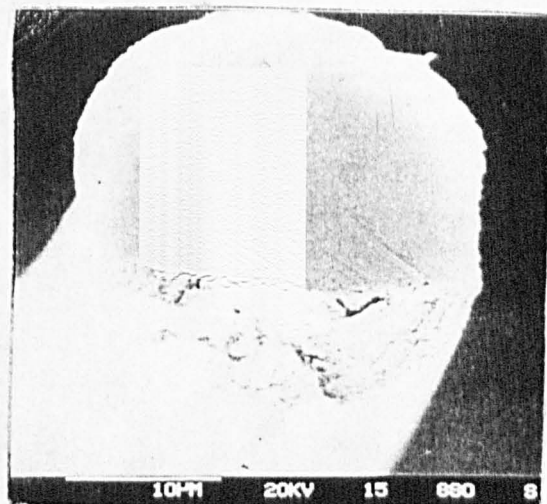

Plate 7.19

PLATES 7.20-7.23: Surface structure and cross-section of WS fibres spun into methanol

Plates 7.20 and 7.21: DR. 12% (hot water)

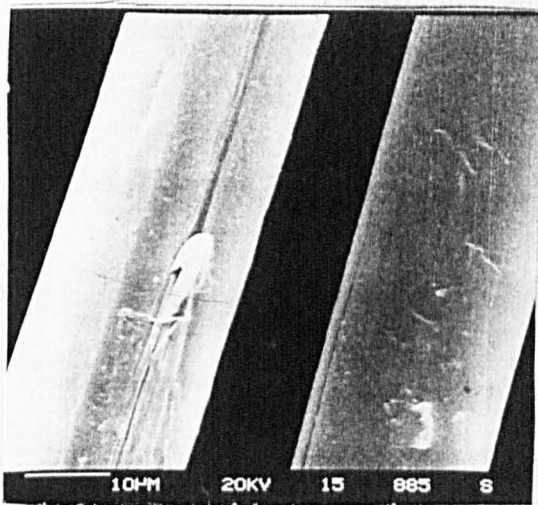

Plate 7.20

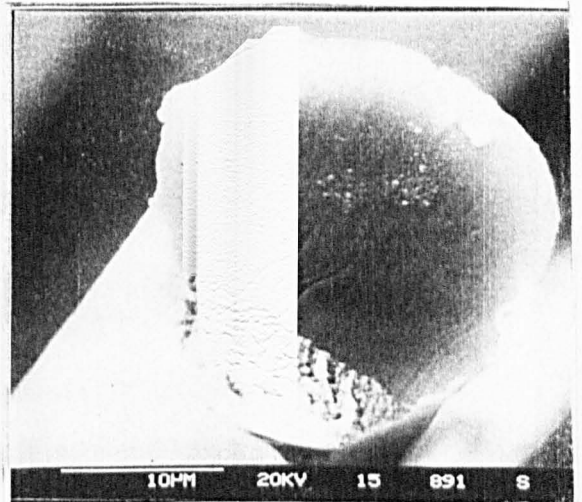

Plate 7.21

Plates 7.22 and 7.23: DR. 20% (air)

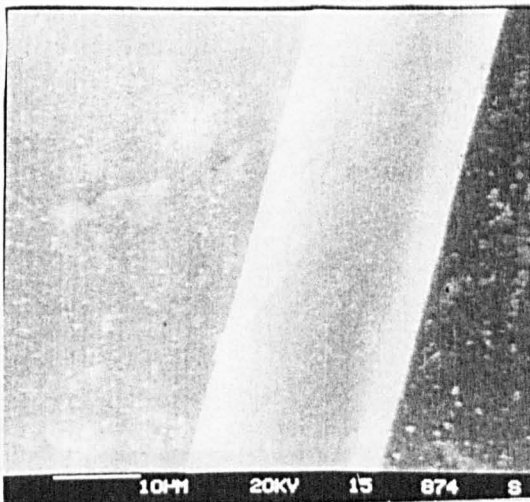

Plate 7.22

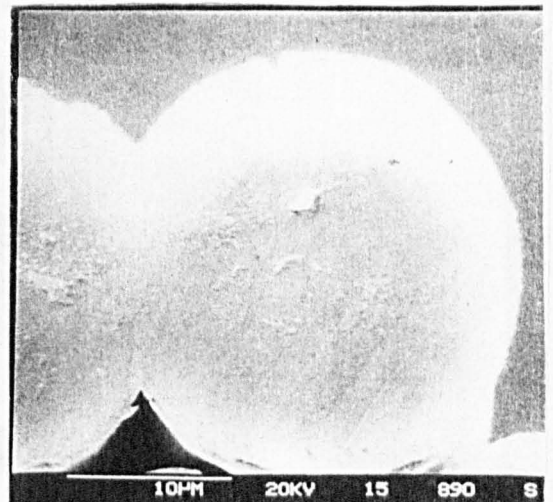

Plate 7.23

PLATES 7.24 and 7.25: Surface structure and cross-section of WS fibres spun into a water bath at 75°C DR. 30% (air)

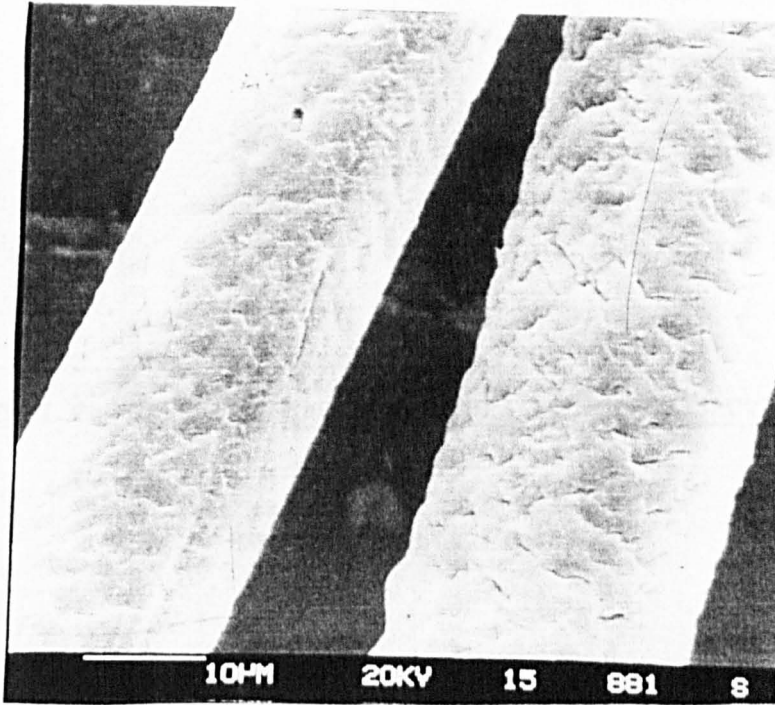

Plate 7.24

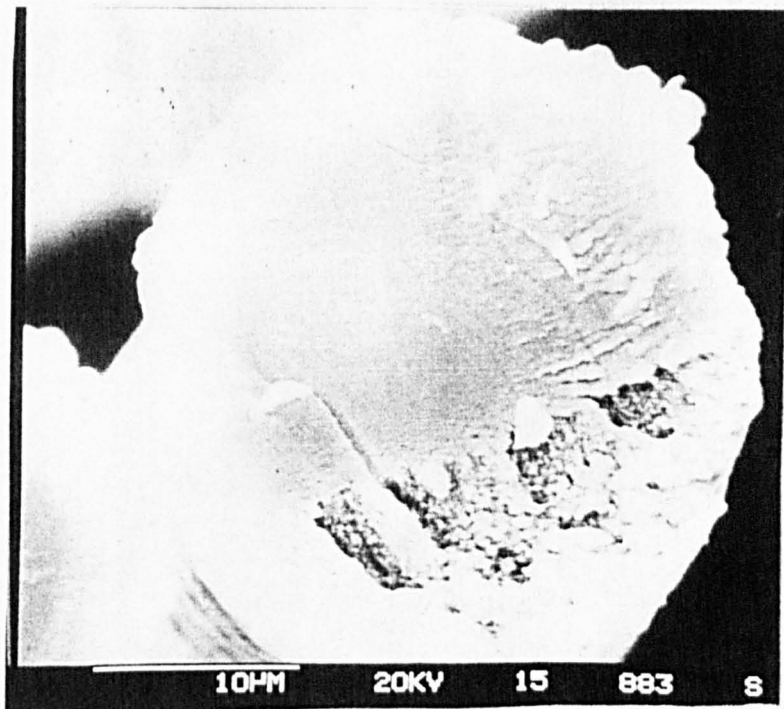

Plate 7.25

PLATES 7.26-7.34: SURFACE STRUCTURE AND CROSS-SECTION
OF DJWS FIBRES

Coagulation: methanol
DR. 30% (hot water)

Plates 7.26-7.28: Surface texture of DJWS fibres

Plates 7.29-7.31: Surface texture of DJWS fibres

Plates 7.32-7.34: Cross-section and surface texture
of DJWS fibres

PLATES 7.26-7.28:
Surface texture of
DJWS fibres

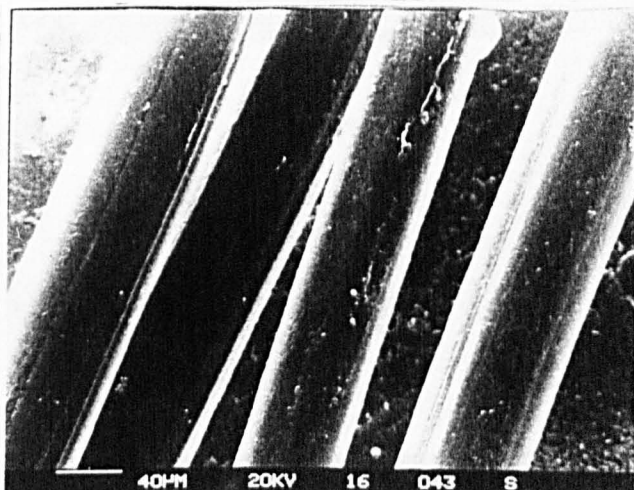

Plate 7.26

JSR: 0.85

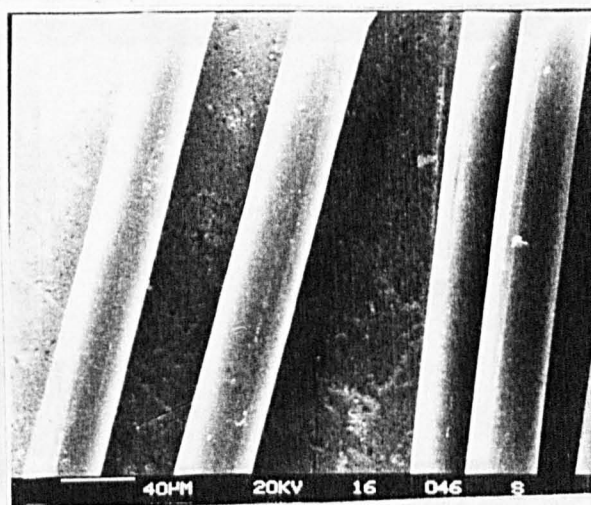

Plate 7.27

JSR: 2.87

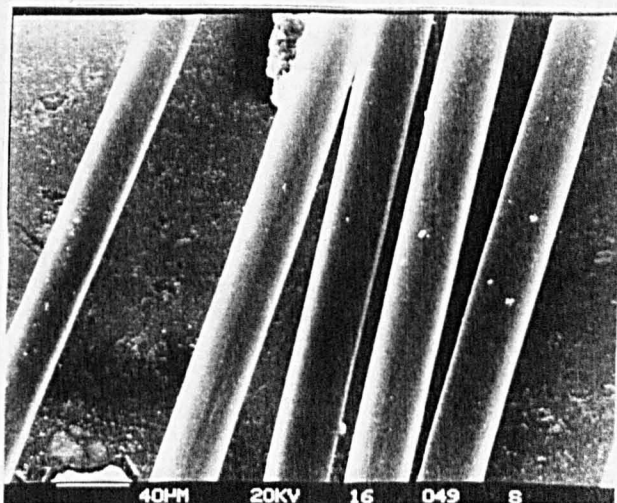

Plate 7.28

JSR: 4

PLATES 7.29-7.31:
Surface structure of
DJWS fibres

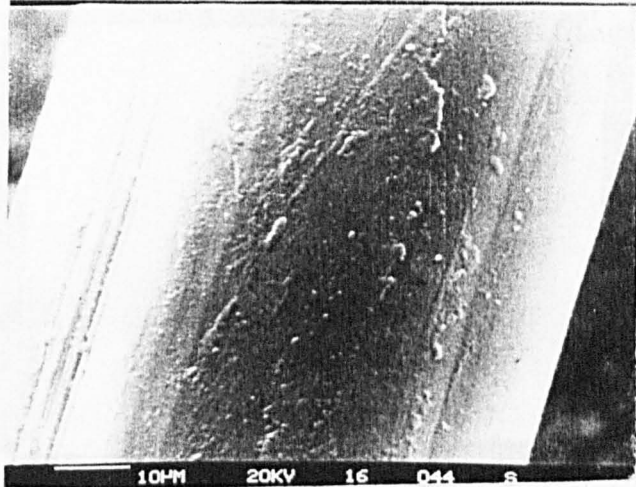

Plate 7.29
JSR: 0.85

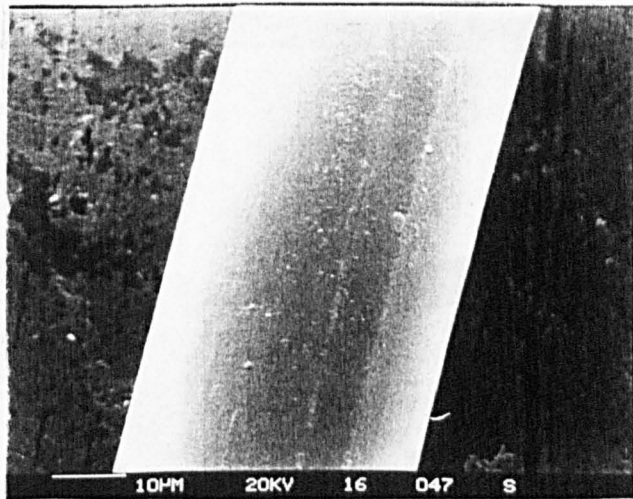

Plate 7.30
JSR: 2.87

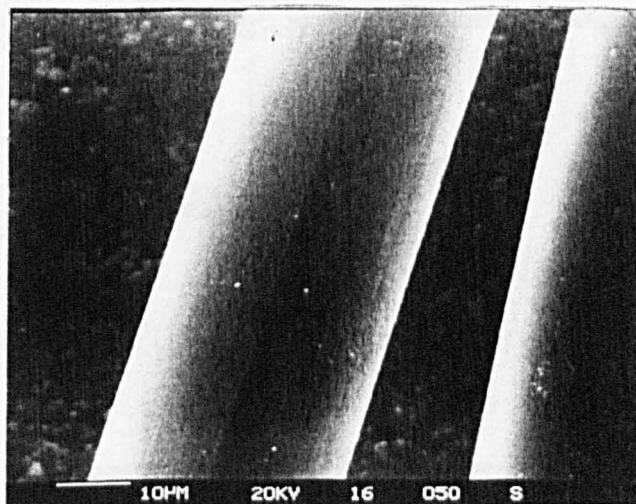

Plate 7.31
JSR: 4

PLATES 7.32-7.34:

Cross-section and
surface structure
of DJWS fibres

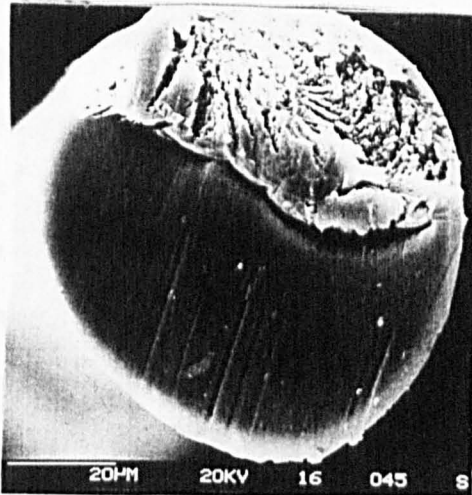

Plate 7.32

JSR: 0.85

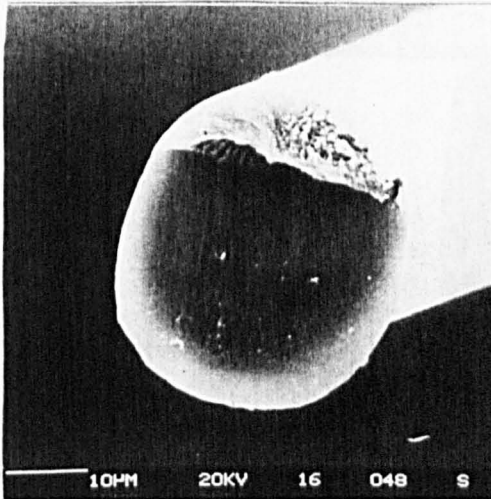

Plate 7.33

JSR: 2.87

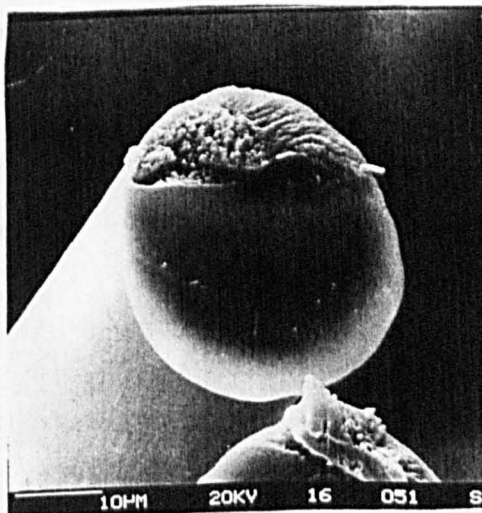

Plate 7.34

JSR: 4

7.3.5 X-ray diffraction patterns of drawn chitin fibres

Plates 7.35-7.43 show wide angle X-ray patterns of some of the drawn wet and dry-jet wet-spun samples. (In all the plates, fibre axes are vertical.) Almost all the samples were calibrated using a silver foil. The aim was to enable an estimate of the unit cell dimensions which would automatically establish the crystalline form of the fibres (ie. α -, or β -, or τ -chitins). Consequently, the two outer rings in the patterns are due to silver foil.

All the patterns (except Plate 7.37) show sharp reflections along the fibre axis, indicating a high orientation as a result of drawing. Furthermore, in comparison with the undrawn samples (Plates 7.9 and 7.10), those drawn were more highly crystalline since they appeared to have not only shorter but narrower and better defined arcs. However, within the drawn fibres the degree of orientation and, more or less, the crystallinity, as might be expected, appears to vary depending on the method of spinning, draw ratio, coagulant, drawing medium (mainly when drawn at 4% draw ratio) and jet stretch ratio (for DJWS). A comparison of Plate 7.43 with Plates 7.35-7.41 indicates that the reflections in the latter samples (wet spun) had slightly longer arcs and therefore were characteristic of less oriented fibres than those given by the former (DJWS fibres at JSR 4). Surprisingly, the higher orientation in this sample was not reflected in the value of tenacity shown in Table 7.17 (sample No. 7.91). However, it appeared that the higher orientation in this case, was a direct result of the increase in jet stretch ratio (see section 3.2.3), since the diffraction patterns obtained at a lower jet stretch ratio of 0.85 (Plate 7.42) compared very well with most wet spun samples except for those shown in

Plates 7.37, 7.38 and 7.41. The ineffectiveness of drawing the fibres in air at jet stretch ratios of 4%, mentioned earlier, was further evidenced in Plate 7.37; here the diffuseness of the reflections was highly marked. In fact, the fibres were only very slightly oriented. Plate 7.38, in contrast, shows that a similar fibre drawn in a hot water bath by 4% has reflections which are only slightly diffuse. A verification of the fibre properties obtained when water (75°C) was employed as coagulant is illustrated in Plate 7.41. The degree of orientation observed at such a draw ratio (30%) was less than for other samples drawn by 12% or more, implying some loss in orientation after drawing. This is characterised also by the furrowed surface and higher extensibility compared to, for example, the equivalent 75% DMA fibres. Fibres spun into methanol and 75% DMA were observed to have similar diffraction patterns (Plates 7.35, 7.36, 7.39 and 7.40).

In all cases, the equatorial reflections were highly diffuse, indicative of only slight order in the longitudinal axis of the fibres.

The most important outcome of the X-ray diffraction studies was the determination of the unit cell dimensions of the repeating unit in chitin fibres. The dimensions were kindly calculated by I. Karacan in this department. The results obtained for the main reflections observed are shown in Table 7.20. The d-spacings obtained were similar to those for α -chitin quoted by Blackwell et al [44] and Paralikar and Balasubramanya [199]. For an α -chitin, Blackwell et al [44] quoted the following dimensions based on an orthorhombic unit cell: $a = 4.74 \text{ \AA}$, $b = 18.86 \text{ \AA}$, $c = 10.32 \text{ \AA}$ (fibre axis). In the present work, the following dimensions were obtained: $a = 4.70 \text{ \AA}$, $b = 18.87 \text{ \AA}$, $c = 10.05 \text{ \AA}$ (fibre axis). Although the spacing of 10.05 \AA along the fibre is smaller

TABLE 7.20: Observed d-spacings for drawn chitin fibres

Reflections	h k l	Intensity (visual)	d(obs.) Å
Equatorial	020	strong	9.435
	110	very strong	4.557
Meridional	002	strong	5.002
	003	very strong	3.316

where d = the distance (spacing) between successive identical planes of atoms in the crystal

= the angle between the X-ray beam and these atomic planes

h, k and l are indices of the plane

The observed d-spacings were indexed based on an orthorhombic unit cell. The dimensions obtained are:

a	4.70 Å	present work
b	18.87 Å	
c	10.05 Å	
a	4.74 Å	Blackwell et al
b	18.86 Å	
c	10.32 Å	

than those quoted for chitin in the literature, it is similar to the value of 10.1 Å claimed by Tokura et al [93] for chitin fibre obtained from a chitin-formic acid solution.

PLATES 7.35-7.43: X-RAY DIFFRACTION PATTERNS - WET (WS) AND
DRY-JET WET-SPUN (DJWS) CHITIN FIBRES

Plates 7.35-7.41: Wet spun

Plates 7.42 and Dry-jet wet-spun
7.43

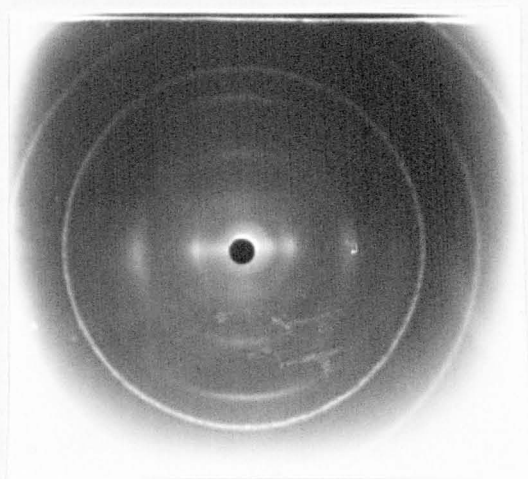

Plate 7.35 (WS)
Coag. 75% DMA (25°C)
DR. 12% (hot water)

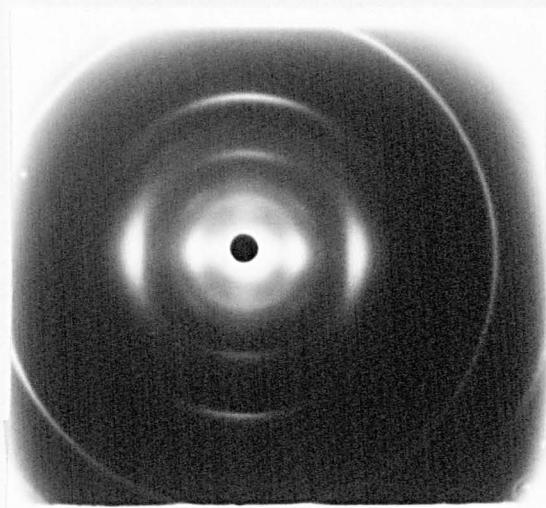

Plate 7.36 (WS)
Coag. 75% DMA (75°C)
DR. 20% (hot water)

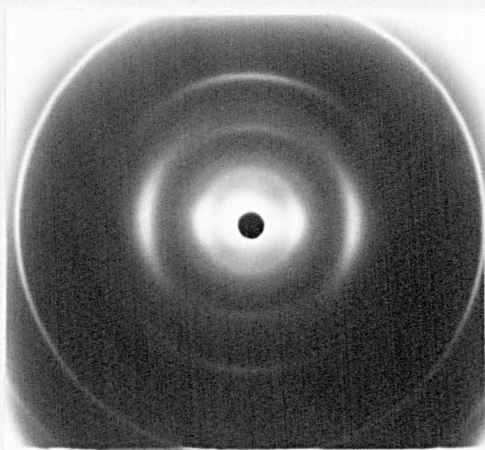

Plate 7.37 (WS)
Coag. methanol
DR. 4% (air)

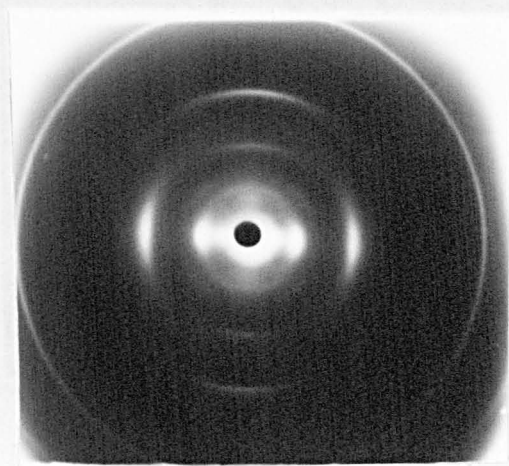

Plate 7.38 (WS)
Coag. methanol
DR. 4% (hot water)

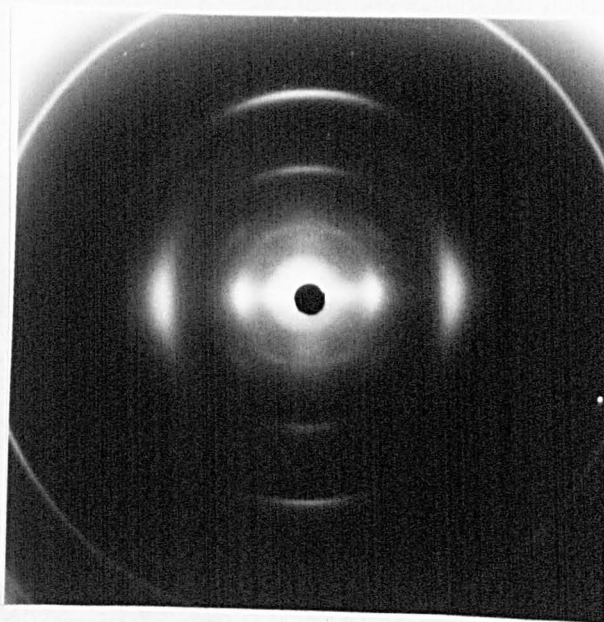

Plate 7.39 (WS)
Coag. methanol
DR. 12% (hot water)

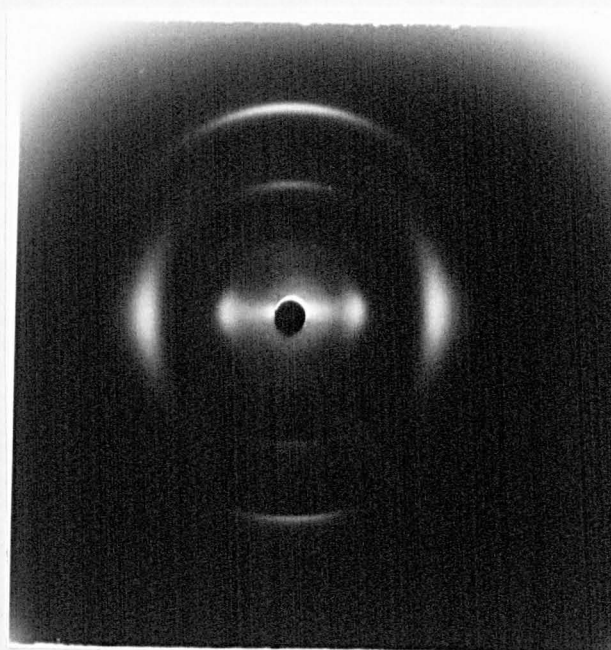

Plate 7.40 (WS)
Coag. methanol
DR. 20% (air)

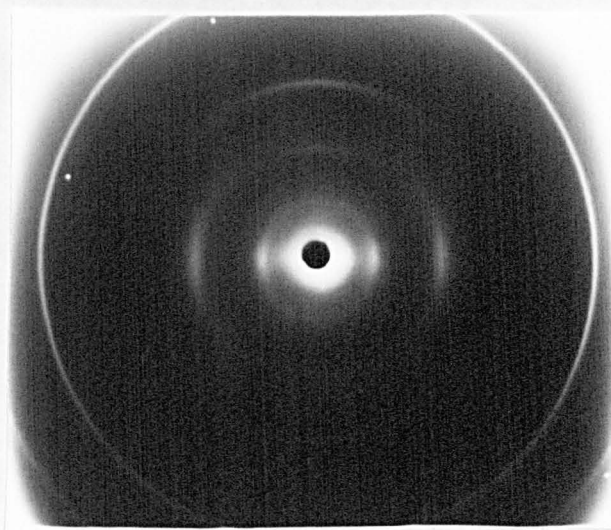

Plate 7.41 (WS)
Coag. water (75°C)
DR. 30% (air)

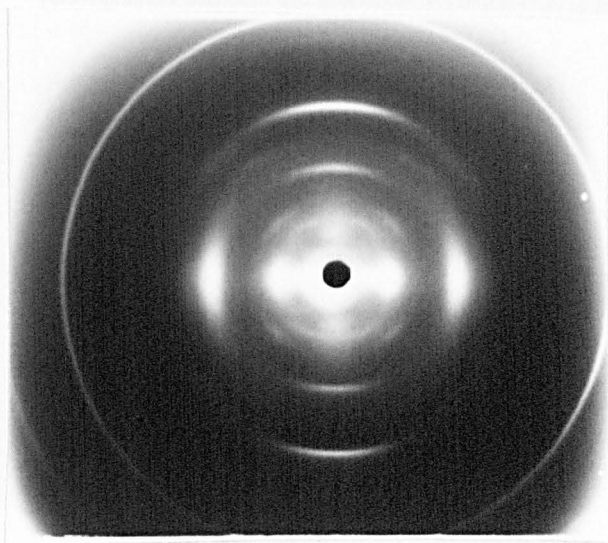

Plate 7.42 (DJWS)

Coag. methanol

DR. 30%

JSR. 0.85

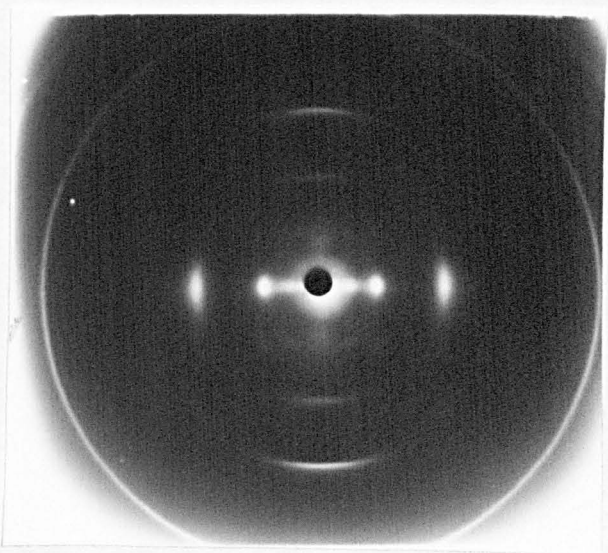

Plate 7.43 (DJWS)

Coag. methanol

DR. 30%

JSR. 4

CHAPTER 8

THE EFFECT OF ADDITION OF
PLASTICIZERS TO THE DOPE

8.1 Introduction

Following the results obtained from the study of the drawing operation (section 7.3.3), it appears that the main important limitations to the production of stronger chitin fibres are the low draw ratios and the rapid decrease in extensibility under tension or during drawing. These problems notwithstanding, fibres with tenacities up to 2.0 g/dtex could be produced. However, the results always indicate that the improved tenacity obtained on drawing is at the expense of a low extensibility. This behaviour is similar in particular to the results obtained from the stretching of secondary cellulose acetate yarns reported by Adetomiwa [200]. Thus, some of the fibres obtained have properties (eg. low breaking toughness) which may strictly limit their uses. This is unlike properties obtained from drawn synthetic fibres such as polyester, acrylic and nylon, which by virtue of their high extensibilities in the undrawn state, still possess sufficient extensibility for normal textile use after drawing.

However, it was not clear at this time how much the limited extensibility (and hence limited opportunity to draw) was inherent in this material and how much it was due to the inability to choose the right conditions for spinning and drawing.

It could be that the lack of extensibility (hence the limited drawing possible) in the fibre is associated with the rapid crystallization of the fibre structure during coagulation [201,202]. If this is so, then it was considered worthwhile to investigate possible ways in which the crystallization could be slowed down. One way considered worthy of investigation was the addition of a 'plasticizer' to the dope. The result of this, it was hoped, would lead to a more effective

drawing operation.

Preliminary tests showed that typical plasticizers of the phthalate type and triphenyl phosphate could be mixed with chitin solutions in DMA/LiCl to give perfectly clear mixtures. It was decided therefore to investigate the possible advantages of using such plasticizers.

8.2 Experimental

8.2.1 Materials

(a) Plasticizers:

Dimethyl phthalate (DMP)
Diethyl phthalate (DEP)
Dibutyl phthalate (DBP)
Diiso-octyl phthalate (DIOP)
Triphenyl phosphate (TPP)

All the plasticizers were obtained from B.D.H. except dibutyl phthalate which was obtained from Aldrich Ltd. They were all first grade general laboratory reagents and were used without further purification. Some physical properties of these plasticizers are shown in Table 8.1.

(b) The chitin used was the same as described in section 7.2.1 except where otherwise indicated.

8.2.2 Preparation of chitin-plasticizer dope

Chitin, 40 g (7%, w/w) was first mixed properly with 45.7 g (8%, w/w) LiCl in a 2 litre plastic jar using a glass rod. Then 16 g (2.8% w/w) of plasticizer (usually between 13.4 ml and 16.2 ml depending

TABLE 8.1: Some physical properties of the plasticizers [203]

Plasticizer	Molecular weight	Density g/cm ³ , (25°C)	Boiling range (°C)	Vapour pressure at 150°C	Viscosity cP, (20°C)	Evaporation rate (g cm ⁻² h ⁻¹)/100°C	Solubility in water %, (20°C)
DMP	194	1.191	282-285	12.50	17.10	1.925×10^{-3}	1.50
DEP	222	1.119	294-296	8.50	10.00 (25°C)	6.170×10^{-4}	0.10
DBP	278	1.043	330-340	1.10	25.00	1.000×10^{-4}	<0.01
DIOP	391	0.986	228-237	<0.05	83.00	-	0.40
TPP	326	1.185	407-410	-	solid	2.800×10^{-7}	0.001 at 34°C

on the density of the plasticizer) was stirred with 470 g (500 ml) of DMA using a magnetic stirrer. On some occasions, distilled water (7.7 ml, 1.4% w/w) was added to DMA instead of the plasticizers.

The DMA-plasticizer solution was then poured into the chitin-LiCl mixture in the jar and the whole system stirred with a stainless steel stirrer at 120 rpm overnight at room temperature.

8.2.3 Preparation of films and fibres

(a) Films

A glass plate specially cut to a size of about 5 cm x 8 cm was fitted with a 2-3 mm thick sellotape layer on both the long sides, so that a gap about 2 cm wide was left along the centre of the glass. This was used for all the films cast. The solution was smeared on the glass surface, doctored out uniformly using a 2.5 x 7.6 cm glass slide and then immersed in a coagulant for 1 hour. At the end of this period, the film was taken out and immersed in methanol for 10 minutes, and then hung from a glass rod to dry in air after a current of air had been blown across the surface of the film for about 5 minutes. The film tended to shrink when drying and this was partially controlled by attaching a clip to each of the two opposite smaller sides of the film. One of the clips was then attached to a glass rod and the other allowed to drop gently under its own weight (~ 6 g), so that the film was held between both clips. The device prevented the lengthwise shrinkage, but not the widthwise. (To prevent shrinkage completely, clips must be used on all the sides of the film.)

(b) Fibre

The fibres were produced by wet spinning using as usual the 80 μm , 20 hole spinneret and, on one occasion, a 50 μm , 40 hole spinneret. For each plasticizer three different coagulants were used (ie. methanol, butanol, and DMA/water, 75/25). The choice of these coagulants was based on the quality of the films cast from them (section 8.3.1). With the hope that this could be a chance of further improving the fibre properties, it was decided to extend the experiment to cover both drawing in air and in a hot water bath. Thus, the fibres were drawn at draw ratios between 4 and 30% for each coagulant where possible. As earlier indicated (section 7.3.3.1, Table 7.9) it appeared that (with DMA/water) an increase in the coagulation bath temperature has a profound effect on both the spinning process and the fibre properties. It was considered necessary to further confirm these observations. Therefore, using the DMA/water, 75/25, coagulating bath, fibres were spun at 25, 55 and 75^oC, using a common draw ratio of 12%.

The procedure for spinning was essentially as described in section 7.2.2. Fibres were passed around the pairs of advancing reels once and drawn in hot water or in air or allowed to relax (undrawn samples) in the hot water bath. In each case samples were allowed to collect on a clean glass plate placed below the second roller of the second advancing reels, collected and placed in a methanol bath for 2 hours. At the end of this period, the methanol was drained off by suction and filaments washed 2-3 more times with fresh methanol before drying in a vacuum oven overnight at room temperature.

Further details of the spinning conditions are listed in Table 8.2.

8.3 Results and discussion

8.3.1 General

Before commencing spinning, films were produced from the dopes, in order that the effects of the plasticizers might be quickly assessed in different coagulants. It was observed that films cast in methanol, DMA/water (75/25) and butanol were transparent and smooth. After washing and drying, the films were tough, flexible and strong. On the other hand, films cast in water baths containing acid (pH 3.4), alkali (pH 10.6) or salts (Na_2SO_4 or ZnCl_2 ; 20-50%, v/v) were opaque, the opacity increasing as the plasticizer molecular weight increased. This was presumed to be due to the poor solubility of the plasticizers in the water baths. Films produced were weak and crumbled easily when dried in the oven. (It was very difficult to dry these films in air except after washing in methanol or acetone.) However, when the films prepared from the dope containing DEP were washed in methanol or acetone as soon as they were removed from the water baths, the opacity cleared, the films shrank rapidly and after drying were strong and flexible. In the light of these results, dopes containing plasticizers were only spun into methanol, butanol and DMA/water, 75/25 (75°C).

In comparison with films prepared from pure chitin dope, there was no great indication of improvement, though it was noticed that films obtained from dopes containing DMP, DEP and TPP appeared to be slightly tougher than those from pure chitin.

TABLE 8.2: Spinning conditions

Fixed conditions

Chitin:	C2-2	(treated as described in section 7.2.1 starting with the caustic soda treatment. Dope spun on the 7th day except where otherwise stated)
Pump speed:	3 rpm	
Pump capacity:	1 cc/rev	
Spinneret size:	80 μm , 20 hole	except where otherwise indicated
Linear rate of extrusion:	29.8 m/min	
First advancing reel speed:	23.3 m/min	
Jet stretch ratio:	0.78	
Nitrogen pressure:	15-20 lb/in ²	
Dope concentration:	7% (w/w) chitin; 8% (w/w) LiCl	
Plasticizer concentration:	2.8%, w/w	except where otherwise indicated
Coagulants:	DMA/water, 75/25, v/v Methanol Butanol Water	
Dope temperature:	25 ^o C	
Coagulation bath length:	120 cm	

Variable conditions

DMA/water bath temperature:	25 ^o C-75 ^o C
Second advancing reel speed:	24.3-30.3 m/min

8.3.2 Effect of addition of plasticizers to the dope

8.3.2.1 Effect on dope viscosity

Table 8.3 shows the effect of additions of 2.8% of different plasticizers to the dope on dope viscosity. The viscosities of the dopes were measured at 25°C, 3.6 sec⁻¹ and also at 60°C for some selected dopes. To start with, all the dopes obtained had a similar appearance to that of the pure chitin dope. However, their dope viscosities were higher than the latter, except for the dope containing DEP, which surprisingly had a lower viscosity at both 25 and 60°C. An examination of the results indicates that the viscosity data appear to follow a pattern similar to the viscosity data shown in Table 8.1 for the pure plasticizers. That is, excepting the results obtained for DEP, it appears that the dope viscosity is influenced by the molecular weight of the plasticizer. For each case examined, an increase in dope temperature to 60°C resulted in a 4-5 fold drop in the viscosity. The viscosity of the dope without plasticizer was reduced by ~4 fold. This indicated that it would be possible to spin at dope temperatures above room temperature. There is an obvious contrast in the behaviour of these dopes with those containing water, in which rapid gelation was observed on heating (section 8.3.3). It may be that the effectiveness of some of these plasticizers would increase with increase in temperature [203,204].

Significant differences between the plasticizers were noted. With DBP and DIOP, additions to the dope of ~2.8% (w/w) led to a faint opacity indicating perhaps the onset of precipitation. Additions of DMP and DEP by contrast were made as high as 5.3% (w/w) with still no

TABLE 8.3: Effect of addition of plasticizer on dope viscosity

Plasticizer*	Dope viscosity (3.6 sec^{-1}) Pas	
	25°C	60°C
None	62	15
DMP	73	14
DEP	56	11
DBP	66(27°C)	-
DIOP	80	19
TPP	69	-

* Plasticizer was 2.8% (w/w)

Dope concentration: 7% (w/w) chitin; 8% (w/w) LiCl

evidence of phase separation. No attempt was made to use concentrations of the latter two plasticizers above 5.3%.

8.3.2.2 Effect on fibre properties

Tables 8.4-8.8 show separately the effect of each plasticizer on the mechanical properties of the fibres spun into DMA/water, 75/25 (75°C) or methanol or butanol at various draw ratios. However, while the tables give an immediate comparison of the effects of spinning into different coagulants for each plasticizer, a comparison of the effects of the plasticizers with each other is not shown. Therefore, extracts from Tables 8.4-8.8 are shown in Tables 8.9 and 8.10 which compare together the effects of the plasticizers. Table 8.11 gives a comparison of the properties of the fibres obtained from three selected plasticizers (DMP, DEP and TPP) with those of pure chitin fibres. Figures 8.1-8.3 show similar comparisons of the effect of each plasticizer on the fibre tenacity with those of pure chitin at various draw ratios.

Examination of Tables 8.9 and 8.10 shows (based on the tenacity values) that the plasticizers can be broadly classified into two groups. The first group made up of DMP, DEP and TPP, always appeared to give fibres with higher tenacity values than the second group of DBP and DIOP, independent of both coagulation and drawing conditions. On comparing each group separately with fibres prepared with no plasticizer, some interesting features were observed. In most cases, the fibres prepared from the dopes containing any of the plasticizers in the first group and spun into methanol or DMA/water, 75/25 (75°C) were observed to have tenacity values higher than those of pure chitin fibres,

TABLE 8.4: Effect of DMP in the dope on fibre properties

Sample No.	Coagulant	Draw ratio (%)	Fibre diameter (μm)	Fibre count (dtex)	Tenacity T (g/dtex)	Extensibility E (%)	Tensile factor $TE^{\frac{1}{2}}$
8-1	DMA/water	4	28.0	8.5	1.47	36	8.82
8-2	75/25	12	24.0	6.0	1.82	17.0	7.50
8-3	75°C	20	22.6	5.5	2.02	11.4	6.82
8-4			(23.6)	(6.0)	(1.65)	(22.6)	(7.84)
8-5		30	(22.3)	(5.4)	(2.07)	(11.7)	(7.08)
8-6	Methanol	4	23.0	5.8	1.86	18.0	7.90
8-7	21°C		(26.0)	(7.4)	(1.43)	(32.8)	(8.20)
8-8		12	22.0	5.2	2.04	10.8	6.70
8-9		15	(21.8)	(5.0)	(1.86)	(13.0)	(6.71)
8-10		20	(21.0)	(4.8)	(2.13)	(9.5)	(6.57)
8-11	Butanol	4	(26.7)	(7.7)	(1.19)	(53.6)	(8.70)
8-12	23°C	15	(23.5)	(6.0)	(1.55)	(25.3)	(7.80)
8-13		20	(22.0)	(5.0)	(1.63)	(19.2)	(7.15)

() drawn in air

TABLE 8.5: Effect of DEP in the dope on fibre properties

Sample No.	Coagulant	Draw ratio (%)	Fibre diameter (μm)	Fibre count (dtex)	Tenacity T (g/dtex)	Extensibility E (%)	Tensile factor $TE^{\frac{1}{2}}$	
8-14	DMA/water, 75/25 75°C	4	28.0	8.0	1.48	35.4	8.80	
8-15		12	24.5	6.5	1.90	16.0	7.60	
8-16		20	23.0	5.5	2.26	11.2	7.56	
8-17				(25.5)	(7.0)	(1.56)	(25.5)	(7.88)
8-18			30	(23.7)	(6.0)	(2.21)	(14.0)	(8.00)
8-19	Methanol 21°C	4	23.0	5.5	1.80	18.0	7.64	
8-20			(24.0)	(6.3)	(1.64)	(31.8)	(9.25)	
8-21		12	22.0	5.0	1.96	10.5	6.35	
8-22		15	(21.5)	(5.0)	(1.90)	12.0	(6.60)	
8-23		20	(20.0)	(4.5)	(2.10)	(8.2)	(6.00)	
8-24	Butanol 23°C	4	(26.6)	(7.7)	(1.30)	(60.0)	(10.00)	
8-25		15	(23.0)	(6.0)	(1.40)	(25.0)	(7.00)	
8-26		20	(21.6)	(5.0)	(1.85)	(20.0)	(8.30)	

() drawn in air

TABLE 8.6: Effect of DBP in the dope on fibre properties

Sample No.	Coagulant	Draw ratio (%)	Fibre diameter (μm)	Fibre count (dtex)	Tenacity T (g/dtex)	Extensibility E (%)	Tensile Factor $TE^{\frac{1}{2}}$	
8-27	DMA/water, 75/25 75°C	4	28.0	8.5	1.20	38.0	7.40	
8-28		12	23.6	6.2	1.54	17.0	6.35	
8-29		20	22.0	5.3	1.89	11.1	6.30	
8-30				(23.0)	(5.8)	(1.48)	(19.7)	(6.57)
8-31			30	(22.0)	(5.0)	(1.83)	(9.9)	(5.76)
8-32	Methanol 21°C	4	23.8	6.2	1.46	22.5	6.93	
8-33			(25.0)	(6.8)	(1.30)	(36.4)	(7.84)	
8-34		12	frequent breakage in the hot water draw bath					
8-35		15	(22.3)	(5.5)	(1.66)	(14.0)	(6.21)	
8-36		20	(21.6)	(5.0)	(1.78)	(10.0)	(5.63)	
8-37	Butanol 23°C	4	(28.0)	(8.5)	(0.83)	(66.0)	(6.74)	
8-38		15	(24.0)	(6.3)	(1.30)	(33.3)	(7.50)	
8-39		20	(22.5)	(5.5)	(1.50)	(22.8)	(7.16)	

TABLE 8.7: Effect of addition of DIOP to the dope on fibre properties

Sample No.	Coagulant	Draw ratio (%)	Fibre diameter (μm)	Fibre count (dtex)	Tenacity T (g/dtex)	Extensibility E (%)	Tensile Factor $\text{TE}^{\frac{1}{2}}$	
8-40	DMA/water, 75/25 75°C	4	28.5	8.6	1.25	38.4	7.74	
8-41		12	23.0	5.8	1.58	19.5	7.00	
8-42		15	(26.2)	(7.5)	(0.96)	(29.3)	(5.20)	
8-43		20	21.0	4.8	1.93	11.6	6.58	
8-44		(24.6)	(6.6)	(1.36)	(27.1)	(7.08)		
8-45	30	frequent fibre breakage						
8-46	Methanol 21°C	4	22.6	5.5	1.60	23.0	7.67	
8-47			(25.3)	(6.6)	(1.37)	(33.8)	(7.96)	
8-48		12	frequent fibre breakage in the hot water draw bath					
8-49		15	(23.3)	(5.9)	(1.60)	(19.3)	7.03	
8-50		20	(20.7)	(4.7)	(1.80)	(11.2)	(6.03)	
8-51	Butanol 23°C	4	(27.0)	(8.0)	(0.93)	(64.8)	(7.50)	
8-52		15	(24.0)	(6.3)	(1.24)	(29.2)	(6.70)	
8-53		20	(22.3)	(5.4)	(1.46)	(21.0)	(6.70)	

() drawn in air

TABLE 8.8: Effect of TPP in the dope on the fibre properties

Sample No.	Coagulant	Draw ratio (%)	Fibre diameter (μm)	Fibre count (dtex)	Tenacity T (g/dtex)	Extensibility E (%)	Tensile factor $TE^{\frac{1}{2}}$
8-54	DMA/water, 75/25 75°C	4	28.0	8.5	1.40	38.0	8.63
8-55		12	23.0	5.7	1.77	18.1	7.53
8-56		20	22.3	5.0	1.91	14.0	7.15
8-57		(23.9)	(6.2)	(1.65)	(22.1)	(7.80)	
8-58		30	(21.7)	(5.0)	(2.26)	(11.0)	(7.50)
8-59 ⁺		30	(13.8)	(2.0)	(2.32)	(14.2)	(8.74)
8-60	Methanol 21°C	4	23.8	6.2	1.65	19.4	7.27
8-61			25.0	(6.8)	(1.48)	(34.2)	(8.66)
8-62		15	(22.3)	(5.4)	(1.88)	(12.7)	(6.70)
8-63		20	(21.9)	(5.0)	(1.90)	(8.3)	(5.50)
8-64	Butanol 23°C	4	(27.8)	(8.4)	(1.14)	(61.1)	(8.90)
8-65		15	(25.0)	(6.8)	(1.30)	(27.0)	(6.80)
8-66		20	(24.5)	(6.0)	(1.53)	(20.0)	(6.80)

() drawn in air

+ 50 μm 40 hole spinneret

TABLE 8.9: Effect of addition of plasticizers to the dope on the fibre properties (data from Tables 8.4-8.8)

Plasticizer	DMP	DEP	DBP	DIOP	TPP
<u>A</u>					
Tenacity (g/dtex)	1.82	1.90	1.54	1.58	1.77
Extensibility (%)	17.0	16.0	17.0	19.5	18.1
Tensile factor	7.50	7.60	6.35	7.00	7.52
<u>B</u>					
Tenacity (g/dtex)	2.02	2.26	1.89	1.93	1.91
Extensibility (%)	11.4	11.2	11.1	11.6	14.0
Tensile factor	6.82	7.56	6.30	6.58	7.15
<u>C</u>					
Tenacity (g/dtex)	1.86	1.80	1.46	1.60	1.65
Extensibility (%)	18.0	18.0	22.5	23.0	19.4
Tensile factor	7.90	7.64	6.93	7.67	7.27
<u>D</u>					
Tenacity (g/dtex)	2.04	1.96	Not possible to spin		
Extensibility (%)	10.8	10.5	continuously due to		
Tensile factor	6.70	6.35	frequent fibre breakage		
			in the draw bath.		

All the samples were drawn in a hot water bath

A	DMA/water, 75/25 (75°C)	DR	12%
B	"	DR	20%
C	Methanol (21°C)	DR	4%
D	"	DR	12%

TABLE 8.10: Effect of addition of plasticizers to the dope on the fibre properties (data from Tables 8.4-8.8)

Plasticizer	DMP	DEP	DBP	DIOP	TPP
<u>A</u>					
Tenacity (g/dtex)	2.07	2.21	1.83	frequent	2.26
Extensibility (%)	11.7	14.0	9.9	breakage	11.0
Tensile factor	7.08	8.0	5.76		7.50
<u>B</u>					
Tenacity (g/dtex)	1.43	1.64	1.30	1.37	1.48
Extensibility (%)	32.8	31.8	36.4	33.8	34.2
Tensile factor	8.20	9.25	7.84	7.96	8.66
<u>C</u>					
Tenacity (g/dtex)	2.13	2.10	1.78	1.80	1.90
Extensibility (%)	9.5	8.2	10.0	11.2	8.3
Tensile factor	6.57	6.00	5.63	6.02	5.5
<u>D</u>					
Tenacity (g/dtex)	1.19	1.30	0.83	0.93	1.14
Extensibility (%)	53.6	60.0	66.0	64.8	61.1
Tensile factor	8.7	10.0	6.74	7.5	8.90
<u>E</u>					
Tenacity (g/dtex)	1.63	1.85	1.50	1.46	1.53
Extensibility (%)	19.2	20.0	22.8	21.0	20.0
Tensile factor	7.15	8.3	7.16	6.70	6.8

All the samples were drawn in air

A	DMA/water, 75/25 (75°C)	DR	30%
B	Methanol (21°C)	DR	4%
C	Methanol (21°C)	DR	20%
D	Butanol (23°C)	DR	4%
E	Butanol (23°C)	DR	20%

TABLE 8.11: Comparison of the fibre properties spun from dopes with and without plasticizers

Coagulant	Draw ratio (%)	With plasticizer									Without plasticizer		
		Tenacity, T (g/dtex)			Extensibility, E (%)			Tensile factor, $TE^{\frac{1}{2}}$			Tenacity (g/dtex)	Extensibility (%)	Tensile factor $TE^{\frac{1}{2}}$
		DMP	DEP	TPP	DMP	DEP	TPP	DMP	DEP	TPP			
Methanol	4	1.86	1.80	1.65	18.0	18.0	19.4	7.90	7.64	7.27	1.51	21.8	7.05
		(1.43)	(1.64)	(1.48)	(32.8)	(31.8)	(34.2)	(8.20)	(9.25)	(8.66)	(1.43)	(31.2)	(8.00)
	12	2.04	1.96	-	10.8	10.5	-	6.70	6.35	-	1.91	11.8	6.56
		(2.13)	(2.10)	(1.90)	(9.5)	(8.2)	(8.3)	(6.57)	(6.00)	(5.50)	(1.93)	(9.4)	(5.90)
DMA/water 75/25 (75°)	12	1.82	1.90	1.77	17.0	16.0	18.1	7.50	7.60	7.53	1.63	20.0	7.16
		(1.65)	(1.56)	(1.65)	(22.6)	(25.5)	(22.1)	(7.84)	(7.88)	(7.80)	(1.51)	(25.0)	(7.55)
	20	2.02	2.26	1.91	11.4	11.2	14.0	6.82	7.56	8.68	2.14	13.5	7.86
		(1.07)	(2.21)	(2.27)	(11.7)	(14.0)	(15.2)	(7.08)	(8.00)	(8.85)	(2.00)	(17.3)	(8.32)
Butanol	4	(1.19)	(1.30)	(1.14)	(53.6)	(60.0)	(61.1)	(8.70)	(10.0)	(8.90)	(0.93)	(55.0)	(6.90)
	20	(1.63)	(1.85)	(1.53)	(19.2)	(20.0)	(20.0)	(7.15)	(8.30)	(6.80)	(1.40)	(15.6)	(5.54)

() drawn in air

FIG. 8.1: Comparison of the effect of drawing on tenacity of plasticized chitin fibres with those of pure chitin (PCF)

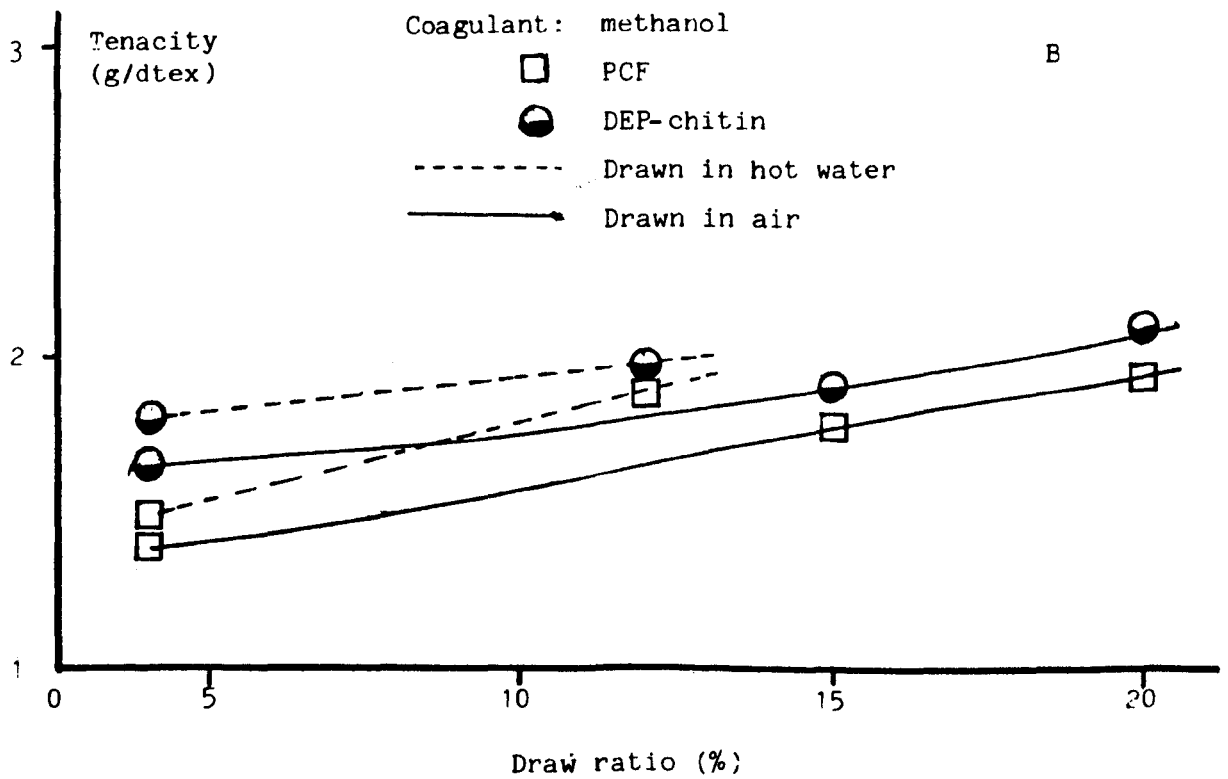
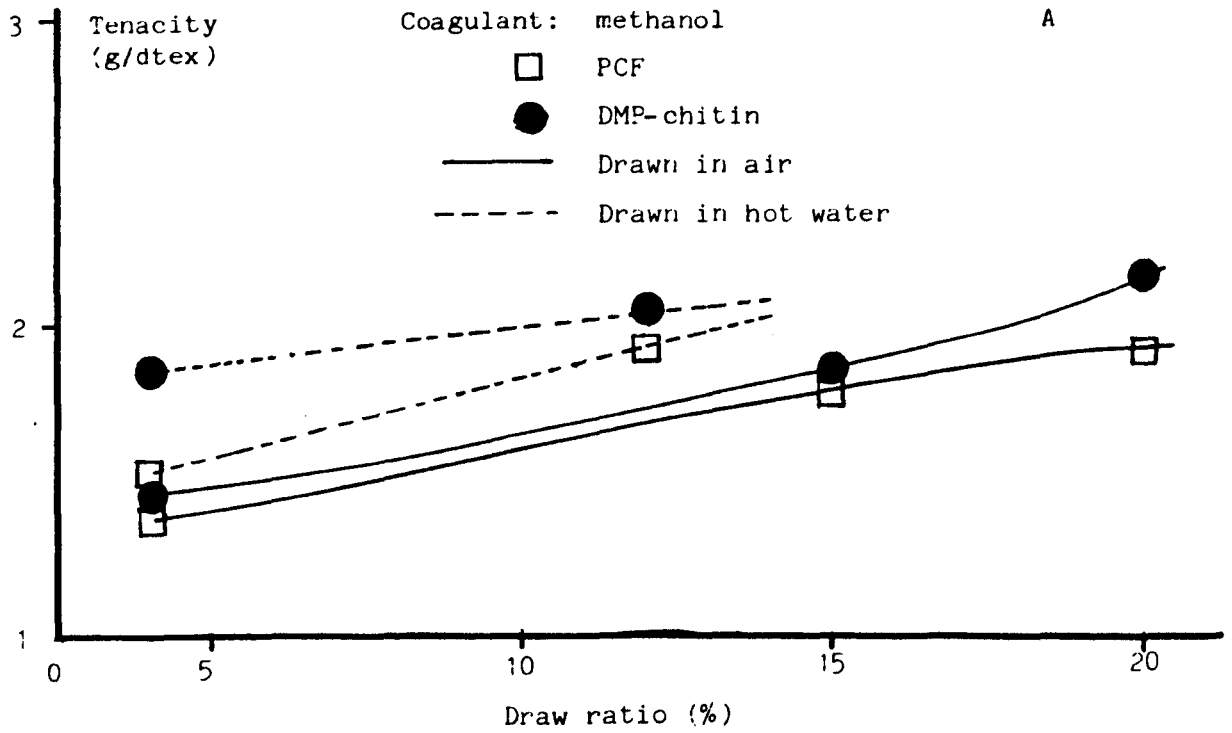

FIG. 8.2: Comparison of the effect of drawing on tenacity of plasticized chitin fibres with those of pure chitin (PCF)

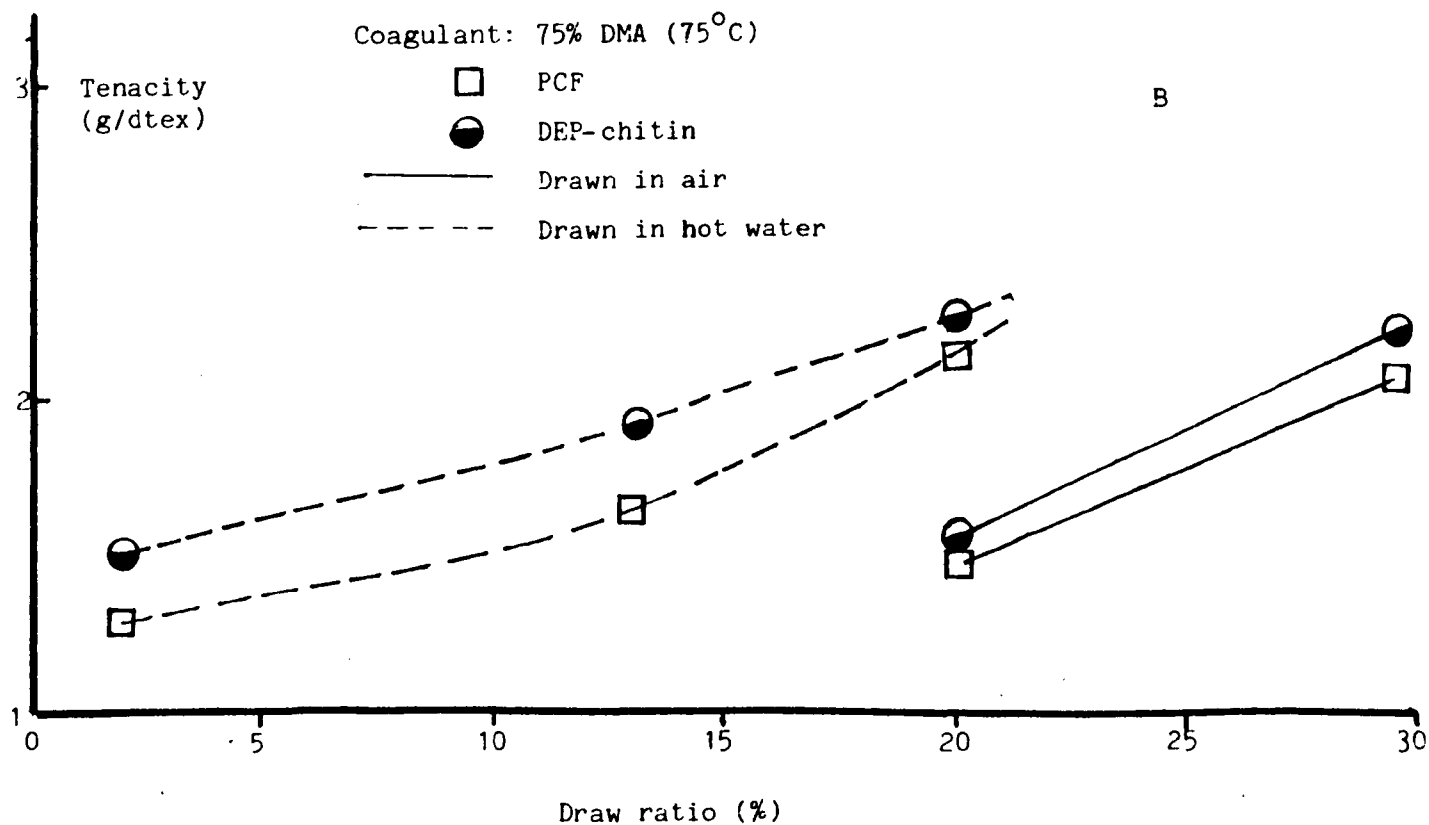
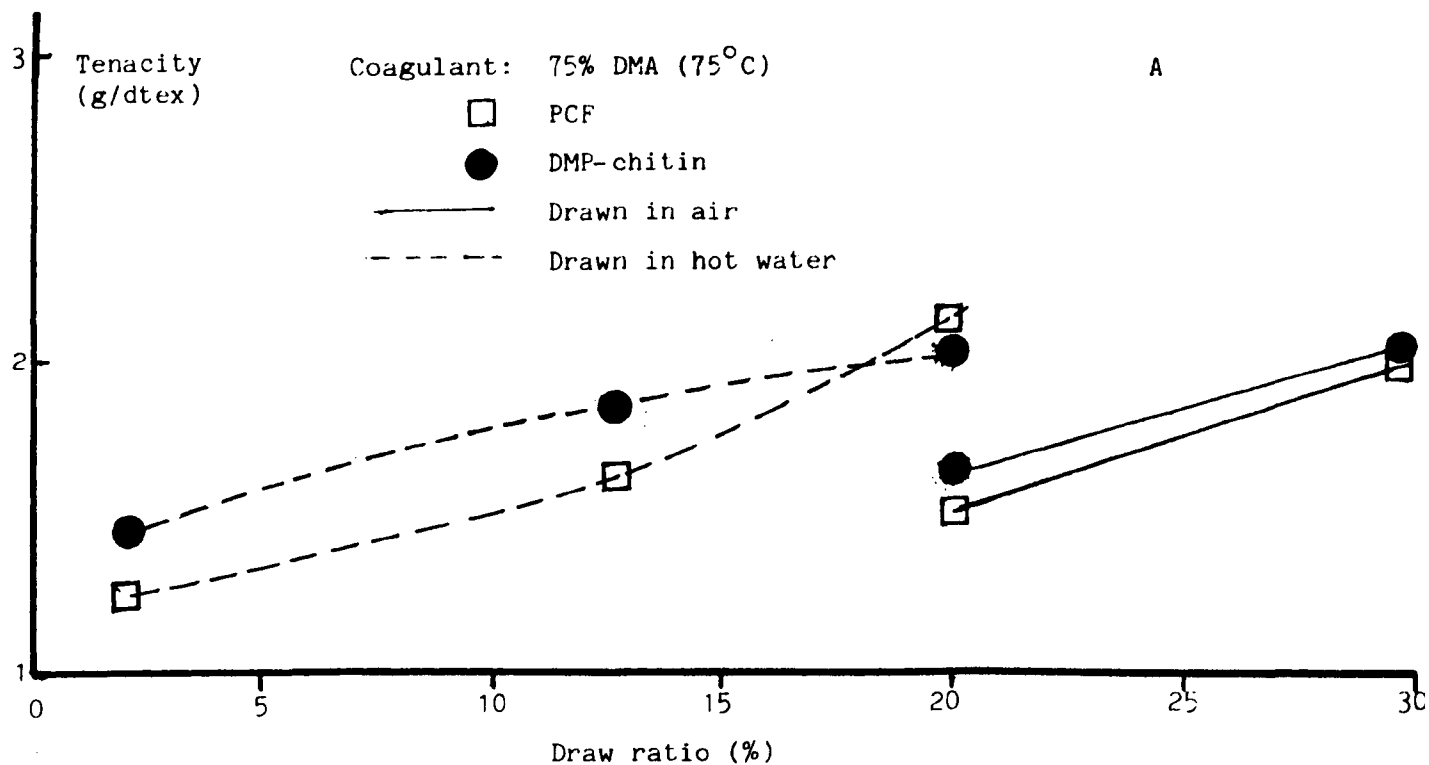
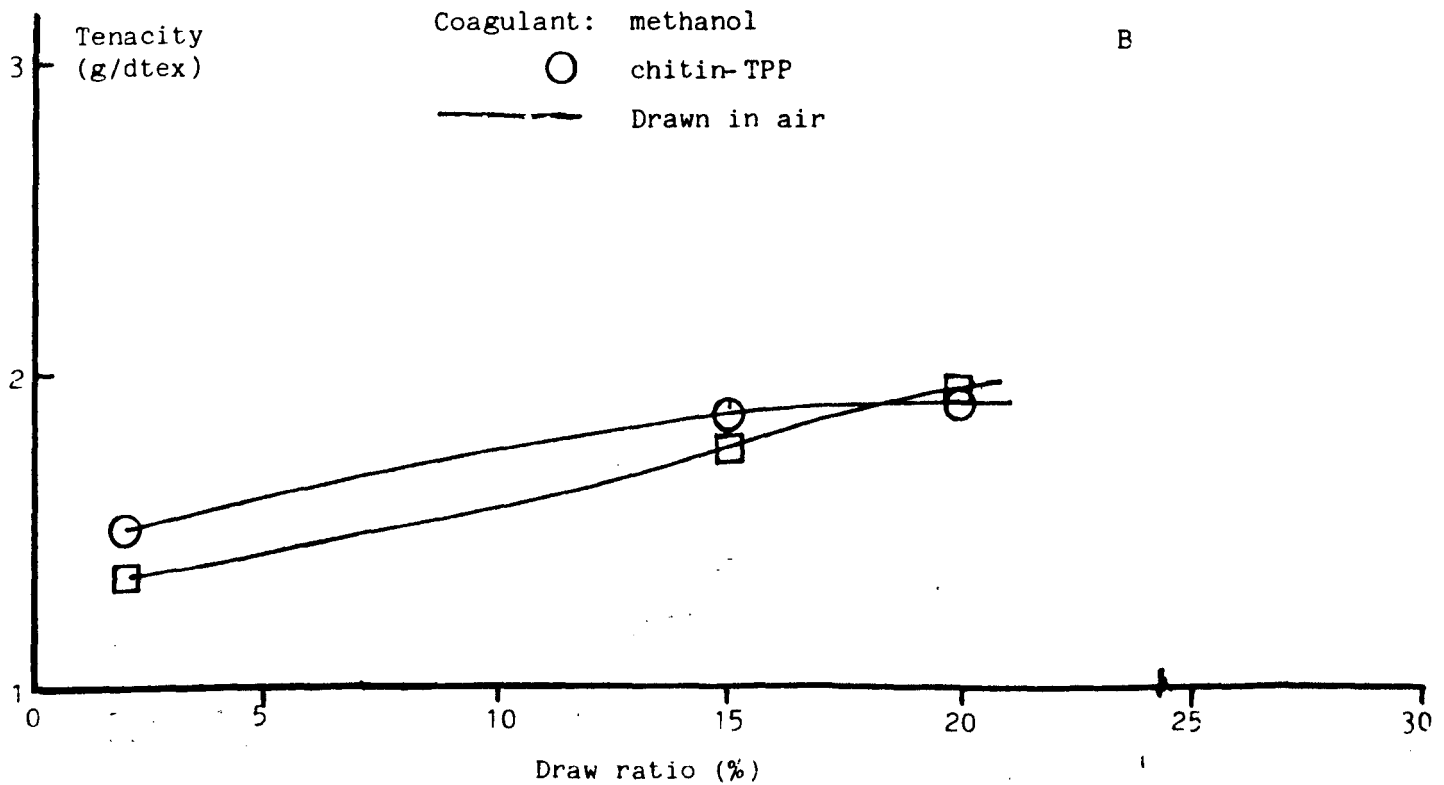
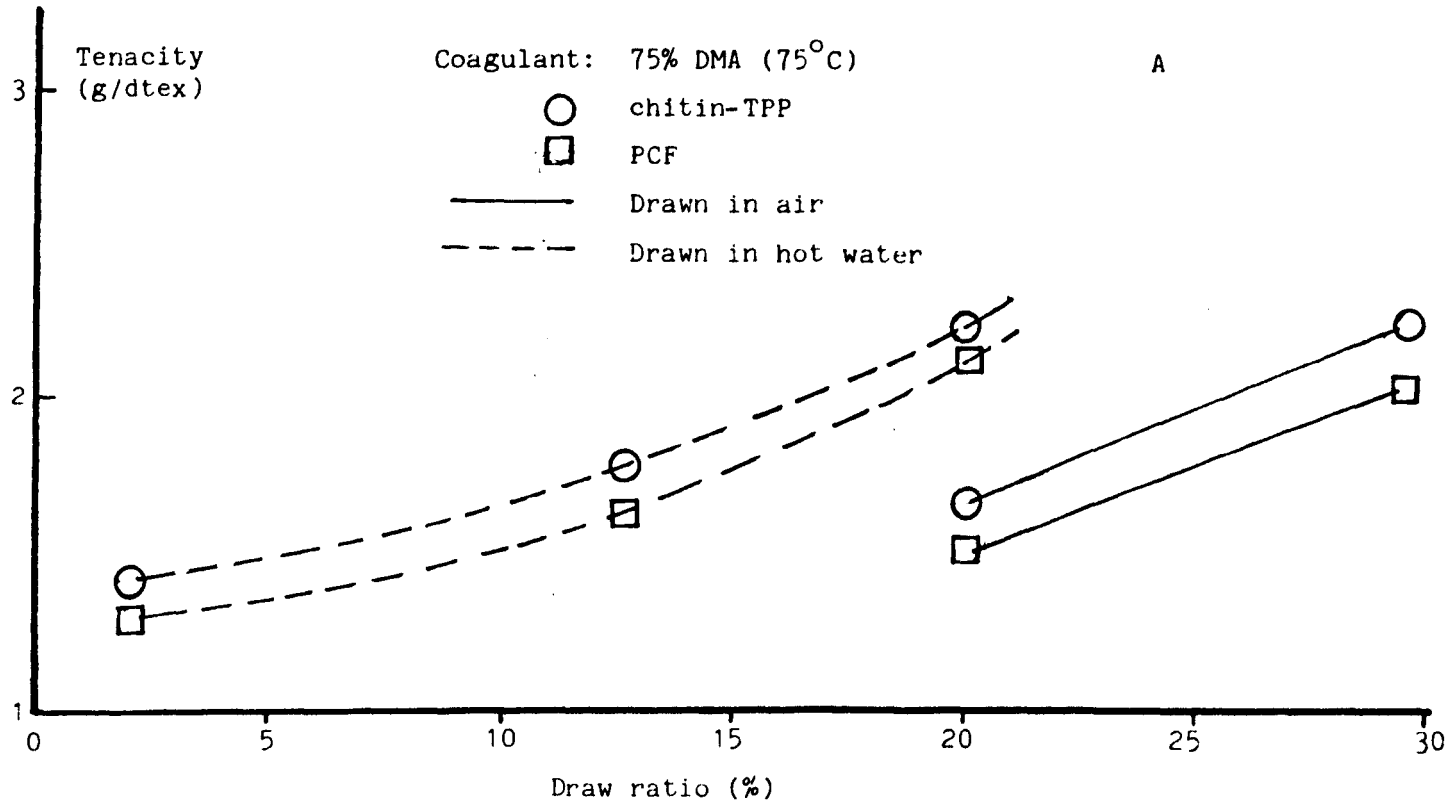

FIG. 8.3: Comparison of the effect of drawing on tenacity of TPP-chitin fibres with those of pure chitin (PCF)



independent of draw ratios or whether the fibres were drawn in air or in a hot water bath (Table 8.11, Figs. 8.1-8.3). It was noticeable, however, that pure chitin fibres were themselves slightly better than those containing any of the two plasticizers, DBP and DIOP.

On further examination of Figs. 8.1-8.3, it can be seen that the effect of DMP, DEP and TPP on fibre tenacity values appears to be more noticeable with those fibres drawn in a hot water bath. For these fibres, the tenacity values obtained at low draw ratio (<12%) were substantially higher than those of pure chitin fibres. In each case, it was found that as the draw ratio increased, the difference in the tenacity values between the plasticized fibre and those of pure chitin decreased. Indeed, a critical study of the shapes of most of the curves shown for these fibres shows that if the data is extrapolated to higher draw ratios, the tenacity values for pure chitin fibres could eventually become higher than those made using the plasticizers. This indicates that one of the principal advantages of using such plasticizers was the relatively high tenacity values obtained at low draw ratios. This may be important since in most spinning conditions, fibres spun more continuously at low draw ratios. The problem was that most fibres spun at such draw ratios previously had low tenacity values.

Another interesting feature of some of the plasticizers was the improvement in fibre spinnability obtained. This was quite noticeable at all the draw ratios examined, although maximum draw ratios attainable were not determined. Such plasticizers as DMP and DEP were the most favoured in this respect, while it seemed that spinnability even deteriorated with DBP and DIOP. Thus, it was not

possible to draw the fibres containing DBP or DIOP that were spun into methanol by 12% in a hot water bath. Similarly, DIOP containing fibres could not be drawn by 30% in air after being spun into DMA/water, 75/25 at 75°C. These results suggest that the choice of plasticizers is important not only in affecting the tenacity of these fibres produced but also in the continuity of the spinning process. From all indications, it appears that the more compatible the plasticizer was, the better the fibre tenacity and spinnability. However, the use of plasticizers did not result in significant changes in the general effects of the spinning conditions on fibre spinning and properties as earlier observed; one exception was that the coagulating filaments were generally observed to become opaque (and slightly weaker) when drawn in water, the weakness being more pronounced with the fibres spun from dopes containing DBP or DIOP. Thus, drawing in air was much more continuous than in a hot water bath, but as usual, was less effective at low draw ratios (4-10%). The effect of drawing on fibre properties is virtually the same, that is, an increase in draw ratio increased the fibre tenacity and decreased the extensibility. Interestingly, there was very little variation in the values of extensibility from one plasticizer to another at any particular draw ratio using any of the coagulants, though the less compatible plasticizers (DBP and DIOP) appeared to have slightly higher extensibilities on some occasions. Furthermore, apart from the slightly higher values of extensibility noticed with pure chitin fibres at low draw ratios when compared with those of the plasticized fibres, differences in extensibilities were inconsistent and usually very small. Similar observations were made with the tensile factors. Finally, as was previously observed with fibres spun into butanol, it was only

possible to draw the fibres in air. The fibres were usually very weak in the hot water draw bath. Such fibres spun into butanol were also dull and soft. Lustrous fibres were only obtained when DMA/water, 75/25 or methanol was used as coagulant. Conditions for obtaining such fibres remained the same as was earlier described (sections 7.3.3.1 and 7.3.3.2).

Although the improvement in fibre tenacity obtained with the addition of plasticizer was small, it was tempting enough for a re-examination of the effect of coagulation bath temperature on fibres spun from dopes containing plasticizer.

Table 8.12 shows the results obtained for each of the plasticizers, using DMA/water, 75/25, at three different bath temperatures (25, 55 and 75°C). For comparison, the results previously obtained for pure chitin dope at these temperatures (extract from Table 7.9, section 7.3.3.1) are also included. It is clearly apparent from these results that an increase in coagulation bath temperature does indeed improve the mechanical properties of the fibres. Although such improvement in extensibility and tensile factor was earlier noticed with pure chitin dope, it appears that the improvement now obtained in tenacity with each plasticizer (except DBP) is higher than was previously observed. For dopes plasticized with DMP, DEP and TPP, the increase in tenacity at bath temperatures between 50 and 80°C over the rest was very substantial, indicating once again the superiority of these three plasticizers. However, for TPP, the choice of coagulation bath temperature appears to be even more important, as it was not possible to draw the fibres by 12% in a hot water draw bath when the coagulation bath temperature was at 25°C. A similar problem

TABLE 8.12: Effect of addition of plasticizers to the dope on the fibres spun into a DMA/water bath at different temperatures

Sample No.	Plasticizer	Bath temp. (°C)	Fibre diameter (µm)	Fibre count (dtex)	Tenacity T (g/dtex)	Extensibility E (%)	Tensile factor $TE^{\frac{1}{2}}$	
7-42	None	25	24.6	6.8	1.58	10.6	5.14	
7-45		55	26.8	7.5	1.60	17.0	6.60	
7-47		75	26.8	7.5	1.63	20.0	7.29	
8-67	DMP	25	24.0	6.0	1.64	9.0	4.92	
8-68		55	"	"	1.69	15.0	6.55	
8-2		75	"	"	1.82	17.0	7.50	
8-69	DEP	25	23.4	6.0	1.78	10.3	5.71	
8-70		55	23.8	6.2	2.00	15.7	8.00	
8-15		75	24.5	6.5	1.90	16.0	7.60	
8-71	DBP	25	frequent breakage in the hot water draw bath					
8-72		55	23.6	6.2	1.53	16.6	6.23	
8-28		75	"	"	1.54	17.0	6.35	
8-73	DIOP	25	frequent breakage in the hot water draw bath					
8-74		55	23.7	6.2	1.50	18.1	6.38	
8-41		75	23.0	5.8	1.58	19.5	7.82	
8-75	TPP	25	frequent breakage in the hot water draw bath					
8-76		55	24.0	6.0	1.70	18.0	7.21	
8-55		75	23.0	5.7	1.77	18.1	7.53	

Spinning conditions: Hot water draw bath 80°C
Draw ratio 12%

was encountered with DBP and DIOP.

8.3.2.3 Ultraviolet (UV) absorption spectra of plasticized chitin fibre

Having investigated the effects of various plasticizers on spinning and fibre properties, the question arose as to the retention of these plasticizers in the fibres. It was therefore decided to examine the ultraviolet spectra of some solvent extracts from selected DEP samples using the UV spectrophotometer model 402 (Perkin-Elmer).

To start with, a known volume of the plasticizer was first taken in 100 ml of 95% ethanol and the UV spectrum of the solution measured between wavelengths of 230 and 310 nm, as the maximum absorption for phthalates is at 275 nm. After several trials, it was found that about 6.7×10^{-3} ml of the plasticizer in 100 ml of ethanol (conc. 7.5×10^{-2} g/l) gave a satisfactory detectable absorbance. After this, about 0.07-0.08 g DEP fibre was taken and extracted for about 24 hours in 10 ml ethanol at room temperature with gentle stirring. The UV spectrum was then measured. A sample of a pure chitin fibre was also extracted in ethanol for 24 hours and its UV spectrum measured. Furthermore, about 0.083 g DEP fibre was taken in 18 ml of ethanol and refluxed at 70-75°C for 1 hour with very gentle stirring and its UV spectrum also recorded. In each case, ethanol was used as the reference solvent.

Figure 8.4 shows the spectra obtained in which the absorbance is plotted against the wavelength. As expected, DEP/ethanol exhibited a strong band in the region 230-250 nm and a single absorption maximum at 275 nm (curve A). It can be seen that the two DEP samples and the pure chitin sample (curves C, D and B respectively) extracted in ethanol

FIG. 8.4: Comparison of UV spectrum of DEP and those of pure and DEP-chitin fibres

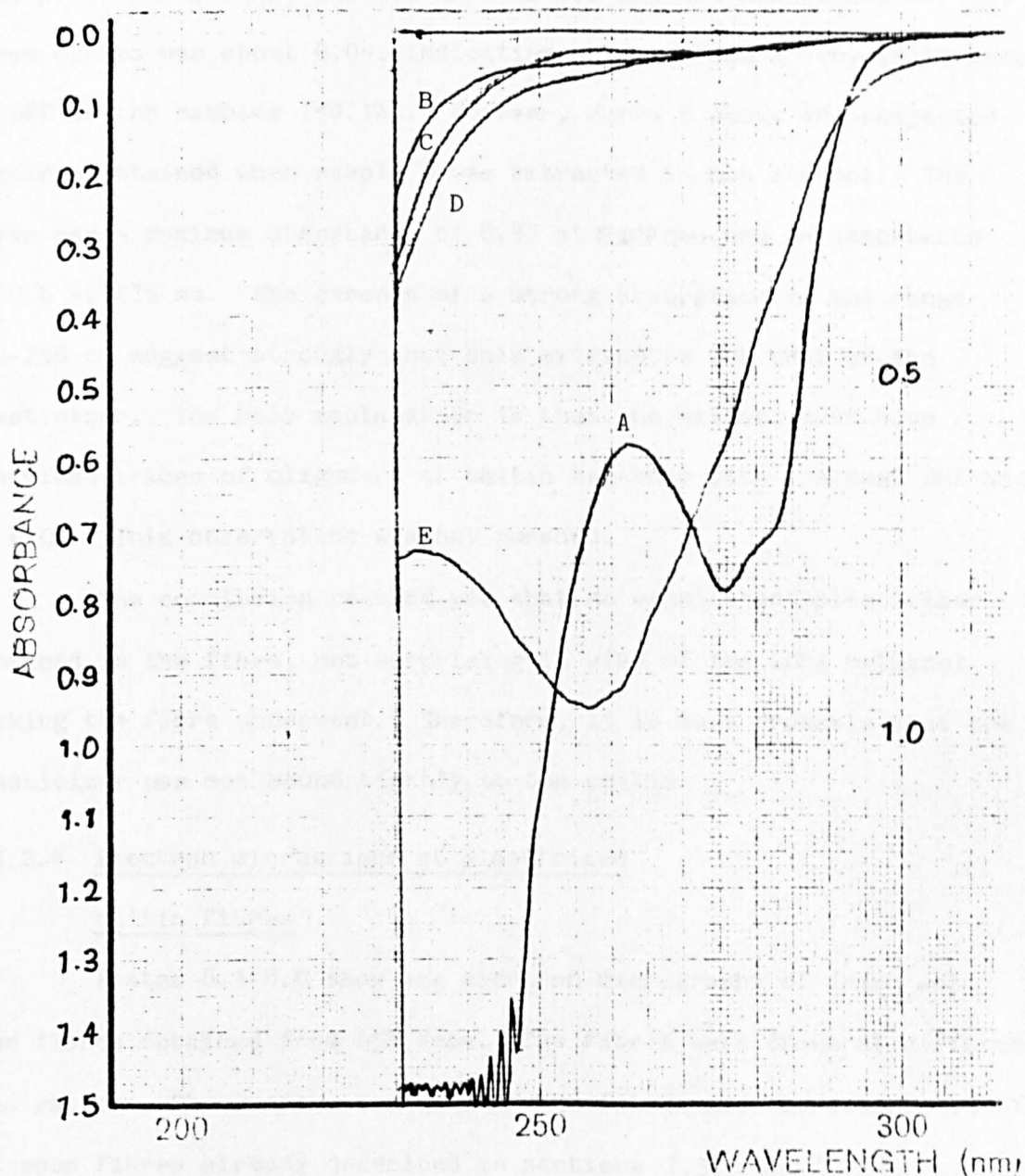

- | | | |
|---|-------------------|-------------------|
| A | DEP/EtOH | (conc. 0.075 g/l) |
| B | Pure chitin fibre | (conc. 7.0 g/l) |
| C | DEP-chitin fibre | (conc. 6.7 g/l) |
| D | " " | (conc. 8.0 g/l) |
| E | " " | (conc. 8.3 g/l) |

Samples B-D were soaked in 95% EtOH at room temperature for 24 h
 Sample E was extracted in 95% EtOH at 70-75°C for 1 h

for 24 hours at room temperature showed only very slight evidence of absorption between 230 and 250 nm. At 275 nm, the absorbance for the three curves was about 0.04, indicating no more than a very small amount of DEP in the samples (<0.1%). However, curve E shows an unexpected spectrum obtained when sample D was extracted in hot ethanol. The curve had a maximum absorbance of 0.95 at ~~257~~ nm, and an absorbance of 0.6 at 275 nm. The absence of a strong absorption in the range 230-250 nm suggest strongly that this extract is not that of the plasticizer. The only explanation is that the extract must have contained traces of oligomers of chitin together with residual DMA and/or LiCl. This observation was not pursued.

The conclusion reached was that no significant plasticizer remained in the fibre, not surprising in view of the long methanol soaking the fibre underwent. Therefore, it is most probable that the plasticizer was not bound tightly to the chitin.

8.3.2.4 Electron micrographs of plasticized chitin fibres

Plates 8.1-8.6 show the electron micrographs of drawn wet spun fibres obtained from DEP dope. The fibres were drawn at different draw ratios. The surface features of the fibres are characteristic of wet spun fibres already described in sections 7.3.1 and 7.3.4. For the undrawn fibres, it was observed under the microscope that the surfaces were as usual very rough and furrowed. As expected surface smoothness was obtained only with fibres spun into DMA/water, 75/25 or methanol baths, and drawn by more than 15% in air or in a hot water bath by over 4%. Such fibres were also the ones that possessed lustre. Fibres spun into butanol and drawn in air like those described in

PLATES 8.1-8.6: ELECTRON MICROGRAPHS OF DRAWN WET
SPUN CHITIN FIBRES SPUN FROM DOPE
CONTAINING DEP

- Plates 8.1 and 8.2 Surface texture and cross-section of fibres drawn by 4% in air or hot water bath (coagulant: 75% DMA, 75°C)
- Plates 8.3 and 8.4 Surface texture of fibres drawn by 20% in air or hot water bath
- Plates 8.5 and 8.6 Surface texture and cross-section of fibres spun into butanol and drawn in air by 20%

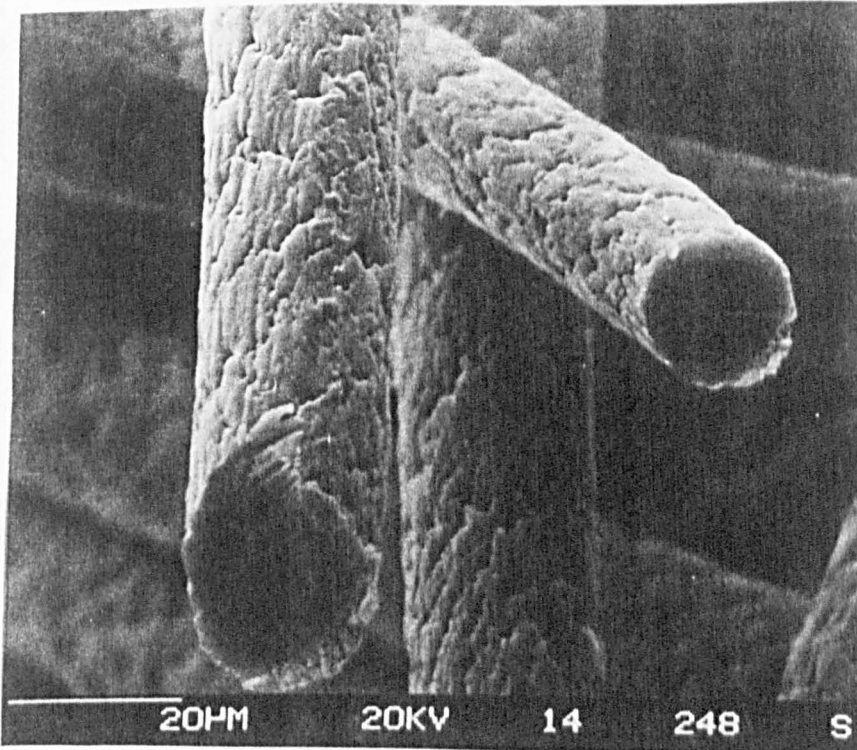

PLATE 8.1

Coagulant: 75% DMA
(75°C)

DR: 4% (Air)

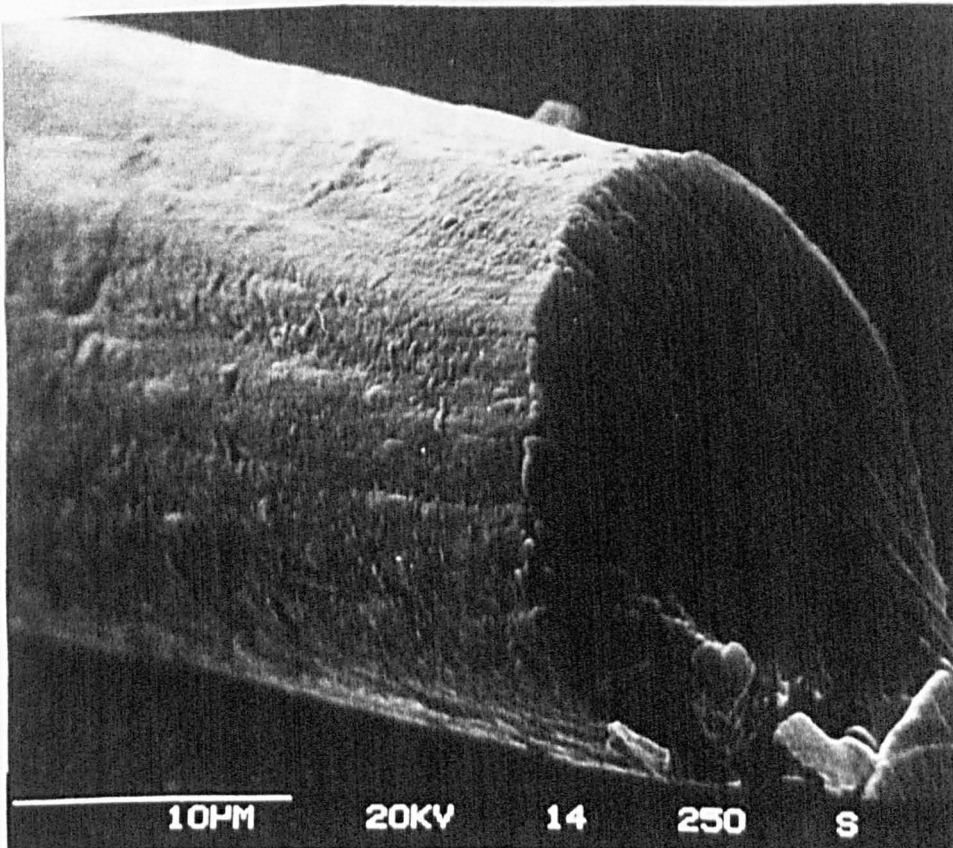

PLATE 8.2

Coagulant: 75% DMA
(75°C)

DR: 4% (hot
water)

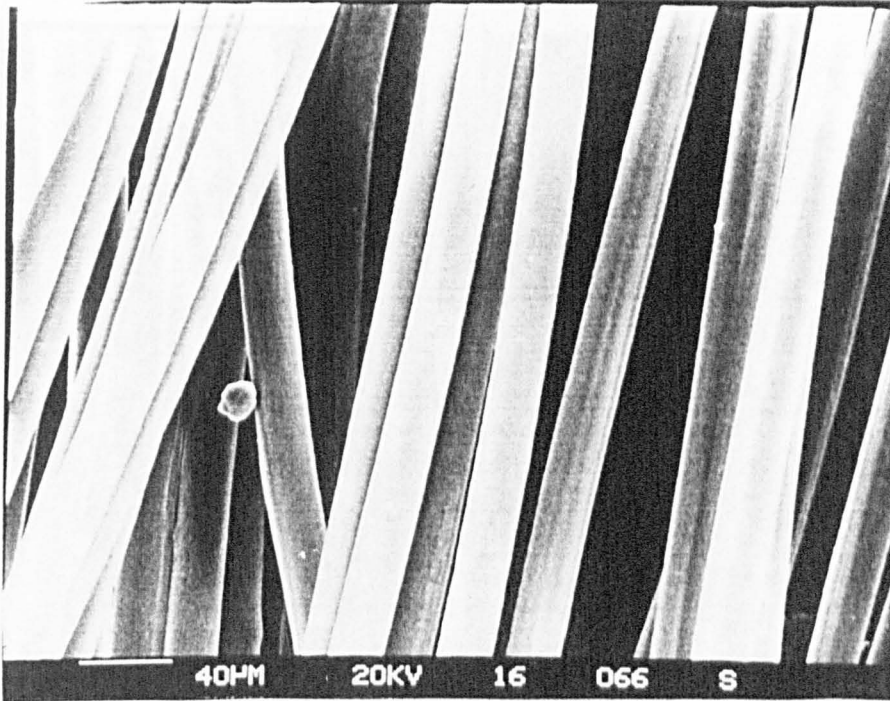

PLATE 8.3

DR: 20%(hot water)

Coagulant: 75% DMA
(75°C)

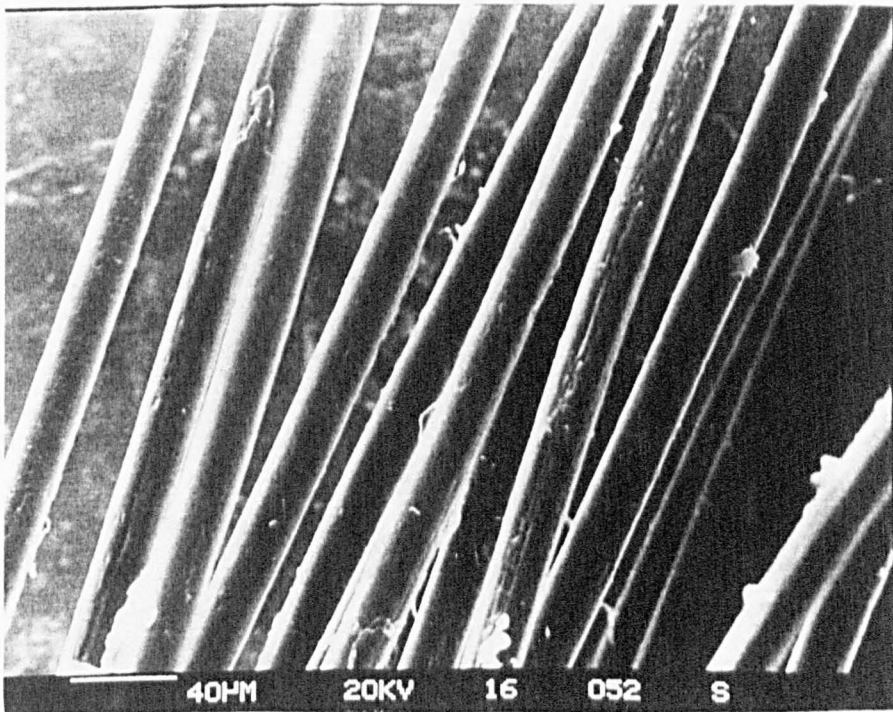

PLATE 8.4

DR: 20% (air)

Coagulant: methanol

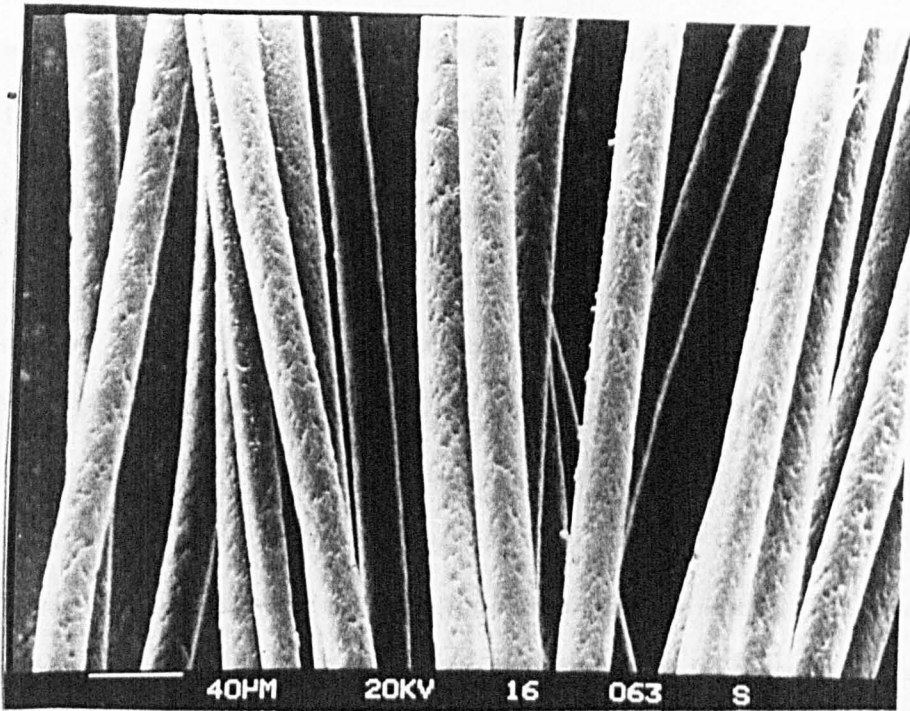

PLATE 8.5
Coagulant: Butanol
DR: 20% (Air)

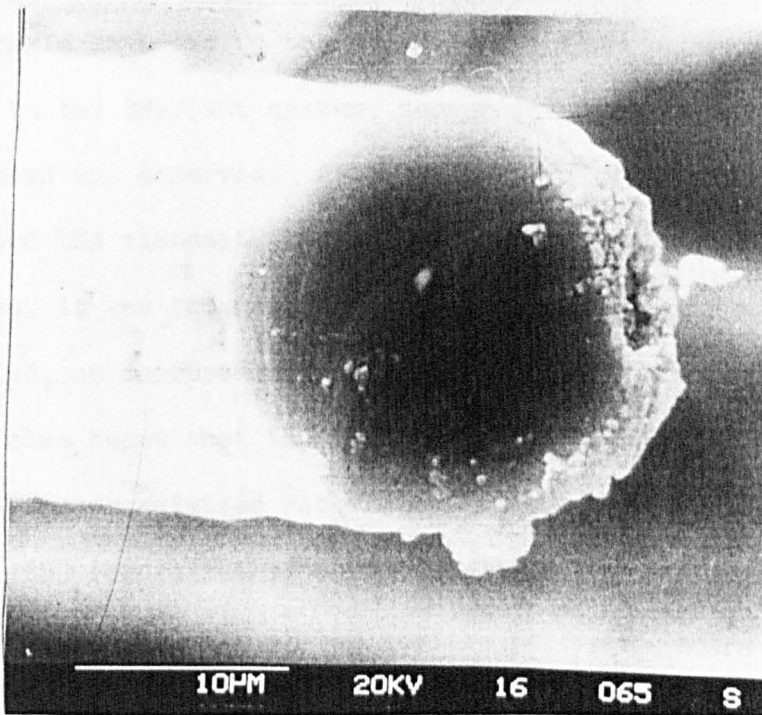

PLATE 8.6:
Coagulant: Butanol
DR: 20% (Air)

section 7.3.4 had rough surfaces and were dull. The cross-sections were virtually the same with those of pure chitin, nearly circular with no apparent signs of macrovoids.

8.3.3 Effect of addition of water to the dope

Some of the early attempts to spin chitin fibres were claimed to have been marred by rapid gelation of dope solutions on exposure to atmospheric moisture [205]. Although this was hardly ever encountered during all the normal spinning attempts made in this work (in spite of the fact that neither the chitin samples nor the DMA used was dried), it was realised soon enough that addition of water to the dope caused an increase in dope viscosity, which led to gelation either on further exposure to atmospheric moisture or on heating. But a preliminary investigation into the effect of water showed that about 2.5% (w/w) water could be added to the dope without lowering the solubility of the chitin in the DMA/LiCl system, though at this concentration a faint cloudiness was observed. Although the addition of water to the dope increased the viscosity and also acted as a quicker means of inducing gelation, it was thought that if it was possible to spin the dope before it gelled, an improvement in the fibre properties might be possible. (It was also hoped that the incorporation of water in the dope might result in a faster coagulation rate. Similar results reviewed by Strathmann et al [165] for cellulose acetate-acetone casting solutions showed that the degree of porosity of the acetate membrane increased with increasing water content in the solution. Based on a phase diagram of cellulose acetate-acetone-water, it was indicated that the casting solution with, say, 15% water already contained so much water that gelation occurred

rapidly in the presence of only small amounts of water, resulting in porous membrane.) Following these ideas dopes containing either 1.4 or 2.5% (w/w) water were prepared. The viscosities of the dopes were measured at room temperature and also at 60°C. The measurement at 60°C was to determine the stability of the dopes, and whether it would be possible to spin them above room temperature.

Table 8.13 shows the results of the viscosity measurements obtained. It is obvious from these results that heating the dope containing 1.4% water increased the viscosity greatly, and it had to be avoided. The dope gelled within 2 hours of heating at 60°C. Apart from this problem, the viscosity of the dope at room temperature was quite satisfactory for spinning. However, too much exposure to atmospheric moisture was avoided. As for the dope containing 2.5% water, it was very difficult to prevent gelation even at room temperature; accordingly, no attempts were made to study dopes containing 2.5% water.

It was next considered worthwhile to spin the dope containing 1.4% water. Table 8.14 shows the results obtained. The fibres were spun into various coagulants and were undrawn, but relaxed in a hot water bath, then in methanol before drying. The results show that addition of water to the dope appears to have no effect on the mechanical properties of the fibres spun from the dope at room temperature. Examination of the fibre cross-sections under the microscope did not show any apparent sign of voids, indicating that very little change, if any, occurred in the rate of coagulation with the addition of water to the dope. Fibres spun from dope at 60°C were also apparently voidless. However, it appeared that heating the dope to 60°C was not beneficial

Table 8.13: Effect of addition of water to the dope on dope viscosity

Amount of water added (%, (w/w))	Dope viscosity (3.6 sec^{-1}), Pas)	
	25°C	60°C
none	62	15
1.4	72	85*
2.5	91	-

Dope concentration: 7% (w/w) chitin; 8% (w/w) LiCl

*Measured after allowing 30 minutes for temperature equilibration.

TABLE 8.14: Effect of addition of 1.4% water to the dope on the mechanical properties of undrawn fibres

Sample No.	Coagulant	Fibre diameter (μm)	Fibre count (dtex)	Tenacity T (g/dtex)	Extensibility E (%)	Tensile factor $TE^{\frac{1}{2}}$
7-7*	DMA/water	35.7	14.0	0.78	64.0	6.24
8-77	75/25 (25°C)	33.0	12.6	0.80	70.0	6.70
8-78 ⁺		34.0	12.6	0.60	63.3	4.77
7-12*	Methanol	30.5	9.8	0.92	65.0	7.42
8-79		30.0	9.8	0.83	58.0	6.32
7-16*	Water	32.5	11.5	0.82	51.0	5.86
8-80		32.0	11.5	0.82	57.0	6.21

* Pure chitin dope (data from Table 7.3)

+ Dope at 60°C for 1 hour. Spun before gelation occurred.

Spinning conditions: Dope spun on the 4th day
 First advancing reel: 24.5 m/min
 Second advancing reel: 12.7 m/min
 Hot water draw bath temperature: 85°C
 Number of turns on the rollers: nil

as it results in a lower tenacity value. Thus, the most serious problem observed was the ease of gelation on heating; otherwise the dope spun very well. During gelation, it was observed that the dope delivery rate was irregular and this resulted in frequent fibre breakage.

From these results, it is obvious that under the conditions examined, the presence of a small amount of water in the dope does not pose a serious problem during spinning. Under such conditions, the DMA used contained about 0.1% water and chitin samples about 9% water content. Hence a typical dope (40 g chitin-45.7 g LiCl-470g DMA) would contain 0.73% (w/w) water.

Finally the effects of addition of the plasticizers or water to the dope as co-solvents can be summarized as follows:

(i) It has been found that the plasticizers examined can be roughly divided into two groups. The first group comprising of DMP, DEP and TPP was found to mix better with chitin dopes. Such dopes obtained had viscosities slightly higher than that of pure chitin except the dope containing DEP, which gave a slightly lower viscosity. It appeared also that addition of these plasticizers to the dope improved the spinning process as less fibre breakage was obtained, especially when the fibres were drawn in air. The properties of the fibres obtained showed higher tenacity values than those of pure chitin, especially at low draw ratios (<12%) in contrast to slightly lower extensibility values. However, the differences in tenacity values between pure and plasticized fibres at high draw ratios were quite small.

(ii) The second group comprised of DEB and DIOP. These were not considered very important as they were slightly less miscible with the dopes and caused frequent fibre breakage as a result of the weak fibres produced.

(iii) It was found that only methanol, 75% DMA and butanol baths could be used as coagulants for the plasticized dopes. Fibres spun into water were opaque and generally too weak to spin continuously, presumably because the plasticizers were insoluble in water. In each case, methanol and 75% DMA were most favoured. With the 75% DMA bath, it was observed that an increase in the bath temperature was again important as the fibre properties (including tenacity) were observed to increase. With pure chitin dope, the effect of bath temperature on tenacity was negligible.

(iv) The long methanol soaking of the samples was an effective way of removing the plasticizers from the fibres as confirmed through UV absorption measurements. This was interpreted to mean that the plasticizers were not bound tightly to the chitin.

(v) The electron micrographs of the fibres showed no significant differences between the pure and the plasticized fibres.

(vi) Addition of water to the dope resulted in an increase in the dope viscosity and ease of gelation. However, dopes containing about 1.4% (w/w) water can be spun to give fibres with properties very little different from normal dopes.

CHAPTER 9

FINAL SUMMARY AND CONCLUSIONS

9.1 Dope preparation

In solution spinning, the polymer must, first of all, be dissolved. The extent to which this can be achieved depends, among other factors, on the molecular weight of the polymer. It is obvious from the molecular weight data ($\bar{M}_w = 0.4 \times 10^6 - 3.5 \times 10^6$; DP 2,000 - 17,000) shown in Table 4.4 that chitin is a very high molecular weight polymer. Thus, the lack of success in producing fibres from the 'solutions' of the original chitin could be ascribed almost entirely to the incomplete dissolution of this polymer at all concentrations examined. Now, the structural similarity between chitin and cellulose makes it inevitable that they should be compared. Like chitin, the high molecular weight of cellulose ($5 \times 10^5 - 1.3 \times 10^6$; DP 3,000 - 8,000 [206]) makes dissolution very difficult. It is in recognition of these difficulties that cellulose is always degraded in the making of regenerated cellulosic fibres. The degree of polymerisation of such cellulose derivatives is usually between 250 and 800 (molecular weight 49,000 - 130,000) [194]. Surprisingly, most other commercial fibres are spun from polymers with degrees of polymerisation far less than 800 (eg. nylon 6.6, 50-80, polyester 100-140 and acrylic 1400-2500). It was therefore considered necessary to find a means by which the molecular weight of chitin could be lowered. This led to the use of p-toluene sulphonic acid (TSA) in isopropanol (IP) to depolymerise chitin, and it was shown that the result obtained was the single most important effect noted during this work. The acid treatment was capable of depolymerising chitin quite rapidly from a molecular weight of about 2×10^6 (DP 9800) to almost a constant molecular weight of about 1.5×10^5 (DP 740) within a treatment time of 2 hours, independent of the quantity of chitin

used. The treatment was recommended to Dr. G.C. East by Searles Ltd., presumably after they had tried without much success to obtain fibres from chitin. However, when contacted they suggested Professor P.R. Austin as the original inventor. Unfortunately, Prof. Austin was not even aware of the treatment. This procedure of acid-catalysed degradation was very reproducible, the only disadvantage being that the degradation was limited to a narrow range of possible DP values. (Similar phenomena have been noticed in the heterogeneous acid treatment of cellulose to obtain microcrystalline cellulose [207]. Why the DP should be limited is not clear, but in the case of chitin, it could be that only the amorphous regions of the polymer were attacked by the acid leaving "microcrystalline" chitin. Alternatively, it could be that the chitin is composed of blocks of NAG-linked together by a small number of easily hydrolysed units, for example, amino-acid residues. But, if the chitins used were not properly deproteinised, a further treatment in sodium hydroxide should have been all that was required. However, although such a treatment had the effect of producing whiter chitin flakes, it never gave chitins that were completely soluble in DMA/LiCl, and therefore did not lower the molecular weight to any great extent. On the other hand, it should be noted that chitin is claimed to contain always a certain percentage of protein even after the most severe alkali treatment. It could be, therefore, proposed that TSA/IP is capable of penetrating into some specific regions in chitin to cause chain scission, presumably where proteins are bound to chitin. There is a report of a similar but more effective and perhaps drastic method of reducing the molecular weight of chitin (down to about 75,000-5,600, DP 27-370) which is obtained using phosphoric acid in iso-propanol

[61-63]. The product obtained is the so-called microcrystalline chitin. However, it should be noted that chitin, when dissolved in 85% phosphoric acid forms oligosaccharides which are to some extent deacetylated [29]. In the case of TSA/IP treatment, the present study has shown through the comparison of infrared spectra, elemental analysis, and acetyl content that the N-acetylglucosamine groups were not significantly affected.

After this treatment, chitin became completely soluble in DMA/LiCl and solutions obtained were very homogeneous, easily filtered and degassed. Furthermore, higher solids content up to 10% (w/w) could be obtained. The conclusion appears to be that it is necessary in attempting to prepare spinnable chitin solutions to first of all reduce the molecular weight by treating, if necessary, in TSA/IP. Perhaps the DP obtained in the present work is not yet within the optimum range obtainable, in which case, a modification in the treatment procedure could lead to a further reduction in DP. The effect this will have on the fibre properties is not known, though the present results from chitins treated for various times was not very encouraging. However, the range of molecular weights employed was very small, in spite of the differences in the viscosities of the samples, especially between those treated for 30 minutes, and 6 hours. The results were shown in Table 7.3.

9.2 Dope characterisation

Initially, the rheological behaviour of the original chitin samples in DMA/LiCl, when compared with the behaviour of a well established spinnable polymer such as an acrylic showed considerable

differences. Whereas the acrylic polymer dope was almost Newtonian except at shear rates above 14 sec^{-1} , even at 20%, the chitin solution was profoundly non-Newtonian at 1%. The differences must be associated with the high molecular weight of the chitin as the solutions of TSA/IP treated samples were observed to exhibit rheological properties very similar to those of an acrylic/DMF solution (20% w/w). Based on the data extracted from the plots of $\log \eta$ versus $\log C$, the viscosity of such chitin solutions were expressed in the form $\eta = KC^{4-4.5}$ at shear rates below $\sim 7 \text{ sec}^{-1}$, indicating a close similarity with other polymer solutions especially cellulose tributyrate and trinitrate [160]. The expression is also almost the same with that obtained by Ovitigala [208] for Orlon ($\eta = KW^{4.35}$ where W is the % polymer content (w/w) and $\log_{10}K = -4.08$). However, the activation energy for viscous flow, E_v , he obtained for 15-25% Orlon was about $6.2 \text{ Kcal mol}^{-1}$. A value of $9.2-9.9 \text{ Kcal mol}^{-1}$ was obtained for 5.2-9.8% chitin, indicating that the effect of temperature on chitin dopes was much more significant than on the acrylic polymer dope. But cellulose triacetate in acetone with an activation energy of $8.5-10.4 \text{ Kcal mol}^{-1}$ [160] was very comparable with the chitin dope. So, it was expected that the spinning of treated chitin solutions should be comparatively as simple as with these polymer solutions. However, the narrow range of solids contents practicable and the tremendous increase in dope viscosity with a slight increase in solids content above 8% chitin, coupled with the ease of gelation above 8% chitin, were limiting factors to the spinning of chitin dopes. Besides, increases in the LiCl concentration in the dope was observed to increase the dope viscosity and the salt was always required in considerable molar excess to N-acetylglucosamine units,

the minimum being about 2.7:1 (LiCl:NAG).

One of the aims of this study was to investigate whether liquid crystals could be formed in the chitin/DMA/LiCl system by studying the rheological properties of the solutions. Chapter 5 gives the results of the rheological studies under different conditions, from which it was indicated that no signs of mesomorphic phases was detected. It could be that the solvent system is not suitable for formation of such phases. It is known that cellulose dissolves in DMA/LiCl and such properties have not been reported for cellulose either.

The possibility of adding other liquids as eg. co-solvents, was briefly explored in this study. Small amounts of water were deliberately added, without noticeable advantage. More useful was the addition of plasticizers of the phthalate type; in quantities up to 6% on the weight of dope; diethyl phthalate caused no precipitation and, at lower concentrations, gave some advantages both in ease of spinning and in fibre properties.

9.3 The spinning process

The wet spinning and dry-jet wet-spinning (DJWS) techniques were used in producing the fibres. It was found that a continuous spinning process could be established by employing solids content between 5 and 10%, although solids content between 6 and 9% was most suitable when spun at room temperature. This range of solids content (6-9%) with about 8% LiCl, corresponded to dope viscosities between 16 and 100 Pa s at 25°C, 3.6 sec^{-1} (for C3 treated for 6 hours). However, it should be noted that a change in LiCl concentration, and a change in the treatment time and grade of chitin will inevitably affect the

viscosity values given above. The most convenient way to degass such dopes was by storing under moisture free conditions for about 1 week. This process was found to lead also to a gradual increase in viscosity to a more or less steady value and improved spinnability. However, a more extensive study of the effect of ageing is clearly required to confirm these results.

The spinning process was carried out on an acrylic spinning plant. As such, some difficulties were encountered, particularly in the use of the high capacity metering pump ($1 \text{ cm}^3/\text{rev}$). It was almost impossible to wet spin using this pump unless spinnerets with very large hole diameters and/or a very large number were used. Early trials used a $150 \mu\text{m}$ 10 hole spinneret which limited the extrusion rate to lower than 17 m/min. With chitin being a very slow coagulating polymer, coupled with relatively inadequate washing facilities, the use of such spinnerets for wet spinning gave fibres with low tenacity values. On the other hand, the use of lower spinneret hole diameters meant that such spinnerets must have a high number of holes if very high extrusion rates were to be avoided. As it so happened, only an $80 \mu\text{m}$, 20 hole spinneret was initially found satisfactory among the spinnerets available, and even so, the minimum rate of extrusion was almost 30 m/min. At this speed or above, it became very difficult to control the spinning process. Among other reasons, it became even more difficult to spin continuously due to breakages and excessive time required to achieve a speed balance between some of the rollers. Such time could not always be spared due to the limited quantity of dope. However, later when the spinning process was better understood, conditions were established which reduced filament breakages and permitted the

use of even a 50 μm 40 hole spinneret (at an extrusion rate of 38 m/min), though nothing could be done about the problem of speed balancing.

The major problem encountered which remained insurmountable, was associated with the coagulation of the chitin solution. It is believed that the rate at which chitin solutions coagulate is far too slow for an efficient spinning process. Many coagulants were tried and more or less the same results were always obtained; filaments were heavily swollen, easily stretched under tension and broke easily on attempting to stretch. Filaments also adhered together on drying on the chrome rollers. Surprisingly though, no adhesion of the filaments was observed in the bath (except when a high DMA content was used) or on the rollers during washing, indicating that very rapid surface coagulation of the fluid thread lines must have occurred. Indeed, a two-stage coagulation process has been proposed:

- (a) involving the rapid skin formation mentioned above;
- (b) an almost stagnant or considerably reduced diffusion stage.

As a whole, it is believed that the second stage is so slow that the solvent becomes locked in the core of the filaments. The amount of liquid (presumed to be mostly solvent) in these poorly coagulated filaments, determined in the form of gel swell factor (GSF) showed values between 6 and 12.5. With more than 83% solvent in the filaments it is not surprising that fibre properties improved with washing, because washing is the only efficient means of removing the solvent. Unfortunately, when this was done under tension, the filaments became stretched, fibre tenacity was slightly increased, and extensibility greatly reduced. Subsequent experiments showed that not much was to

be gained by washing or drying under tension, as filaments washed and dried in a relaxed state were found to have better fibre properties, mostly as a result of increases in extensibility.

Once it became clear that the inability to establish a viable spinning process was due mostly to poor coagulation, it was decided to increase the bath temperature, as most coagulation processes are claimed to become more rapid with increasing temperature. Although the results obtained indicated even more swollen filaments, a very significant change occurred in that the filaments were obviously tougher, and therefore more resistant to deformation. The explanation was difficult, but it was presumed that the coagulation rate did indeed increase with increasing bath temperature: however, such an increase was limited only to the surface of the filaments, leading to even more solvent being trapped in the filaments. When combined with washing and drying in a relaxed state, the fibres produced were extremely extensible and easily cold drawn beyond their elastic limits. Thus, while an increase in bath temperature is considered disastrous as regards fibre properties for rapid coagulation systems, it may be the only way in which the chitin-DMA/LiCl system can be easily spun. Perhaps if coagulants much more sensitive (than water or DMA/water) to increasing temperature were used, an even better effect might have been obtained.

The recognition of the effect of tension and increase in bath temperature (for some of the coagulants) led to the establishment of a spinning process for chitin. Thus, fibres were wound once on each advancing reel and drawn in air or in a hot water bath (80-85°C). Generally, when the coagulants were at room temperature, it was found better to spin into a methanol bath. In this case, fibres were drawn

in air by 4-20% or in a hot water bath by 4-12%. Drawing in air was found to be less effective at low draw ratios than in water, presumably due to the elastic behaviour of the still highly swollen filaments. When drawn in a hot water bath, it became obvious that the coagulation process, being a dynamic operation, continued in the bath and was even more effective than in the coagulation bath due to frictional drag at the guides between which the filaments were passed. As for the coagulating baths which were heated to 40-75°C, the fibres could be drawn in air by 30% or in a hot water bath by 20% without breakages, indicating larger draw ratios than were possible using room temperature coagulation.

Having established a spinning procedure, further attempts were made to increase the drawability of the fibres. This was investigated through the addition of about 3% (w/w) of certain plasticizers to the dope. The results obtained were given in chapter 8. Although the improvement in fibre properties was not clear cut, it was observed that the use of DMP, DEP or TPP led to a noticeable reduction in fibre breakages during spinning. The fact that they were easily removed from the fibres by soaking in methanol indicates that they were not strongly bound to the chitin. However, the results obtained were by no means conclusive, and a more extensive study of the effect of plasticizers is clearly necessary.

In conclusion, the following may be advantageous before further attempts are made at spinning chitin fibres:

- (i) Reduction in the spinning speed: this requires the use of a lower capacity pump of about 0.4 cc/rev, so that with a pump speed between 3 and 27 rpm, the feed of the polymer dope from the reservoir

to the gear pump will vary between 1.2 and 10.3 cc/min. This will result in a wider choice of spinnerets and spinning speeds.

(ii) Washing: the best washing arrangements involve the use of cold and/or hot water and methanol in that order. It may be better to pass the filaments through these baths than use advancing reels immersed in washing baths, which may cause damage if fibres are undrawn. Alternatively, a water spray could be first applied to the filaments followed by a pass through a methanol bath.

(iii) Continuous spinning: the filaments are usually very swollen and a proper washing sequence, as outlined in (ii), is generally necessary if the filaments are to be dried continuously (and satisfactorily) on the machine. It is important that however the fibres are washed, the final washing should be in methanol before drying and winding. It was found that spinning proceeded smoothly when the surface speed of the driers was set at 4-5% more than that of the draw rollers and the winder surface speed adjusted to equal that of the driers.

The operational limits for both wet and dry-jet wet-spinning for all the variables considered in this study for the production of chitin fibres, are summarized in Table 9.1. The values considered to be optimum for each variable are also included in the table.

9.4 Properties of chitin fibres

Generally, chitin fibres, like other man-made fibres, can be produced to give various tensile properties. However, the difficulties associated with the coagulation which led always to highly swollen fibres, obscured the effects of most spinning conditions on the fibre properties. When undrawn in its swollen state, the fibres are easily

Table 9.1: Operational limits for the production of chitin fibres

Variable	Limits of spinning process	Optimum
<u>General</u>		
Treatment time in PSA/IP (h)	Limits unknown but 0.5-7 was found satisfactory	>1
*Solids content (% w/w)	5-10	6-9
LiCl concentration (% w/w)	5-10	5-8
*Dope viscosity (Pas, 25°C/3.6 s ⁻¹)	6-160	16-100
Ageing period for deaeration	Over 4 days	5-8 days
**Dope temperature (°C)	25-100	25-60
Draw ratio: hot water bath	0-30	12-20
air	0-40	15-30
<u>Wet spinning</u>		
Spinneret hole diameter	Limits unknown but fibres were spun with 50-300 µm	20x80 µm
Linear extrusion rate (m/min)	4-40	10-30
Jet stretch ratio	0.4-1.2	0.6-0.8
Coagulants	Various	DMA/water, 75/25 (75°C); methanol
<u>Dry-jet wet-spinning</u>		
Spinneret hole diameter	Limits unknown but fibres were spun with 150-400 µm	10x300 µm
Linear extrusion rate (m/min)	4-17	7.5
Jet stretch ratio	0.85-6	2-3
Air gap (cm)	0.5-4	1-3
Coagulant	Various	methanol

* For chitin treated in PSA/IP for 2-6 hours

** For 7% chitin, DMA/8% LiCl; chitin treated for 2 hours

stretched, indicating that the manner of handling, washing and drying are important. The range of fibre properties obtained from some selected undrawn chitin fibres are shown in Table 9.2. Some of their stress-strain curves are shown in Fig. 9.1. As expected, the stress-strain curves of the samples varied, depending on the conditions employed at the washing and drying stages. It will be seen that (excepting the unwashed sample) the stress-strain curves each have a point of inflection which varies from about 2% extension for the sample washed and dried under tension (sample 3-36) to about 5% for the rest of the samples. The curves can therefore be roughly divided into two regions. The first region is the part of the curves where the strain is proportional to the stress (linear Hookean region) and corresponds generally to an area of high initial modulus. Since initial modulus is also a measure of fibre stiffness, the fibre sample that was washed and dried under tension was much stiffer (and brittle) than the rest. Such fibres had no tendency to stretch and broke quite easily on knotting. Within this region, most of the samples, if stretched by less than 5%, are supposed to recover, but complete recovery may not occur in this case due to the "flow" process which occurs at quite low stresses [209]. Similar behaviour has been observed in viscose and acetate rayons [210]. The poor stability of unwashed fibre is indicated by a complete absence of the Hookean region as is evident from the lowering of the slope of the curve.

The second region of the curves lies in the region between the point of inflection (yield point) and the breaking extension. In this region, the curves bend towards the extension axis, the amount of bending depending on the tension which the samples had been previously

TABLE 9.2: Properties of some selected undrawn chitin fibres

Sample No.	Fibre diameter (μm)	Fibre count (dtex)	Tenacity T (g/dtex)	Extensibility E (%)	Tensile factor $TE^{\frac{1}{2}}$	Initial modulus* (g/dtex)	Breaking toughness (g.cm/dtex.cm)
Unwashed	75.0	83.0	0.25	77.0	2.20	1.6	
3-26 ⁺	58.0	37.0	0.83	40.7	5.30	16.0	
3-36 ⁺	52.0	30.0	1.23	18.8	5.33	23.0	
7-1	36.5	14.5	0.43	71.3	3.63	3.5	0.260
7-48	37.0	15.0	0.86	78.0	7.60	12.5	0.560
7-3	30.0	9.8	0.78	56.0	5.84	10.0	0.370
7-12	30.0	9.8	0.92	66.0	7.47	20.5	0.450

Fibre density: 1.386 g/cm³

Moisture content (65% R.H./20°C): 12.5% (calculated based on the TGA curves shown in appendix 2)

* at 2% strain

+ mean value

3-26 Washed and dried relaxed in oven (70-75°C)

3-36 Washed and dried under tension on chrome rollers

7-1 DMA/water, 75/25 at 25°C (relaxed in DMA/water for 24 hours)

7-48 " " " at 75°C (relaxed in hot water)

7-3 Methanol (relaxed in methanol for 24 hours)

7-12 " (relaxed in hot water)

Spinnerets: 150 μm , 10 holes (samples 3-26 and 3-36)

80 μm , 20 holes (samples 7-1 to 7-12)

FIG. 9.1: Stress-strain curves of some selected undrawn chitin fibres

- 1 Unwashed sample
- 3-36 Washed and dried under tension on the chrome rollers
(filaments wrapped around advancing reels with 15-20 turns before washing)
- 7-48 DMA/water, 75/25 at 75°C (relaxed in hot water)
- 7-12 Methanol (relaxed in hot water)

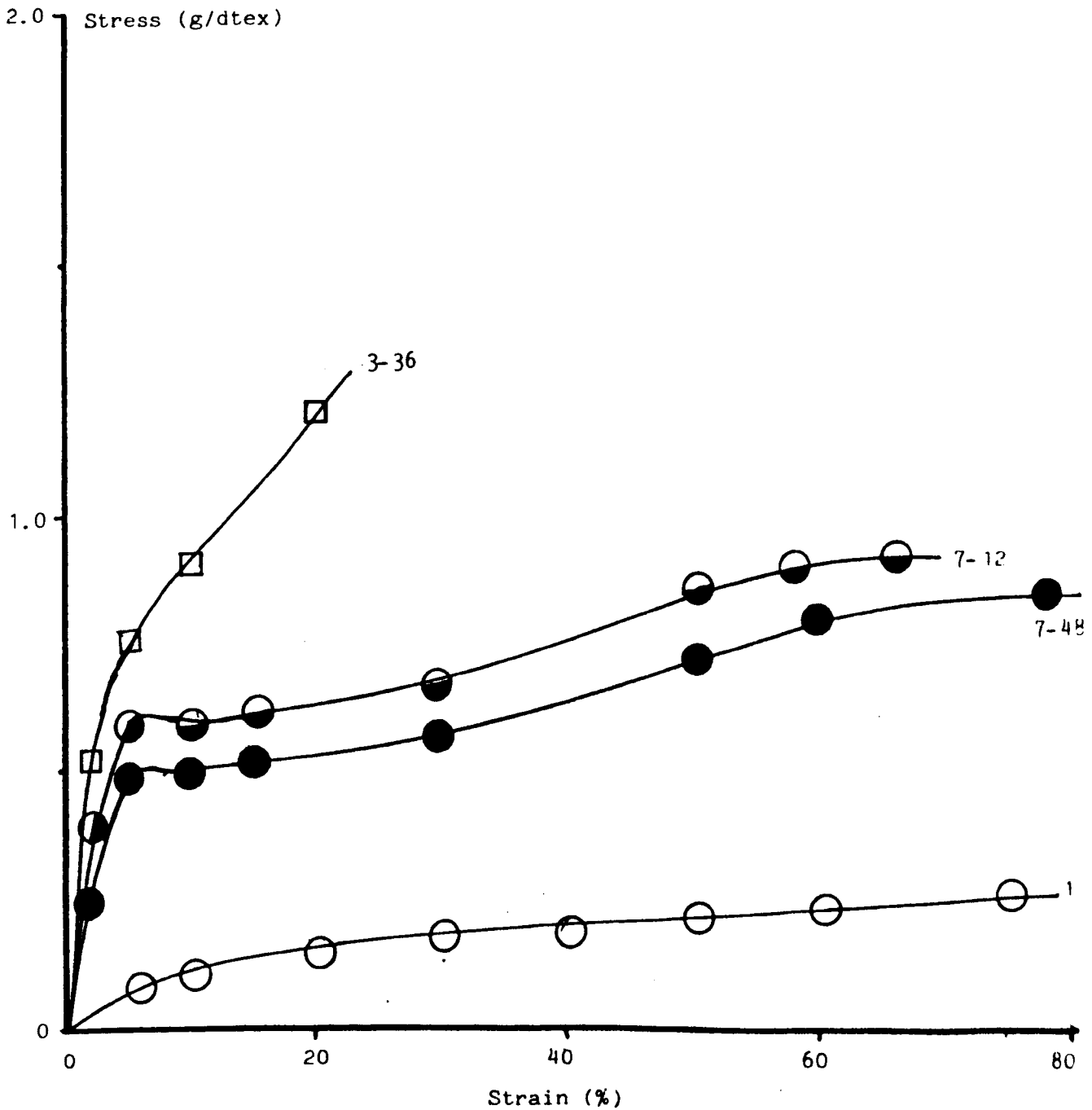

subjected to during spinning. It can be seen that apart from the sample washed and dried under tension (3-36) where no flattening occurs, the rest of the curves show the existence of small regions of almost constant stress where large extensions were produced by relatively very small increases in the stress. This kind of behaviour is observed with most undrawn highly extensible synthetic polymers capable of being cold drawn, but unlike these polymers, the flat portions are followed soon by a "strain-hardening" effect (point where the slopes of the curves begin to increase with extension). This lack of large extension or natural draw ratio (draw ratio where the yield zone ceases before strain hardening) accounts also for the marked effect of tension on the fibres. Although undrawn and dried chitin fibres can be cold drawn, the chitin structure is much more rigid than synthetic polymers like nylon and therefore it cannot be reorganised to any marked degree by cold drawing [211]. However, an interesting observation from the curves is that the fibres relaxed in hot water before storing in methanol for 2 hours, have high initial modulus (especially sample 7-12) as well as a high breaking toughness. It is obvious that these curves are evidence of the higher drawing capacity which these untensioned fibres possess when compared with the pretensioned ones. By pretensioning the fibres, the constant stress plateau observed with the untensioned fibres is completely absent and fibre stiffness and tenacity increase but the fibre extensibility decreases, reducing the chances of drawing the fibres.

By now it has become obvious that undrawn wet chitin fibres may be stretched by wrappings on the advancing reels, drying under tension or even by friction between guides; but the most effective

method of drawing is between the two pairs of advancing reels. Generally, greater orientation and crystallinity are produced in the fibres as a result of drawing. Fibres that were stretched and possessed good orientation had a high tenacity and initial modulus, but little extensibility and reduced breaking toughness. In other wet spinning systems, further improvements in the fibre properties can be obtained by changes in solids content, bath composition etc. The results obtained on spinning chitin polymer (5-9% solids) indicate that increasing the solids content did not alter the fibre properties significantly, although an optimum appeared around 7%. Similarly, increases in the dope temperature (between 25 and 100°C) and changes in the spin bath composition were found inactive for improving the fibre properties. However, the latter variable had a substantial influence on the ease of deformation of the fibres, and this appeared to increase with increasing DMA content in the bath. Under such conditions, it was found that increases in the bath temperature to between 40 and 75°C improved the fibre toughness and made it possible for such fibres and also those spun into water baths to be drawn. Increase in bath temperature produced also a significant improvement in fibre extensibility, but had more or less no effect on tenacity.

Table 9.3 shows the tensile properties of some selected drawn fibres. Their stress-strain curves are shown in Fig. 9.2. These results show that although the fibre tenacity has increased by stretching, those fibres spun into 75% DMA and methanol baths have become very stiff as is evident from the reduction in the values of extensibility and breaking toughness, and increased values for initial modulus. These were of attractive handle and appearance, the attractive appearance

TABLE 9.3: Properties of some selected drawn fibres

Sample No.	Draw ratio (%)	Fibre diameter (μm)	Fibre count (dtex)	Tenacity T (g/dtex)	Extensibility E (%)	Tensile factor $\text{TE}^{\frac{1}{2}}$	Initial modulus* (g/dtex)	Breaking toughness (g.cm/dtex.cm)	Coagulant
7-57	20	24	6.5	2.14	13.5	7.86	39.5	0.190	75% DMA (75°C)
7-60	(30)	(25)	(7.0)	(2.00)	(17.3)	(8.32)	(30.5)	(0.199)	"
7-27	12	23	5.9	1.91	11.8	6.56	34.0	0.130	Methanol
7-30	(20)	(22.5)	(5.6)	(1.93)	(9.4)	(5.90)	(39.0)	(0.098)	"
7-32	(15)	(26.5)	(7.8)	(1.43)	(29.4)	(7.75)	(14.5)	(0.185)	Butanol
7-63	30	28	8.5	1.64	28.9	8.82	18.5	0.330	Water (75°C)
7-91 ^a	30	35.5	14.0	1.80	7.0	4.70	44.5	0.128	Methanol
8-23 ^b	(20)	(20.0)	(4.5)	(2.10)	(8.2)	(6.00)	(54.5)	(0.102)	Methanol

425

() Drawn in air

Fibre density: 1.395 g/cm^3

Moisture regain (65% R.H./20°C): 10-12.5% (see appendix 2)

a DJWS: air gap 1.5 cm; jet stretch ratio 4; spinneret $10 \times 300 \mu\text{m}$

b chitin/DEP

*At 2% strain

FIG. 8.2: Stress-strain curves of drawn chitin fibres

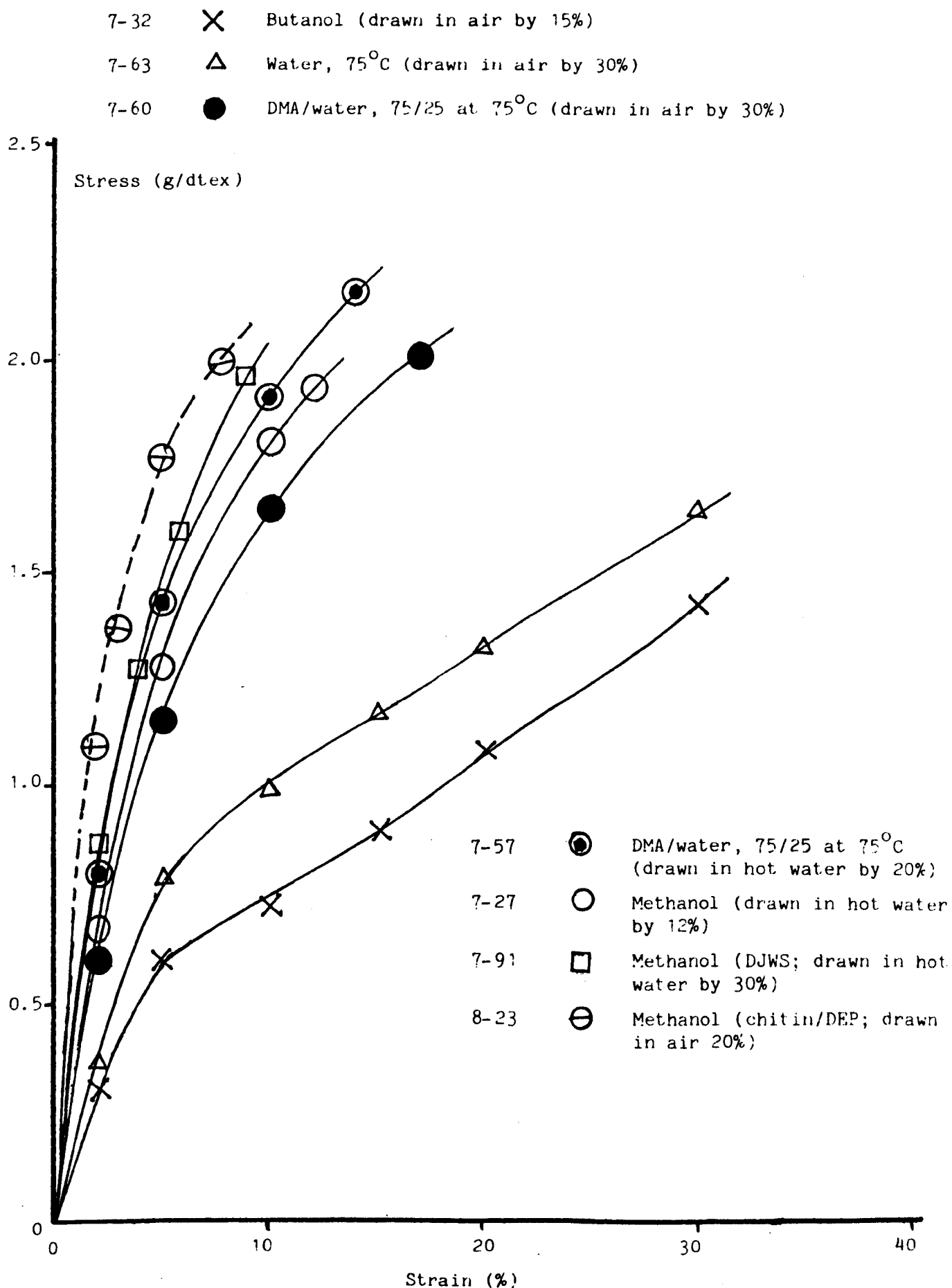

being associated with their surface smoothness. In comparison with the undrawn fibres, the change in surface appearance of these fibres was quite remarkable as the former were observed to possess irregular furrows which appear like deep cracks all over the surfaces. Although the cause of the peculiar surface was not clear, it was ascribed mainly to shrinkage along the fibre axis during drying. Its absence in these drawn fibres may have been due to better structural compactness as evident from their high orientation. On the other hand, fibres spun into butanol and water baths, even when drawn by 20-30%, still possessed high extensibilities and breaking toughness, but were dull and easily stretched as a result of their low modulus values. Their surface appearances, like the undrawn fibres, were furrowed, but less pronounced. It is not clear why fibres spun into these two coagulants could not be effectively drawn. However, it was observed that when undrawn and in their swollen state, the fibres were more elastic (than fibres spun into methanol or 75% DMA) and probably contracted during washing and drying. Similar behaviour was observed with all the fibres drawn by 4% in air.

Apart from the extremely lustrous appearance and surface smoothness of the dry-jet wet-spun fibres in both their undrawn and drawn states, their mechanical properties were not significantly different from those wet spun. However, when spun at a high jet stretch ratio of about 4, and drawn by about 30% (using methanol as coagulant and a 300 μm , 10 hole spinneret), very high orientation could be produced in the fibres. The failure of the dry-jet wet spinning technique to improve fibre properties contrasts with the acrylic fibre system. With acrylic fibre spinning, where dry-jet wet-spinning has considerable success, the main advantage in comparison with wet spun fibres lies in

the higher extensibilities of the fibres produced under most spinning conditions. This higher extensibility allows the dry-jet wet-spun fibres to accept a higher draw ratio than the wet spun fibres, resulting in higher fibre tenacities. In chitin spinning, by contrast, it was observed that dry-jet wet-spun fibres always had lower extensibilities than the wet spun ones, i.e. the higher the jet stretch, the lower the extensibilities. This must be associated with the fact that a degree of orientation was produced by the dry-jet wet-spinning, which was mostly carried out at higher jet stretch ratios.

The effect of the addition of plasticizers to chitin dopes on the fibre properties are given in chapter 8. From such results, it appeared that dimethyl phthalate (DMP), diethyl phthalate (DEP) and triphenyl phosphate (TPP) had more positive effects on fibre tenacity and spinnability than either dibutyl phthalate (DBP) or diiso-octyl phthalate (DIOP). Considering the behaviour of the phthalate plasticizers, one is tempted to propose that their effects on fibre properties may be influenced by their molecular weights, with those having molecular weights above that of DEP (222) being the least attractive. Apart from the slight differences in tenacity and extensibility values, the fibres produced were characterised by similar features as outlined for those spun from pure chitin dopes. However, it appears from Table 9.3 and Fig. 9.2 that the fibres produced from chitin/DEP dope and spun into methanol (and drawn in air by about 20%) may possess the highest resistance to stretching as measured by the value of the initial Young's modulus obtained. However, they were relatively brittle.

The lack of reference in the literature to the spinning of chitin fibres from the DMA/LiCl system has prevented a more specific comparison with the chitin fibres obtained in this work. It was only towards the end of this work that an article was found which related to the production of chitin fibres from DMA/LiCl using butanol as coagulant. Unfortunately, only very little practical detail of the spinning process was described. The fibres produced were very small in diameter, about 5 μm from a 50 μm spinneret, ie. 0.27 dtex. The number of holes was not given, but multifilaments of about 50 kg/mm^2 (3.71 g/dtex assuming a density of 1.4 g/cm^3) in strength were claimed. (If one assumes that a 50 μm 40 hole spinneret was used, then the strength of a single filament would have to be about 0.1 g/dtex. This value seems far too low.) "Then 16 or 20 bundles of the filaments were braided, rinsed, coated with a surfactant" to give sutures of standard size 3-0 and 4-0, tenacity about 1.86 kg/mm^2 (0.13 g/dtex) and elongation of about 8-9%. It is not very clear what these tensile properties refer to, but with a tenacity value of 0.13 g/dtex, it is tempting to suggest that some misleading data has been given.

Table 9.4 gives a comparison of the properties of chitin fibres obtained from various solvents with those produced in this study. It can be seen that apart from the results obtained by Kifune et al [97] in 1984, using trichloroacetic acid (TCA)/methylene chloride (MC), all the fibres produced before the present work had tenacities that varied between 0.54 and 1.43 g/dtex, and extensibilities between 2.7 and 11.2%. Although some of the fibres (prepared from formic acid (FA)/dichloroacetic acid (DCA)/isopropyl ether (IP) system) could be drawn by up to 35%, their extensibilities were very low (2.7%). The most significant.

TABLE 9.4: Comparison of properties of chitin fibres from various solvents

Solvent	Solid content (%)	Draw ratio (%)	Fibre count (dtex)	Tenacity (g/dtex)	Extensibility (%)	Author	Reference
Alkali				0.54-0.90		Balassa and Prudden (1978)	86
Alkali	5		3.4-19.8	0.81-1.37	3.9-11.2	Noguchi et al (1978)	90
FA-DCA (92:8)	3-4	10-32	3.6-28.3	0.61-1.19	2.7-2.9	Tokura et al (1979)	93
FA-DCA-IPE (92:5:3)	4.6	29-35	2.2-2.3	0.92-1.20	2.8-4.3	" " "	"
FA-DCA-IPE (83:3:5)	3.8	20-35	2.2-3.3	1.13-1.43	2.7-3.4	" " "	"
DCA:MC	3	tensioned	1.83-1.89	1.49-1.50	8.7-8.8	Kifune et al (1984)	97
	3	relaxed	1.94-2.37	2.0-2.89	18-28.4	" " "	"
	3-5	20-40	1.17-1.29	3.69-3.91	-	" " "	2
DMA/LiCl	5-9	undrawn (tensioned)	6-9	0.73-1.20	15-28	Present work	
		undrawn (relaxed)	9-16	0.74-0.98	47-78	" "	
		10-30	4-7	1.24-2.26	7.0-33	" "	
		40-10(DJWS)	14-77	1.2-2.0	24-7.0	" "	

Footnote: FA formic acid; DMA dimethylacetamide;
DCA dichloroacetic acid; LiCl lithium chloride;
IPE isopropyl ether; MC methylene chloride

work on chitin spinning was that reported by Kifune et al [97], also towards the end of the present study. Similar effects of tension observed in this work were also reported by Kijune et al. The essential features of their spinning process have already been reviewed in chapter 1. In one of the examples quoted, fibres which were spun and wound 20 times around a roller immediately they were withdrawn from the first coagulation bath, were shown to have a tenacity of 1.5 g/dtex, extensibility 8.8% and linear density of about 1.8 dtex. However, similar fibres spun but relaxed on a conveyor immersed in a second coagulation bath or in a u-tube containing the required coagulant were claimed to have tenacities of 2 and 2.9 g/dtex, extensibilities between 18 and 28% and linear densities between 2 and 2.4 dtex. While the effect caused by winding the fibres on the roller on extensibility and linear density were similar to the results shown in Tables 7.2 and 7.3, the effect on tenacity was quite the reverse. Although the fibre properties quoted make the superiority of their process self-evident, it was not clear how such high values of tenacity could be obtained from fibres which were not clearly shown to have been drawn. However, it is possible to summarise some obvious differences from the present study:

(i) In their work a higher molecular weight chitin was used. This is shown by their data which stated that an 0.2% (w/w) solution of the required chitin (dissolved in DMA/10% LiCl) should have a viscosity between 300 cP and 1,500 cP at 30^oC. This is quite a high viscosity for only a 0.2% chitin solution, disregarding the fact that not all the chitin would necessarily be soluble in DMA/LiCl. From such a high molecular weight chitin, one would have thought that the spinning dopes

(containing 3-5 parts by weight of chitin) would have too large a viscosity for spinning unless the solvent mixture caused degradation. That this does occur is shown in appendix 1. In comparison, the viscosity of an 0.2% (w/w) untreated chitin (C2) in DMA/10% LiCl estimated using the procedure described in section 2.1.2, was only 36 cP (for the dissolved portion, about 65%). A similar experiment carried out for 0.2% (w/w) C2-2 in DMA/10% LiCl gave a viscosity of 7 cP using water in each case as a comparative liquid. It is obvious from these results that the chitin samples used in the present study (both treated and untreated) gave solutions with much lower viscosities than those used by Kijune et al.

(ii) According to Kifune et al, the amount of residual solvent in the extrudates before relaxing in the second coagulation bath was required to lie between 10 and 50% by weight. In the present study, the amount of solvent left in the filaments could not be clearly established, though as was shown in chapter 6, the extrudates were usually highly swollen after coagulation.

(iii) They used TCA/MC as solvent instead of DMA/LiCl.

Table 9.5 shows the comparison of drawn chitin produced in this study with some typical commercial fibres.

Finally it is regretted that time has not allowed for the determination of the wet properties of the fibres spun after the preliminary studies. However, it is hoped that such tests will be carried out in the future.

TABLE 9.5: Comparison of drawn chitin fibres with some typical commercial fibres

Fibre	Fibre count (dtex)	Specific gravity	Moisture regain* (%)	Tenacity (g/dtex)	Extensibility (%)	Initial modulus (g/dtex)	Work of rupture (g.cm/dtex.cm)
Cotton	1-2	1.54	7-8.5	2.3-4.5	3-10	36-75	0.18
Wool	4-10	1.32	14-16	0.9-1.8	30-45	22-36	
Viscose rayon	1-9	1.52	12-16	1.5-4.5	9-36	45-70	0.27
Cellulose acetate	5	1.30	6-6.5	1.0-1.26	23-45	23-37	0.20
Cellulose triacetate	4	1.30	2.5-3	1.1-1.26	25-40	32-41	
Acrylic	2-6	1.17	1.5	1.8-4.5	16-50	36-50	0.45
Polyester	2-5	1.38	0.4	2.5-5.5	10-45	90-135	0.90
Nylon 6.6		1.14	4-4.5	3.6-8	16-45	23-45	1.53
(Alginate (calcium))		1.78	17-23	0.9-1.80	2-14		
Chitin ⁺	4-7	1.39	10-12.5	1.2-2.30	7-33	26-54	0.1-0.3

* at 65% R.H. and 20-21°C

+ present work (wet spun)

9.5 Suggestions for future work

1. The present work on the production of fibres from chitin has shown that fibres of enhanced mechanical properties can be prepared. However, this was only possible after the original chitin sample had been depolymerised using TSA/IP. A great drawback to the use of TSA/IP was that it failed to give DPs lower than a certain value. A method by which chitin can be degraded to obtain a wider range of DPs for fibre spinning would be worth investigating.
2. If required, a concurrent study of the effects of molecular weight, concentration and temperature on the viscosities of chitin solutions can be undertaken and from such a study a relationship perhaps of the form $\eta \propto C^{4-4.5} M^{3.4-3.5}$ can be established for chitin.
3. The difficulties encountered in this work during the spinning process can be almost entirely associated with the poor coagulation of the fluid threadlines. It seemed pertinent therefore, that the coagulation process should be examined in more detail. As mentioned in chapter 6, no attempt was made to determine the composition of the liquids in the highly swollen filaments and this had prevented a more accurate prediction of the coagulation mechanism. The entire diffusion process could be studied by using a method similar to that described by Paul [162] and Booth [171]. Different coagulants could then be examined, especially those that have boiling points above 100°C. This could also be extended to determining the effects of the addition of other liquids to the dope on the rate of coagulation. The role of coagulation is surely very important as it determines not only the properties of the fibres spun but also the dynamics of the spinning process.

4. The following suggestions related to the spinning process and fibre aftertreatments could also be studied:
 - (i) effect of coagulation bath temperature using organic coagulants with high boiling points;
 - (ii) continuous spinning process including drying and winding on the spinning plant;
 - (iii) drawing in steam and/or hot baths other than water. It may be advantageous during drawing in hot baths to use frictionless rollers as fibre guides instead of glass rods in the form of hooks to reduce frictional contacts;
 - (iv) steaming of dried fibres in relaxed and under tension in packages.
5. Now that it has been shown that chitin fibres with reasonable strength can be prepared, it would be interesting to investigate their performance as sutures and dressings.
6. The success of Kifune et al [97] using a mixture of trichloroacetic acid and methylene chloride as solvent, suggested that the chlorinated solvent system might be a more effective solvent for making fibres from chitin. Future work could be carried out to clarify the ease of spinnability and fibre qualities with those using DMA/LiCl as solvent. Also important is the effect of the source of chitin on fibre properties. It has been claimed that chitin from certain sources gives fibres with better properties than others [57].

APPENDIX 1

Table 1 shows the results obtained for the effect of shear rate on the viscosity of untreated (2% C2) and treated (7% C2-5) chitin dissolved in 40% TCA/40% CH/20% MC. The table shows also similar results for 7% C2-6 dissolved in DMA/8% LiCl included for comparison. For each of the solutions, the viscosity was measured after a certain period of storage. This was done in order to compare the stability of the two chitin solutions. Figure 1 shows $\log \eta$ versus $\log D$ for these solutions and Fig. 2 shows the flow curves ($\log \tau$ versus $\log D$) for the solutions. It can be seen from the table and the figures that chitin generally degrades very rapidly in the acidic chlorinated solvent, and it does not appear to matter whether the samples are of high or low molecular weight. When compared with DMA-LiCl, the differences were enormous, for the solutions in DMA-LiCl were stable for the period examined. (Indeed the viscosity appeared to have increased slightly on standing (see section 3.2.1)). Therefore as far as solution stability was concerned, DMA-LiCl was a far better solvent. The inertness of this solvent to metals made it even more attractive for use in spinning fibres.

As was expected, the treated chitin samples exhibited almost Newtonian behaviour in both solvents, although the solution in the acidic chlorinated solvent was slightly more Newtonian. (Figure 1 compare curves 3 and 5) This could be ascribed to the lower viscosity of the solution in the chlorinated solvent. At a shear rate of 3.6 sec^{-1} the viscosity of the 7% treated chitin in DMA-LiCl (measured 24 hours after dissolution) was about a factor of five more than the similar

TABLE 1: Comparison of the viscosity of chitin solutions in DMA-LiCl and
40% TCA/40% CH/20% MC

Code	n	1	2	4	8	16	32	64	128	256	512
	D	0.9	1.8	3.6	7.1	14.2	28.5	57.0	113.9	227.8	455.7
	log D	-0.051	0.250	0.852	0.852	1.154	1.145	1.756	2.057	2.358	2.659
Chitin in 40% TCA/40% CH/20% MC											
(1) 2% solution (30 minutes after dissolution)											
C2	S	(1)	(2)	(4)	8	14	22	33	43	65	100
	τ	11.20	22.30	44.60	89.30	156.20	245.50	368.20	478.50	725.20	1115.70
	log τ	1.049	1.348	1.649	1.951	2.194	2.390	2.566	2.680	2.860	3.048
	η	12.50	12.50	12.50	12.50	11.00	8.60	6.50	4.20	3.20	2.40
	log η	1.098	1.098	1.098	1.098	1.041	0.934	0.813	0.623	0.505	0.380
(2) 2% solution (12 hours after dissolution)											
C2	S	(0)	(0)	(0)	(0)	(0)	(0)	(0)	(1)	(2)	5
	τ								11.2	22.3	55.80
	log τ								1.049	1.348	1.747
	η								0.10	0.10	0.10
	log η								-1.000	-1.000	-1.0
(3) 7% solution (3 hours after dissolution)											
C2-0.5	S	0	(1)	(3)	6	12	24	47	92	181	360
	τ		11.2	33.50	66.90	133.90	267.80	524.10	1026.40	2019.40	4016.50
	log τ		1.049	1.525	1.825	2.127	2.428	2.720	3.011	3.305	3.604
	η		6.20	9.30	9.30	9.40	9.40	9.20	9.00	8.90	8.80
	log η		0.792	0.968	0.968	0.973	0.973	0.964	0.954	0.949	0.944
(4) 7% solution (24 hours after dissolution)											
C2-0.5)	S	(0)	(0)	(0)	(0)	(1)	(2)	5	10	20	40
	τ					11.2	22.30	55.80	111.60	223.10	446.30
	log τ					1.049	1.348	1.747	2.048	2.348	2.650
	η					0.80	0.80	1.00	1.00	1.00	1.00
	log η					-0.097	-0.097	0.00	0.00	0.00	0.00
(5) 7% solution in DMA-8% LiCl (24 hours after dissolution)											
C2-6	S	(4)	8	16	31	57	106	196	362.0	676	1144
	τ	44.60	89.30	178.50	345.90	635.90	1182.60	2186.80	4038.80	7542.10	12763.60
	log τ	1.649	1.951	2.252	2.539	2.803	3.073	3.340	3.606	3.877	4.106
	η	49.60	49.60	49.60	48.70	44.80	41.50	38.40	35.50	33.10	28.00
	log η	1.695	1.695	1.695	1.688	1.651	1.618	1.584	1.550	1.520	1.447
(6) 7% solution in DMA-8% LiCl (2 months after dissolution)											
C2-6	S	5	10	19.5	35	62	115	201	368	680	1148
	τ	55.80	111.60	217.60	390.50	691.70	1283.0	2242.60	4105.80	7586.8	12808.2
	log τ	1.747	2.047	2.337	2.592	2.840	3.108	3.351	3.613	3.880	4.107
	η	62.0	62.0	60.40	55.0	48.70	45.00	39.30	36.00	33.30	28.10
	log η	1.792	1.792	1.781	1.740	1.688	1.653	1.595	1.556	1.522	1.449

TCA trichloroacetic acid
CH chloral hydrate
MC methylene chloride

FIG. 1: Comparison of the viscosity of chitin solutions in DMA-8% LiCl and in 40% TCA/40% CH/20% MC

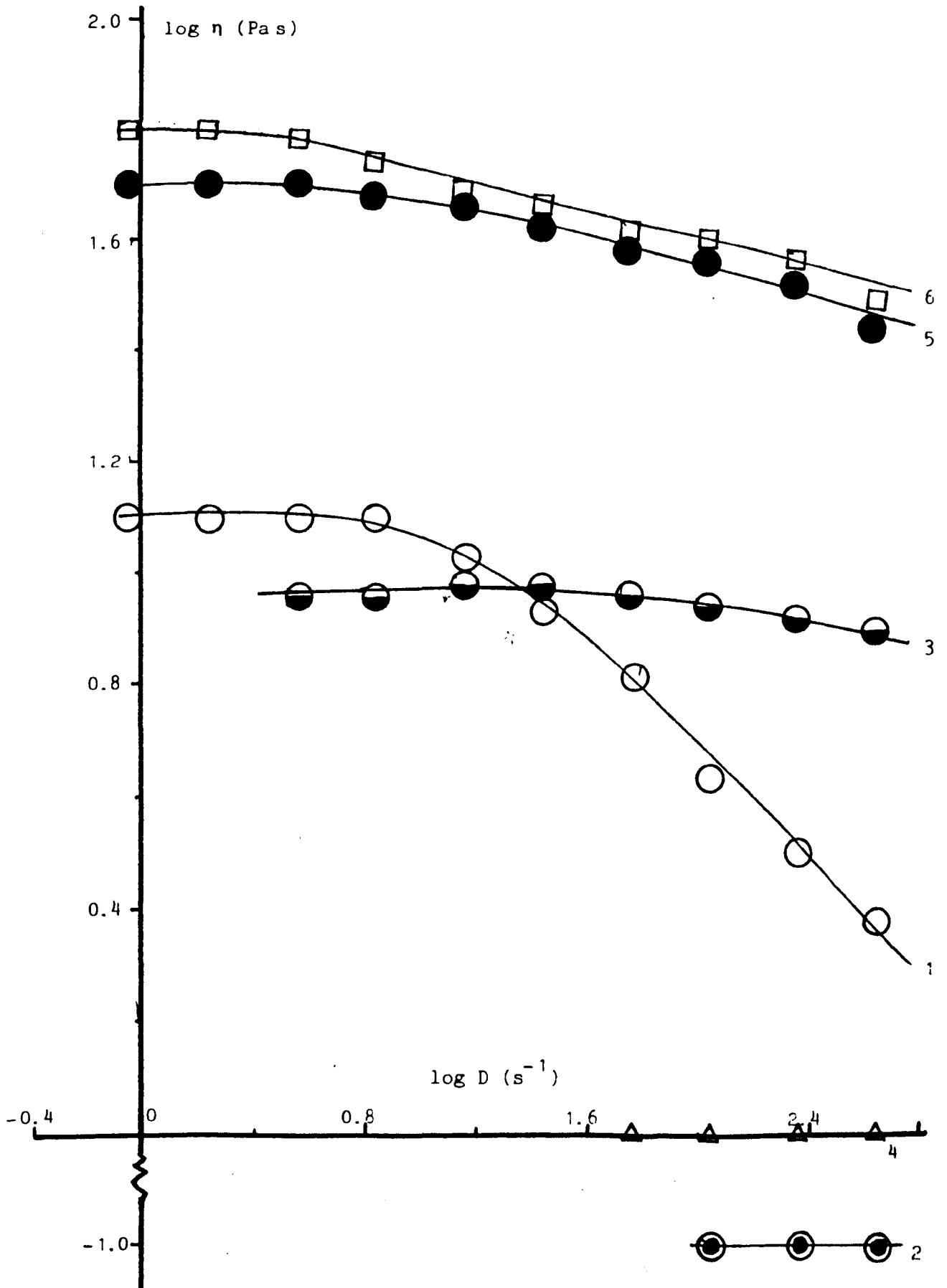
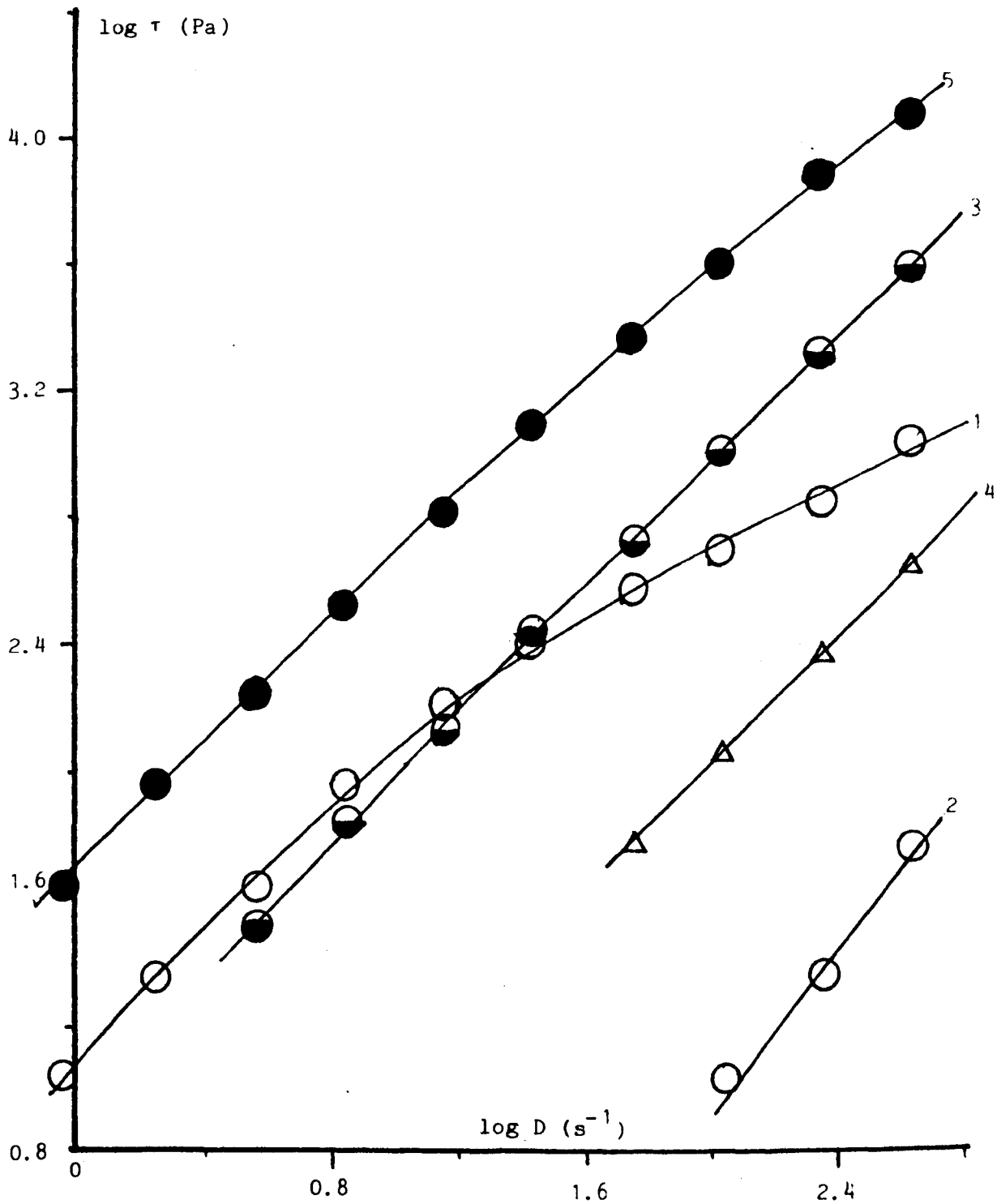

FIG. 2: Comparison of the flow curves of chitin solutions in DMA-LiCl and in 40% TCA/40% CH/20% MC

- (1) 2% solution (C2) in 40% TCA/40% CH/20%MC
30 min after dissolution
- (2) As in (1) but after 12 hours storage
- (3) 7% solution (C2-0.5)
in 40% TCA/40% CH/20% MC 3 hours after dissolution
- (4) As in (3) but after 24 hours storage
- (5) 7% solution (C2-6)
in DMA-8% LiCl after 24 hours storage



solution in the chlorinated solvent (measured 3 hours after dissolution). However, the acidic solvent was observed to be a more effective solvent than DMA-LiCl, in that the untreated chitin appeared to dissolve completely. In addition the solution showed Newtonian behaviour below about 7 sec^{-1} , although above this shear rate, the viscosity decreased quite rapidly with increasing shear rate. Also unlike DMA-LiCl, the shear stress did not appear to become almost constant (see Fig. 4.7 sample C2; 2% soln.) at high shear rates. This may be the result of the degradation which must have no doubt reduced the polymer molecular weight.

APPENDIX 2: Typical TGA curves of undrawn and drawn chitin fibres

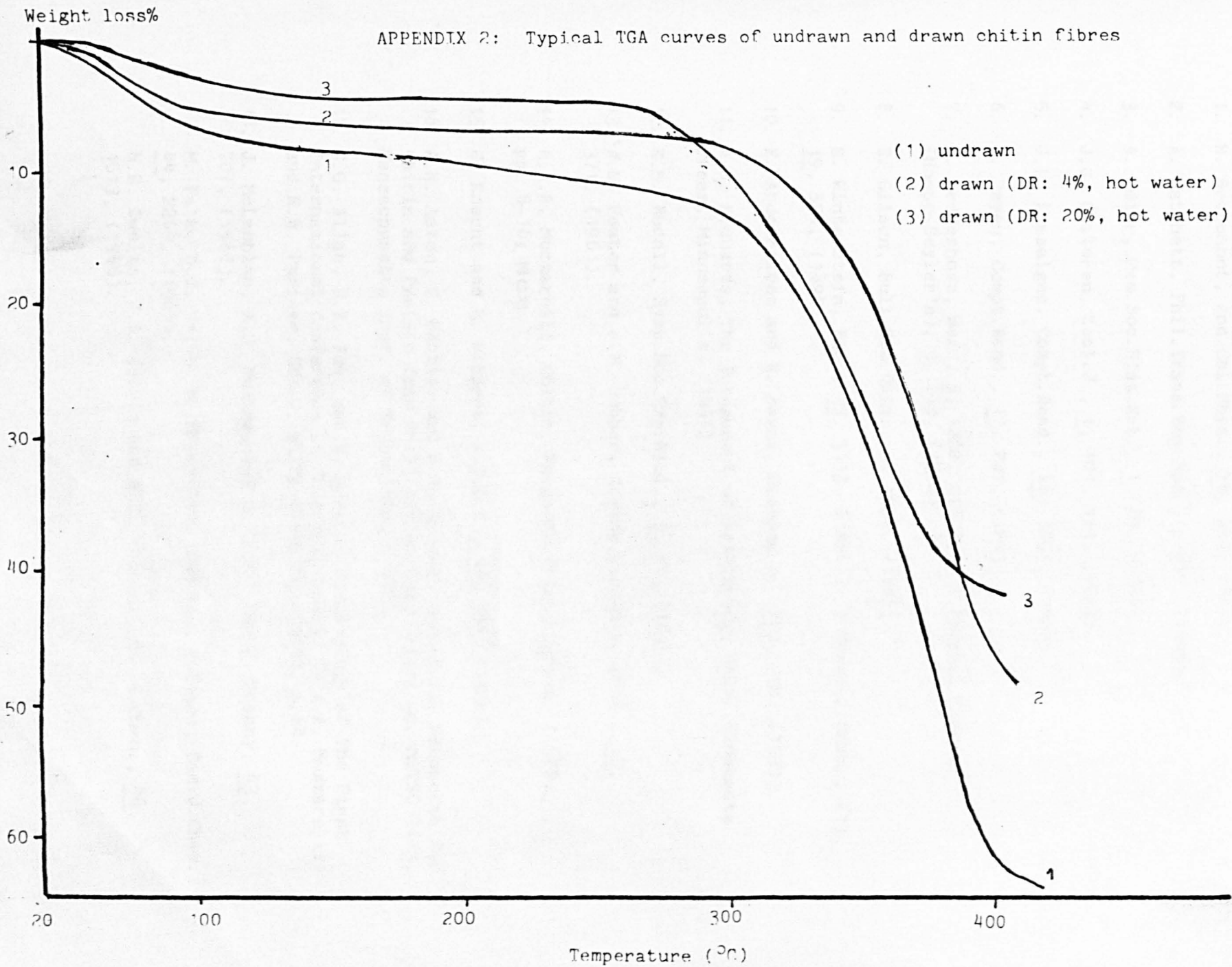

REFERENCES

1. H. Braconnot, *Ann.Chim.Phys.*, 79, 265, (1811).
2. A. Hatchett, *Phil.Trans.Roy.Soc.*, p.315, (1899).
3. A. Odier, *Mem.Soc.Hist.Nat.*, 1, 29, (1823).
4. J.G. Children, *Zool.J.*, 1, 101, 111, (1824).
5. J.L. Lassaigne, *Compt.Rend.*, 16, 1087, (1843).
6. A. Payen, *Compt.Rend.*, 17, 227, (1843).
7. G. Ledderhose, *Ber.*, 9, 1200, (1876); *Z.Physiol.Chem.*, (Hoppe-Seyler's), 2, 213, (1878).
8. E. Gilson, *Bull.Soc.Chim.*, 3, 1099, (1894).
9. E. Winterstein, *Ber.*, 27, 3113, (1894); *Z.Physiol.Chem.*, (1), 19, 521, (1894).
10. E. Abderhalden and K. Heyns, *Biochem.Z.*, 259, 320, (1933).
11. A.G. Richards, *The Integument of Arthropods*, Univ. Minnesota Press, Minneapolis, (1951).
12. K.M. Rudall, *Symp.Soc.Exp.Biol.*, 9, 49, (1955).
13. M.B. Foster and J.M. Webber, *Advanc.Carbohydr.Chem.*, 15, 371, (1961).
14. R.A.A. Muzzarelli, *Chitin*, Pergamon Press, Oxford, (1978), pp. 5-16; **208**
15. E. Knecht and E. Hibbert, *J.S.D.C.*, 42, 343, (1926).
16. A.N. Aston, D. Hattis, and E.A. Murray, *Industrial Prospects for Chitin and Protein from Shellfish Wastes*, Report No. MITSG 77-3, Massachusetts Inst. of Technology, (1976).
17. G.G. Allan, J.R. Fox, and N. Kong in *Proceedings of The First International Conference on Chitin/Chitosan*, (R.A.A. Muzzarelli and E.R. Pariser, Eds.), MITSG Program, (1978), p.64.
18. J. McLachlan, A.G. McInnes and M. Falk, *Can.J. Botany*, 43, 707, (1965).
M. Falk, D.G. Smith, M. McLachlan, and A.G. McInnes, *Can.J.Chem.*, 44, 2269, (1966).
N.E. Dweltz, J.R. Colvin and A.G. McInnes, *Can.J.Chem.*, 46, 1513, (1968).

19. A.E. Murray and D. Hattis, in Proceedings of The First International Conference on Chitin/Chitosan (edited by R.A.A. Muzzarelli and E.R. Pariser), MITSG Program, (1978), p.30.
20. R.L. Whistler and C.L. Smart, Polysaccharide Chemistry, (1953), p.395.
21. P.R. Austin, C.J. Brine, J.E. Castle and J.P. Zikakis, Science, 212, 749, (1981).
22. W.N. Haworth, W.H.G. Lake and S. Peat, J.Chem.Soc., 61, 271, (1939).
23. E.G. Cox and G.A. Jeffrey, Nature, 143, 894, (1939).
24. J.C. Irvine, J.Chem.Soc., 95, 564, (1909).
25. F. Tiemann, Ber., 19, 49, (1886).
26. E. Fischer and H. Leuchs, Ber., 36, 24, (1903).
27. R.H. Hackman, Aust.J.Biol.Sci., 7, 168, (1954).
28. P. Karrer and G. François, Helv.Chim.Acta, 12, 986, (1929).
29. R.H. Hackman, Aust.J.Biol.Sci., 15, 526, (1962).
30. S.A. Barker, A.B. Foster, M. Stacey and J.M. Webber, Chem. and Ind., 208, (1957); J.Chem.Soc., 2218, (1958).
31. C.H. Giles, A.S.A. Hassan, M. Laidlaw and R.V.R. Subramanian, J.S.D.C., 74, 647, (1958).
32. D.F. Waterhouse, R.H. Hackman, and J.W. McKellar, J.Insect Physiol., 6, 96, (1961).
33. K.M. Rudall, Adv.Insect Physiol, 1, 257, (1963).
34. M.A. Haleem, Ph.D. Thesis, (1971), Leeds University.
35. K.M. Rudall and W. Kenchington, Biol.Rev., 49, 597, (1973).
36. H.W. Gonell, Zeit.Physiol.Chem., 152, 18, (1926).
37. J. Blackwell, Ph.D. Thesis, (1967), Leeds University.
38. K.H. Meyer and G.W. Pankow, Helv.Chim.Acta, 18, 589, (1935).
39. G.L. Clark and A.F. Smith, J.Phys.Chem., 40, 863, (1936).
40. W. Lotmar and L.E.R. Picken, Experientia, 6, 58, (1950).

41. S.E. Darmon and K.M. Rudall, *Disc.Faraday Soc.*, 9, 251, (1950).
42. D. Carlstrom, *J.Biophys.Biochem.Cytol.*, 3, 669, (1957).
43. N.E. Dweltz, *Biochim.Biophys.Acta*, 44, 416, (1960).
44. J. Blackwell, R. Minke and K.H. Gardner in *Proceedings of The First International Conference on chitin/chitosan*, (R.A.A. Muzzarelli and E.R. Pariser, Eds.), MITSG Program, (1978), p.108.
45. P.H. Hermans, J. de Booy and C.J. Maan, *Kolloid-z*, 102, 169, (1943).
46. F.G. Pearson, R.H. Marchessault, and C.Y. Liang, *J.Polymer Sci.*, 43, 101, (1960); R.H. Marchessault, F.G. Pearson and C.Y. Liang, *Biochim.Biophys.Acta*, 45, 499, (1960).
47. R.A. Jacobson, J.A. Wunderlich and W.N. Lipscomb, *Acta Cryst.*, 14, 598, (1961).
48. D. Carlstrom, *Biochim.Biophys.Acta*, 59, 361, (1962).
49. M.A. Haleem and K.D. Parker, *Zeit.Naturforsch*, 31c, 383, (1976).
50. C. Ramakrishnan and N. Prasad, *Biochim.Biophys.Acta*, 261, 123, (1972).
51. R.H. Hackman and M. Goldberg, *J.Insect Physiol.*, 2, 221, (1958).
52. J. Blackwell and M.A. Weih in *Chitin, Chitosan and Related Enzymes*, (J.P. Zikakis, Ed.), Academic Press, London, (1984), p.257.
53. M. Attwood and H. Zola, *Comp.Biochem.Physiol.*, 20, 993, (1966).
54. P.R. Austin, C.J. Brine, J.E. Castle and J.P. Zikakis, *Science*, 212, 749, (1981).
55. R.A.A. Muzzarelli, *Chitin*, Pergamon Press, p.89, (1978).
56. G.D. Searles, Private communication.
57. F.A. Rutherford and P.R. Austin in *Proceedings of The First International Conference on chitin/chitosan*, (R.A.A. Muzzarelli and E.R. Pariser, Eds.), MITSG Program, (1978), p.182.
58. P. Karrer and A. Hoffman, *Helv.Chim.Acta*, 12, 616, (1929).
59. U.S.P. 3,879,377.
60. U.S.P. 3,847,897.

61. U.S.P. 4,286,087.
62. U.S.P. 4,059,457.
63. J.R. Deschamps and J.E. Castle in Chitin and Chitosan, (S. Hirano and S. Tokura, Eds.), Japanese Society of Chitin and Chitosan, (1982), p.63.
64. R.A.A. Muzzarelli, Carbohydrate Polymers, 3, 53, (1983).
65. R. Highfield, The Guardian, Thurs. Dec. 27, p.12, (1984).
66. E.S. Edgar, Manufacturing Chemist, 55, 73, (1984).
67. N. Nishi, H. Ohnuma, S. Nishimura, O. Somorin and S. Tokura, Polym.J., 14, 919, (1982).
68. B. Davis and D.E. Eveleigh in "Chitin, Chitosan and Related Enzymes" (J.P. Zakakis, Ed.), Academic Press, London, (1984), p.162.
69. U.S.P. 2,040,879.
70. C.V. Lusean and R.C. Rose, J.Fish.Res.Board Can., 10, 521, (1953).
71. T. Sannan, K. Kurita and Y. Iwakura, Makromol.Chem., 177, 3589, (1976).
72. A. Domard and M. Rinaudo, Int.J.Biol.Macromol., 5, 49, (1983).
73. R.A.A. Muzzarelli, Chitin, Pergamon Press, Oxford, (1978), p.94.
74. L.J. Filar and M.G. Wirick in Proceedings of The First International Conference on chitin/chitosan, (R.A.A. Muzzarelli and E.R. Pariser, Eds.), MITSG Program, (1978), pp.171-172.
75. N. Nishi, J. Noguchi, S. Tokura and H. Shiota, Polym.J., 11, 27, (1979).
76. K. Kaifu, N. Nishi and T. Komai, J.Polym.Sci., (Polym.Chem.Ed.), 19, 2361, (1981).
77. O. Somorin, N. Nishi, S. Tokura and J. Noguchi, Polym.J., 11, 391, (1979).
78. K. Kaifu, N. Nishi, T. Komai, S. Tokura and O. Somorin, Polym. Sci.J., 13, 241, (1981).
79. V.F. Lee, Univ.Microfilms, Ann Arbor, 74/29,446.
80. K. Shimahara, Y. Takiguchi, K. Ohkouchi, K. Kitamura and O. Okada in Chitin, Chitosan and Related Enzymes, (J.P. Zikakis, Ed.), Academic Press, Oxford, (1984), p.239.

81. G. Kunike, J.S.D.C., 42, 318, (1926).
82. E. Knecht and E. Hibbert, J.S.D.C, 42, 343, (1926).
83. U.S.P. 2,168,374 and 2,168,375.
84. C.J.B. Thor and W.F. Henderson, Am.Dyestuff Rep., 29, 461, (1940).
85. C.J.B. Thor and W.F. Henderson, Am.Dyestuff Rep., 29, 489, (1940).
86. L.L. Balassa and J.F. Prudden in Proceedings of the First International Conference on Chitin/Chitosan, (R.A.A. Muzzarelli and E.R. Pariser, Eds.), MITSG Program (1978), p.298.
87. U.S.P. 3,914,413.
88. U.S.P. 3,632,754.
89. U.S.P. 3,911,116.
90. J. Noguchi, S. Tokura and N. Nishi in Proceedings of the First International Conference on Chitin/Chitosan, (R.A.A. Muzzarelli and E.R. Pariser, Eds.), MITSG Program, (1978), p.315.
91. U.S.P. 3,892,731.
92. U.S.P. 4,029,727.
93. S. Tokura, N. Nishi and J. Noguchi, Polym.J., 11, 781, (1979).
94. U.S.P. 3,988,411.
95. B.P. 1,511,219.
96. M. Nakajima, K. Atsumi and K. Kifune, in Chitin, Chitosan and Related Enzymes, (J.P. Zikakis, Ed.), Academic Press, Oxford, (1984), p.407.
97. U.S.P. 4,431,601 and E.P. 0 0051 421 A1.
98. S. Tokura, N. Nishi, O. Somorin and J. Noguchi, Polym.J., 12, 695, (1980).
99. S. Tokura, J. Yoshida, N. Nishi and T. Hiraoki, Polym. J., 14, 527, (1982).
100. S. Tokura, N. Nishi, S. Nishimura and O. Somorin, Sen-i Gakkaishi, 39, (No.12), T-507, (1983).
101. A. Blumstein (Ed.), Liquid Crystalline Order in Polymers, Academic Press, (1978).

102. P. Navard and J.M. Haudin, *British Polym.J.*, p.174, (Dec. 1980).
103. R.H. Marchessault, F.F. Morehead and N.M. Walter, *Nature*, 184, 632, (1959).
104. H. Chanzy, A. Peguy, S. Chaunis, and P. Monzie, *J.Polym.Sci., Polym.Phys.Ed.*, 18, 1137, (1980).
105. R.N. Armstrong, J.K. Varga and C.C. McCorsley, III, American Enka Company, Enka, NC. 28728.
106. E.P. 0103 398 A2.
107. M. Huggins, *J.Am.Chem.Soc.*, 64, 2716, (1942).
108. P.J. Flory, *J.Am.Chem.Soc.*, 65, 372, (1943).
109. M. Miya, R. Iwamoto, S. Yoshikawa and S. Mima, *Int.J.Biol. Macromol.*, 2, 323, (1980).
110. T. Sannan, K. Kurita, K. Ogura and Y. Iwakura, *Polym.*, 19, 458, (1978).
111. C.K. Kandaswamy in *Proceedings of The First Int.Conf. on Chitin/Chitosan*, (R.A.A. Muzzarelli and E.R. Pariser, Eds.), MITSG Program, (1978), p.406.
112. G.K. Moore and G.A.F. Robberts in *Proceedings of the First Int. Conf. on Chitin/Chitosan*, (R.A.A. Muzzarelli and E.R. Pariser, Eds.), MITSG Program, (1978), p.421.
113. P. Nourpanah, Ph.D. Thesis, (1982), Leeds University.
114. G.C. Patel, M.Sc. Thesis, (1979), Leeds University.
115. C.L. McCormick and T.S. Shen in *Macromolecular Solutions, Solvent Properties Relationships in Polymers*, (R.B. Seymour and G.A. Stahl, Eds.), (1982), p.101.
116. J.E. Castle, J.R. Deschamps and K. Tice in *Chitin, Chitosan and Related Enzymes*, (J.P. Zikakis, Ed.), Academic Press, Oxford, (1984), p.273.
117. J.P. Knudsen, *Text.Res.J.*, 33, 13, (1963).
118. D.R. Paul, *J.Appl.Polym.Sci.*, 12, 383, (1968).
119. J.P. Bell and J.H. Dumbleton, *Text.Res.J.*, 41, 196, (1971).
120. J.P. Craig, J.P. Knudsen and V.F. Holland, *Text.Res.J.*, 32, 435, (1962).

121. A. Ziabicki, *Fundamentals of Fibre Formation*, Wiley-Intersci., London, (1976), p.344.
122. U.S.P. 3,080,210.
123. U.S.P. 3,701,820.
124. U.S.P. 3,079,219.
125. B.P. 1,423,441.
126. B.P. 1,106,190.
127. U.S.P. 30,352.
128. T.A. Hancock, J.E. Spruiell and J.L. White, *J. Appl. Polym. Sci.*, 21, 1227, (1977).
129. U.S.P. 4,302,252.
130. W.F. Linke, *Solubilities of Inorganic and Metal Organic Compounds*, (K-Z), 4th Ed., Am. Chem. Soc., (1965), pp.390-407.
131. J.B. Speakman and N.H. Chamberlain, *J.S.D.C.*, 60, 264, (1944).
132. Tang, M.Sc. Dissertation, (1983), Leeds University.
133. D.R. Paul and A.L. McPeters, *J. Appl. Polym. Sci.*, 21, 1699, (1977).
134. A.M.R. Mwakatole, M.Sc. Dissertation, (1982), Leeds University.
135. R.H. Hackman and M. Goldberg, *Carbohydr. Res.*, 38, 35, (1974).
136. R.A.A. Muzzarelli, *Chitin*, Pergamon Press, Oxford, (1978), p.89.
137. J.A. Brydson, *Flow Properties of Polymer Melts*, George Godwin Ltd., (2nd Ed., 1981), p.9.
138. H.P. Schreiber, E.B. Bagley and D.C. West, *Polym.*, 4, 355, (1963).
139. J.E. Guillet, R.L. Combs, D.F. Slonaker, D.A. Weemes and H.W. Coover, Jr., *J. Appl. Polym. Sci.*, 8, 757, (1965).
140. R.S. Porter and J.F. Johnson, *J. Polym. Sci.*, L, 379, (1961).
141. W.F. Busse and R. Longworth, *J. Polym. Sci.*, 58, 49, (1962).
142. J.G. Tomka, Private communication.
143. A. Ziabicki, *Fundamentals of Fibre Formation*, Wiley-Interscience, London, (1976), p.27.

144. T.G. Fox, S. Gratch and S. Loshaek in *Rheology, Theory and Applications*, Vol. 1, (F.R. Eirich, Ed.), Acad. Press, N.York, (1956), Chap. 12, pp.442-446.
145. T.G. Fox and S. Loshaek, *J.Biol.Phys.*, 26, 1080, (1955).
146. E.B. Bagley and D.C. West, *J.Appl.Phys.*, 29, 1511, (1958).
147. H.B. Schreiber, *Polym.*, 4, 365, (1963).
148. T. Kataoka and S. Ueda, *J.Polym.Sci.*, (A-1), 5, 3071, (1967).
149. G.V. Vinogradov and A. Ya Malkin, *Rheology of Polymers*, Mir Publishers, Moscow, (1980), p.158.
150. F. Bueche, *J.Appl.Phys.*, 26, 738, (1955).
151. S.N. Chinai and W.C. Schneider, *J.Polym.Sci.*, (Part A), 3, 1359, (1965).
152. F. Bueche, *J.Polym.Sci.*, XLIII, 527, (1960).
153. L.D. Moore, Jr., *J.Polym.Sci.*, XXXVI, 155, (1959).
154. R.A. Mendelson, in *Encyclopaedia of Polym. Sci. and Techn.*, (H.F. Mark, N.G. Gaylord and N.M. Bikales, Eds.), Wiley-Interscience, New York, 8, 587, (1968).
155. M.F. Johnson, W.W. Evans, I. Jordan and J.D. Ferry, *J.Colloid Sci.*, 7, 498, (1952).
156. J.D. Ferry, L.D. Grandine, Jr., and D.C. Udy, *J.Colloid Sci.*, 8, 529, (1953).
157. Y. Oyanagi and M. Matsumoto, *J.Colloid Sci.*, 17, 426, (1962).
158. S. Onogi, T. Kobayashi, Y. Kojima and Y. Taniguchi, *J.Appl.Polym. Sci.*, 7, 847, (1963).
159. H. Elias, *Macromolecules*, Plenum Press, London, (1977), 1, 271, (1977).
160. R.F. Landel, J.W. Berge and J.D. Ferry, *J.Colloid Sci.*, 12, 400, (1957).
161. G.V. Vinogradov and A. Ya Malkin, *Rheology of Polymers*, Mir Publishers, Moscow, (1980), p.119.
162. D.R. Paul, *J.Appl.Polym.Sci.*, 12, 383, (1968).
163. H. Strathmann and K. Kock, *J.Desalination*, 21, 241, (1977).

164. I. Cabasso, *Desalination*, 1, 267, (1981), (from ACS Symp. series, No. 153 on Synthetic Membranes).
165. H. Strathmann, P. Scheible and R.W. Baker, *J. Appl. Polym. Sci.*, 15, 811, (1971).
166. A. Ziabicki, *Fundamentals of Fibre Formation*, Wiley-Interscience, London, (1976), p.298.
167. M. Takahashi, Y. Nukushina and S. Kosugi, *Text. Res. J.*, 34, 87, (1964).
168. A. Ziabicki, *Fundamentals of Fibre Formation*, Wiley-Interscience, London, (1976), p.301.
169. V. Grobe and H.J. Heyer, *Faserforschung u. Textiltech.*, 19, 398, (1968).
170. J.G. Wijmans, J. Kant, M.H.V. Mulder and C.A. Smolders, *Polym.*, 26, 1539, (1985).
171. J.R. Booth, *App. Polym. Symp.*, 6, 89, (1967).
172. A. Ziabicki, *Fundamentals of Fibre Formation*, Wiley-Interscience, London, (1976), pp.310-326.
173. J.C. Brown, *J.S.D.C.*, 75, 11, (1959).
174. P.H. Hobson and A.L. McPeters, *Encyclopedia of Chem. Techn.*, 3rd Ed., (K. Othmer, Ed.), Wiley-Interscience, N. York, 1, 355, (1978).
175. R.W. Moncrieff, *Man Made Fibres*, 5th Ed., Heywood Books, (1970), p.270.
176. M.E. Epstein and A.J. Rosenthal, *Text. Res. J.*, 36, 813, (1966).
177. B.R. Roberts in *Rheology*, Vol. 3, (E. Eirich Ed.), Academic Press, (1960), p.553.
178. M. Vincendon, *Die Makromol. Chem.* in press, (1985).
179. M. Vincendon, 3rd Chitin Conf., ANCONA, (1985).
180. J. Saint-Germain and M. Vincendon, *Makromol. Chem.*, 183, 593, (1982).
181. J. Saint-Germain and M. Vincendon, *Org. Magn. Res.*, 21, 371, (1983).
182. S. Akbari, M.Sc. Thesis, (1985), Leeds University.
183. D.C. Hockway, *J. Text. Inst.*, 49, 292, (1958).

184. W.H. Gloor, *Appl. Polym. Symp.*, 6, 151, (1967).
185. H. Ludwig, *Polyester Fibres Chemistry and Technology*, Wiley Interscience, London, (1971), pp.223-271.
186. U.S.P. 3,049,518.
187. I. Marshall and A.B. Thompson, *J. Appl. Chem.*, 4, 145, (1954).
A. Judge and D.E. Montgomery, *Appl. Polym. Symp.*, 21, 43, (1973).
188. U.S.P. 3,360,598.
189. P.R. Blakey, D.E. Montgomery and H.M. Sumner, *J. Text. Inst.*, 61, 234, (1970).
190. M. Takahashi and M. Watanabe, *J. Soc. Textile Cellulose Ind. Japan*, 15, 951, (1959).
191. U.S.P. 3,608,043; B.P. 1,191,569.
192. A. Takizawa, *Sen-i-Gakkaishi*, 17, 390, (1961).
193. R.W. Moncrieff, *Man Made Fibres*, 5th Ed., Heywood Books, (1970), p.126.
194. R.L. Mitchell and G.C. Daul in *Encyclopedia of Polym. Sci. and Techn.*, 11, 810, (1969).
195. E.E. Tallis, *J. Text. Inst.*, 41, 52, (1950).
196. H. Moussavi Pour, Private communication.
197. U.S.P. 888,496.
198. U.S.P. 977,942.
199. K.M. Paralikar and R.H. Balasubramanya, *J. Polym. Sci: Polym., Letters Ed.*, 22, 543, (1984).
200. A. N. Adio-Moses, M.Phil. Thesis, (1975), Leeds University.
201. A. Ziabicki, *Fundamentals of Fibre Formation*, Wiley-Interscience, London, (1976), p.397.
202. J.E. McIntyre, Private communication.
203. D.N. Buttrey, *Plasticizer*, 2nd Ed., Cleaver-Hume Press, London, (1957), p.9.
204. I. Mellan, *The Behavior of Plasticizers*, Pergamon Press, London, (1961), part II, pp.63-151.

205. G.C. East, Private communication.
206. G.V. Schultz and M. Marx, Makromol.Chem., 14, 52, (1954); J.Polym.Sci., 30, 119, (1958).
207. O.A. Battista, Encyclopedia of Polym.Sci. and Techn., (H.F. Mark, N.G. Gaylord and N.M. Nikales, Eds.), Wiley-Interscience, N.York, 3, 285, (1965).
208. P. Ovitigala, Ph.D. Thesis, (1979), Leeds University.
209. I. Marshall and J.R. Whinfield in Fibres From Synthetic Polymers, (R. Hill Ed.), Elsevier Publishing Company, London, (1953), p.348.
210. J.J. Press, J.Appl.Phys., 14, 224, (1943); H. Mark and J.J. Press, Rayon Textile Monthly, 24, 297, 339, 405, (1943).
211. R. Meredith, J.Text.Inst., 37, 469, (1946).