

Economic-Epidemiological Analysis of Tuberculosis

Modelling the Demographic-Epidemiological Implications

of Economic Growth and Public Health Investment

Thesis submitted for the degree of Doctor of Philosophy

by

Doriana Delfino

Department of Economics and Related Studies  
University of York

September 2001

## Abstract

Infectious diseases have long been identified as a main cause of mortality in human population. Tuberculosis (TB) has always been a serious public health threat both in developing and developed countries. In this work we argue that relying exclusively on the current targeted bio-medical strategy is an inadequate approach to the lasting control of TB. Diseases such as TB are a reflection of underlying social conditions of inequity and poverty. A more complex and interdisciplinary model integrating the contributing factors for the TB epidemic is needed.

The first purpose of the present work is to sharpen the understanding of the dynamics of the two way interaction between the economy and TB. This, in turn, allows us to analyse the interplay between the determinants of the TB epidemiological dynamics and the variables which drive the economic process. Specifically, we model this two-way interaction between the economy and the infection process by integrating a predator-prey Lotka-Volterra type model with the one-sector Solow-Swan (1956) economic growth model. The new system is defined as the *economic-epidemiological growth system*. We divide the population into susceptible and TB infected/infectious individuals and analyse their dynamic interactions where infected people behave as predators of susceptible preys. In different parts of the work we allow for TB infected individuals to receive effective treatment and to be cured. Under the assumption that only susceptible individuals are productive, variations in labour force participation are assumed to be a function of TB prevalence for involuntary reasons. To analyse the economic-epidemiological interaction between the economic system and the disease we consider the demographic-epidemiological factors to be functions of economic variables. In particular, we have organised our analysis by laying out two main scenarios of the interdependency between the TB infectious disease and the economic system. At first we consider an economic-epidemiological growth model with productive capacity a function of human inputs and capital per healthy worker where TB epidemics affect the quality of the population and hence the productivity of the economic system. Subsequently, demographic-epidemiological parameters are taken as a function of public health investment as improvements in the basic health infrastructure (e.g. hospitals, medical equipment, transport and supplies) are believed to favour the decline of TB morbidity/mortality rates and hence reduce the source of new TB infections. Furthermore, we consider the case of a central planner who determines savings so that social welfare, as a function of the accumulation of productive capital/public health investment and of the level of TB prevalence, is maximised. We present analytic results followed by results from a calibrated version of the model using realistic estimates of the demographic, epidemiological and economic parameters. We use a variety of data sets from the World Bank and World Health Organization sources.



*"The enjoyment of the highest attainable standard of health  
is one the fundamental rights of every human being."*

- Preamble to the World Health Organization Constitution UN 1948 -

*A mia nonna Gege*

## Acknowledgments

I owe the University of York a debt of gratitude for the offer of a three year Fellowship which allowed me to undertake my DPhil course.

I would like to thank Prof. Peter Simmons, Prof. Charles Perrings and Dr. Tim Ensor for their precious and stimulating supervision. A special thank you goes to Prof. Peter Simmons for his patient support and the long discussions in his office always rich of advice, suggestions and new ideas.

I would like to thank my parents, my brother Donald, my grandmother and all my valued friends to whom my deepest gratitude will never be enough.

## Declaration

Chapter 3 is a development of collaborative theoretical work with Prof. Peter Simmons; an earlier version of which was presented at the Royal Economic Society Conference at St. Andrews (UK), 2000.

Chapter 4 is based on collaborative work with Prof. Peter Simmons; an earlier version of which was presented at the Royal Economic Society Conference at Durham (UK), 2001



# Contents

<b>1</b>	<b>Introduction</b>	<b>9</b>
<b>2</b>	<b>Critical Literature Review</b>	<b>23</b>
2.1	The Theory of Nonlinear Dynamical Systems: Stability Analysis	23
2.2	Epidemiological Literature View of Infectious Diseases: the Case of Tuberculosis . . . . .	29
2.2.1	Clinical and Pathological Course of Tuberculosis . . . . .	30
2.2.2	Definition and Basic Concepts in Epidemiology . . . . .	41
2.2.3	The Basic Epidemiological Model: the Predator-Prey Lotka-Volterra Model . . . . .	43
2.2.4	The Interpersonal Contact Rate and the TB Transmis- sion Coefficient . . . . .	46
2.2.5	The Incubation Period . . . . .	48
2.2.6	The Recovered Class . . . . .	55
2.3	Economic Growth Theory . . . . .	58
2.4	Summary . . . . .	72
<b>3</b>	<b>Prototype Model</b>	<b>74</b>
3.1	Demographic-Epidemiological Model . . . . .	75
3.1.1	Calibration . . . . .	81
3.2	Economic-Epidemiological Model . . . . .	85
3.2.1	Calibration . . . . .	100
3.3	Summary . . . . .	106
<b>4</b>	<b>Descriptive and Optimal Control Analysis of a Productive Capital Model</b>	<b>108</b>
4.1	Descriptive Analysis: Demographic - Epidemiological Model .	109
4.1.1	Calibration . . . . .	112
4.2	Descriptive Analysis: Economic-Epidemiological Model . . . . .	114
4.2.1	Calibration . . . . .	122
4.3	Optimal Control Analysis . . . . .	125

4.3.1	Necessary Conditions for Optimality . . . . .	127
4.3.2	Dynamic Analysis . . . . .	131
4.3.3	Calibration . . . . .	138
4.3.4	Sufficient Conditions for Optimality . . . . .	141
4.4	Summary . . . . .	151
<b>5</b>	<b>Descriptive and Optimal Control Analysis of a Public Health Investment Model with and without Recovery</b>	<b>154</b>
5.1	Descriptive Analysis: Demographic - Epidemiological Model .	155
5.1.1	Calibration . . . . .	161
5.2	Descriptive Analysis: Economic-Epidemiological Model with Recovery . . . . .	164
5.2.1	Calibration . . . . .	168
5.3	Descriptive Analysis: Economic-Epidemiological Model without Recovery . . . . .	172
5.3.1	Calibration . . . . .	176
5.4	Optimal Control Analysis . . . . .	183
5.4.1	Necessary Conditions for Optimality . . . . .	183
5.4.2	Dynamic Analysis . . . . .	186
5.4.3	Calibration . . . . .	188
5.4.4	Sufficient Conditions for Optimality . . . . .	190
5.5	Summary . . . . .	198
<b>6</b>	<b>Conclusions</b>	<b>201</b>
<b>A</b>	<b>Appendix</b>	<b>207</b>
A.1	Linearization around the First Stationary Point in the Economic-Epidemiological Prototype Model . . . . .	207
A.2	Linearization around the Third Stationary Point in the Economic-Epidemiological Prototype Model . . . . .	209
A.3	The Jacobian for the Centrally Planned Productive Model . .	210

A.4	Sufficiency of the Necessary Conditions for Optimality with Exogenous Growth in Prevalence . . . . .	215
A.5	The Jacobian for the Centrally Planned Public Health Investment Model with Recovery . . . . .	216

# Contents

<b>1</b>	<b>Introduction</b>	<b>9</b>
<b>2</b>	<b>Critical Literature Review</b>	<b>23</b>
2.1	The Theory of Nonlinear Dynamical Systems: Stability Analysis	23
2.2	Epidemiological Literature View of Infectious Diseases: the Case of Tuberculosis . . . . .	29
2.2.1	Clinical and Pathological Course of Tuberculosis . . . . .	30
2.2.2	Definition and Basic Concepts in Epidemiology . . . . .	41
2.2.3	The Basic Epidemiological Model: the Predator-Prey Lotka-Volterra Model . . . . .	43
2.2.4	The Interpersonal Contact Rate and the TB Transmis- sion Coefficient . . . . .	46
2.2.5	The Incubation Period . . . . .	48
2.2.6	The Recovered Class . . . . .	55
2.3	Economic Growth Theory . . . . .	58
2.4	Summary . . . . .	72
<b>3</b>	<b>Prototype Model</b>	<b>74</b>
3.1	Demographic-Epidemiological Model . . . . .	75
3.1.1	Calibration . . . . .	81
3.2	Economic-Epidemiological Model . . . . .	85
3.2.1	Calibration . . . . .	100
3.3	Summary . . . . .	106
<b>4</b>	<b>Descriptive and Optimal Control Analysis of a Productive Capital Model</b>	<b>108</b>
4.1	Descriptive Analysis: Demographic - Epidemiological Model .	109
4.1.1	Calibration . . . . .	112
4.2	Descriptive Analysis: Economic-Epidemiological Model . . . . .	114
4.2.1	Calibration . . . . .	122
4.3	Optimal Control Analysis . . . . .	125



4.3.1	Necessary Conditions for Optimality . . . . .	127
4.3.2	Dynamic Analysis . . . . .	131
4.3.3	Calibration . . . . .	138
4.3.4	Sufficient Conditions for Optimality . . . . .	141
4.4	Summary . . . . .	151
<b>5</b>	<b>Descriptive and Optimal Control Analysis of a Public Health Investment Model with and without Recovery</b>	<b>154</b>
5.1	Descriptive Analysis: Demographic - Epidemiological Model .	155
5.1.1	Calibration . . . . .	161
5.2	Descriptive Analysis: Economic-Epidemiological Model with Recovery . . . . .	164
5.2.1	Calibration . . . . .	168
5.3	Descriptive Analysis: Economic-Epidemiological Model with- out Recovery . . . . .	172
5.3.1	Calibration . . . . .	176
5.4	Optimal Control Analysis . . . . .	183
5.4.1	Necessary Conditions for Optimality . . . . .	183
5.4.2	Dynamic Analysis . . . . .	186
5.4.3	Calibration . . . . .	188
5.4.4	Sufficient Conditions for Optimality . . . . .	190
5.5	Summary . . . . .	198
<b>6</b>	<b>Conclusions</b>	<b>201</b>
<b>A</b>	<b>Appendix</b>	<b>207</b>
A.1	Linearization around the First Stationary Point in the Economic-Epidemiological Prototype Model . . . . .	207
A.2	Linearization around the Third Stationary Point in the Economic-Epidemiological Prototype Model . . . . .	209
A.3	The Jacobian for the Centrally Planned Productive Model . .	210

A.4	Sufficiency of the Necessary Conditions for Optimality with Exogenous Growth in Prevalence . . . . .	215
A.5	The Jacobian for the Centrally Planned Public Health Investment Model with Recovery . . . . .	216

**PAGE  
NUMBERING  
AS ORIGINAL**

# 1 Introduction

Infectious diseases have long been identified as a main cause of mortality in human population. Despite improvements in medical knowledge, sanitation, personal hygiene, diet and health education, disease-causing micro-organisms are reappearing throughout the world.<sup>1</sup> Some are newly identified, such as HIV/AIDS, Hanta Virus, Lassa Fever and Ebola; many are diseases, which were thought to be well controlled (such as tuberculosis, malaria, plague and measles) often also emerging in more virulent forms such as certain drug-resistant strains of bacteria (the emergence of a multidrug-resistant tuberculosis epidemic: MDR-TB). Tuberculosis (TB) has always been a serious public health threat both in developing and developed countries. During the 19th century and most of the first half of the 20th century TB, 'the white plague', was the main cause of death throughout the World.<sup>2</sup> As general population's living-working conditions improved, TB morbidity and mortality declined.<sup>3</sup> In Great Britain, mortality from TB began to fall between the 1830s and the 1880s and in the US that decline started in the 1860s-1870s. Local studies of TB mortality support the role of general prosperity reforms affecting nutrition and poverty in controlling TB<sup>4</sup>. However, historical studies also support the hypothesis that public health interventions, including housing policies, public education, improvements in infrastructures and sanitation leading to behavioural changes had an impact on the falling rates of mortality from TB infectious disease starting in the late 19th century.<sup>5</sup>

By the beginning of the 1970s TB was no longer a significant health

---

<sup>1</sup>Worldwide, infectious diseases killed more than 16.5 million people in 1999. By comparison, the death toll from cancer was 6.1 million, from cardiovascular diseases 9.7 million and from cerebrovascular diseases, such as stroke, 4 million. Plant and Rushworth, 1997; WHO, 2000d.

<sup>2</sup>Bates, 1992; Dubos and Dubos, 1987.

<sup>3</sup>McKeown and Record, 1962.

<sup>4</sup>Curtin, 1989; Farmer, 1996; Fineberg and Wilson, 1996; Freudengerg, 1995; Frieden, 1994; Guha, 1993; Lerner, 1993; Sommer, 1995.

<sup>5</sup>Cronje', 1984; Hardy, 1993; McFarlane, 1989.



problem for the developed countries. However, from 1985 TB became the leading cause of morbidity and mortality in developing countries<sup>6</sup> and of increasing morbidity in areas of poverty in developed and the former socialist countries.<sup>7</sup> Deaths from TB in Russia have risen to the level they were 20 years ago and TB is rising in many large cities in western Europe such as London where it strongly correlates with indices of deprivation.<sup>8</sup>

There are three main factors that have led to the recent TB epidemic in many developing countries: the spread of HIV/AIDS infection, the increasing movements of people across countries and poverty, malnutrition, overcrowded housing together with poor hygienic conditions associated with rapidly increasing urbanization.<sup>9</sup> Reversion in the receding TB trend stimulated consideration of targeted bio-medical policies<sup>10</sup> based on isolation and antituberculosis drugs.<sup>11</sup> First established in Germany (Silesia) in the mid-19th century, the primary treatment for TB was to seclude and cure TB infected patient through the agency of fresh air and exercise, diet and graduated labour. Isolation of active cases of TB was meant to reduce the incidence of secondary attacks on those living in close proximity to the infected individual. Over time, isolation reduced the prevalence of the disease and subsequently TB incidence and mortality rates in the population as a whole. Segregation of individuals suffering from TB, by diminishing the transmission of infection, was found responsible for the decline in TB mortality in England and Wales, Scotland, Prussia and New York City.<sup>12</sup> The proportion

---

<sup>6</sup>Raviglione and Luelmo, 1996.

<sup>7</sup>Bhatti et al., 1995; Elender et al., 1998; Frieden et al., 1995; Raviglione and Luelmo, 1996.

<sup>8</sup>Bardsley et al., 1998; Hayward, 1998; McKee and Jacobson, 2000.

<sup>9</sup>Dievler and Pappas, 1999; Ginsberg, 1998; Jaramillo, 1999; Young et al. 1997.

<sup>10</sup>Use of targets as a tool in health policy was pioneered by McGinnis (1980) who brought the "management by objectives" approach into the health sector so that health systems could be evaluated in terms of output. The use of health targets at the beginning of the 1980s was also possible due to advances in the use of epidemiology for public health purposes.

<sup>11</sup>Bayer and Wilkinson, 1995.

<sup>12</sup>Wilson, 1990.

of segregated patients to the total number of patients corresponded closely to the proportional rate of decline in TB mortality.<sup>13</sup> In the 20th century, sanatoriums included clinical interventions such as tuberculin treatment and pneumothorax.<sup>14</sup> However, the role of segregation was controversial. Two dimensions of residential segregation have immediate epidemiological significance: the isolation and the concentration. The isolation of a given sub-group limited contact with the rest of the population and reduced the probability of transmission between the segregated group and the rest. When the isolated group experienced high concentration, the probability of transmission within this group was higher. In an exhaustive study about the relationship between the political economy of capitalist development and the epidemiology of TB in South Africa during the 20th century, Packard (1989) showed that segregation influenced TB rates through the deterioration of housing conditions for the segregated group. Black people were removed from urban areas and forced to live in so-called native locations. Insanitary and crowded living conditions in both slums and native locations fostered TB transmission among Africans. Additionally, because of the policy of not allowing the permanent settlement of Africans in employment centres, TB spread also to rural areas from which workers were recruited.

The advent of antituberculosis drugs altered the treatment of TB. The currently international targeted strategy for controlling TB is Directly Observed Therapy with Short-course chemotherapy (DOTS). DOTS<sup>15</sup> is a labour intensive but low-technology strategy where health professionals or workers directly observe a TB patient's oral intake of prescribed drugs. If the drug treatment regimen is properly designed by the physician and adhered to by the patient, it is almost always successful in bringing about a cure. DOTS programme appears to have been successful in cities/countries as different as Madras, Hong Kong, New York and other parts of the US,

---

<sup>13</sup>Wilson, 1990.

<sup>14</sup>Fairchild and Oppenheimer, 1998.

<sup>15</sup>It is interesting to know that when discussed in isolation, DOTS was initially opposed as too costly and labour-intensive. Annas, 1993; Bayer and Dupuis, 1995.



Tanzania, Peru and China (achieving over an 85 per cent cure rate) where persistently high cure rates over several years have been recorded.<sup>16</sup> However, the implementation of DOTS has encountered some problems. First, estimates reveal that fewer than half of the patients with TB in developing countries have been in contact with treatment services. Only 10 per cent of the world's TB patients have been estimated<sup>17</sup> to have access to DOTS. Furthermore, only 26 of 96 DOTS countries had case detection and cure rates approaching the WHO targets.<sup>18</sup> India, Indonesia, Nigeria and Pakistan, which together account for more than a third of all recorded cases, are not among the 26. Furthermore, the proportion of patients who complete therapy is also a critical indicator of TB program effectiveness.<sup>19</sup> Compliance is an important part of TB control and can be defined as the extent to which a person's health-related behaviour coincides with medical advice.<sup>20</sup> Although the DOTS strategy has been designed to enhance patient compliance, non-compliance is cited as the major barrier to the control and elimination of TB at the level of public health<sup>21</sup> as untreated or partially treated patients develop MDR strains of TB.<sup>22</sup> Approximately one fourth of patients with active TB fail to complete the usual six-months course of treatment within 12 months, and approximately one-third fails to complete preventive therapy. Empirical observations<sup>23</sup> of TB patients suggest that non-compliance is largely due to homelessness,<sup>24</sup> lack of transport, non-availability of drugs

---

<sup>16</sup>Chaulk et al., 1995; Feng-Zeng et al., 1996; Frieden et al., 1995; McKenna et al., 1998; Morse, 1996.

<sup>17</sup>Bayer and Dupuis, 1995; Gangadharam, 1994; Juvekar et al., 1995; Porter and Ogden, 1998; Ravaglione et al., 1997.

<sup>18</sup>The cure rate range between 35 per cent and 95 per cent. Netto et al., 1999.

<sup>19</sup>Centers for Disease Control, 1992.

<sup>20</sup>Snider, 1990.

<sup>21</sup>Addington, 1979; Fox, 1962; Sumartojo, 1993.

<sup>22</sup>Centers for Disease Control, 1989, 1991.

<sup>23</sup>Burkhardt and Nel, 1980; Chaulet, 1990; Farmer et al., 1991; Nuyangulu et al., 1990.

<sup>24</sup>Non compliance approaches 90 per cent among active patients who are also homeless and alcoholic. Brudney and Dobkin, 1991; Werhane et al., 1989.

and lack of infrastructure especially in the rural areas.<sup>25</sup> In the Shimshal Valley, a remote village in Northern Pakistan where 75 per cent of the population lived in overcrowded conditions (more than three person per room), the number of smear positive TB individuals is higher than in other developing countries. Furthermore, only 38 per cent of the patients completed a full course of anti-TB treatment mainly because of unavailability of anti-TB medications, lack of a surveillance program for TB control and poor socio-economic conditions.<sup>26</sup> Since the early 1980s the increase in TB and in MDR-TB have been reported to be part of a larger picture of poverty, homelessness, fragmentation in the public health infrastructure due to insufficient resources for public health TB control activities, deteriorating inner cities, emergence of HIV/AIDS, large numbers of immigrants from countries where TB prevalence is high, poor adherence to treatment and substance abuse.<sup>27</sup>

The resurgence of TB epidemics and the insurgence of a new epidemic of MDR-TB initiated a controversy regarding the relative value of targeted general medical interventions (such as DOTS) versus general economic prosperity reforms or public health infrastructure policies involving investment in housing and infrastructures.<sup>28</sup> Some studies<sup>29</sup> charged that current TB control measures had failed because they failed to address the underlying social conditions of poverty that predispose individuals to TB. Consequently, such limited interventions could by themselves achieve only a partial and temporary success. Other studies,<sup>30</sup> in contrast, interpreted the deterioration of the public health infrastructure since the 1960s - the loss of financing for TB screening, follow-up and treatment, housing and health care services both in urban and rural areas - as the predisposing cause of the re-emergence of TB

---

<sup>25</sup>Hopewell et al., 1988; Twumasi, 1996.

<sup>26</sup>Alvi et al., 1998.

<sup>27</sup>Brudney and Dobkin, 1991; Gittler, 1994; Institute of Medicine, 1992; Reichman, 1991; Sumartojo, 1993.

<sup>28</sup>Bayer and Dupuis, 1995; Brudney and Dobkin, 1991; Lederberg et al., 1992; Wallace, 1990.

<sup>29</sup>Barron, 1993; Bayer, 1996.

<sup>30</sup>Brudney and Dobkin, 1991; Landesman, 1992.



in the 1980s. The epidemic was subsequently the result of HIV disease and insufficient public health planning and investment.<sup>31</sup> Supporters of this view argued that control of TB epidemics requires a structured commitment to find an adequate public health infrastructure and urban planning policies<sup>32</sup> independent of the need for general prosperity changes.<sup>33</sup>

In this work we argue that relying exclusively on the current targeted bio-medical strategy is an inadequate approach to the lasting control of TB.

In the population and epidemiological literature there are various frameworks for analysing the dynamics of infectious diseases and their effects on the population structure. One of the most widely researched is the Lotka-Volterra type model which explores the dynamic interaction between healthy and infected individuals. In this setting, infectious disease spreads by random encounters between the infected individuals and susceptible people where infected individuals are seen as predators of susceptible preys.

In the economic literature some models focus on the effects of economic variables on population growth and quality. As an example, the single sector growth model can accommodate endogenous growth of labour in efficiency units either through human capital effects or through effects on the birth and death rates of the population.

No study has attempted so far to model the interaction between demographic-epidemiological and economic factors in a TB dynamic transmission setting. Modelling efforts focus almost exclusively on the natural history of the infectious disease. TB pathology has been represented by increasingly complex mathematical models that include a variety of features such as: the birth and mortality rates, the disease transmission mechanism, the duration of different types of latency, the period of infectiousness, the recovery rate, the existence of natural or exposure-related immunity or the reinfection rate (both endogenous and exogenous).

In particular, our outstanding issues are:

---

<sup>31</sup>Feldberg, 1995; Landesman, 1992.

<sup>32</sup>Rodrigues and Smith, 1990.

<sup>33</sup>Landesman, 1992.

\*) What are the dynamic properties of a system in which only demographic and epidemiological factors are considered?

\*) Is the possibility of receiving effective TB treatment going to influence the dynamics of the demographic-epidemiological system?

\*) What are the effects of modelling the interdependence of the demographic-epidemiological system with the economy?

\*) Are the overall dynamics of the economic-epidemiological system affected whether demographic-epidemiological factors are functions of general level prosperity or specific public health infrastructure investments?

\*) What is the role played by recovery and by density dependence effects in the context both of the demographic-epidemiological system and of an economic-epidemiological model?

\*) Can a conscious centrally planned policy, either via the increase of the general economic prosperity levels or via investment in public health services, be effective in controlling/eradicating the disease?

The first purpose of the present work is to sharpen the understanding of the dynamics of the two way interaction between the economy and TB. This, in turn, allows us to analyse the interplay between the determinants of the TB epidemiological dynamics and the variables which drive the economic process. Specifically, we model this two-way interaction between the economy and the infection process by integrating a predator-prey Lotka-Volterra type model with the one-sector Solow-Swan (1956) economic growth model. The new system is defined as the *economic-epidemiological growth system*. Furthermore, we divide the population into susceptible and TB infected/infectious individuals and analyse their dynamic interactions where infected people behave as a predators of susceptible preys. Generally, from the perspective of population transmission dynamics we consider latent individuals as part of the pool of susceptible population. This assumption is justified by the short time lag of the incubation period and by the fact that 90 per cent of the infected individuals who do not develop the active disease are part of the productive economy, can become re-infected via air with TB, if exposed



again to the pathogen, and can develop active disease. Also the recovered class is initially assumed to be negligible. However, in different parts of the work we allow for TB infected individuals to receive effective treatment and to be cured as in Chapter 5, Sections 5.1, 5.2 and 5.4. Furthermore, as the probability of TB transmission is critically determined by the frequency and duration of an individual's contact with an infected/infectious person, we believe that the density dependent effect is particularly important in the dynamic analysis of the spread of TB. In more densely populated areas the number of meetings between people is higher than in lower density areas. The model presented in Chapter 3 is structured so that the density dependent effect enters through the interpersonal contact rate. However, in Chapter 4 and Chapter 5 we abstain from considering the density dependent effect and, represent situations where only the structure of the population changes with time. In contrast with the framework developed in Chapter 3, in Chapters 4 and 5, as the interpersonal contact rate is taken as not to include a density dependent effect, we work with a homogenous system. This has the benefit of reducing the dimensionality of the system. At first, as it is our intention to gain important insights about the TB transmission dynamics, our attention is focused on different scenarios where only demographic and epidemiological factors are considered as in Sections 3.1, 4.1 and 5.1. Specifically, Section 3.1 contains a demographic-epidemiological model which captures the density dependent effect while in Sections 4.1 and 5.1 the density dependence is ignored. However, in Section 5.1 the effects on the TB dynamics of the possibility of receiving TB treatment are considered. To analyse the economic-epidemiological interaction between the economic system and the disease we consider the demographic-epidemiological factors to be functions of economic variables. Furthermore, under the assumption that only susceptible individuals are productive, variations in labour force participation are assumed to be a function of TB prevalence. The savings rate is considered exogenously determined<sup>34</sup> and technological progress is as-

---

<sup>34</sup>We relax this assumption in the optimal control setting in Chapter 4 and Chapter 5.

sumed to be zero. Given this approach, we have organised our analysis by laying out two main scenarios of the two way interaction between the TB infectious disease and the economic system.

In Sections 3.2 and 4.2 we have an economic-epidemiological growth model with productive capacity function of human inputs and capital per healthy worker where TB epidemic affects the quality of the population and hence the productivity of the economic system. A large part of the literature suggests that as people become healthier, they contribute more to economic growth because people's ability and productivity are enhanced. The import of smallpox to Mid-America in the 16th century amongst the local population, who had no immune resistance to the disease, led to their decimation, which in turn eliminated the local labour force for working the silver mines. The plague in the Middle East had the effects of reducing the productive work force so heavily that localised famines emerged.<sup>35</sup> Studies in both Ghana and Côte d'Ivoire reveal a negative impact of morbidity in men who reported that their activity had been limited by illness having lower hourly wage rates, reduced hours of work and smaller probability of being in the labour force.<sup>36</sup> Behrmann and Deolalikar (1987) and Behrmann (1993, 1996) have shown that health and nutrition have direct effects on labour productivity among poor individuals. Audiber and Etard (1988)'s results on the impact of schistosomiasis in rice-grower households reveal that changes in health affect the household's use of its labour resources and its ability to utilise other resources. In this work TB is partly controlled by the general level of economic prosperity measured by the capital per healthy labour worker. In this scenario a rising economic prosperity has positive effects both on individuals and on the general infrastructure of the economy. Improvements in housing, diet, working conditions, transport and health infrastructures strengthen the individuals TB resistance, limit involuntary interpersonal contact arising from congestion and offer a better access to health care and services in urban as

---

<sup>35</sup>Watts, 1997.

<sup>36</sup>Schultz and Tausel, 1993.



well as in rural areas. Empirical evidence suggests the existence of a strong connection between economic growth and changes in the spread of infectious diseases (specifically TB).<sup>37</sup> The effects of increasing the general level of prosperity to control infectious diseases transmission are observable from the late 18th century to the early 20th century in the TB epidemics in Europe and America. Although in the long term industrialization brought rising prosperity and decrease of diseases, in the short term, both in Europe, America and part of Africa, it provided the ideal conditions for the establishment of TB that rapidly became the primary cause of death. The emergence of industrial and urban centres, long working hours and poor working conditions, low wages, overcrowded living quarters, poor hygiene and nutrition standards caused a marked increase in TB mortality.<sup>38</sup> The rise of TB in Europe and America was followed by a long period of decline in the prevalence of the disease that was mostly independent of medical intervention (which was almost null through most of the century) and more related to improvements in housing, working conditions and nutrition.<sup>39</sup>

The second scenario is illustrated in Sections 5.2 and 5.3 where we look at the role of public health investment in the TB dynamic transmission. Given that the shortcomings of the present TB control strategies (i.e. DOTS) are due to lack of operation and infrastructure of public health services, here improvements in the basic health infrastructure (e.g. hospitals, medical equipment, transport and supplies) are believed to favour the decline of TB morbidity/mortality rates and hence reduce the source of new TB infections.

As such, even without any conscious policy initiative, there are economic effects to control the spread of TB infectious disease either via productive capital or via public health investment. Nevertheless, economic policy can also be used in a more direct way to control the disease. Priorities in the phasing of policy to reduce the spread of TB infectious disease are here examined by carrying out an optimal control analysis of the current TB and

---

<sup>37</sup>Lee and Paxman, 1997; Porter and Ogden, 1988.

<sup>38</sup>Stephens, 1995.

<sup>39</sup>Packard, 1989.

MDR-TB epidemics based on the integrated economic-epidemiological view of causality in TB. Specifically, in Section 4.3, ignoring density dependence effects and the possibility of recovery, we consider the case of a central planner who determines savings so that social welfare, function of the accumulation of productive capital and of the level of TB prevalence, is maximised. In Section 5.4, although density dependence effects are ignored, we allow individuals to receive treatment and to be cured. In this setting, we consider a central planner facing a TB epidemic and who chooses his actions so that the division of output between consumption and public health investment is set to maximise social welfare.

The overall structure of this study is as follows.

**Chapter 2** contains a critical survey of the literature this work refers to. A brief review of the mathematical concepts adopted is provided in Section 2.1. In Section 2.2 attention is devoted to contributions in epidemiological literature which consider the dynamic transmission of infectious disease in human population as a function of exogenously determined demographic and/or epidemiological factors (i.e. the net population growth rate or the disease transmission coefficient). A summary of the current understanding of the clinical/pathological course of TB infection, definition and basic concepts in epidemiology are initially provided in Section 2.2.1 and 2.2.2, respectively. The predator-prey Lotka-Volterra model is briefly recalled in Section 2.2.3. The existing epidemiological literature is reviewed in the light of three different factors: the contact rate, the incubation period (latent status) and the role of the recovered class in Sections 2.2.4, 2.2.5 and 2.2.6, respectively. Section 2.3 considers studies from the economic growth literature that focus on the effects of population dynamics, mediated by the production factors on the economic growth. We use three central issues of growth economics to organize this work: the savings rate, technological progress and the endogenous growth rate of population.

Despite the existence of a copious epidemiological and economic growth literature, no study has attempted so far to model the interaction between



demographic-epidemiological and economic factors in a TB dynamic transmission setting. **Chapter 3** provides a unified approach capable of explaining all the relevant interactions between the spread of infectious disease and the economic system. In the first section (Section 3.1), referring to the predator-prey Lotka-Volterra type model in Blower et al. (1995) and Anderson and May (1991), we analyse the transmission of infectious disease by considering only demographic and epidemiological parameters. The model developed in the second section (Section 3.2) provides a general analytic framework where economic variables with demographic-epidemiological effects are included to bridge the infectious disease dynamics and the economic process. Specifically, we integrate the predator-prey Lotka-Volterra type stylized model used by Blower et al. (1995) to describe the dynamics of the TB infection process with the one-sector Solow-Swan economic growth model with endogenous population growth. The net growth rate of the susceptible people, the infection rate and the mortality rate are initially dependent on economic prosperity measured by capital per healthy worker ratio. We assume, as the empirical evidence suggests that the infection rate and the mortality rate of the infected individuals both fall with increasing prosperity. Although there is a contradictory evidence about how the net birth rate of susceptible people changes with respect to variations in economic prosperity here we assumed that the net birth rate increases for increasing prosperity. We also provide a calibrated example in which the net birth rate of the healthy people decreases with economic prosperity.

Optimal control policies to contain TB infectious disease are discussed in **Chapter 4** and **Chapter 5**. In considering TB infectious disease, intervention is possible at all points in the disease process. High risk groups for TB can be identified and targeted for preventive treatment therapy; this includes the use of screening for infection and then the provision of chemoprophylaxis, which as well as treating the individual prevents further spread of the disease.<sup>40</sup> A new public housing policy can reduce the degree of physical contact

---

<sup>40</sup>Ginsberg, 1998; Hurtig et al., 1999; Netto et al., 1999; WHO, 2000a, b.

between infected and non-infected individuals and consequently the extent of overcrowding and lack of ventilation at home/workplaces which inhibits the spread of TB. A new public health infrastructure, including transport facilities, can improve access to health care both in rural and urban areas.<sup>41</sup> A broader social policy to increase economic prosperity may be directed towards the maintenance of higher standards of living (i.e. drainage, food and water purity).<sup>42</sup> In this work it is argued that the current targeted bio-medical interventions are an inadequate approach to the lasting control of TB as they fail to consider the social and economic dimensions of TB.<sup>43</sup> This argument is developed in Chapter 4 where we argue that a more comprehensive strategy which stresses the role that socio-economic factors play in controlling TB is required as it addresses the fundamental causes of the disease: poverty, malnourishment, overcrowded and insanitary living and working conditions. Specifically, Section 4.1 introduces the demographic-epidemiological model used and explores their equilibrium points and dynamics. Section 4.2 contains a dynamic analysis of the general economic prosperity model where economic prosperity is measured by the ratio of productive capital to the number of healthy workers. Section 4.3 illustrates the case of a centrally planned economy in which savings are chosen to balance the welfare effects of current and future consumption and the effects of capital accumulation on controlling TB. In Chapter 5 it is argued that the fundamental problems of the current TB control programs, poor compliance and limited access to TB treatment, can be addressed by improvements in the basic health infrastructure (e.g. hospitals, medical equipment, transport and supplies). Public health interventions are believed to favour the access to TB treatment and to enhance the compliance rate and, consequently, the probability for an individual to complete the TB treatment and to be eventually cured.<sup>44</sup> Here TB

---

<sup>41</sup>Fairchild and Oppenheimer, 1998; Gittler, 1994; Hurtig et al., 1999.

<sup>42</sup>Farmer, 1996; Fineberd and Wilson, 1996; Freudenberg, 1995; Frieden, 1994; Hurtig et al., 1999; Jaramillo, 1999; Lerner, 1993; Rodrigues and Smith, 1990; Sommer, 1995.

<sup>43</sup>Cantwell et al., 1994; Dubos and Dubos, 1987; Lerner, 1993; McKeown, 1976; Spence et al., 1993.

<sup>44</sup>Addington, 1979; Alvi et al., 1998; Brudney and Dobkin, 1991; Centers for Disease



preventive care is also considered. Public health investment as improvements of screening in high risk areas/institutions or drug therapy<sup>45</sup> for latent TB infected individuals, enhance the probability of rendering the patient non-infectious, thereby protecting others from becoming infected due to contact with the patient. Specifically, this chapter develops a model for the dynamic analysis of the spread of TB where the possibility for TB infected individuals to receive treatment and to be cured is explored. Section 5.1 sets out an epidemiological model of population dynamics in the presence of TB infectious disease with the possibility of recovering from the TB infection. Section 5.2 develops an economic-epidemiological dynamic model where demographic and epidemiological parameters (the net population growth rate of the susceptible individuals, the TB transmission rate, the total death rate of the infected people and the recovery rate) are functions of specific public health infrastructure investment. A descriptive analysis of TB dynamic without recovery is considered in Section 5.3. Section 5.4 discusses the implications of our analysis for public health infrastructure investment to limit the spread of TB infectious disease.

In Chapters 3, 4 and 5, for each Section we present analytic results followed by results from a calibrated version of the model using realistic estimates of the demographic, epidemiological and economic parameters. We use a variety of data sets from the World Bank (WB) and World Health Organization (WHO) sources.<sup>46</sup>

Conclusions and open research areas are provided in **Chapter 6**. Finally, the **Appendix** reviews some of the mathematical calculations.

---

Control, 1989, 1991; Fox, 1962; Gittler, 1994; Hopewell et al., 1988; Institute of Medicine, 1992; Reichman, 1991; Sumartojo, 1993; Twumasi, 1996;.

<sup>45</sup>Drug therapy, based on isoniazid prescription for 12 months, has been proved to be effective in treatment of individuals with latent TB infection to prevent their development of clinically active TB. Center for Disease Control, 1990, 1991, 1992, 1993; Gittler, 1994; Sumartojo, 1993; Tulsy et al., 1998.

<sup>46</sup>World Bank, 2000; World Health Organization, 2000b, d.

## 2 Critical Literature Review

This chapter contains a critical survey of the literature relevant to this work. A brief review of the mathematical concepts adopted is provided in Section 2.1. Attention is then devoted (Section 2.2) to contributions in the epidemiological literature which consider the dynamic transmission of infectious disease in human population as a function of exogenously determined demographic and/or epidemiological factors (i.e. the net population growth rate or the disease transmission coefficient). Subsequently, in Section 2.3, we consider studies from the economic growth literature<sup>47</sup> which focus on the effects of population dynamics, mediated by the production factors on the economic growth. This section also includes a review of population growth models which, considering population growth as endogenous, examine the prevailing economic conditions and their consequences on demographic fluctuation.

### 2.1 The Theory of Nonlinear Dynamical Systems: Stability Analysis

To investigate the general dynamical features of economic models for interacting population, the theory of nonlinear dynamical systems, that is based on the qualitative (geometric) theory of differential (and difference) equations, is applied.<sup>48</sup>

In general matrix form, an analytical model that describes the dynamic of  $n$  classes in a population can be represented as an autonomous<sup>49</sup> system<sup>50</sup> in  $\mathbb{R}^n$  of  $n$  non-linear ordinary differential equations where  $Z = Z_1 \dots Z_n$

---

<sup>47</sup>Contributions to economic theory of infectious diseases which are mainly concerned with differential disease prevalence across population groups, as determined by the difference in protection costs relative to infection cost, are not included in this study.

<sup>48</sup>Dankowicz, 1997; Grimshaw, 1990; Medio and Gallo, 1992; Verhulst, 1996.

<sup>49</sup>In an autonomous system, the functions do not depend on time,  $t$ , and its flows are determined by the equilibrium points.

<sup>50</sup>The assumption of an autonomous system in the field of optimal control theory allows to apply the steady state analysis avoiding the use of transversality condition not



$$\dot{\mathbf{Z}}_i = \phi(\mathbf{Z}) = \phi_i(\mathbf{Z}) \quad (1)$$

Given certain initial conditions  $Z(0)$ , as time  $t$  varies,  $\mathbf{Z}$  traces a curve in the  $\mathbf{Z}$  space. This curve is known as a *trajectory* and the  $\mathbf{Z}$  space is called *phase space* (or *phase plane* if  $n = 2$ ).

If there is a  $\mathbf{Z}^*$  such that  $\phi(\mathbf{Z}^*) = 0$ , then  $\mathbf{Z}^*$  is a stationary state. A *steady-state* represents a situation in which the relevant variables all grow at an identical rate. A situation in which the growth rate is zero and, therefore, the relevant variables all remain constant, is called a *stationary-state*. In the present application, where  $\mathbf{Z}$  refers to population groups it makes sense to restrict attention to  $\mathbf{Z}^* \geq 0$ .

*Stability analysis* examines whether solutions remain or become close to  $\phi(\mathbf{Z}^*)$  for all times.<sup>51</sup> La Salle and Lefschetz (1961) define an equilibrium point to be stable whenever a solution path from an arbitrary initial condition remains bounded in the interior of the overall space for all times. For example a centre is stable. They define asymptotic (global) stability to be the case in which any trajectory starting from an arbitrary initial condition actually converges to the equilibrium point as  $t \rightarrow \infty$ . The equilibrium point is said to be locally stable if any trajectory with an initial condition in a neighbourhood of the equilibrium point converges to the equilibrium point as  $t \rightarrow \infty$ . The behaviour of such a system in the phase space can be examined by analysing the stability properties of the steady or stationary state solutions. With a linear system both its global and local stability properties are determined by its eigenvalues (direction of movements). For a non-linear system the local stability properties can be investigated by approximating it with a linear

---

necessarily applicable in an infinite horizon setting. Chiang, 1992.

<sup>51</sup>*Structural stability* refers to the qualitative effects upon solutions of the model equations produced by gradual variation in the model parameters themselves, that is by modifications in the structure of the basic equations. If the solutions change in a continuous manner (if the perturbed system is topologically isomorphic to the perturbed one) the system is said to be structurally stable. Grimshaw, 1990.

system in the neighbourhood of a stationary point. Usually relying on the fact that around the equilibrium points the local behaviour of a nonlinear system is qualitatively similar to that of the linearized one.<sup>52</sup>

To study the local dynamic of the system it is necessary to perform an expansion in a Taylor series in the neighbourhood of each of its equilibrium points neglecting all nonlinear terms.

The Taylor expansion around any equilibrium  $\mathbf{Z}^*$  is given by<sup>53</sup>

$$\phi(\mathbf{Z}^* + \varepsilon) = \phi(\mathbf{Z}^*) + \mathbf{A}\varepsilon + \boldsymbol{\theta}(\varepsilon) \quad (2)$$

where  $\mathbf{A}$  is the Jacobian matrix of (2) evaluated at  $\phi(\mathbf{Z}^*)$

$$\mathbf{A} = \begin{bmatrix} \frac{\partial \phi_1(\mathbf{Z}^*)}{\partial Z_1} & \cdots & \frac{\partial \phi_1(\mathbf{Z}^*)}{\partial Z_n} \\ \vdots & & \vdots \\ \frac{\partial \phi_n(\mathbf{Z}^*)}{\partial Z_1} & \cdots & \frac{\partial \phi_n(\mathbf{Z}^*)}{\partial Z_n} \end{bmatrix} \quad (3)$$

Here  $\frac{\boldsymbol{\theta}(\varepsilon)}{|\varepsilon|}$  is a continuous vector function of  $\varepsilon$  that vanishes as  $\varepsilon \rightarrow 0$ . The approximate linearized system  $\dot{\varepsilon} = \mathbf{A}\varepsilon$  can be used to deduce the local stability properties of the steady state solutions of  $\phi(\mathbf{Z}^*) = \mathbf{A}\varepsilon + \boldsymbol{\theta}(\varepsilon)$ . The Jacobian matrix of the nonlinear system evaluated at the equilibrium points is a distinguishing property of the reduced linearization. The orbit structure of a linearized system depends on the eigenvalues of the Jacobian matrix. The analysis of the eigenvalues and of the eigenvectors expressed in terms of the Jacobian and the trace of the Jacobian is required to understand the dynamics of the linearized system.<sup>54</sup> The general solution is

---

<sup>52</sup>This assumption holds under general conditions (i.e. when the vector function  $\phi(\mathbf{Z})$  is continuously differentiable in a neighbourhood of  $\mathbf{Z} = 0$ ). Verhulst, 1996.

<sup>53</sup>According to the linear theory, a linear approximation to a general function  $\phi(\mathbf{Z})$  can give the exact value of  $\phi(\mathbf{Z}^*)$  at the point of expansion, but will have progressively larger errors of approximation as moving farther away from the point of expansion. Hubbard and West, 1995.

<sup>54</sup>Since the dynamic properties of the equilibrium points are controlled by the sign of the

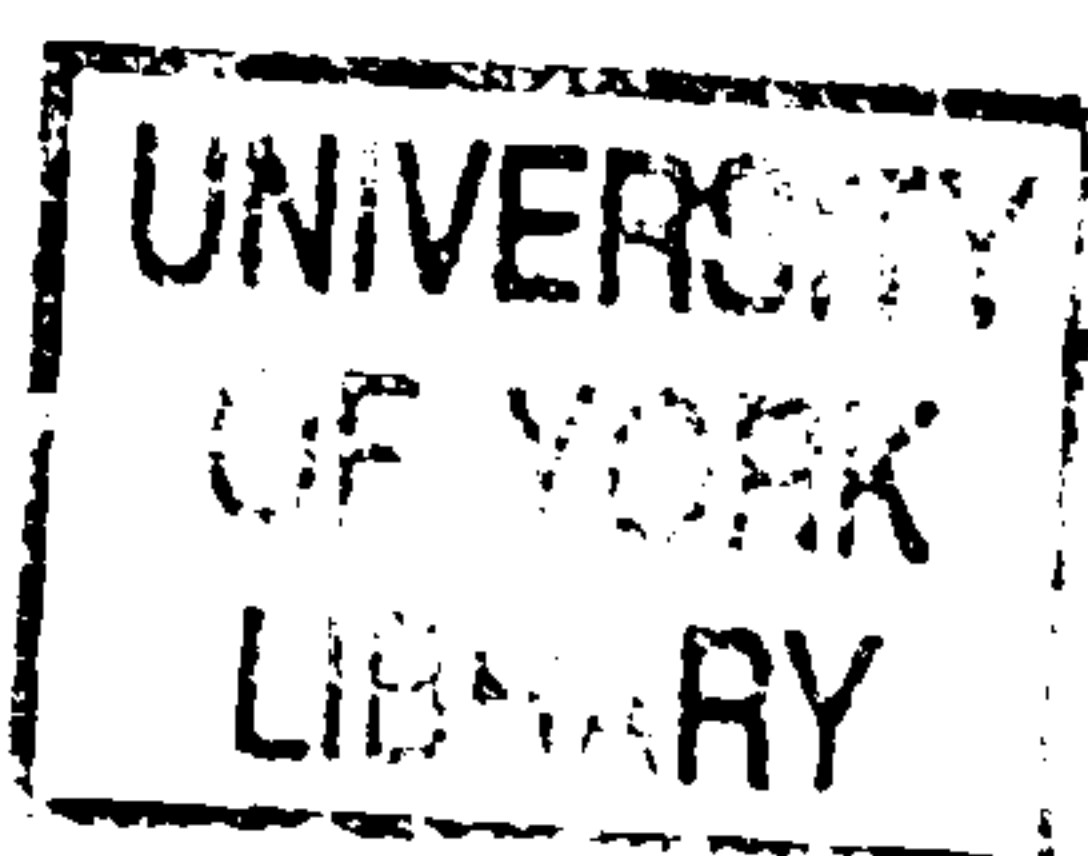



$$\begin{bmatrix} Z_1(t) \\ Z_2(t) \\ \dots \\ Z_n(t) \end{bmatrix} = \begin{bmatrix} B_{11} \\ B_{21} \\ \dots \\ B_{n1} \end{bmatrix} e^{\eta_1 t} + \begin{bmatrix} B_{12} \\ B_{22} \\ \dots \\ B_{n2} \end{bmatrix} e^{\eta_2 t} + \dots + \begin{bmatrix} B_{1n} \\ B_{2n} \\ \dots \\ B_{nn} \end{bmatrix} e^{\eta_n t} \quad (4)$$

where  $\mathbf{B}$  is an arbitrary constant column vector and the eigenvalues  $\eta_{1,2,\dots,n}$  are given by the roots of the characteristic polynomial of the matrix  $\mathbf{A}$  and thus are solutions of

$$\det \begin{bmatrix} a_{11} - \eta & a_{12} & \dots & a_{1n} \\ a_{21} & a_{22} - \eta & \dots & a_{2n} \\ \dots & \dots & \dots - \eta & \dots \\ a_{n1} & a_{n2} & \dots & a_{nn} - \eta \end{bmatrix} = 0 \quad (5)$$

As local analysis focuses on the behaviour of the system in a small neighbourhood of a single point, the generality of nonlinear systems escapes full analytical investigation.<sup>55</sup> That is, structural changes (i.e. changes of the nature of critical points) are not captured by linear approximation method. Moreover, in case of multiple equilibria, local stability analysis cannot be 

---

real part of the eigenvalues (in particular, by the eigenvalues themselves if they are real), the neighbourhood stability analysis can be restricted to obtain qualitative information. Sturm's Method is designed to provide qualitative information by indicating the number of distinct real roots of an equation in a particular interval. The method is also an essential step in quantitative procedures which finds numerical approximations to the roots of the equations.

<sup>55</sup>The method of *Liapunov functions* can occasionally be applied in rigorous analytic proofs of global stability. This approach requires to consider the fully non-linear equation seeking a scalar function of  $\mathbf{Z}$  that can be considered as a measure of the "energy" of the system. Whether this energy decreases or increases at  $t \rightarrow \infty$  indicates stability or instability of the system. However, if there are multiple equilibria, it is difficult to demonstrate global stability using Liapunov functions. More details about the Liapunov function can be found in Grimshaw, 1990; Hubbard and West, 1995; Medio and Gallo, 1992; Nisbet and Gurney; 1982.

used to explore the dynamic movements of the system between the stationary points.

The two dimensional system in  $\mathfrak{R}^2$  is most accessible to analysis. For  $n = 2$ , the Jacobian matrix has two eigenvalues, respectively,  $\eta_1$  and  $\eta_2$ . For each of the following cases, the equilibrium point have different qualitative properties. Specifically, the behaviour of the solutions is controlled by the sign of the real part of the eigenvalues (in particular, by the eigenvalues themselves if they are real). The following cases are identified:

- $\eta_1$  and  $\eta_2$  as real and distinct eigenvalues.<sup>56</sup>
  - $\eta_1$  and  $\eta_2$  have the same sign. The equilibrium point is a *node* (*positive attractor* for  $\eta_1 < \eta_2 < 0$  *negative attractor* for  $\eta_1 > \eta_2 > 0$ ).
  - $\eta_1$  and  $\eta_2$  have different signs. The equilibrium is a *saddle point*.
- $\eta_1$  and  $\eta_2$  are a pair of complex conjugate numbers:  $\eta_1, \eta_2 = \alpha \pm i\beta$ ,  $\beta \neq 0$ . The equilibrium point is approached in an oscillatory manner:
  - for  $\alpha \neq 0$ , the equilibrium is a *focus* (*sink* for  $\alpha < 0$  and *source* for  $\alpha > 0$ ):
  - for  $\alpha = 0$ , the eigenvalues are purely imaginary and the equilibrium is a *centre*.
- $\eta_1$  and  $\eta_2$  as a double eigenvalue:  $\eta_1 = \eta_2 = \lambda$ . The equilibrium point is a *star* (*positive* or *negative attractor* depending on the sign of  $\lambda$ ) according to the solutions of the system.

When higher dimensions are considered more complicated situations

---

<sup>56</sup>A special case is for  $\eta_1$  or  $\eta_2 = 0$  when the system is characterized by a *line of equilibria* (*positive* or *negative attractors* depending on the sign of the non-zero eigenvalue).

arise.<sup>57</sup> For  $n = 3$ , the Jacobian matrix has three distinct eigenvalues, respectively,  $\eta_1, \eta_2$  and  $\eta_3$ .

The linear differential equations with constant coefficients in  $\mathfrak{R}^3$  fall into the following main classes:<sup>58</sup>

- where  $\eta_1, \eta_2$  and  $\eta_3$  are real and distinct eigenvalues, the equilibrium points are *three-dimensional node* (*positive* or *negative attractors* depending on whether  $\eta_1, \eta_2$  or  $\eta_3 < 0$  or  $\eta_1, \eta_2$  and  $\eta_3 > 0$ , respectively);
- where  $\eta_1$  and  $\eta_2$  have a negative real part and  $\eta_3$  has a positive real part, the equilibrium points are *saddles* (stable direction);
- where  $\eta_1$  has a negative real part and  $\eta_2$  and  $\eta_3$  have a positive real part, the equilibrium points are *saddles* (unstable direction);
- where  $\eta_1$  and  $\eta_2$  are purely imaginary number  $\pm i\beta$  and  $\eta_3$  is a real number, the equilibrium points are *centres* with only one direction of attraction (*positive* or *negative attractor* for  $\eta_3 < 0$  or  $\eta_3 > 0$ , respectively).
- where  $\eta_1$  and  $\eta_2$  are complex conjugate numbers  $= \alpha \pm i\beta$  and  $\eta_3$  is a real number. When  $\eta_3 > 0$  the equilibrium points are *focus source* (*positive* or *negative attractor* for  $\alpha < 0$  or  $\alpha > 0$ , respectively). When  $\eta_3 < 0$  the equilibrium points are *focus sink* (*positive* or *negative attractor* for  $\alpha < 0$  or  $\alpha > 0$ , respectively).

The location of the eigenvalues for two and three dimensional systems is provided in Figs. 1a, b, Figs. 2a, b, respectively, where the eigenvalues are represented as dots in complex planes (real axis horizontally and imaginary axis vertically).<sup>59</sup> The phase diagrams are in Figs. 3a, b, c.

---

<sup>57</sup>Except in some special cases, fifth and higher order degree polynomial equations cannot be solved by algebraic methods. Third and fourth degree equations require considerably complex procedure.

<sup>58</sup>The cases non included in this classification are considered degenerate critical points as the equilibrium points has at least one eigenvalues equal to zero.

<sup>59</sup>In drawing these diagrams we took inspiration from Verhulst, 1996.



More generally, since the equations are nonlinear, the dynamic is quite complicated and a neighbourhood stability analysis may give a misleading representation of the full global stability.

## 2.2 Epidemiological Literature View of Infectious Diseases: the Case of Tuberculosis

The first contributions to the theory of epidemics can be traced back to the early part of the 20th century. Hamer's (1906) model constitutes the first attempt to define the spread of an epidemic as depending on the contact rate between susceptible and infectious individuals. This work introduces what has become one of the most relevant concepts in mathematical epidemiology: the *mass action principle*. Following Hamer's discrete time model, Ross (1908, 1911) presents models in continuous time on the spread of malaria in human and mosquito populations in which he states that, for any given set of malaria-related circumstances, a minimum number of mosquitos is needed to keep the transmission going. If the number falls below this level, the disease would progressively decrease to eventually become extinct. If the number is above this level it would maintain itself or grow. Lotka (1925) reviews Ross's work obtaining a model in terms of differentials which leads to a "logistic" type integral equation used to describe population growth. Kermack and McKendrick's (1927) mathematical formulation of an epidemic in a homogeneous population introduces the *threshold theorem* in which it is stated that a threshold density of population, depending upon the infectiousness, recovery and death rates, constitutes the minimum population level for an epidemic to occur.

Reviews of the numerous contributions to the spread and dynamics of epidemics that followed these pioneering works have been provided by Bailey (1975), Anderson and May (1991). In these studies emphasis is given to contributions to the analysis of the recent recurrence of TB epidemic. The dynamics of the disease can be better analysed by looking at the pathological course of TB as a three stage process, where the first stage corresponds to



the acquisition of the initial primary infection by a contact with a previously infected and infectious person (passive TB), the second stage with the development of the disease after having been previously infected (active TB) and the third stage to the cure of the disease after a treatment therapy.<sup>60</sup> Each of these stages has different risk factors: the probability of being infected, the probability that the disease becomes active, the probability of receiving full treatment and being cured and the probability of developing the disease again once cured.

The approach adopted here is to review the existing literature in the light of these different risk factors.

Section 2.2.4 focuses on the interpersonal contact between an individual and a previously infected/infectious person and the factors which influence it. Section 2.2.5 analyses the passage from the latent status to the activation of the disease. Section 2.2.6 examines the role of the recovered class. Before moving on, in Sections 2.2.1, 2.2.2 and 2.2.3, we review some definitions and basic concepts in epidemiology together with some basic epidemiological models existing in the literature (i.e. Lotka-Volterra predator-prey model and prevalence/density models).

### 2.2.1 Clinical and Pathological Course of Tuberculosis

TB is a bacterial chronic disease caused by *Mycobacterium Tuberculosis* (and occasionally by *Mycobacterium Bovis* and *Mycobacterium Africanum*). These organisms are also known as tubercle bacilli (because they cause lesions called tubercles) or as acid-fast bacilli.

---

<sup>60</sup>A person is said to have received full treatment and be cured if he/she has completed the treatment and is smear negative at least one month prior the completion of the treatment. WHO, 1998b.



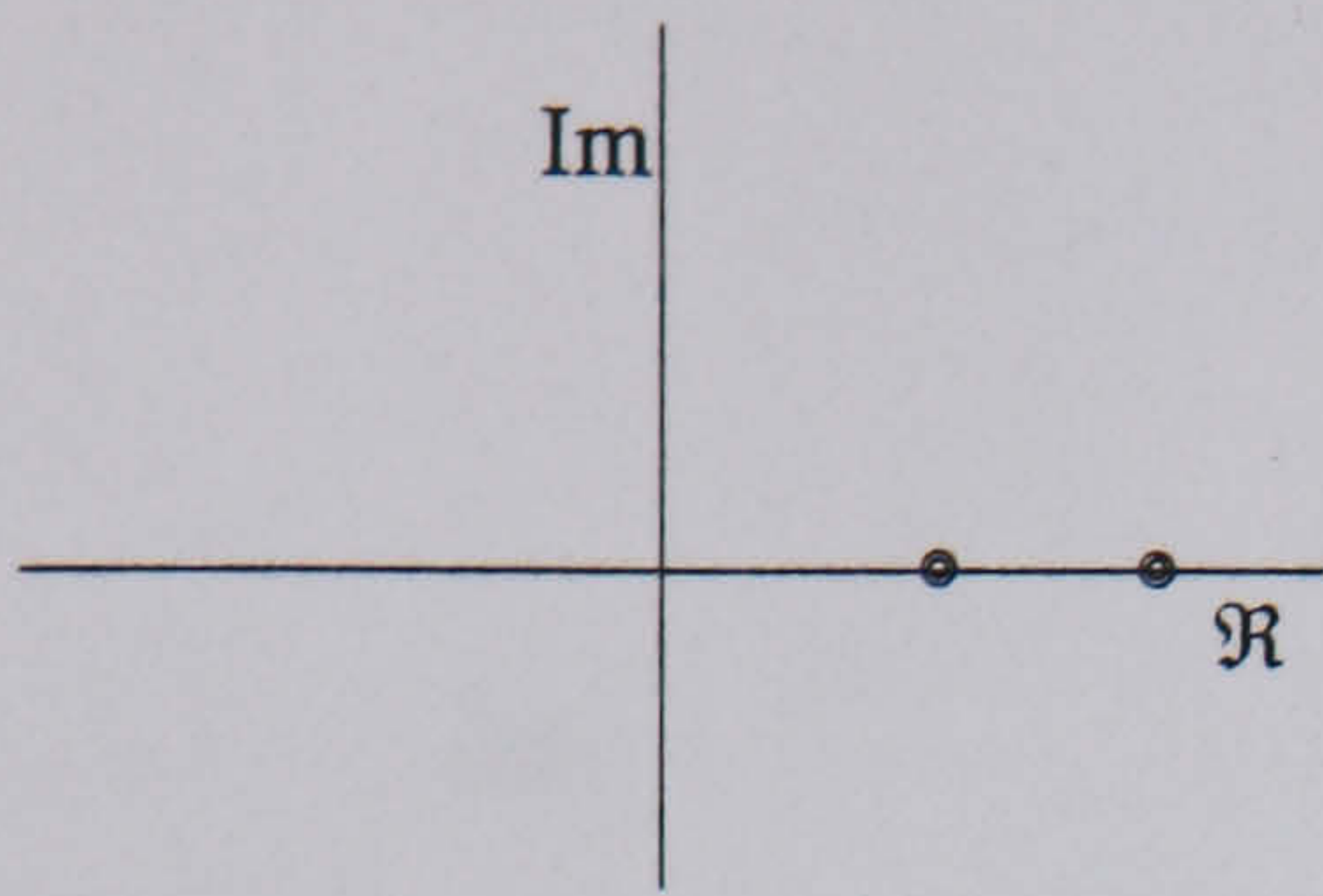

Node (negative attractor)  
 $\eta_1$  and  $\eta_2$  real and distinct eigenvalues  
 $\eta_1 > 0$   $\eta_2 > 0$

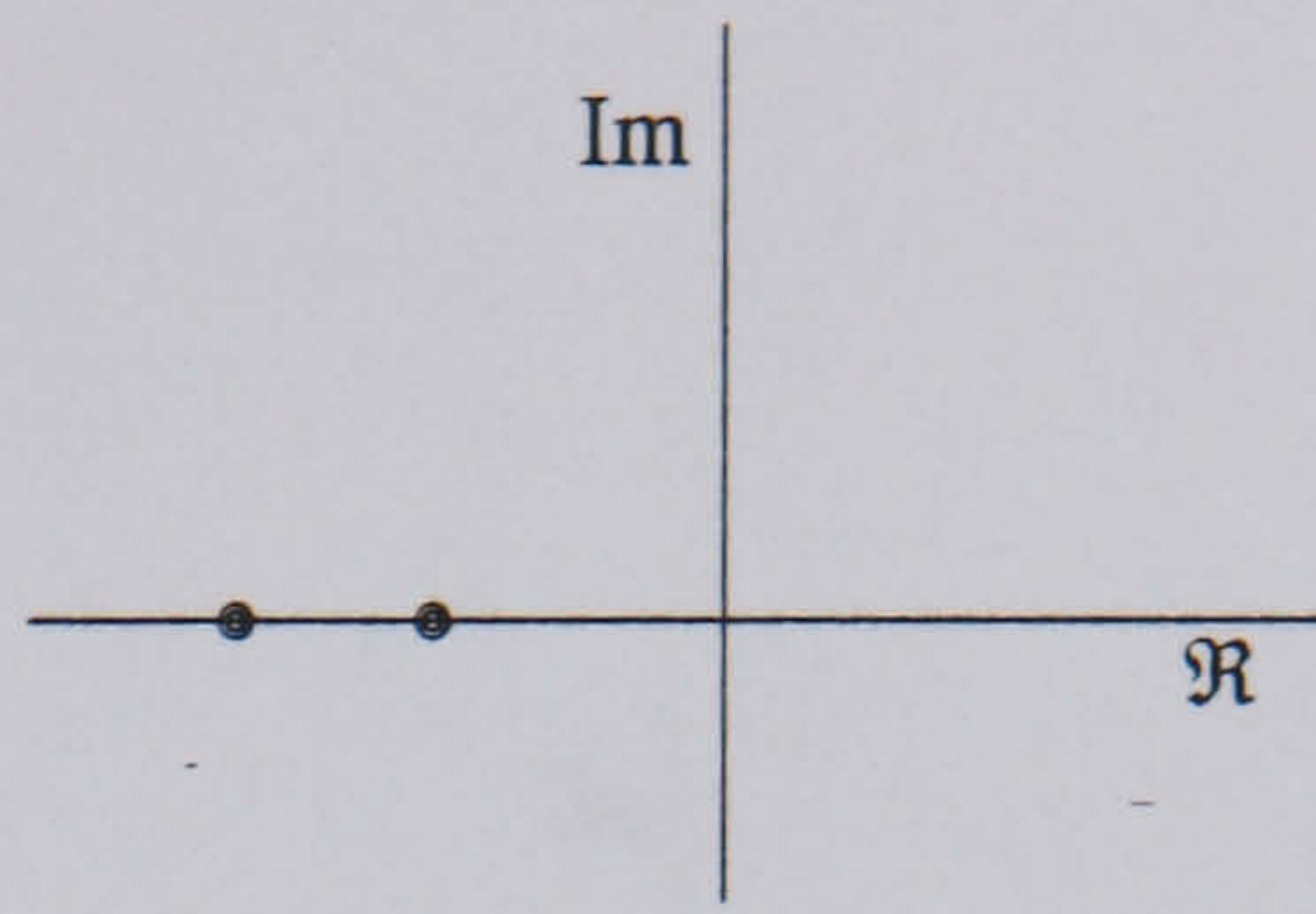

Node (positive attractor)  
 $\eta_1$  and  $\eta_2$  real and distinct eigenvalues  
 $\eta_1 < 0$   $\eta_2 < 0$

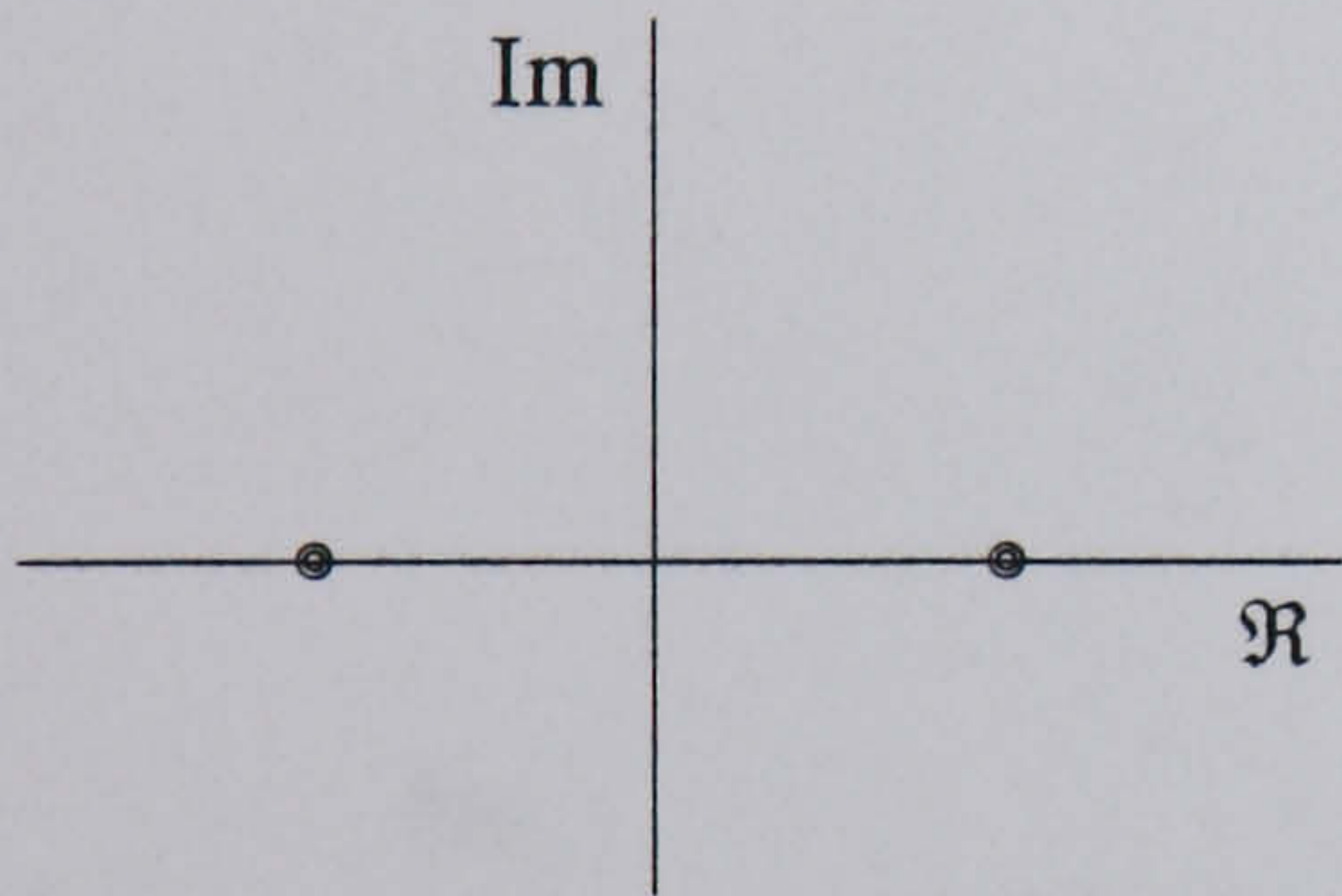

Saddle point  
 $\eta_1$  and  $\eta_2$  real and distinct eigenvalues  
 $\eta_1 > 0$   $\eta_2 < 0$

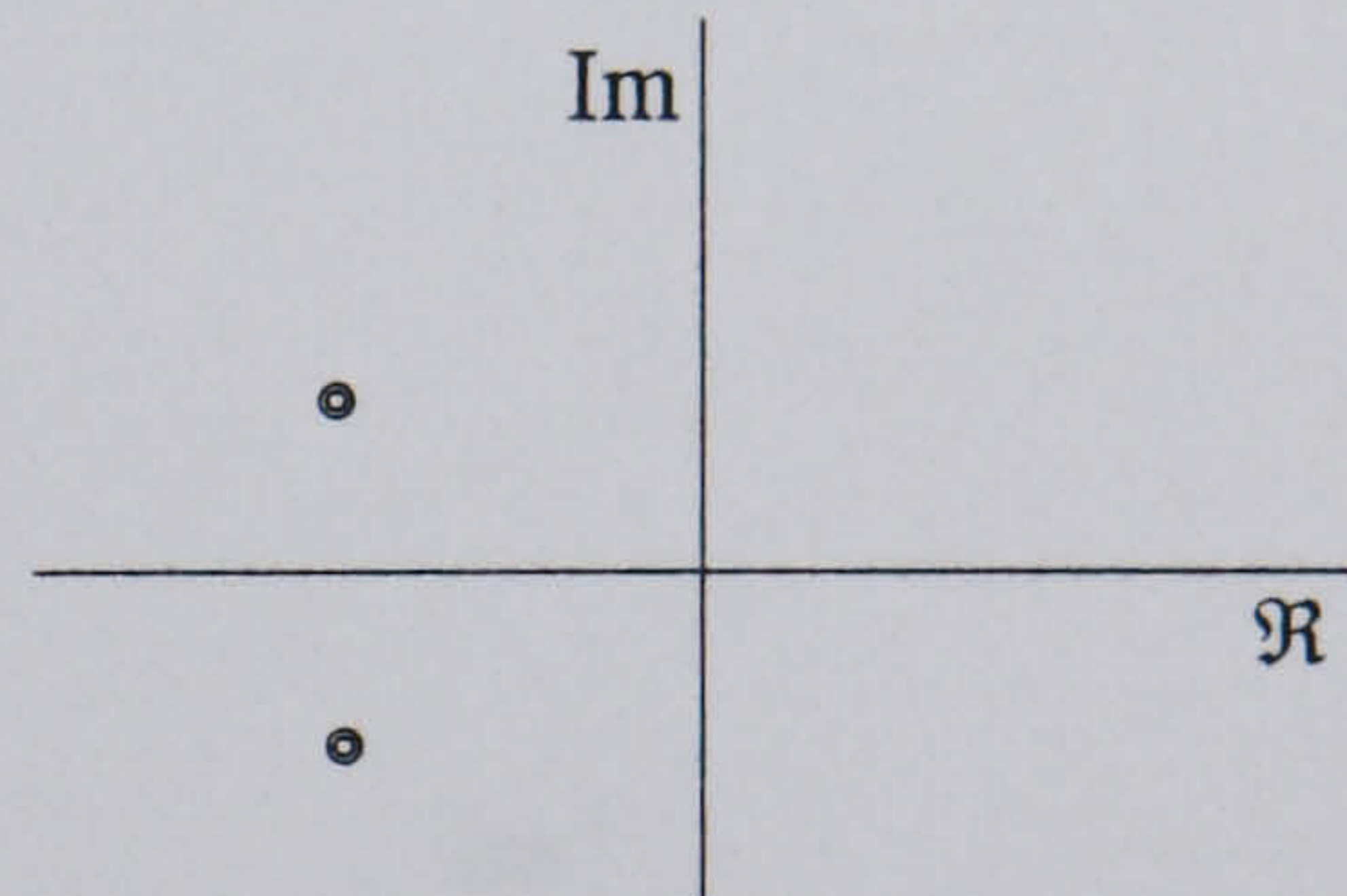

Focus sink  
 $\eta_1$  and  $\eta_2$  complex eigenvalues  
 $\eta_{1,2} = \alpha \pm i\beta$   $\alpha < 0$

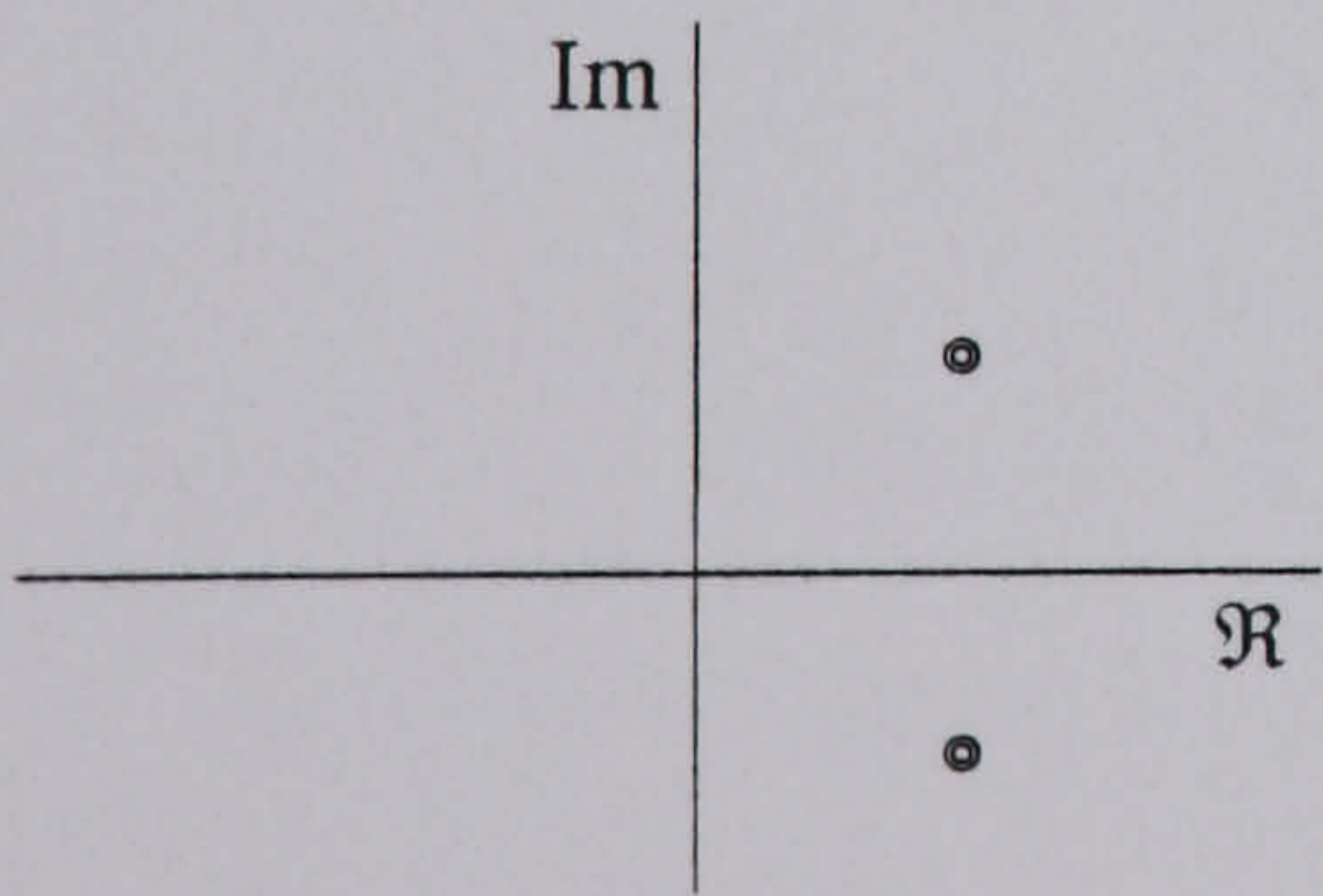

Focus source  
 $\eta_1$  and  $\eta_2$  complex eigenvalues  
 $\eta_{1,2} = \alpha \pm i\beta$   $\alpha > 0$

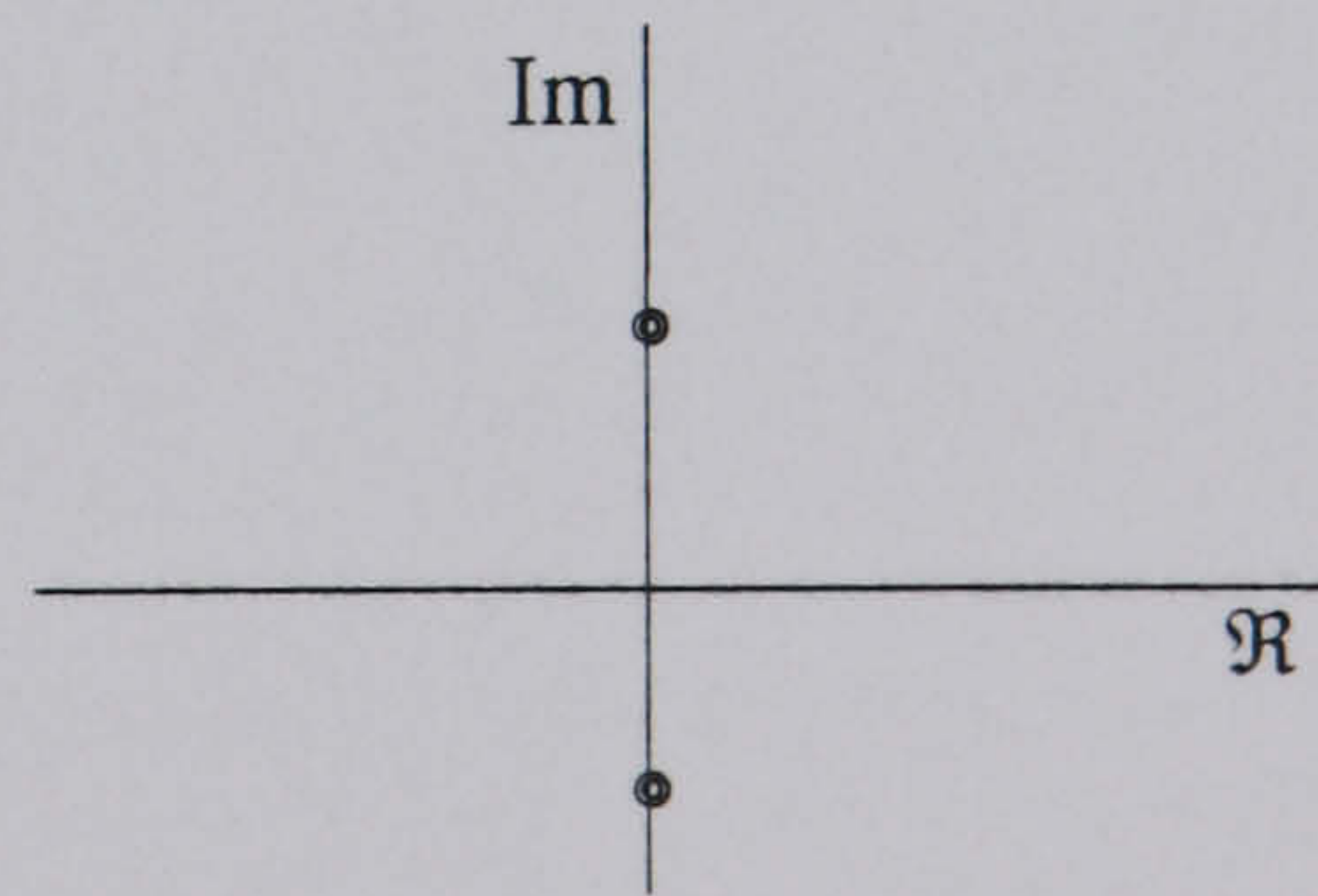

Centre  
 $\eta_1$  and  $\eta_2$  complex eigenvalues  
 $\eta_{1,2} = \alpha \pm i\beta$   $\alpha = 0$

Fig. 1 a) Eigenvalues diagram for two dimensional linear systems



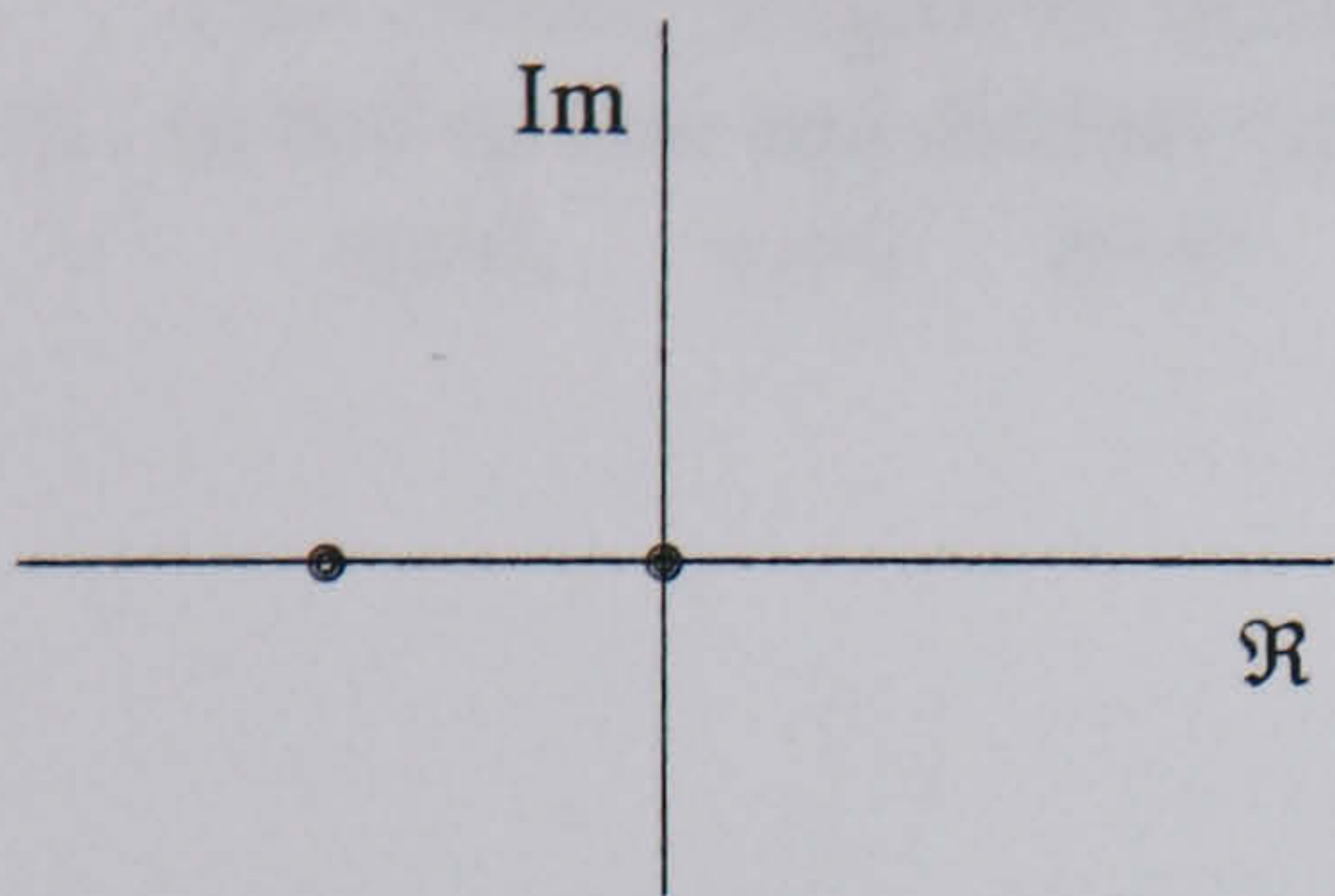

Line of equilibria (positive attractor)  
 $\eta_1$  and  $\eta_2$  real and distinct eigenvalues  
 $\eta_1=0, \eta_2<0$  or  $\eta_1<0, \eta_2=0$

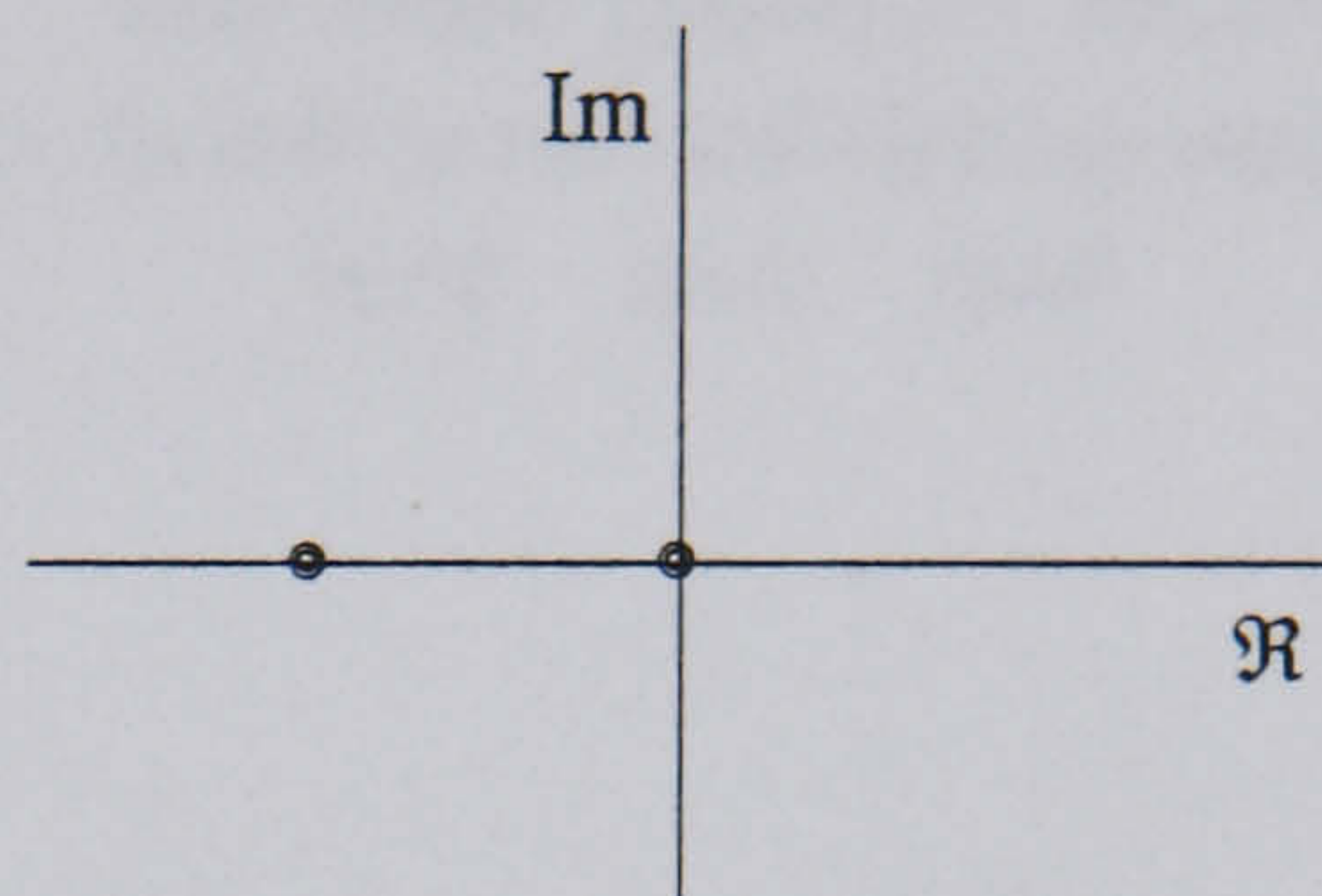

Line of equilibria (negative attractor)  
 $\eta_1$  and  $\eta_2$  real and distinct eigenvalues  
 $\eta_1=0, \eta_2>0$  or  $\eta_1>0, \eta_2=0$

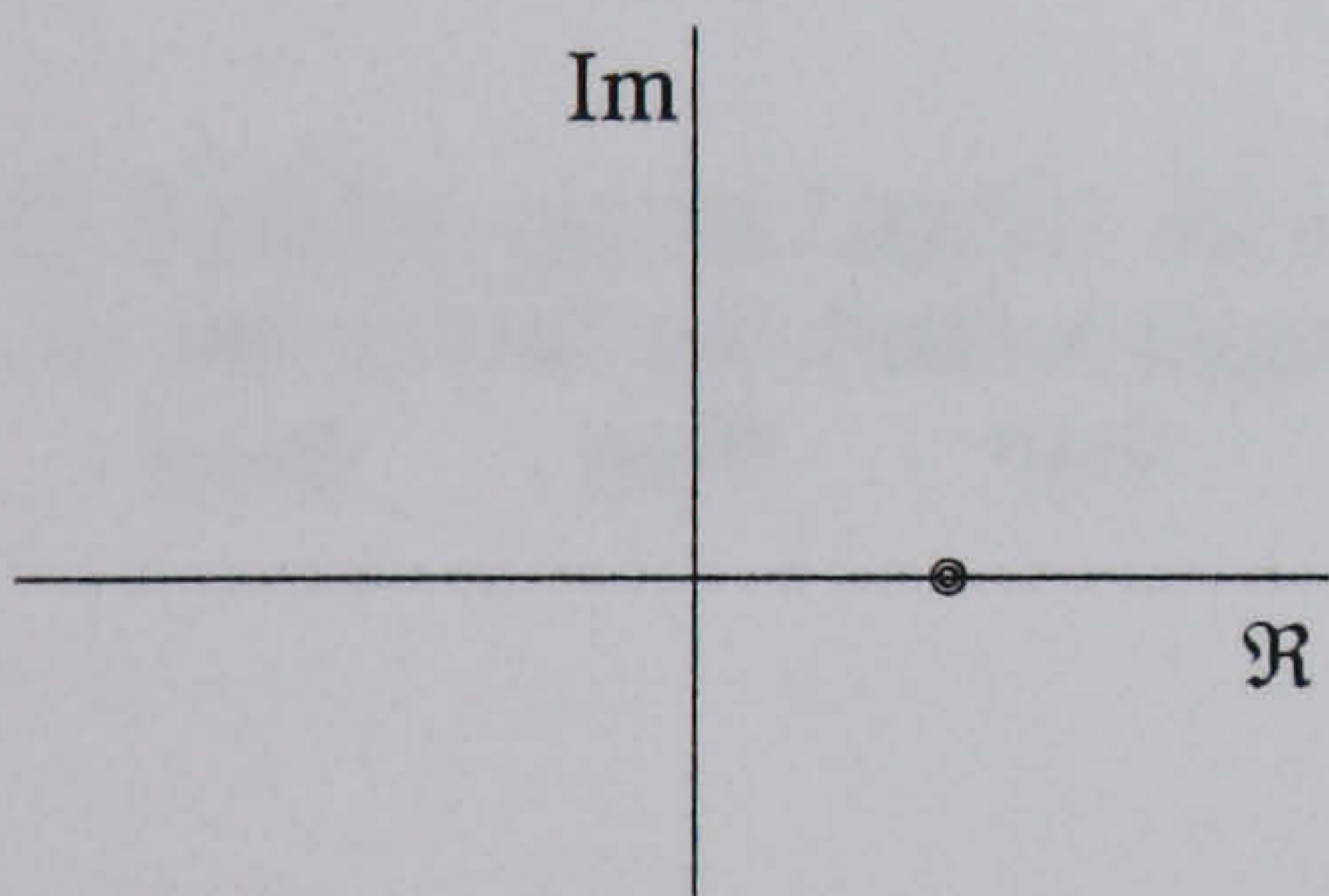

Star (negative attractor)  
 $\eta_1$  and  $\eta_2$  real and distinct eigenvalues  
 $\eta_1=\eta_2=\eta>0$

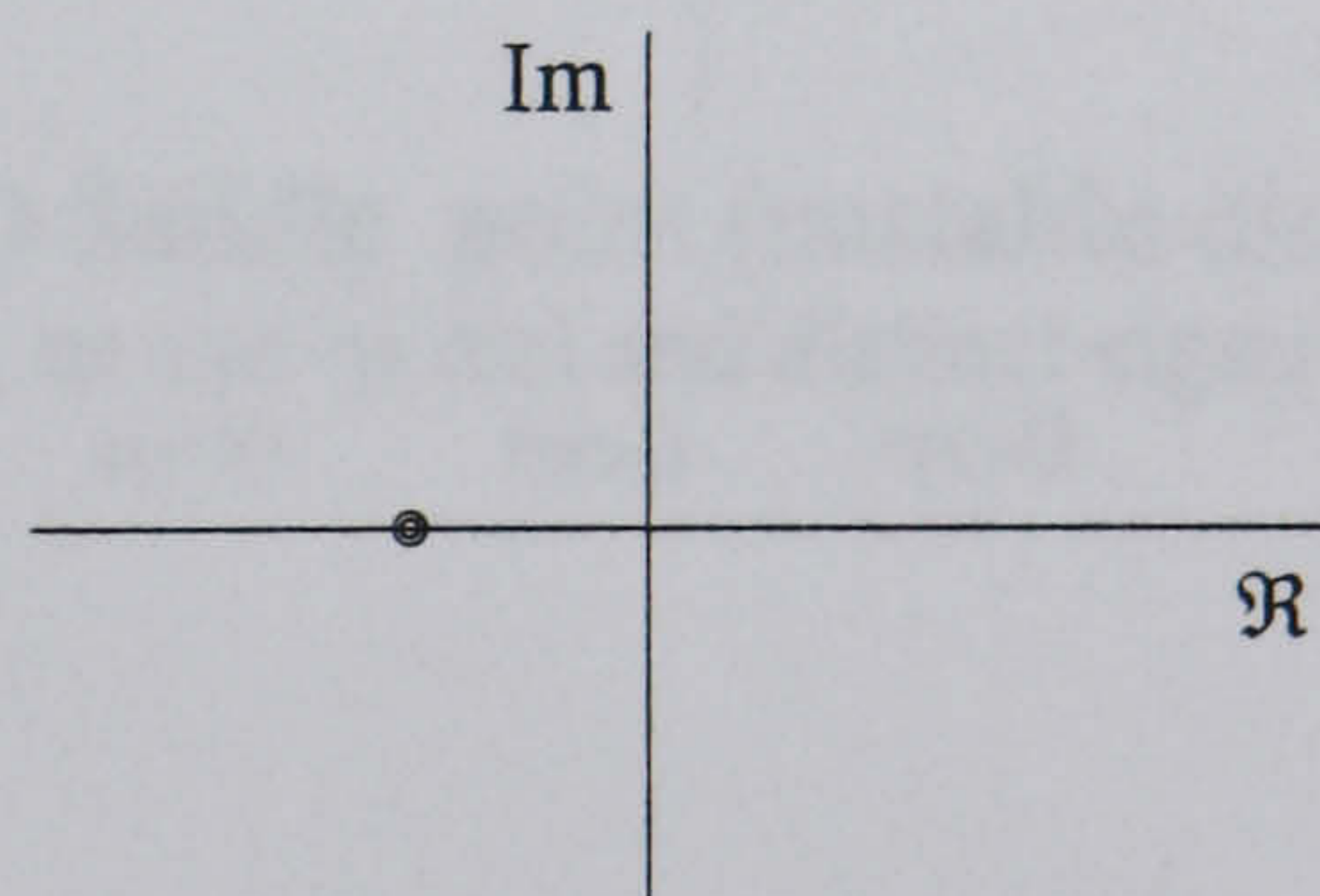

Star (positive attractor)  
 $\eta_1$  and  $\eta_2$  real and distinct eigenvalues  
 $\eta_1=\eta_2=\eta<0$

Fig. 1 b) Eigenvalues diagram for two dimensional linear systems



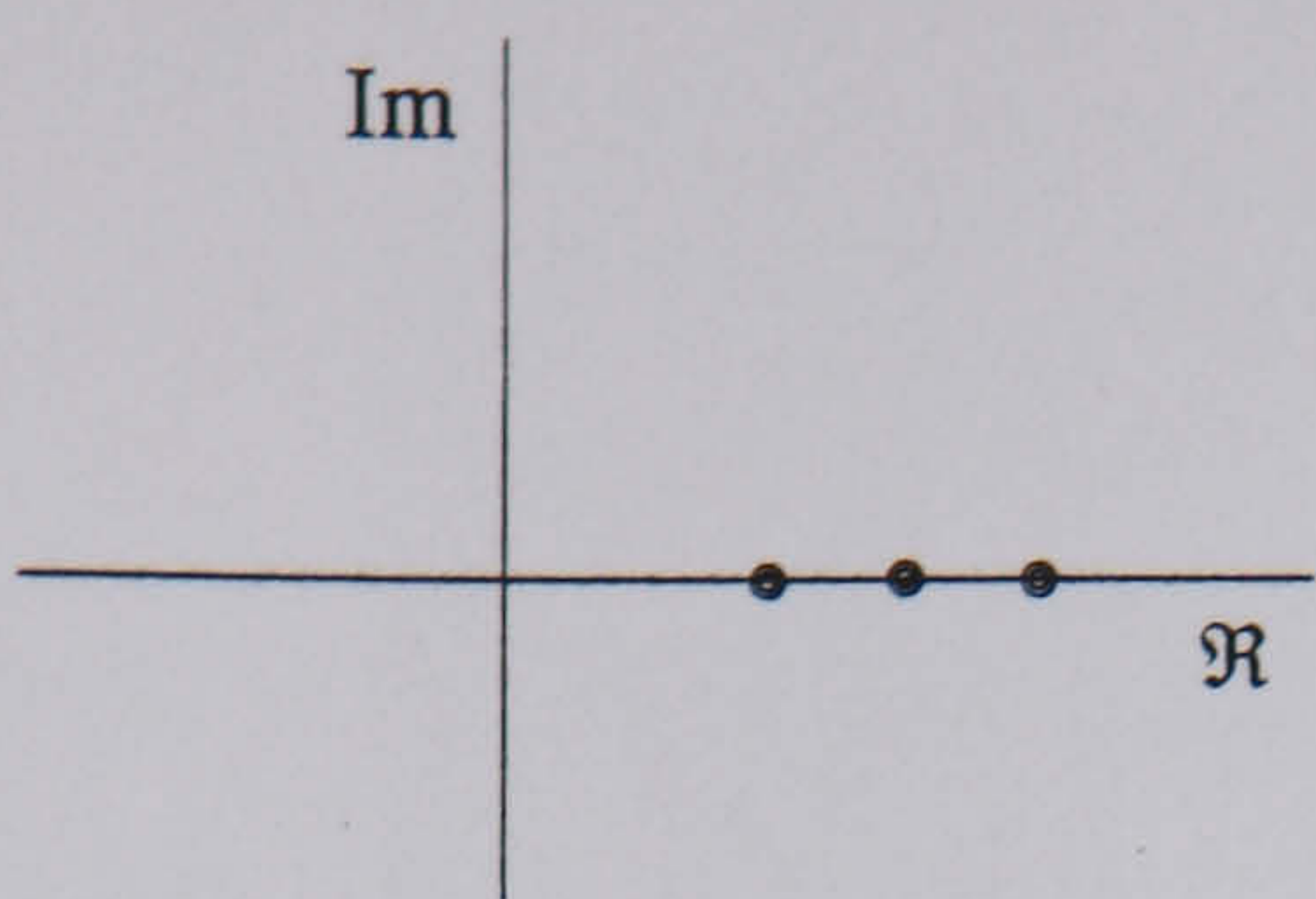

3-D Node (negative attractors)  
 $\eta_1, \eta_2$  and  $\eta_3$  real and distinct eigenvalues  
 $\eta_1 > 0 \quad \eta_2 > 0 \quad \eta_3 > 0$

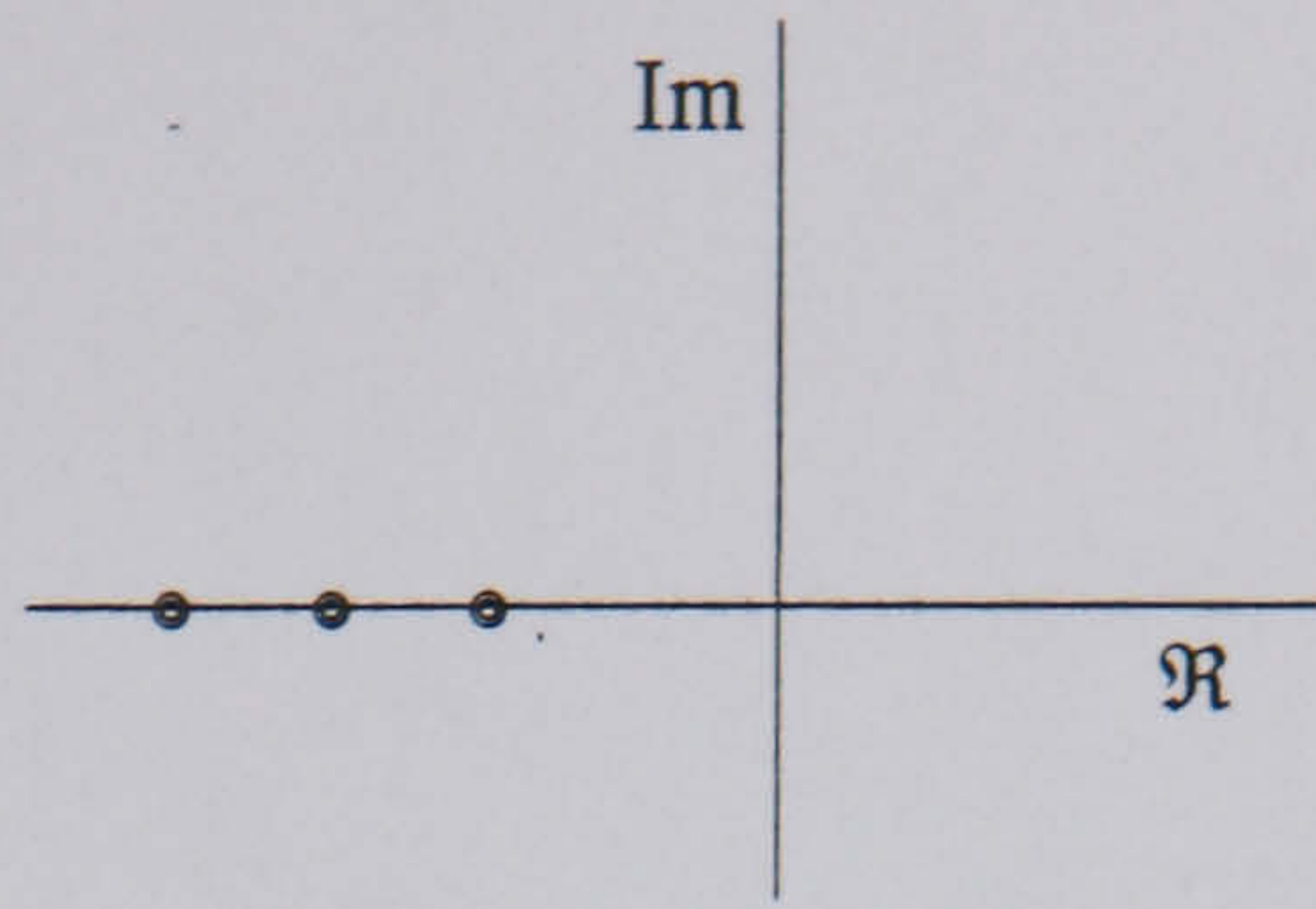

3-D Node (positive attractors)  
 $\eta_1, \eta_2$  and  $\eta_3$  real and distinct eigenvalues  
 $\eta_1 < 0 \quad \eta_2 < 0 \quad \eta_3 < 0$

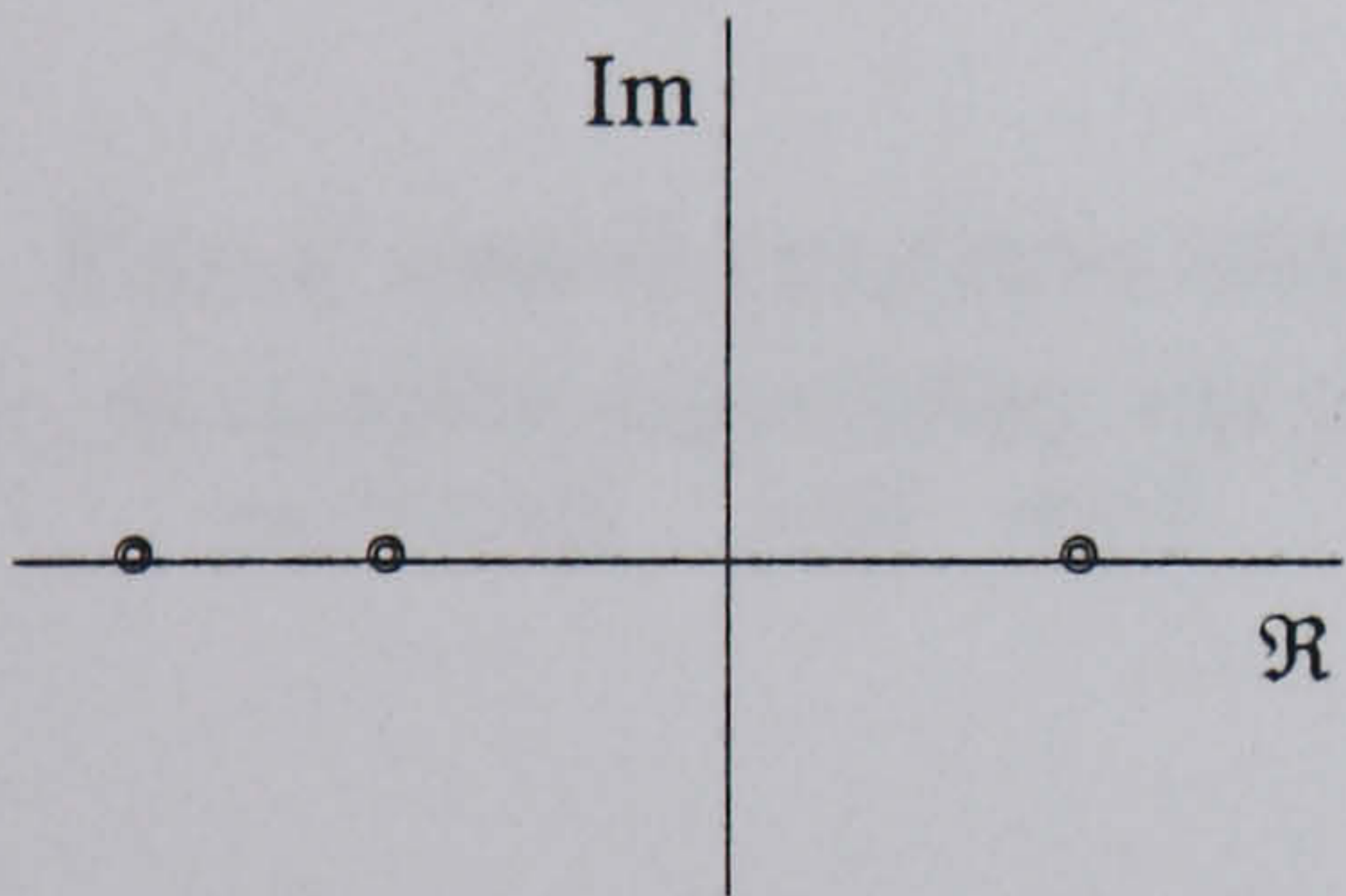

3-D Saddle point (stable direction)  
 $\eta_1, \eta_2$  and  $\eta_3$  real and distinct eigenvalues  
 $\eta_1 < 0 \quad \eta_2 < 0 \quad \eta_3 > 0$

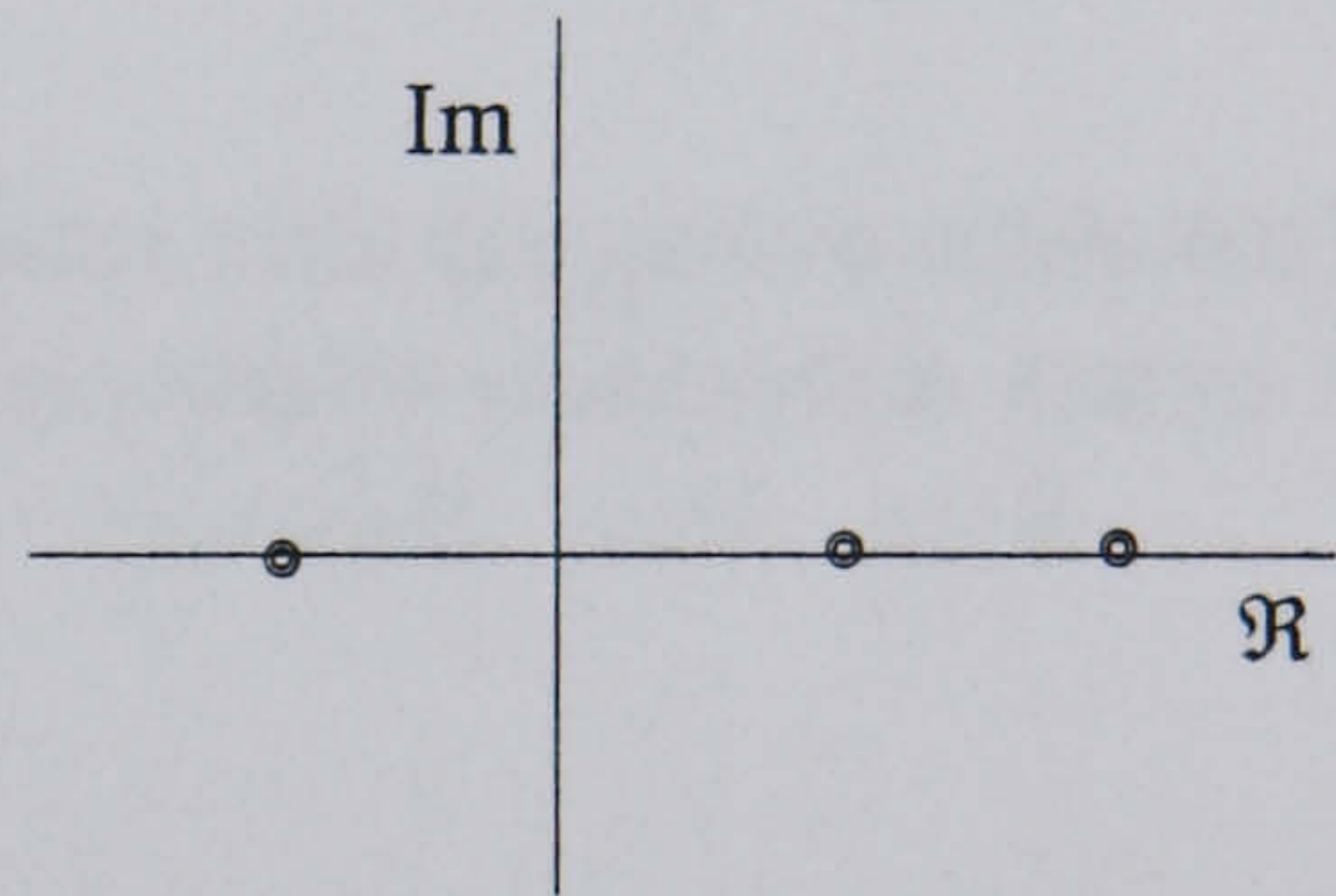

3-D Saddle point (unstable direction)  
 $\eta_1, \eta_2$  and  $\eta_3$  real and distinct eigenvalues  
 $\eta_1 < 0 \quad \eta_2 > 0 \quad \eta_3 > 0$

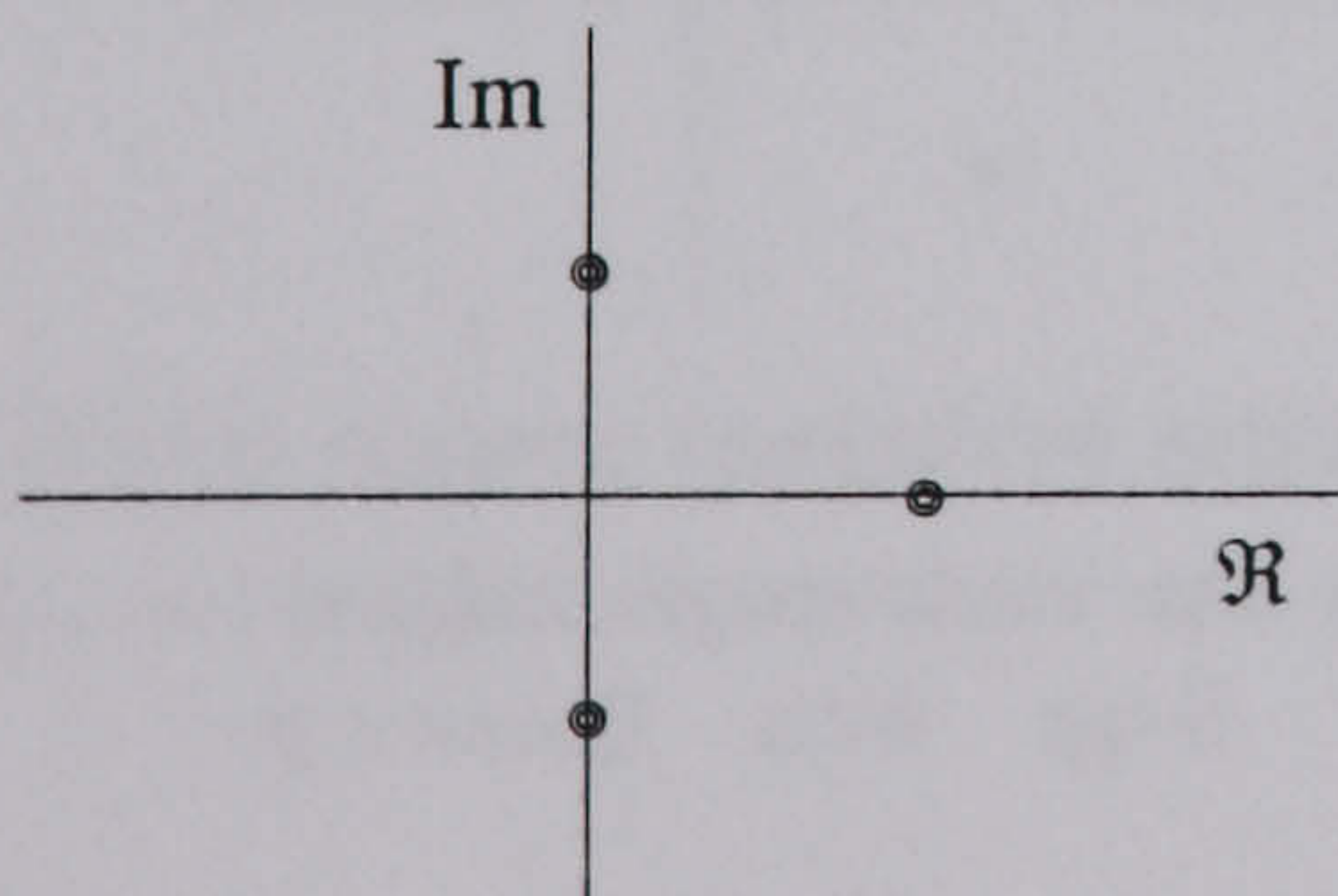

3-D Centre (negative attractor)  
 $\eta_1, \eta_2$  complex eigenvalues and  $\eta_3$  real  
 $\eta_{1,2} = \pm i\beta \quad \eta_3 > 0$

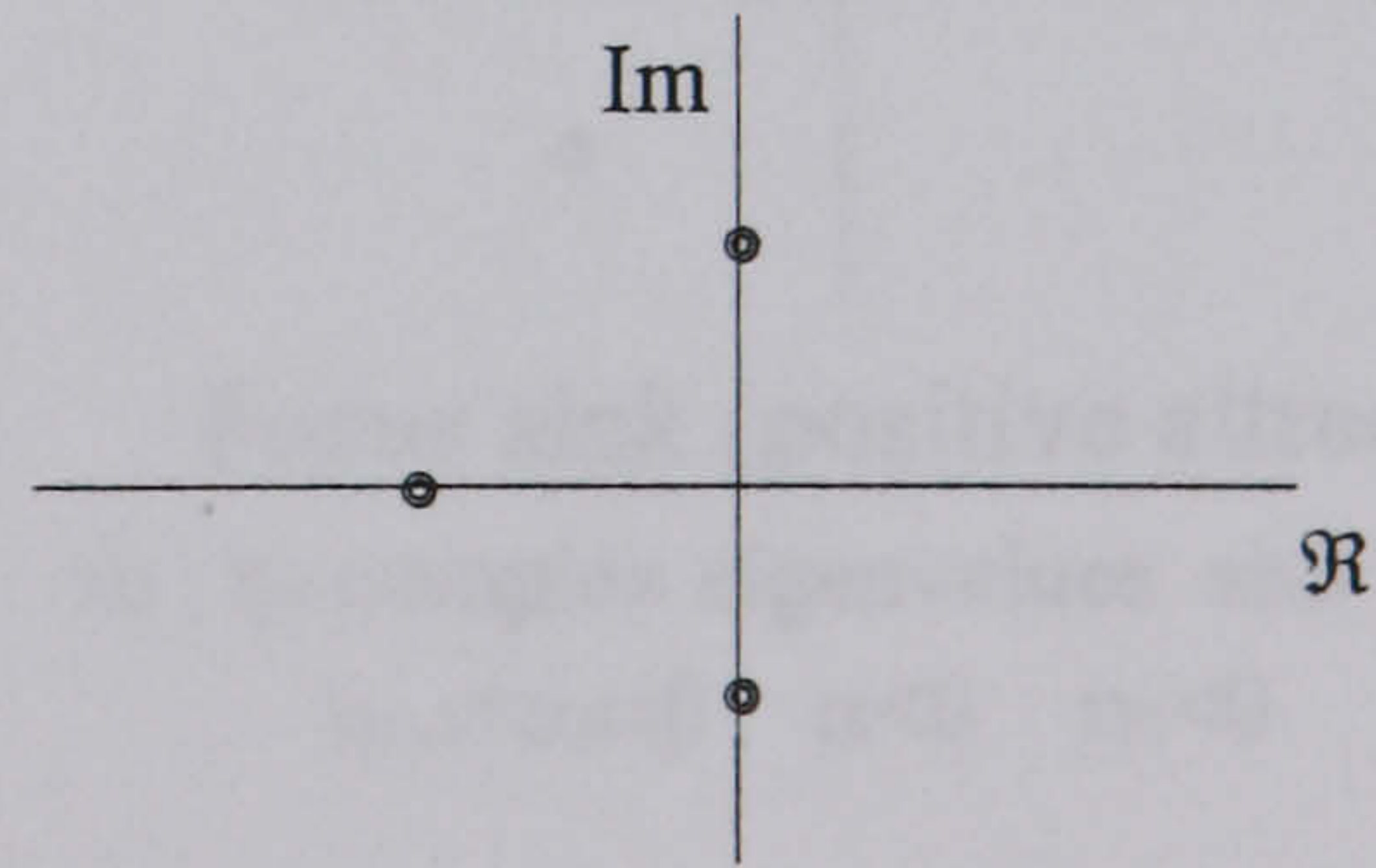

3-D Centre (positive attractor)  
 $\eta_1, \eta_2$  complex eigenvalues and  $\eta_3$  real  
 $\eta_{1,2} = \pm i\beta \quad \eta_3 < 0$

Fig. 2 a) Eigenvalues diagram for three dimensional linear systems



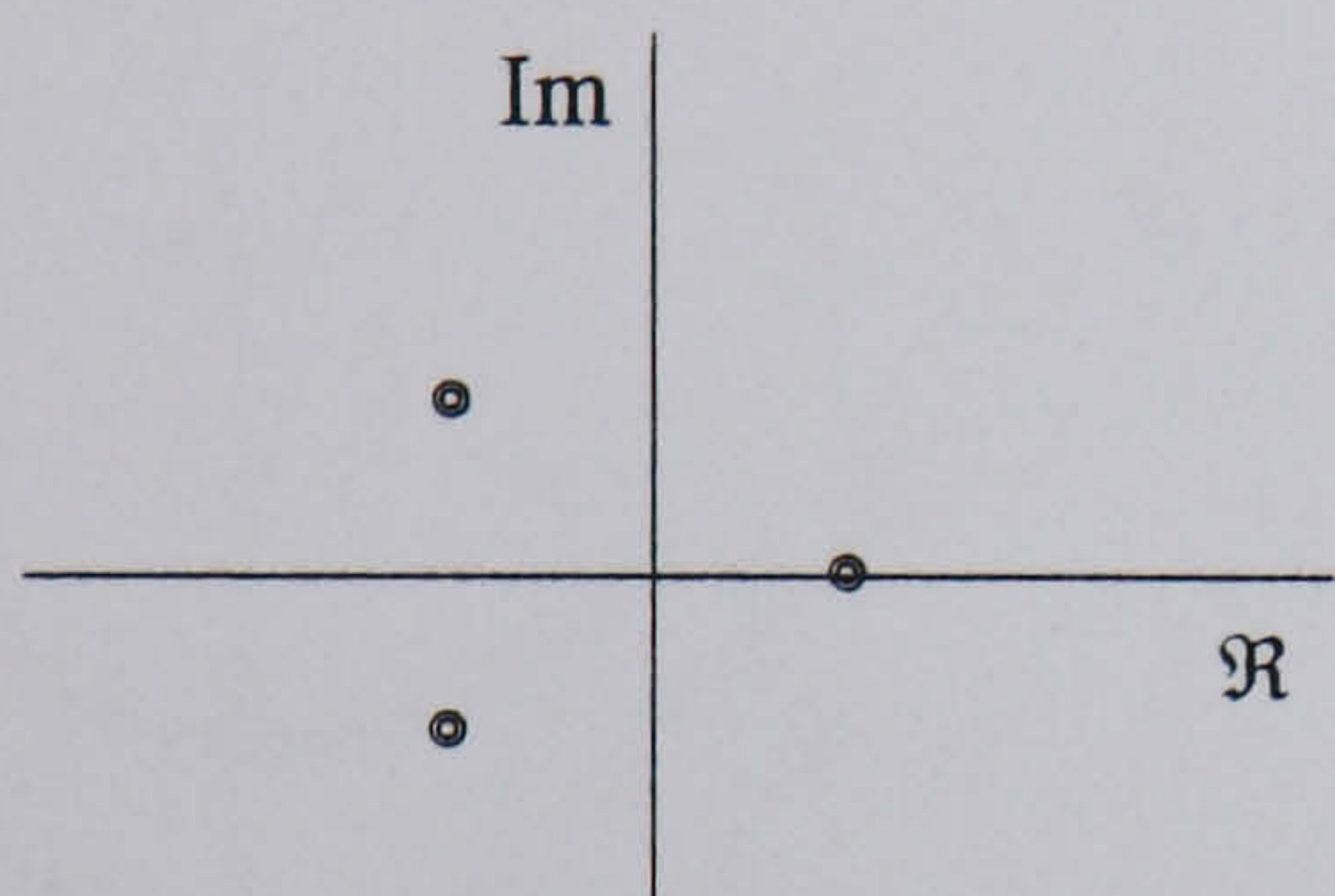

Focus source (positive attractor)  
 $\eta_1, \eta_2$  complex eigenvalues and  $\eta_3$  real  
 $\eta_{1,2} = \alpha \pm i\beta$   $\alpha < 0$   $\eta_3 > 0$

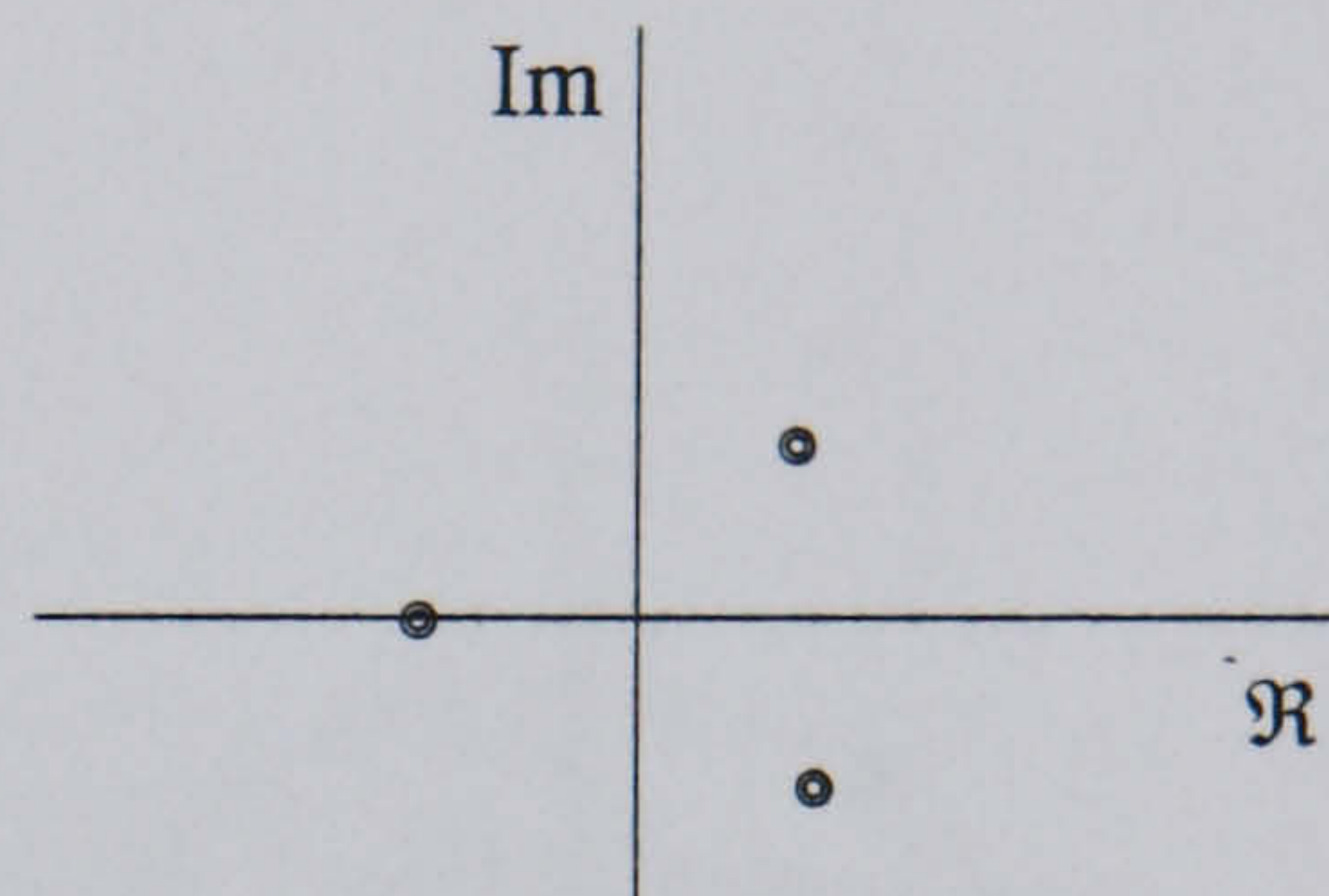

Focus sink (negative attractor)  
 $\eta_1, \eta_2$  complex eigenvalues and  $\eta_3$  real  
 $\eta_{1,2} = \alpha \pm i\beta$   $\alpha > 0$   $\eta_3 < 0$

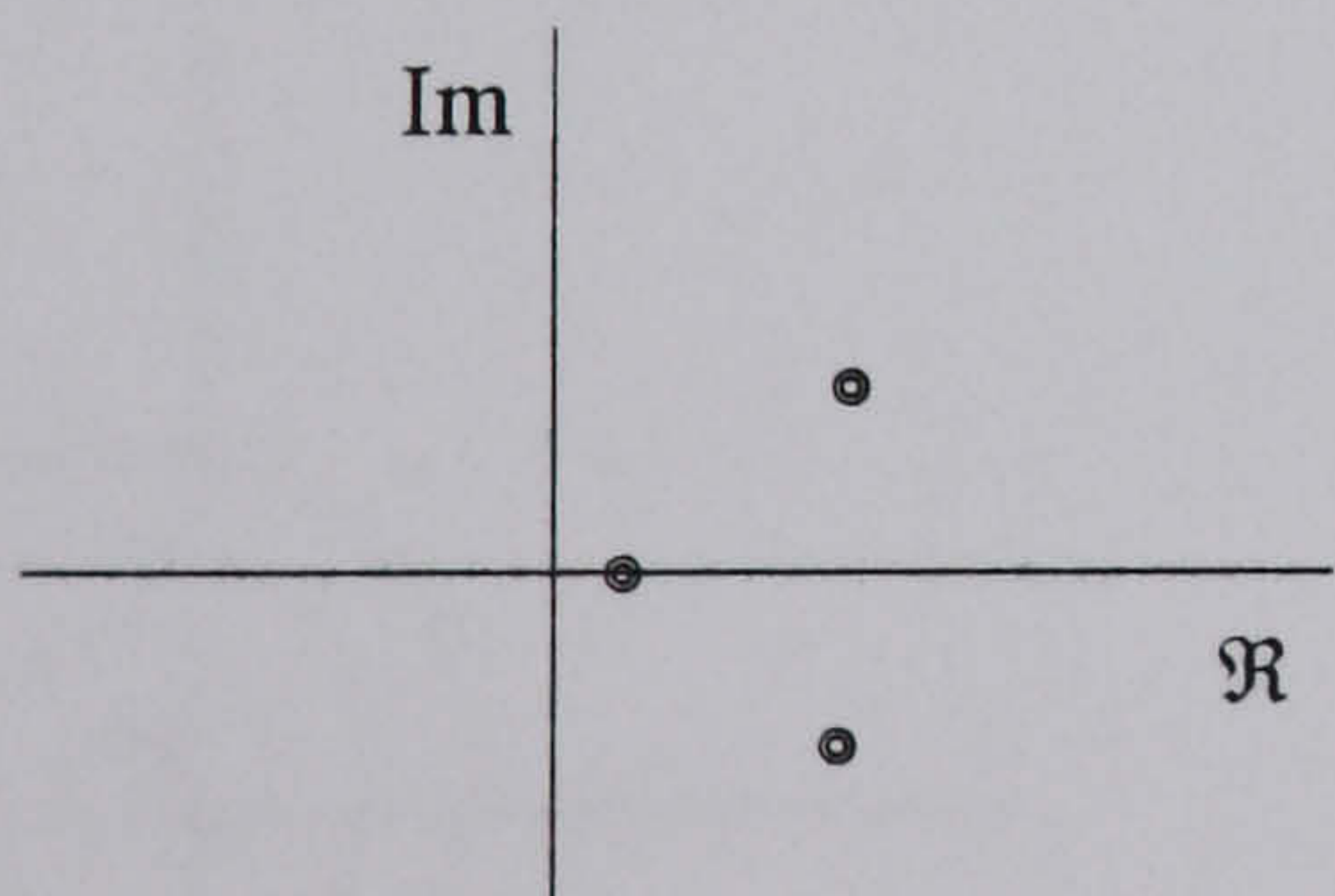

Focus source (negative attractor)  
 $\eta_1, \eta_2$  complex eigenvalues and  $\eta_3$  real  
 $\eta_{1,2} = \alpha \pm i\beta$   $\alpha > 0$   $\eta_3 > 0$

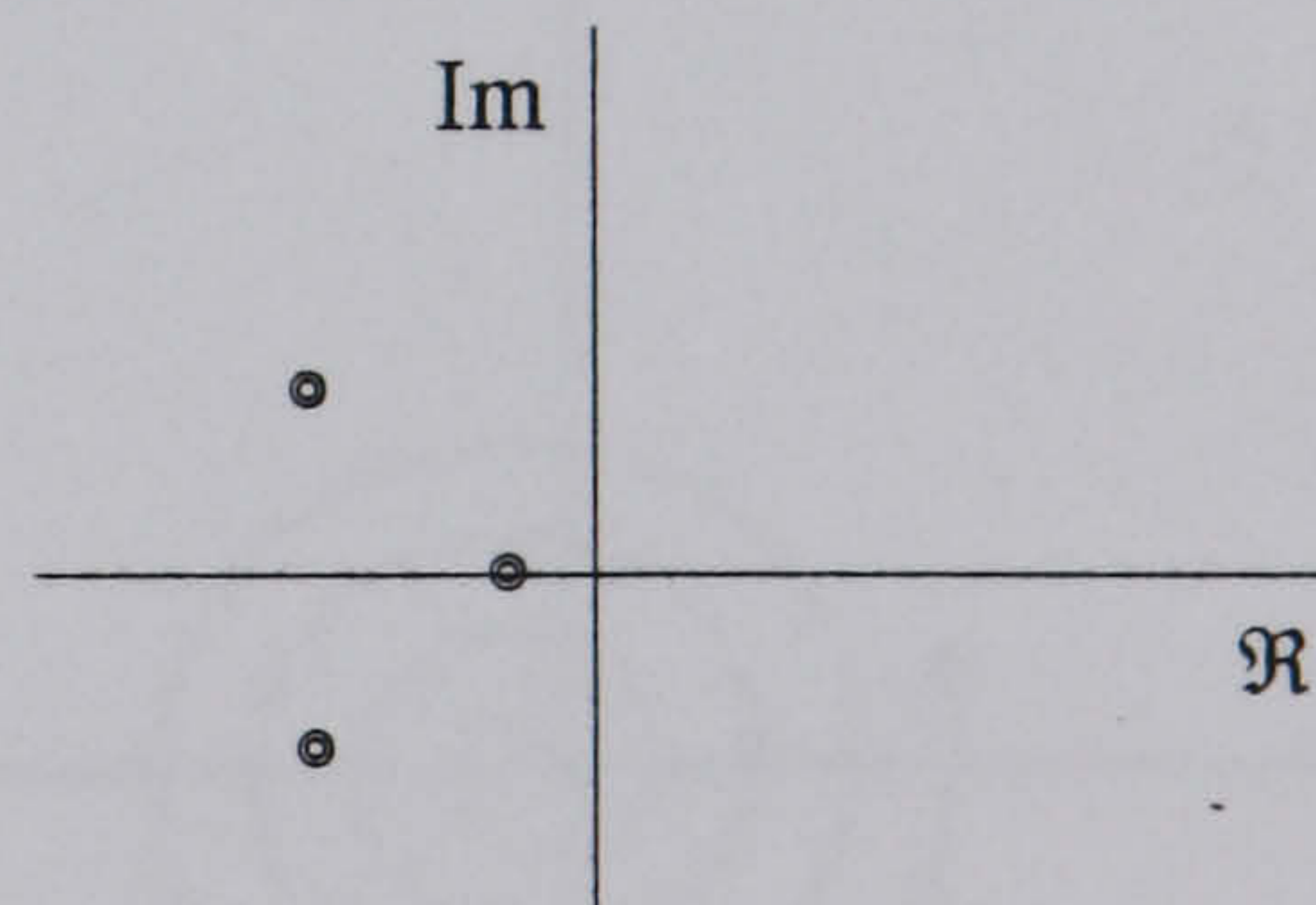

Focus sink (positive attractor)  
 $\eta_1, \eta_2$  complex eigenvalues and  $\eta_3$  real  
 $\eta_{1,2} = \alpha \pm i\beta$   $\alpha < 0$   $\eta_3 < 0$

Fig. 2 b) Eigenvalues diagram for three dimensional linear systems



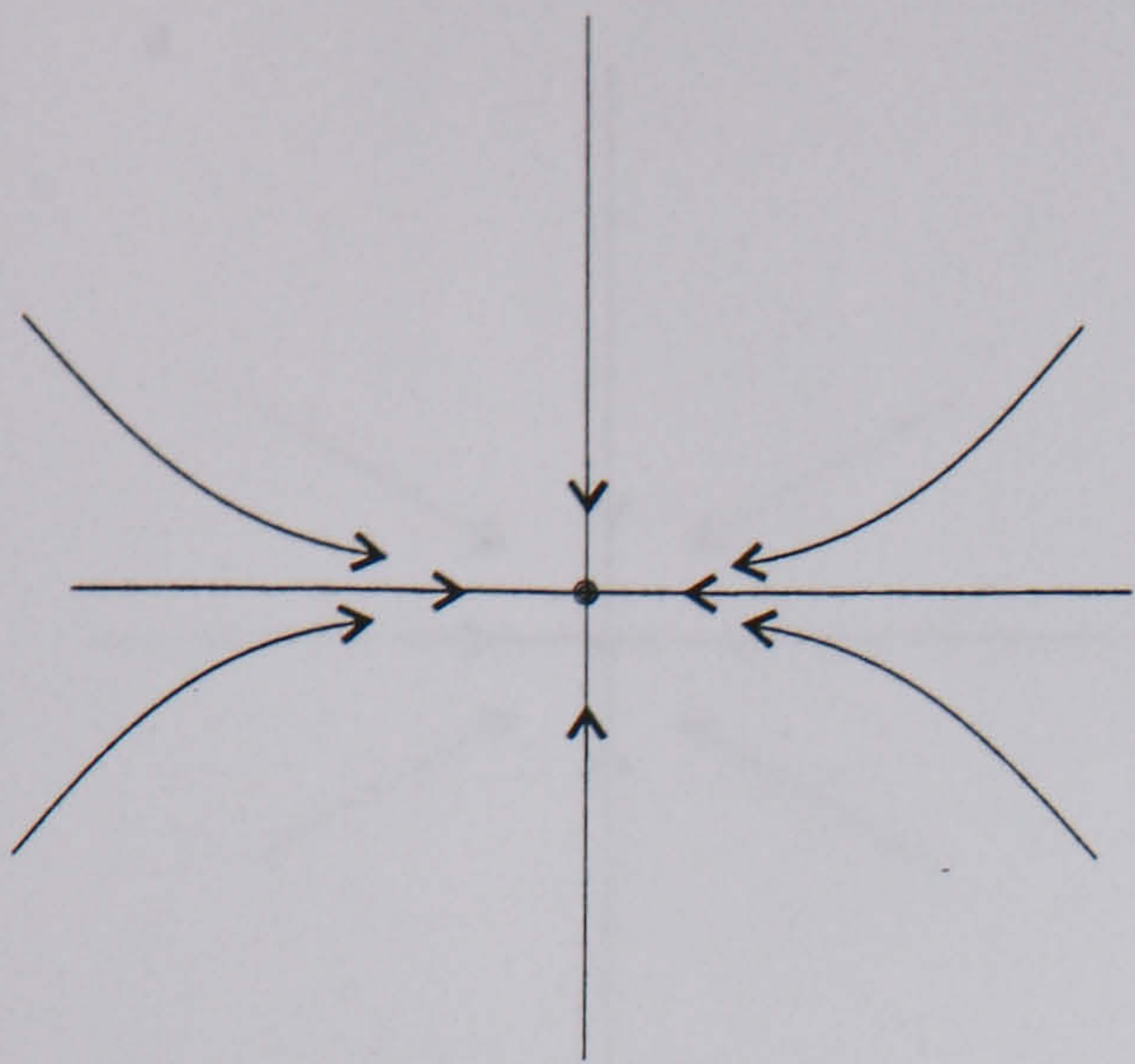

Node (positive attractor)

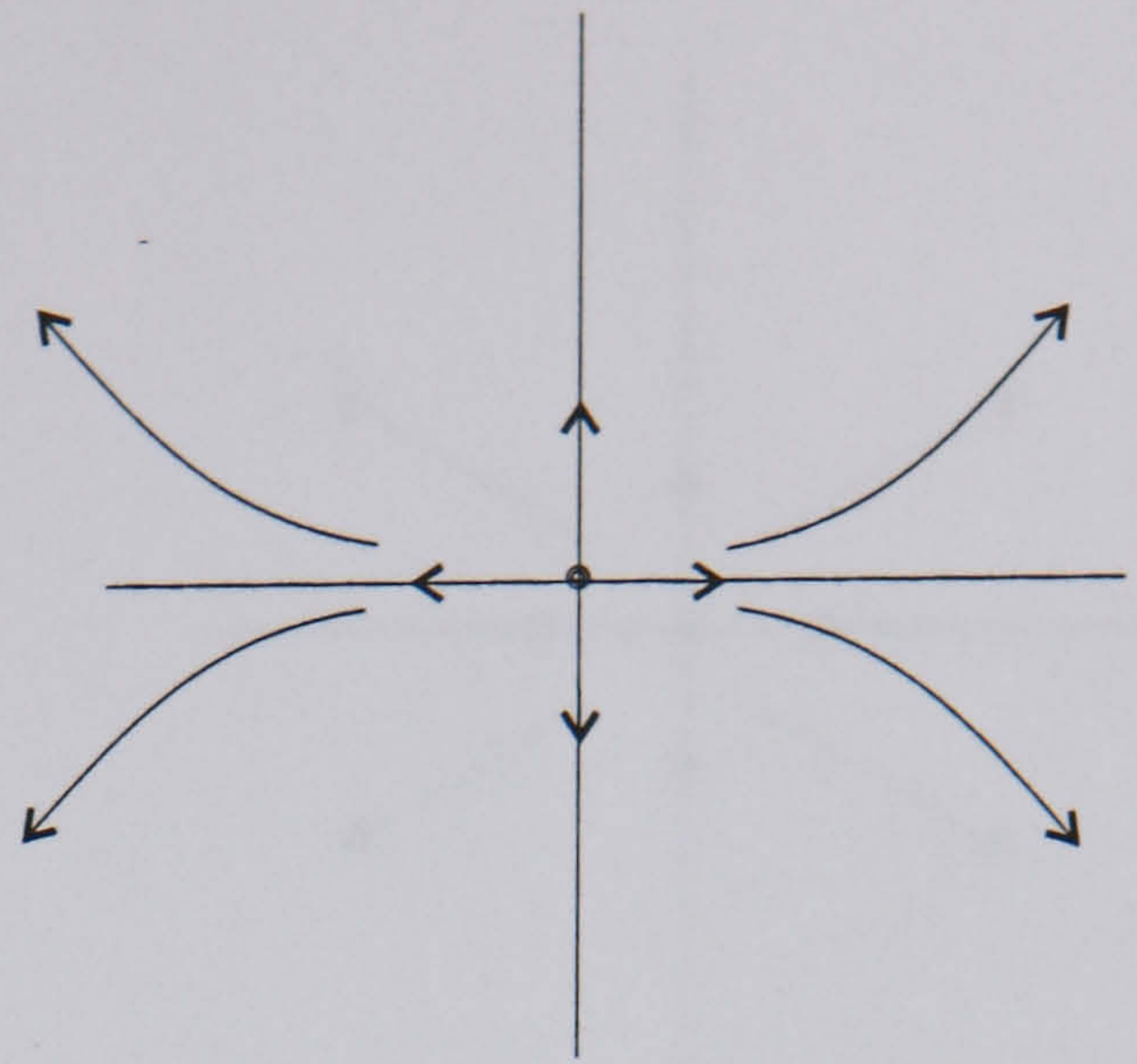

Node (negative attractor)

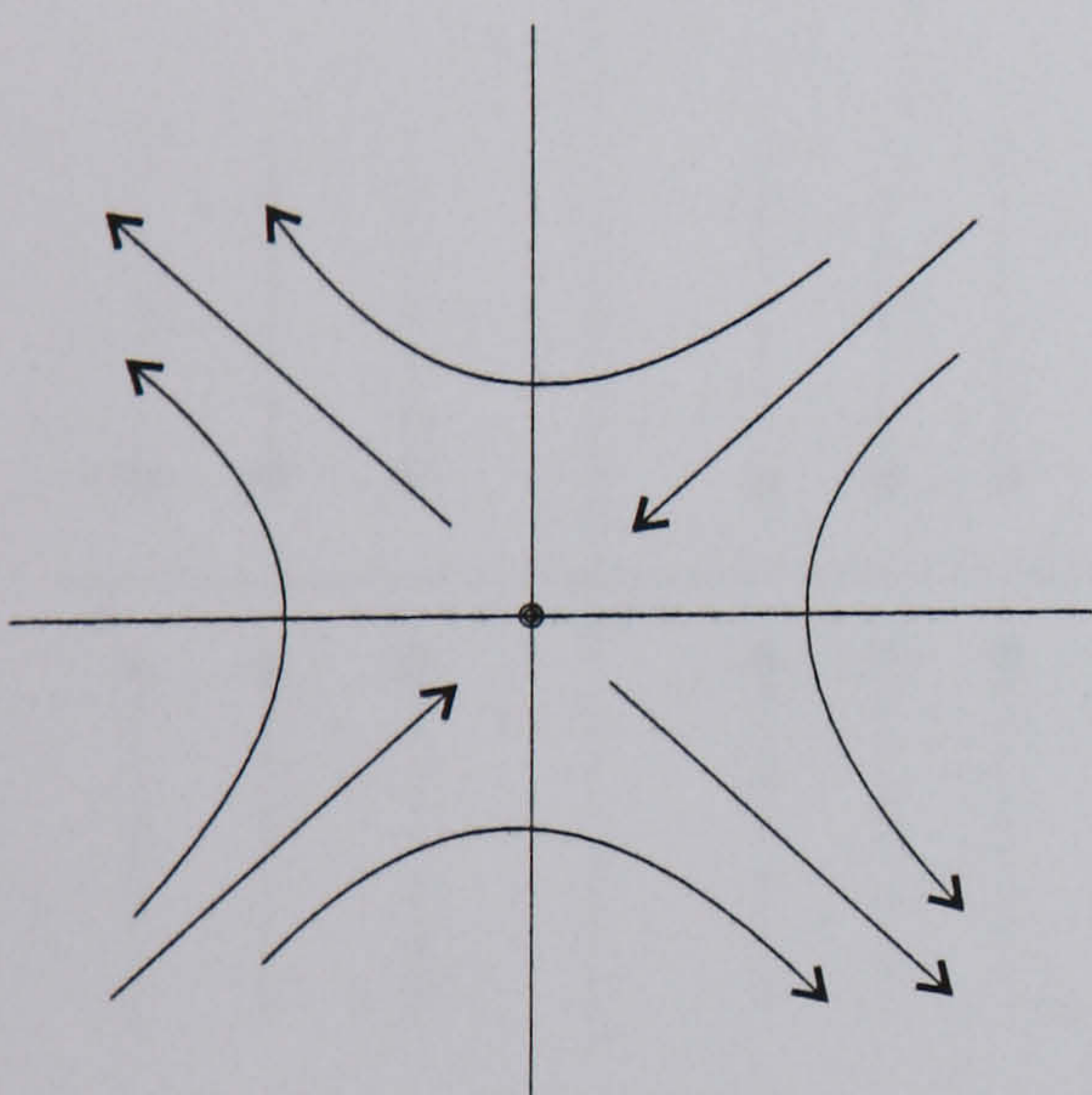

Saddle point

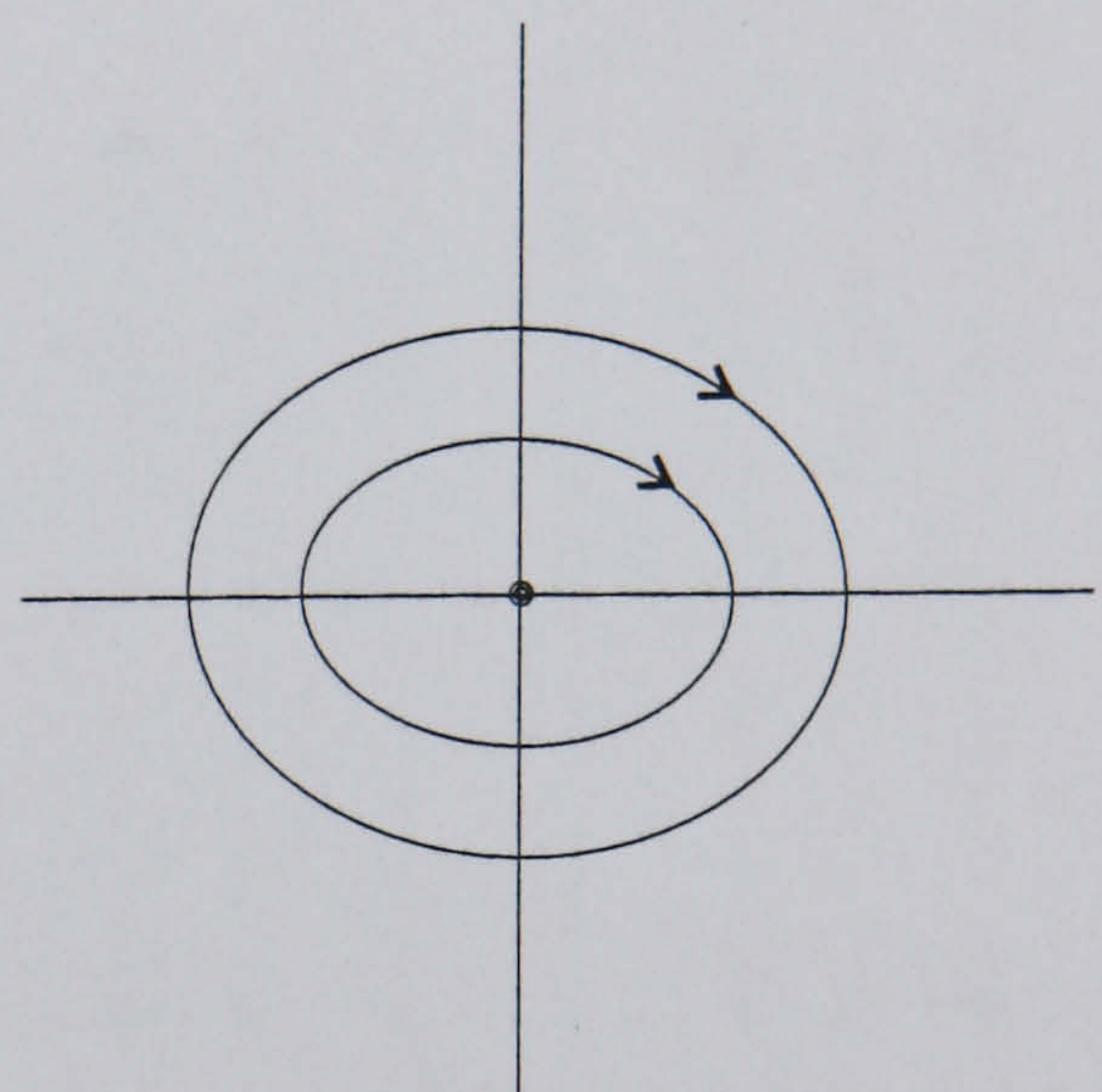

Centre

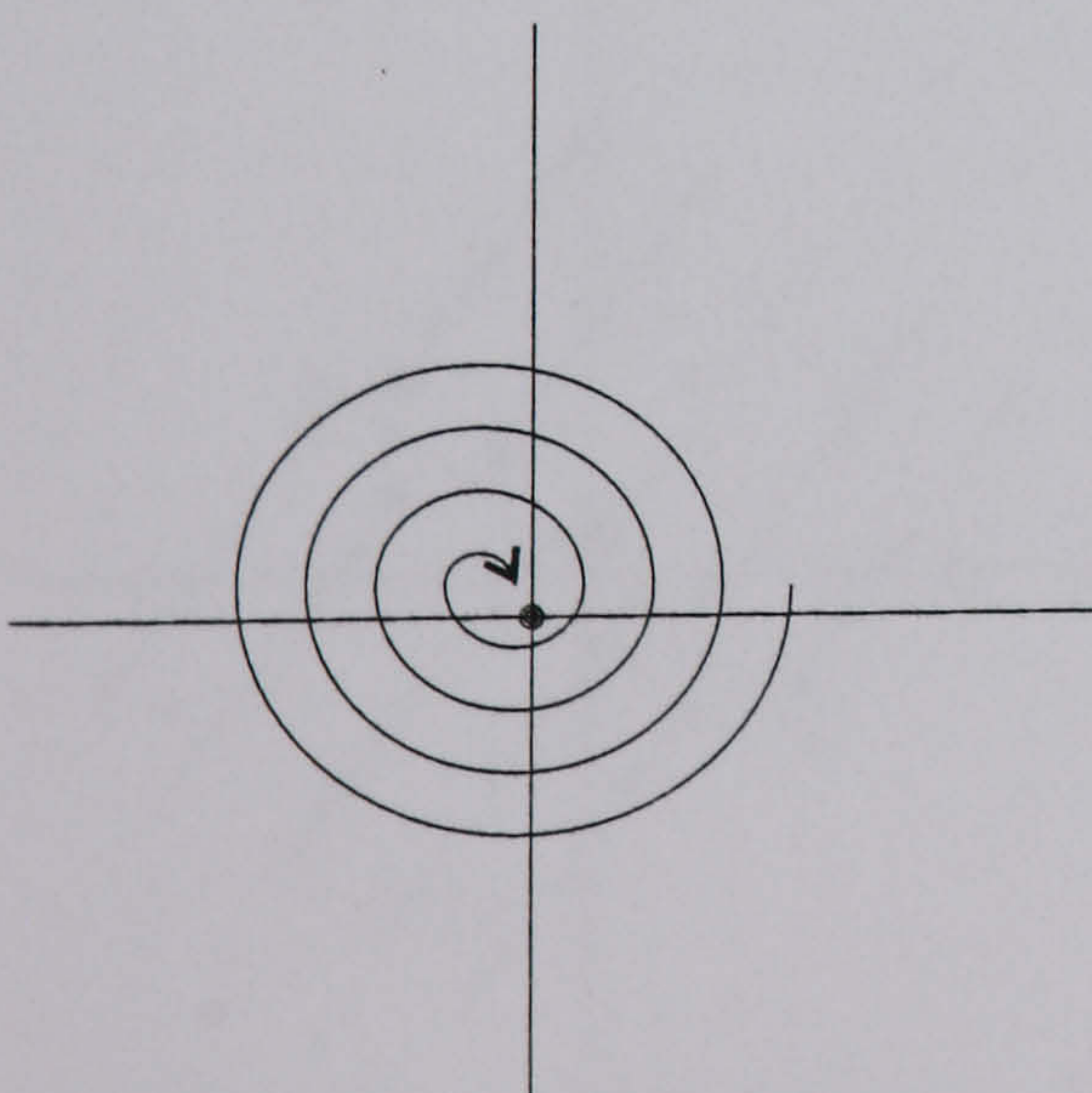

Focus sink

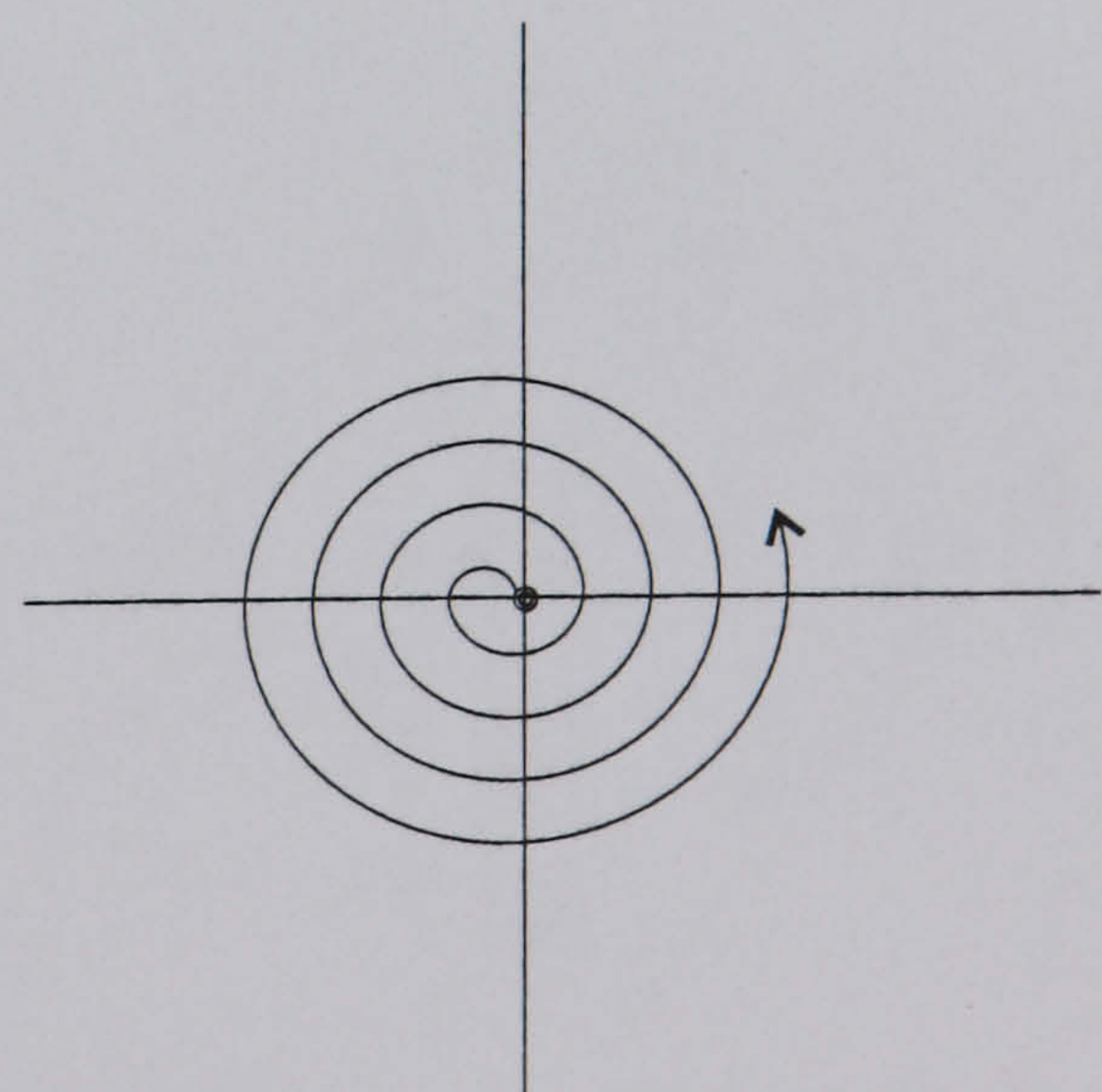

Focus source

Fig. 3 a) Phase-plane diagrams for two dimensional systems



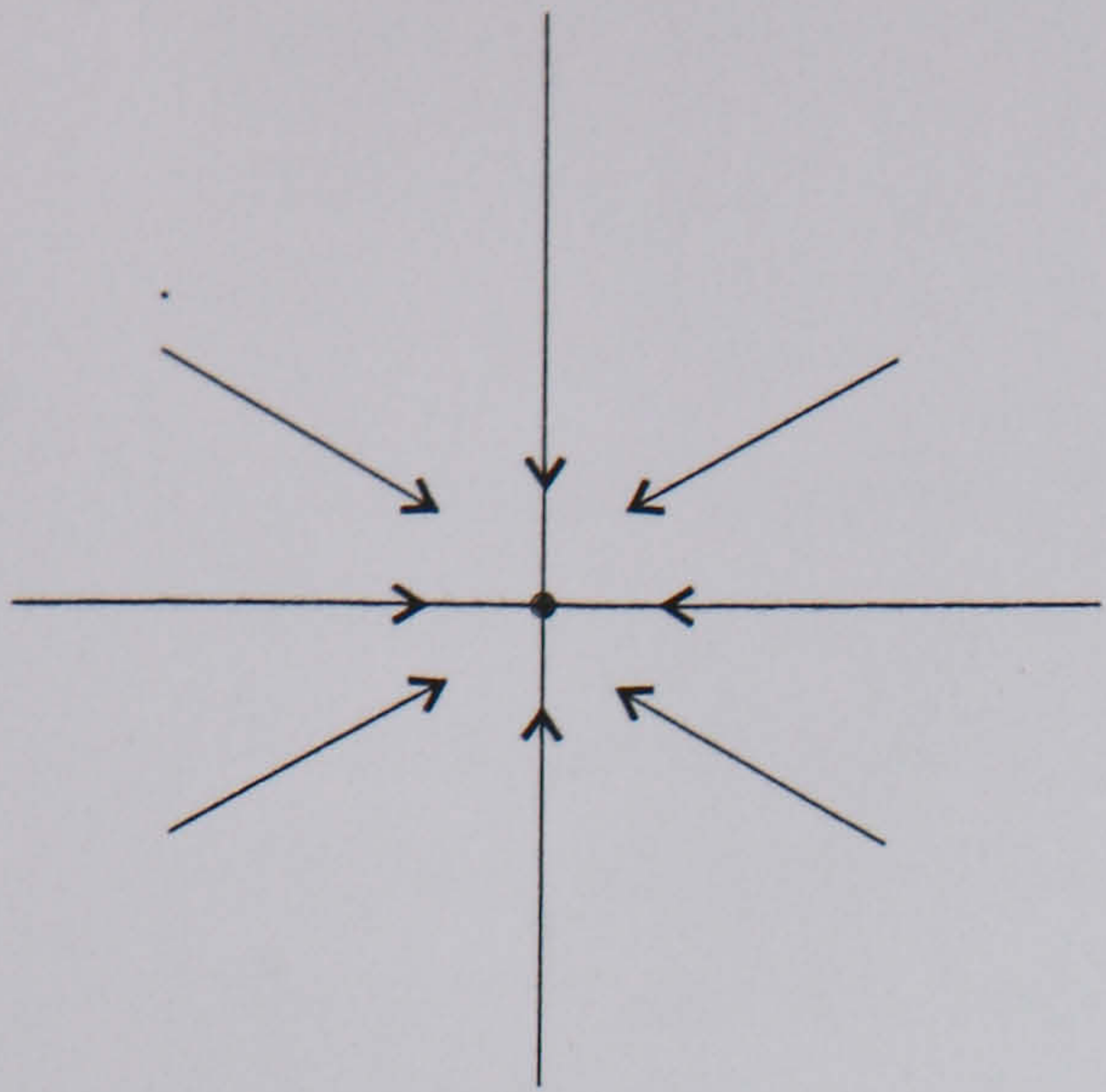

Star (positive attractor)

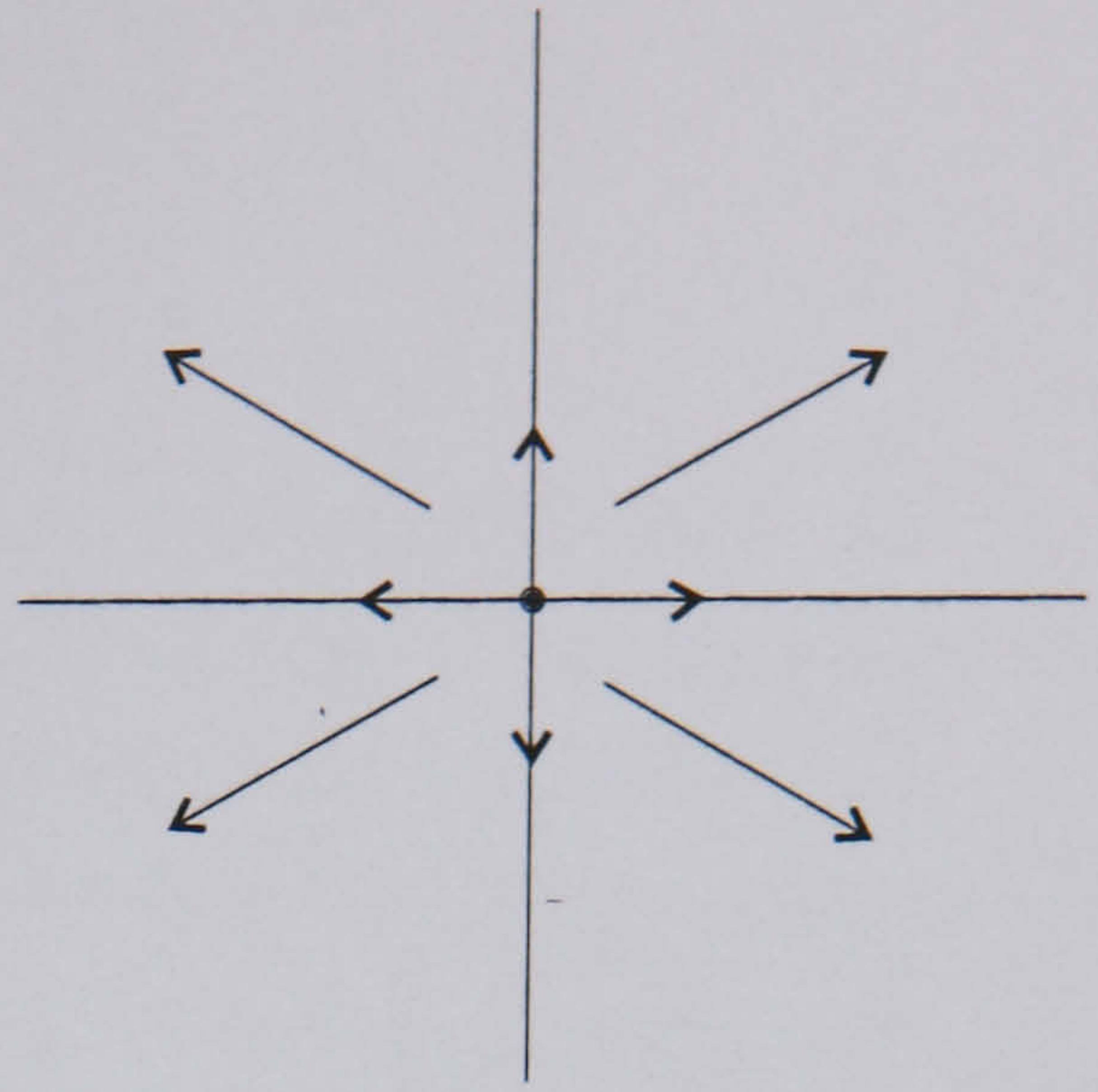

Star (negative attractor)

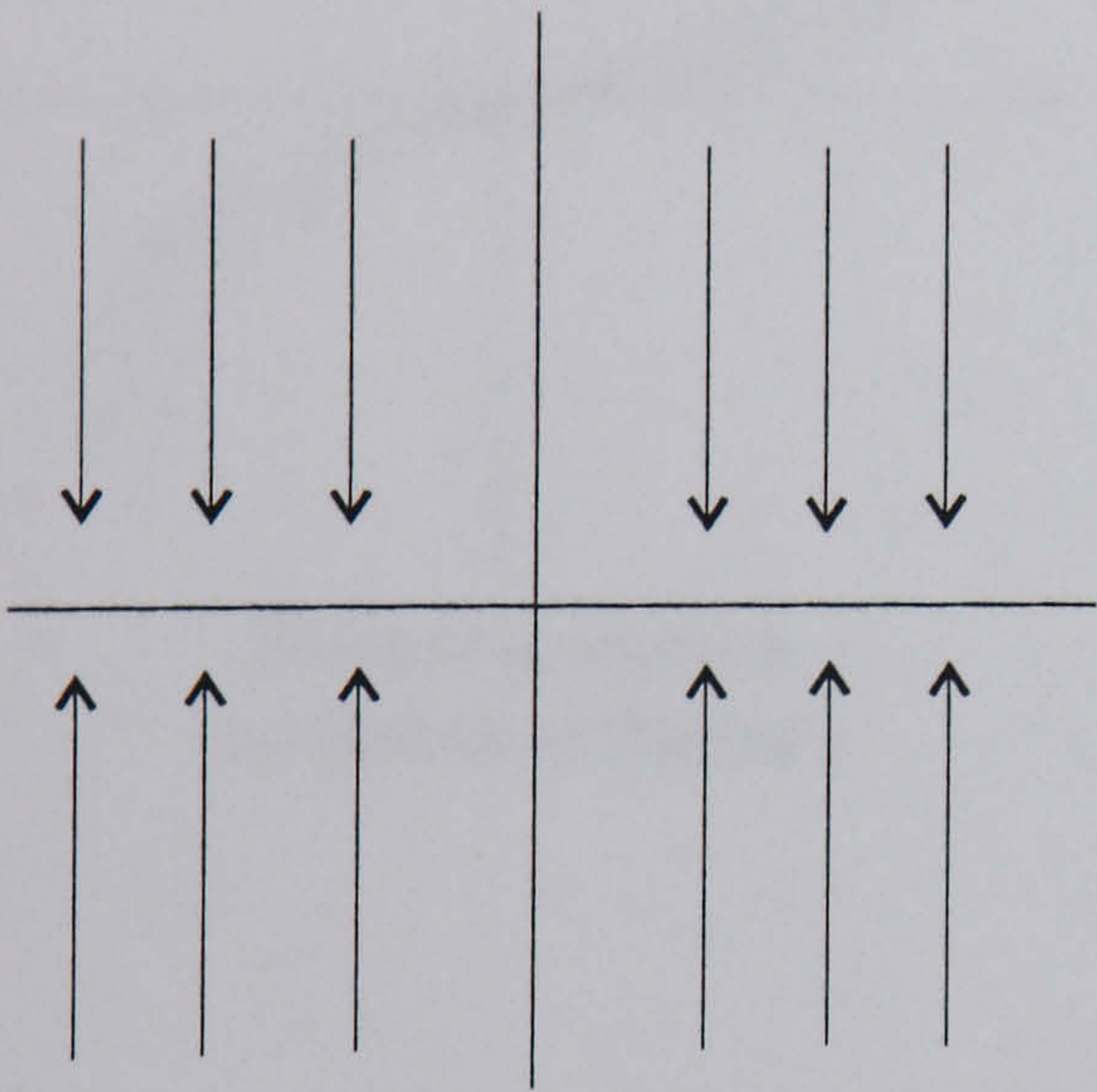

Line of equilibria  
(positive attractor)

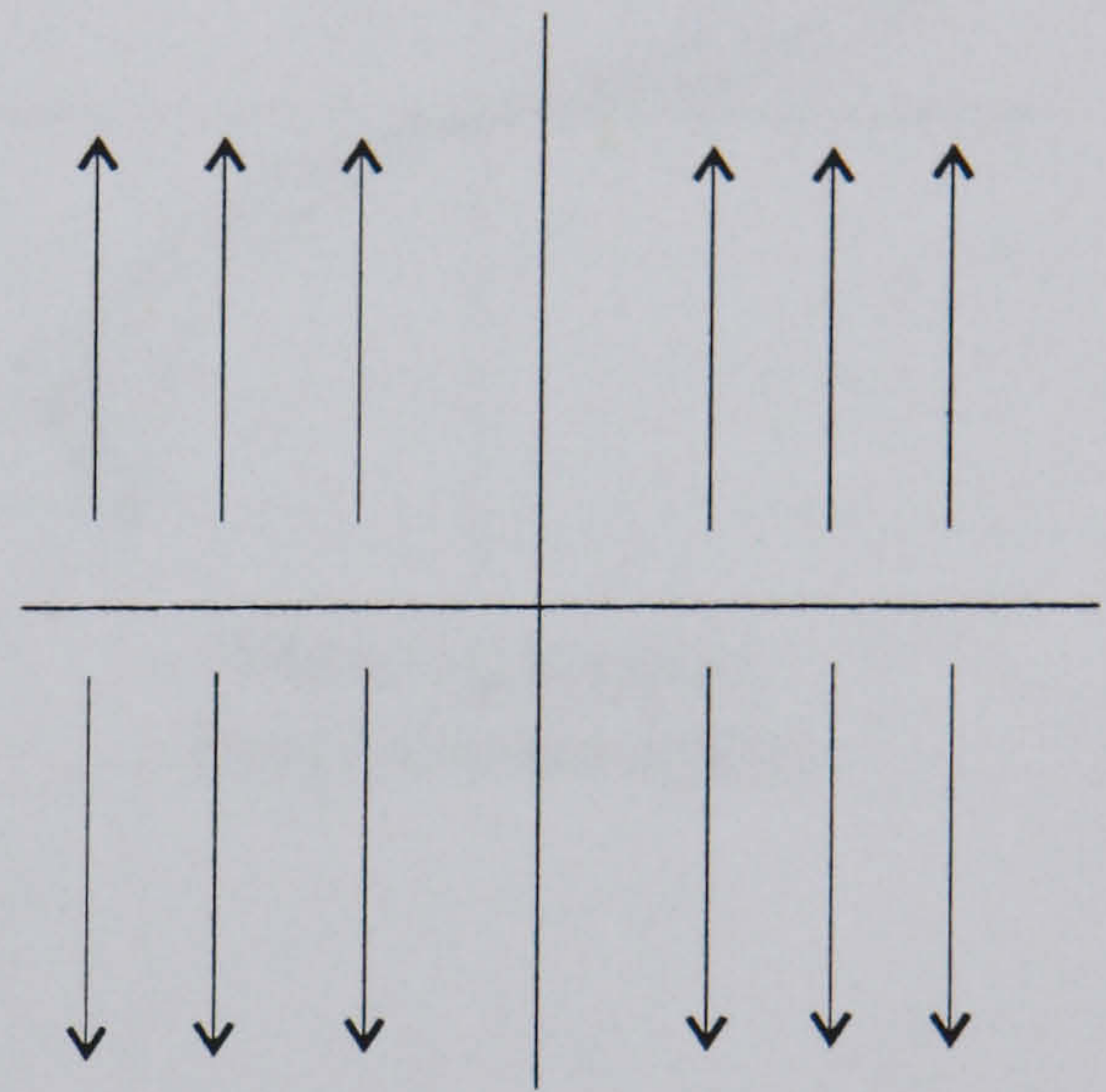

Line of equilibria  
(negative attractor)

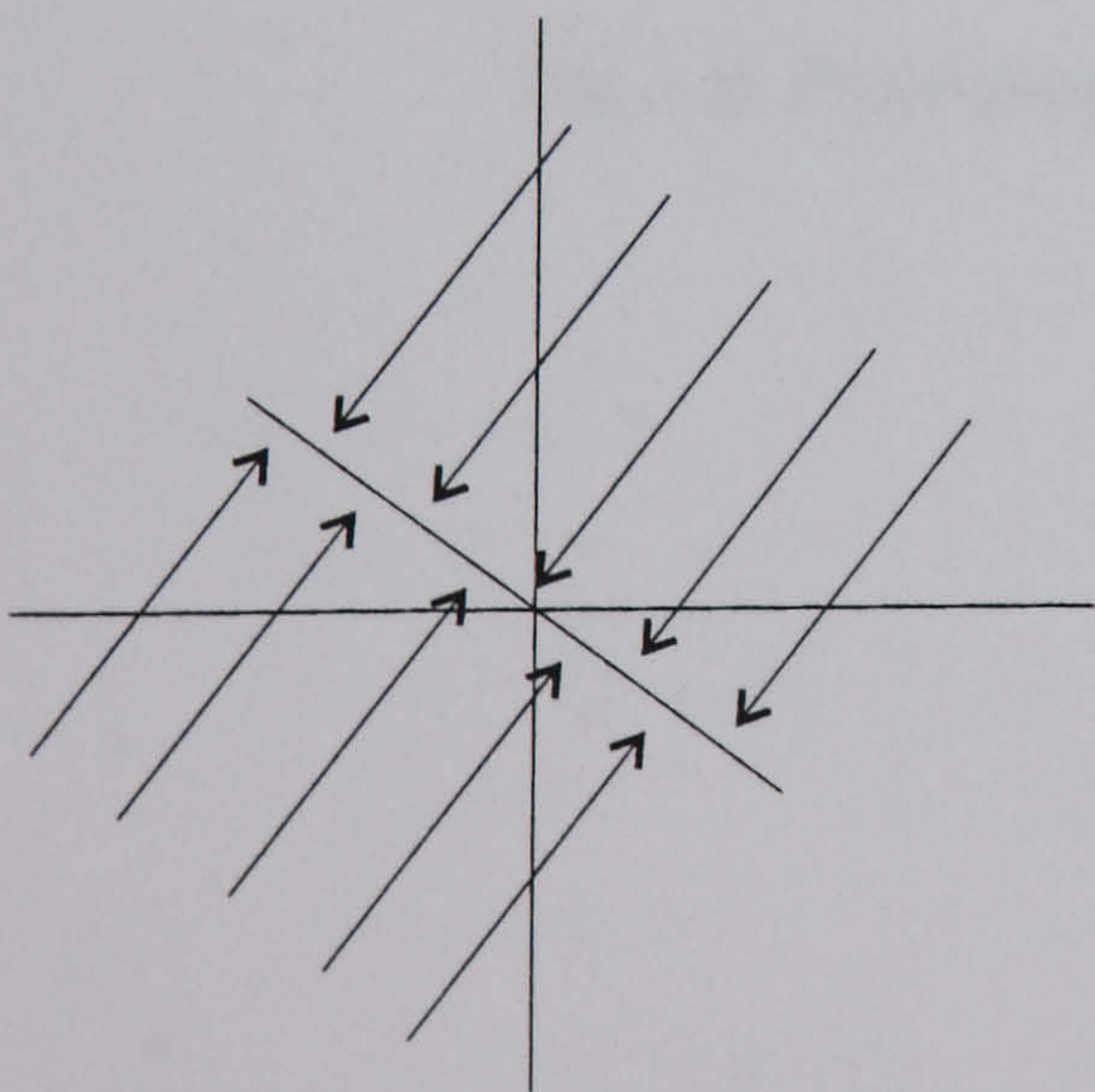

Shearing motion on axis

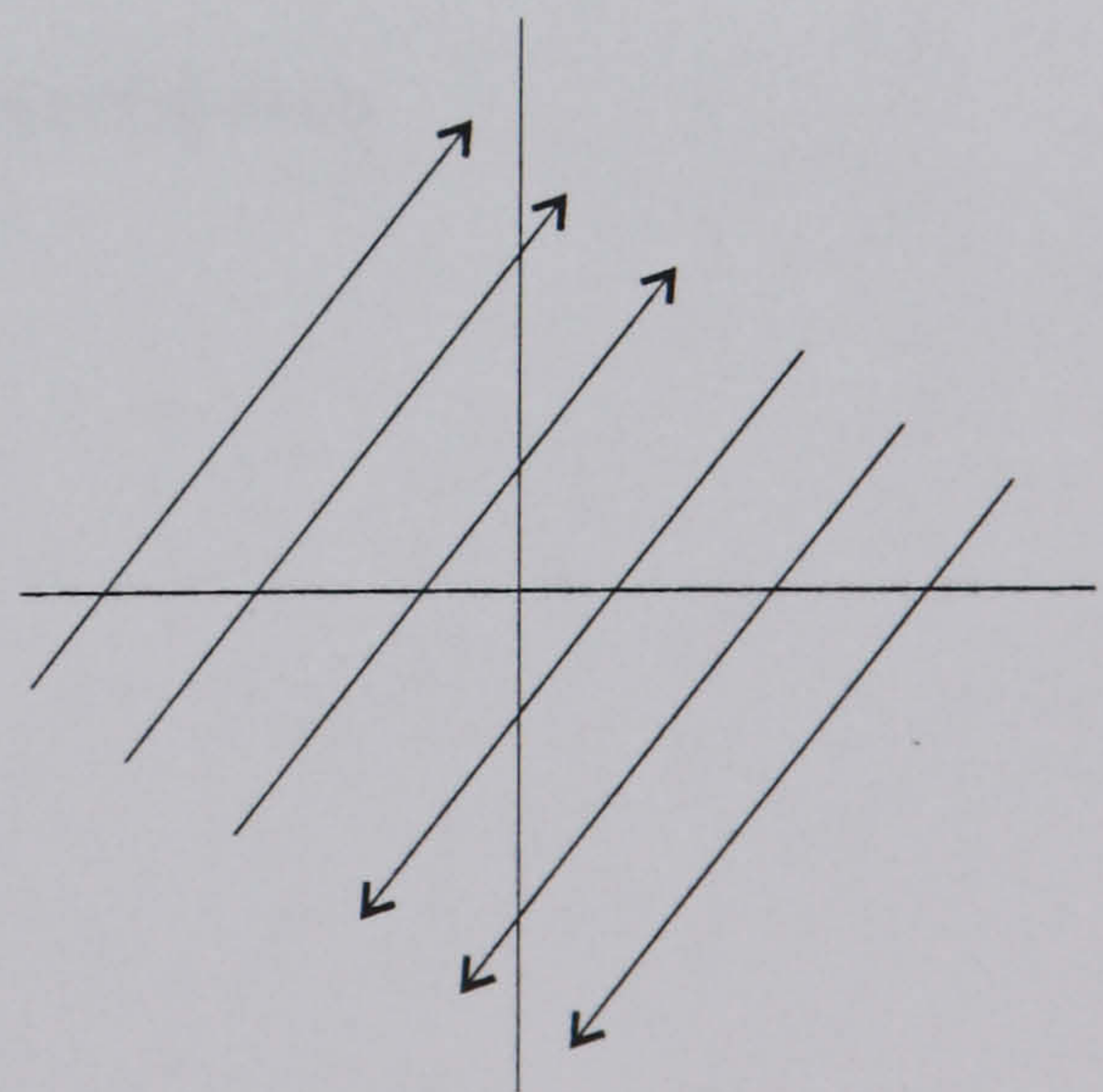

Shearing motion at origin

Fig. 3 b) Phase-plane diagrams for two dimensional systems



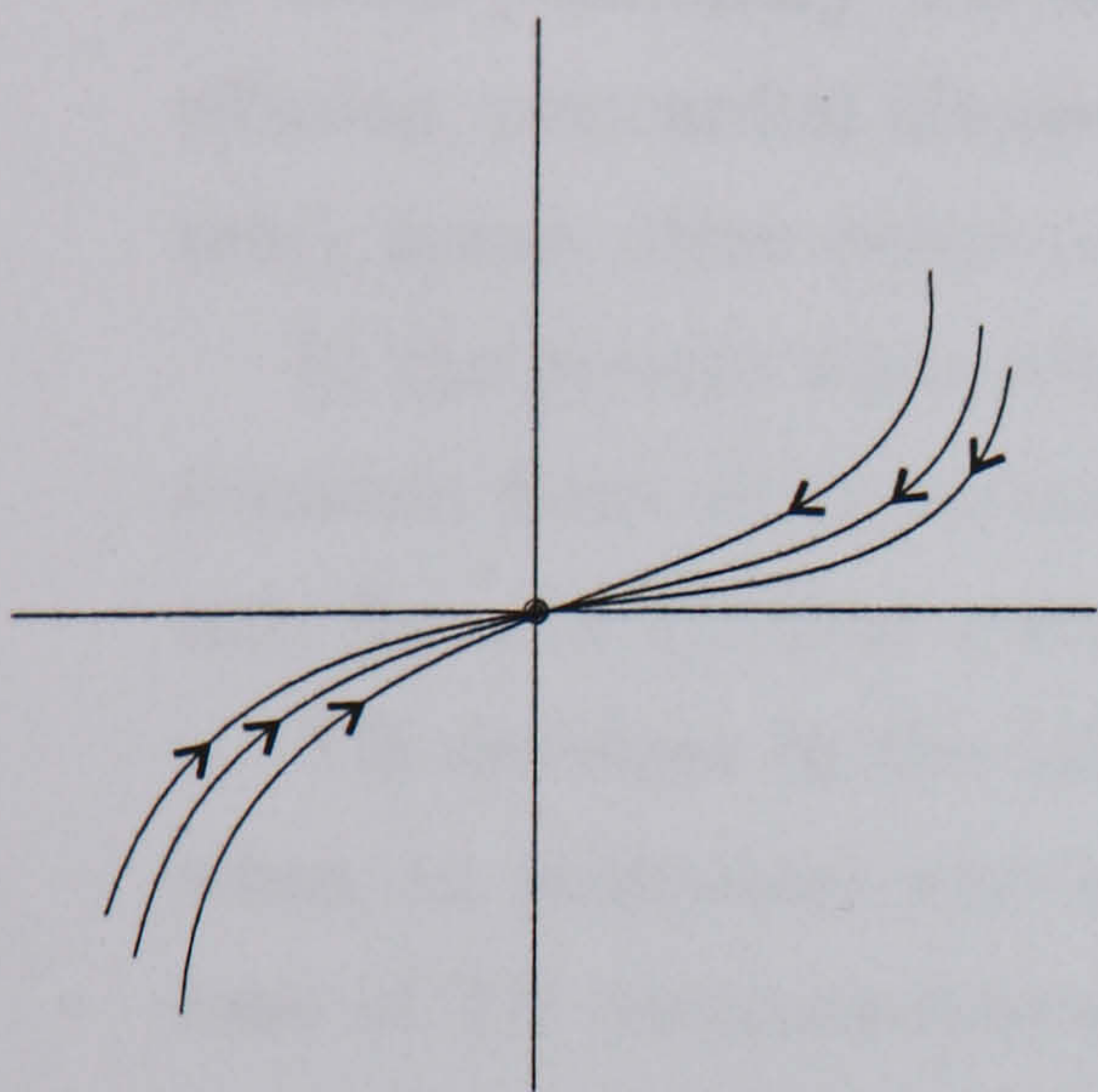

Shearing motion  
(positive attractor)

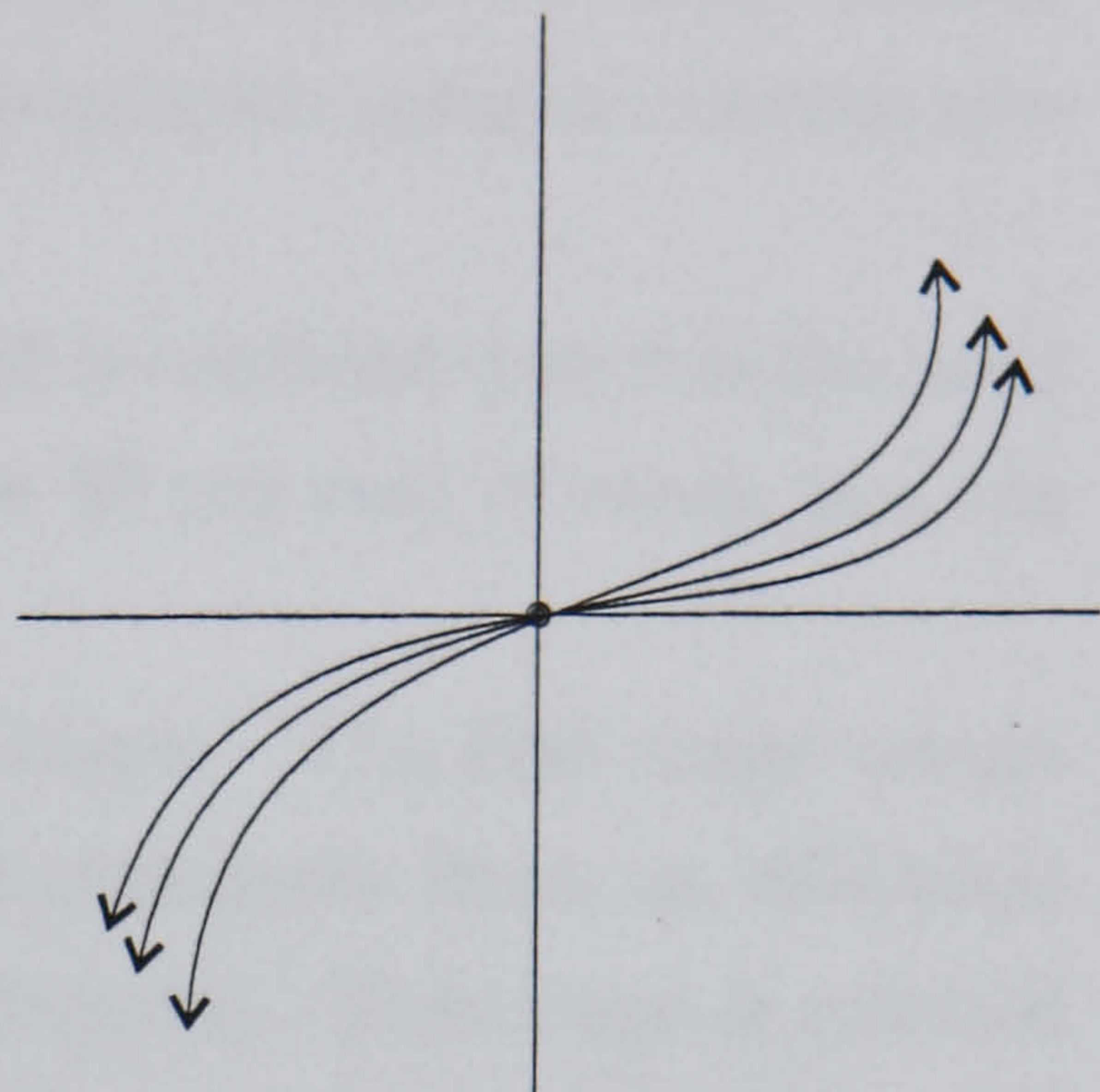

Shearing motion  
(negative attractor)

Fig. 3 c) Phase-plane diagrams for two dimensional systems



Two main forms of TB exist: pulmonary TB and extra-pulmonary TB. Pulmonary TB, the commonest form of TB, leads to extensive lung destruction with cavitation and upper lobe involvement. The characteristic features of extra-pulmonary TB are: lymphadenopathy (usually cervical), pleural effusion, pericardial disease, miliary disease, meningitis (central nervous system), spine, other bones and joints.

In the present work only the pulmonary TB is considered as it is the most common form of the disease, occurring in over 80 per cent of cases, and the only form of TB that is infectious.

TB develops in the human body in two stages. The first stage occurs when an individual who is exposed to micro-organisms from an infectious case of TB becomes infected (tuberculous infection). This stage is referred as the *passive* TB infectious case. Subsequently, at a second stage, some of the individuals,<sup>61</sup> who have become infected, develop the disease (TB) from this infection. This stage is referred as the *active* TB infectious case.

Transmission occurs by airborne spread of infectious droplets. The source of infectious is a person with TB of the lung who is coughing. TB of the lung is pulmonary TB. Coughing produces tiny infectious droplets. One cough can produce 5,000 droplet nuclei.<sup>62</sup> Transmission generally occurs indoors, where droplet nuclei can stay in the air for a long time. Ventilation removes droplet nuclei. Direct sunlight quickly kills tubercle bacilli, but they can survive in the dark for several hours. Two factors determine an individual's risk of exposure: the concentration of droplet nuclei in contaminated air and the length of time the disease is kept at a passive status.

An individual's risk of infection depends on the extent of exposure to droplet nuclei and his susceptibility to infection. The risk of transmission of infection from a person with sputum smear-negative pulmonary TB is low and with extra-pulmonary TB is even lower. The risk of infection of a susceptible individual is high with close, prolonged, indoor exposure to a

---

<sup>61</sup>Only 10 per cent of passively TB infected individuals develop active disease. WHO, 1998b.

<sup>62</sup>WHO, 1998b.



person with sputum smear-positive pulmonary TB. The degree of crowding and of intimacy of exposure are therefore important factors.

Overall, one-third of the world's population is infected with the tubercle bacillus. Those with the disease infect approximately 100 million people each year. It has been estimated that an untreated infected/infectious person will infect on average between 10 and 15 people every year. WHO projections, foresee that between 2000 and 2020 nearly 1 billion people will be newly infected if control is not further undertaken.<sup>63</sup>

Individuals are most likely to develop disease in the period immediately following infection but they continue to be exposed to risk of TB throughout the remainder of their lives. The development of TB following infection with TB micro-organisms is usually prevented by the immunosystem. When the protection provided by the immunosystem is reduced, the TB micro-organisms that are dormant begin to multiply, causing TB disease. As reported by WHO (2000a), around eight million people become TB infected each year (more than one and half million TB cases per year in sub-Saharan Africa, nearly three million TB cases per year in south-east Asia and over a quarter of a million TB cases per year occur in Eastern Europe). Once infected, the likelihood of developing active TB is 10 per cent in a lifetime.<sup>64</sup> Worldwide, the most important predisposing cause of immunosuppression leading to TB is HIV infection. As stated by Weatherall et al. (1996) patients with congenital or acquired immunosuppression are particularly prone to TB. HIV/AIDS infection considerably enhances the reactivation rate of TB in the infected person (about 10 per cent of both HIV and TB infected people<sup>65</sup> develop active TB each year) and makes TB the leading cause of death among people who are HIV positive.<sup>66</sup> Other factors which have favoured

---

<sup>63</sup>WHO, 2000c.

<sup>64</sup>International Union Against Tuberculosis and Lung Disease, 1996.

<sup>65</sup>In late 1994 about 12 million persons were estimated to be infected with HIV, 5.6 million of them were co-infected with TB. WHO, 1998b, 2000a.

<sup>66</sup>As reported by WHO (2000a, b, c), a HIV-positive individual who is also passively TB infected is 30 times more likely to become TB infected than a TB infected individual who is HIV negative. Chaulet, 1987; De Cock and Chaisson, 1999; Menzies et al., 1993;

the spread of communicable diseases<sup>67</sup> are poverty, malnutrition, overcrowded housing and poor hygienic conditions which often follow rapidly increasing urbanization.<sup>68</sup> Geographical extensions of urban areas are often associated with deteriorating and crowded living/working conditions, such as lack of transport, water, drainage and health care delivery.

Furthermore, the emergence of a particularly dangerous form of drug-resistant TB, the multidrug-resistant TB (MDR-TB), where TB bacilli are resistant to the most powerful anti-TB drugs, has been reported as a new epidemic.<sup>69</sup> Drug-resistant TB is caused by inconsistent or partial treatment that leaves the patients still infectious with bacilli that may develop resistance to anti-TB drugs.<sup>70</sup> People they infect will have the same drug-resistant strain that, although treatable, requires expensive and more toxic

---

Reichman, 1991; Rubel and Garro, 1992; WHO, 1998b, 2000a.

<sup>67</sup>Barnhoorn and Adriaanse, 1992; Chan-Yeung et al., 1971; Mata, 1985; Nightingale et al., 1990; Wallace and Wallace, 1997.

<sup>68</sup>As reported by UN, nearly two-thirds of the world's current urban population live in the developing world. UN, 1996a, 1996b, 1997, 1998; UNU/WIDER, 1998a, 1998b.

<sup>69</sup>An individual can be resistant to one or more of the antiTB drugs. The terms *monodrug* and *multidrug-resistant TB* refers to TB that is resistant to one or more antiTB drugs, respectively. Primary or initial drug resistance refers to a drug-resistant TB patient who has not been previously treated with antiTB drugs and who has become infected as a result of contact with a person with drug-resistant TB. Secondary or acquired drug resistance refers to drug-resistant TB patients who were drug-susceptible TB and developed drug-resistant TB in the course of drug therapy. The main cause of secondary drug-resistance is a patient's irregular adherence to a prescribed regimen of antiTB drugs. WHO, 2000a.

<sup>70</sup>MDR-TB is very difficult and costly to treat (Centers for Disease Control, 1992). If a patient has MDR-TB, the duration of the treatment increases from six months to between eighteen to twenty-four months and cure rates decrease from nearly 100 per cent to less than 60 per cent (Gittler, 1994; National MDR-TB Task Force, 1992). Furthermore, total MDR-TB treatment costs are about ten times higher than the costs of drug-susceptible TB treatment and the costs of drugs for MDR-TB are approximately twenty-one times the costs of drugs for drug-susceptible TB (Institute of Medicine, 1992). Moreover, individuals with drug-resistant TB may be infectious to others for longer periods of time (Frieden et al., 1995; Villarino et al. 1992).



chemotherapy treatment.<sup>71</sup> It differs from previously described outbreaks in that it has spread rapidly, involved larger numbers of patients and has occurred in institutions (e.g. prisons).<sup>72</sup>

Migration also favours the spread of TB. Two million people cross international borders each day and more than one million travel from developing to industrialized countries each week.<sup>73</sup> In most developed countries TB is no longer endemic and at least one-half (in the US, 40 per cent) of TB cases are among foreign-born people. The increasing number of refugees, displaced people (e.g. homeless or prisoners) contributes to the resurgence of TB also in developed countries. As many as 50 per cent of the world refugees and nearly 50 per cent and 30 per cent of San Francisco and London's homeless, respectively, were reported to be TB infected.<sup>74</sup>

*Bacille Calmette-Guerin* (BCG) is a live attenuated vaccine derived originally from *M. Bovis*. The benefit of BCG is in protecting young children against disseminated and severe TB<sup>75</sup> (TB meningitis and miliary TB). BCG has little or no effect in reducing the number of adult cases of TB. Therefore, the vaccination is not considered in this model.<sup>76</sup>

### 2.2.2 Definition and Basic Concepts in Epidemiology

Before beginning a somewhat extended discussion of general epidemiological models of infectious disease, it is necessary to establish the definition of an epidemic/endemic status. Currently, there is no commonly accepted defini-

---

<sup>71</sup>WHO, 2000a.

<sup>72</sup>Weatherall et al., 1996; WHO, 2000a.

<sup>73</sup>WHO, 2000a.

<sup>74</sup>Nardell et al., 1986; Wallace and Wallace, 1997; WHO, 2000a.

<sup>75</sup>Vaccination in childhood has little impact on controlling the spread of TB microorganisms in the community because the type of TB prevented by it is usually not the infectious form (smear positive pulmonary TB) as this form is uncommon in childhood. International Union Against Tuberculosis and Lung Disease, 1996.

<sup>76</sup>References of models with vaccination are provided by Anderson, 1982; Anderson and May, 1982, 1984; Hethcote, 1983; Hethcote and Van Ark, 1987.



tion of epidemic/endemic status. Hethcote<sup>77</sup> generally defines an epidemic as "an occurrence of a disease in excess of normal expectancy, while a disease is called endemic if it is habitually present (more than 10 or 20 years)". Anderson and May (1982) define an epidemic as a sudden, rapid spread or increase in the prevalence and intensity of a parasite or disease while endemic refers to a disease or parasitic infections whose abundances do not exhibit wide fluctuations through time in a defined spatial location.

A large part of the literature refers to one of the basic concepts in epidemiology: the existence of thresholds as critical values for quantities that must be exceeded in order for an epidemic to occur. Some of the most important contributions<sup>78</sup> which are applications of more classical formulations of Hamer (1906), Ross (1908, 1911), Kermack and McKendrick (1927), identify the threshold quantity as the average number of susceptible infected by an infective during the infectious period (this quantity is better known as the Basic Reproductive Rate - BRR). With constant infection rates, when the BRR exceeds unity, an epidemic will occur and eventually everyone will be infected. For  $BRR < 1$  the infection dies out and for  $BRR = 1$  the infectious disease will stay at an endemic status with a constant proportion of not infected individuals. A weakness of this approach is the assumption that the threshold is constant independently of the structure of the population. In the basic Lotka-Volterra model, characterised by a stationary point which is a centre, during the cycle the structure of the population is changing leading to a variable threshold level so that explosive epidemics do not occur.

In what follows, an epidemic is defined as the widespread occurrence of a disease above a certain critical level, characterized by a (increasing) rate of the spread of infectious disease.

---

<sup>77</sup>Hethcote (1976, 1989) provides another general definition of epidemic as an unusually large, short term outbreak of a disease.

<sup>78</sup>Blower et al., 1995; Hethcote, 1976, 1980; May and Anderson, 1990; May et al., 1988.

### 2.2.3 The Basic Epidemiological Model: the Predator-Prey Lotka-Volterra Model

The study of epidemics has a long history with a vast variety of models and explanations for the spread and cause of epidemic outbreaks. Some models for the population dynamics of infectious diseases caused by viruses and bacteria are based on the view of disease as a predatory organism searching for human prey to consume with clear reference to the simplest model for a predator-prey system: the classical predator-prey Lotka-Volterra<sup>79</sup> model.

The set of equations for a deterministic one-prey-one-predator system with continuous growth is

$$\begin{cases} \dot{x} = x(t) [a - by(t)] \\ \dot{y} = y(t) [cx(t) - d] \end{cases} \quad (6)$$

where:  $x(t)$  and  $y(t)$  represent prey and predator population respectively, at time  $t$ ;  $a$  the prey population growth rate and  $d$  the predator death rate, for constant  $a, d > 0$ ;  $b$  and  $c$  the interaction between the species, for constant  $c, d > 0$ .

It follows that an exponential growth rate,  $a$ , (in absence of predation) for the prey population is assumed; the prey population death rate is represented by the effect of predation ( $b x(t) y(t)$ ). In the absence of any prey for sustenance the predator's death rate results in exponential decay ( $-d y(t)$ ). Predators depend on the presence of their prey to survive.

The effect of the predation is to reduce the prey's per capita growth rate by a term proportional to the prey and predator population, the so called predator's *functional response*, represented by the term  $-b x(t) y(t)$ . The prey's contribution to the predator's growth rate is proportional to the avail-

---

<sup>79</sup>Volterra (1926) first proposed a simple model for the predation of one species by another to explain the oscillatory levels of certain fish catches in the Adriatic sea. The model is known as the Lotka-Volterra model since the same equations were also derived by Lotka (1923) from a hypothetical chemical reaction that he said could exhibit periodic behaviour in the chemical concentrations (dependent variable).



able prey and to the size of the predator population. This term,  $c x(t) y(t)$ , represents the rate of predation or *numerical response*. The form of the encounter rate,  $x(t) y(t)$ , is derived from the *mass action principle*, which states that the rate of molecular collisions of two chemical species in a dilute gas or solution is proportional to the product of the two concentrations. Following Edelstein-Keshet (1988), the terms  $x(t) y(t)$  can be also interpreted as the conversion of energy from one source to another:  $b x(t) y(t)$  is taken from the prey and  $d x(t) y(t)$  accrues to the predators. Consequently, the  $\frac{b}{c}$  ratio is analogous to the *efficiency of predation*, the efficiency of converting a unit of prey into a unit of predator mass.

As a first step in analysing the dynamic of the predator-prey population given by (6) and (??) the possible stationary states are calculated. Two equilibrium points exist:

$$(x_1^*; y_1^*) = (0; 0) \quad (7)$$

and

$$(x_2^*; y_2^*) = \left( \frac{d}{c}; \frac{a}{b} \right) \quad (8)$$

The stationary state levels of prey/predator are independent of its own growth rate or mortality and they are function of parameters related to the predator/prey.

A linearization about the two steady states determines the local stability properties. Let  $x$  and  $y$  be small perturbation about  $(0; 0)$  and  $(\frac{d}{c}; \frac{a}{b})$ . If we keep only linear terms, (6) and (??), gives the following Jacobians

$$\begin{bmatrix} a & 0 \\ 0 & -d \end{bmatrix} \quad (9)$$

and

$$\begin{bmatrix} 0 & -\frac{bd}{c} \\ \frac{ca}{b} & 0 \end{bmatrix} \quad (10)$$



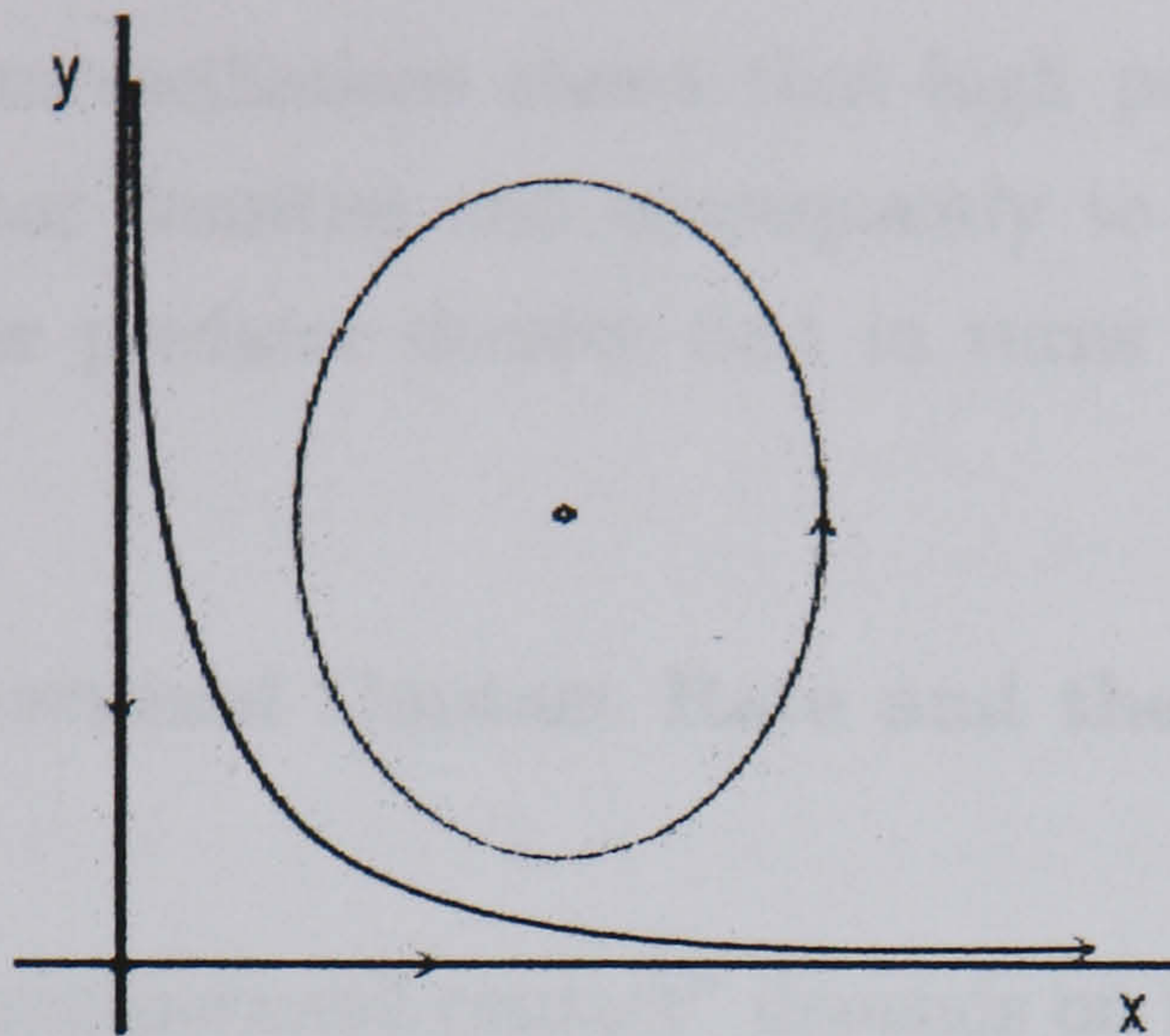

Figure 4: Phase-plane diagram, predator-prey Lotka-Volterra model

for each of the two steady states,<sup>80</sup> respectively. Here,  $x$  and  $y$  are now measured as deviations from a particular stationary point and derivatives in the Jacobian are evaluated at that stationary point.

In this ecological context the *stability matrices* in (9) and (10) are called the *community matrices* and their eigenvalues  $\eta_1$  and  $\eta_2$  for each case determine the stability of the steady states.

The eigenvalues  $\eta_1$  and  $\eta_2$  are given for (9) and for (10) by

$$\eta_1 = a; \quad \eta_2 = -d \quad (11)$$

$$\eta_{1,2} = \pm \sqrt{dai} \quad (12)$$

Therefore, since in (11)  $\eta_1 > 0$  and  $\eta_2 < 0$  and in (12)  $\eta_{1,2} = \pm i\sqrt{da}$  (with real parts equal to zero), the steady state  $(x_1^*; y_1^*) = (0; 0)$  is a *saddle point* and  $(x_2^*; y_2^*) = (\frac{d}{c}; \frac{a}{b})$  is a *centre*. A complete phase-plane diagram of the predator-prey type model is provided in Fig. 4.

<sup>80</sup>As  $\frac{\delta \dot{x}}{\delta x} = a - by$ ,  $\frac{\delta \dot{x}}{\delta y} = -by$ ,  $\frac{\delta \dot{y}}{\delta x} = cy$  and  $\frac{\delta \dot{y}}{\delta y} = cy - d$  we have that at  $(x_1^* = 0, y_1^* = 0)$  and  $(x_2^* = \frac{d}{c}, y_2^* = \frac{a}{b})$  the Jacobian is as in (9) and in (10), respectively.



The propensity to oscillations shows that high prey densities tend to produce high predator densities and consequently to reduce prey density. This makes for lower predator density that in turns leads to higher prey densities.

#### 2.2.4 The Interpersonal Contact Rate and the TB Transmission Coefficient

The nature of the "interpersonal contact" depends on the way parasites are transmitted among people.

When *direct transmission* occurs the parasites (i.e. viruses and bacteria) may pass by direct contact between individuals or in vapour droplets.

When *indirect transmission* occurs the parasite completes its life cycle by passing through one or more species of intermediate host.

In case of *sexually transmitted diseases*, the contacts take place at two levels (partner and sexual contacts within partnership).

As TB is a bacterial disease caused by Mycobacterium TB that occurs by direct airborne spread of infectious droplets from a source of infection (a person with pulmonary TB - usually smear positive), in what follows only direct transmission of infectious diseases is considered.

In mathematical-epidemiological models the force of infection, defined as the probability per unit time that a given susceptible individual becomes infected<sup>81</sup> is a crucial element. The force of infection generally is expressed considering the contacts between individuals occurring by random encounters and being proportional to the product of three factors. The first factor is the contact rate defined as the average number of relevant contacts with other individuals per unit time. The second factor is the probability that, if such a contact occurs, it is with an infectious individual. The third is the probability that such a contact with an infectious individual results in the actual transmission of the infection. The first two factors represent the meeting process while the third represents the infection process (Fig. 5).

---

<sup>81</sup>De Jong et al., 1995.



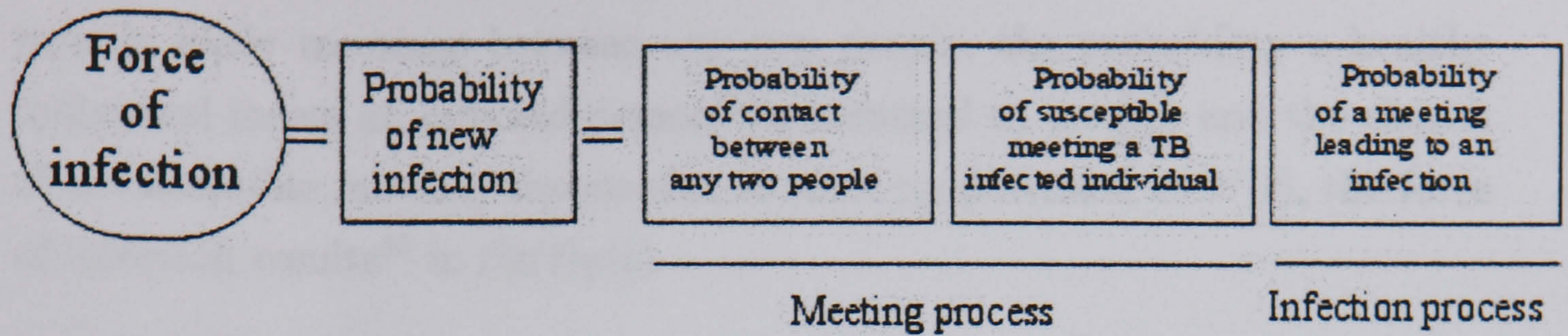

Figure 5: TB transmission mechanism

The chance of infection from an encounter between an infected and a susceptible person,  $\beta$ , is usually assumed to be a constant. For different diseases  $\beta$  is defined by individual characteristics (i.e. the age of the susceptible individual) or characteristic of the meeting (i.e. indoor/outdoor coughing). The main exception to this is a form of density dependence where individual behaviour may change to reduce the chance of infection<sup>82</sup> (i.e. for higher level of TB prevalence, an individual may wear protective clothing or altering the nature of the meeting). In common with the literature we abstract from this and assume homogeneity within population groups in terms of health status and characteristic of the meeting.

The meeting process is usually represented by a model of social interaction and, within that, the susceptible-susceptible or susceptible-infected encounter probability is considered. A standard approach in mathematical epidemiology<sup>83</sup> is to consider the probability of a susceptible individual to meet an infected individual, given a meeting, to be given by  $\frac{y(t)}{N(t)}$ , the proportion of infected individuals in a population with constant size  $N(t) = x(t) + y(t)$ . As here  $\beta$  represents the probability of infection from an encounter between a susceptible and an infected individual, the force of infection is given by  $\frac{\beta x(t)y(t)}{N(t)}$ . However, a density effect has been included in the meeting process analysis to represent situations where in a given region to higher population density corresponds a higher number of meeting between people.<sup>84</sup> As for

<sup>82</sup>Philipson, 1995.

<sup>83</sup>Hamer, 1906; Kermack and McKendrick, 1927; De Palma and Lefevre, 1988;

<sup>84</sup>The density dependent effect can also be included in the analysis through the infection



equally likely meetings between any two people, the probability a healthy individual meets an infected person<sup>85</sup> is assumed to be  $\frac{y(t)}{N(t)}$  and the chance of a susceptible meeting anyone else at all is proportional to  $N(t)$ , the force of infection results<sup>86</sup> in  $\beta x(t)y(t)$ .

### 2.2.5 The Incubation Period

A good deal of the recent literature<sup>87</sup> on TB infectious disease deals with the latent status. Two main ways of representing the latent status are identified. The first one considers the latent as a class of people who are not infectious and have either been (exposed) infected and did not develop Primary TB infection or have just recovered from their first Primary TB infection. Alternatively, a time-dependent interpretation is given. The latent status is defined as the period between exposure (the point of infection) and the onset of infectiousness.

Before assessing the influence of the latent on the results of the dynamic analysis, it is necessary to explore the pathological relation between the latent and the infected class and to clarify the role played by time-delays in such a relationship.

**Primary and Post-primary TB Infection.** The first stage in the natural history of TB, given by the implantation of tubercle bacilli into tissue, after about 4-6 weeks is followed by immune responses (delayed hypersensitivity and cellular immunity) leading to resolution of disease (Weatherall, 1996; WHO, 1998b). Immune responses in TB may be: protective or tissue

---

process ( $\beta = \beta(x + y)$ ).

<sup>85</sup>An alternative approach is to consider the transmission coefficient,  $\beta$ , to have dimension  $\frac{1}{N(t)}$ .

<sup>86</sup>This approach has been taken by May and Anderson (1989) in exploring the dynamics of HIV/AIDS.

<sup>87</sup>Blower et al., 1995; Castillo-Chavez, 1978; Hethcote et al., 1981b; Wallace and Wallace, 1997; WHO, 1998b.



destroying.<sup>88</sup> When the immune responses in TB are *protective*, they stop multiplication of bacilli and they lead to the resolution of the disease and, consequently, to natural TB immunization (5 per cent of the population) If the immune responses in TB are *tissue destroying* they lead to pathological characteristics of active disease. Once TB infected, an individual can develop TB disease at any time. The vast majority (90-95 per cent) of people do not develop TB disease. In these healthy, asymptomatic, but infected individuals, the only evidence of infection may be a positive tuberculin skin test.

When a latent gets active TB is poorly understood but probably includes various non-specific immune defence mechanisms, the size of the infecting dose, priming of the specific immune defences by contact with environmental mycobacteria and the patient's general state of health and nutrition.

There are two main different ways to develop a pathological active TB: Primary TB and Post-primary TB infection.

*Primary TB infection* begins with multiplication of tubercle bacilli at the site of implantation of the initial infection with Mycobacterium TB.

There are different interpretations about when Primary TB infection develops. Holm (1969) and subsequent writers such as Vynnycky and Fine (1997) consider Primary TB infection as a disease occurring less than five years after first initial infection. Weatherall (1996) does not provide any time limit definition of Primary TB infection. Blower et al. (1995) define Primary TB infection as "fast TB" or "direct progression" and, referring to Comstock (1982a, b), interpret the expression "few months" as "within one year".

*Post-primary TB infection* results from endogenous reactivation or exogenous reinfection. As defined in WHO (1998b) and Weatherall (1996), *endogenous reactivation* implies that dormant bacilli surviving in tissues for

---

<sup>88</sup>There is no clear evidence about whether protective and immunopathological responses are manifestations of the same mechanism differing only in degree or whether they represent different mechanisms. There is evidence that protective immune responses are induced by antigens that are common to all mycobacterial species while antigens restricted to tubercle bacilli are responsible for immunopathological reactions. Weatherall, 1996.



months or years after the initial Mycobacterium TB infection start to multiply. *Exogenous reinfection* (also called *superinfection*) is given by repeat infection with Mycobacterium TB in a person who has already previously infected. The course of post-primary TB is very variable. Some patients progress from being completely well to having extensive disease within a few weeks or even days while others have chronic symptoms for several years before seeking medical attention.

Many factors influence this lifetime risk like the individual risks of developing, respectively, primary and post-primary TB infection.

People tend to have different developing rates of infection depending on the body structure and living environment. A person whose body is immunodepressed and lives in a poor or stressed environment will develop TB at a higher rate than an individual who has good physical and living conditions.

Many observational studies provide evidence that the individual risk of developing primary, endogenous and exogenous reinfection mainly are function of:

- the time since initial infection (length of inactive period); it is greatest shortly after completing therapy and decreases with time.<sup>89</sup>

- the age distribution of individuals at risk: it is greater among adults than children.<sup>90</sup>

- the annual risk of infection; it appears to be decreasing as the prevalence of TB infection cases decreases with time.<sup>91</sup>

- the degree of tuberculin sensitivity at the start; it is estimated to be lower for individuals with a small amount of tuberculin sensitivity at the start of follow up than for who "converted" to tuberculin positivity.<sup>92</sup>

- the HIV/AIDS infection as reported in Section 2.2.1.

Overall to consider the basic natural history of TB as related to the incubation period is a complex matter due to three different mechanisms

---

<sup>89</sup>Castillo-Chavez, 1978; Comstock, 1982a, b; Grzybowski, 1965; Nakielna et al., 1975.

<sup>90</sup>Comstock, 1982a, b; Vynnyvky and Fine, 1997.

<sup>91</sup>Comstock, 1982a, b.

<sup>92</sup>Comstock, 1982a, b; Vynnyvky and Fine, 1997.



underlying the disease that have not been yet completely understood.

First, as stated by Vynnycky and Fine (1997), the effect of reinfection on the disease risk, while an individual is still at a high risk of developing disease from a preceding infection or reinfection event is unclear. It is also disputable whether the primary disease episode within the first year of initial infection among individuals who have been reinfected can be related to bacilli from the first or the second infections or both infection and reinfection events.

Second, there is no general consensus about the relationship between the infection rate for susceptible individuals and the reinfection rate for the latent individuals. As in Vynnycky and Fine (1997), it can be asserted that it is likely that reinfection occurs at any time although it may be less likely than initial infection once an individual has developed an immune response to *Mycobacterium TB* antigens. The lack of empirical estimates of the magnitude of the difference leads the assumption the infection and reinfection rates being identical.

Finally, there is no common agreement about the relative frequency of disease through endogenous reactivation and exogenous reinfection. Many of these studies have assessed the role of exogenous reinfection as opposed to endogenous reactivation as the cause of Post-primary TB infection. One of the earliest evidence that exogenous reinfection plays an important role is an anatomical study<sup>93</sup> which was conducted during the period 1930-50 on individual who died from diseases other than TB. Canetti (1972) infers the relative importance of endogenous reactivation compared with exogenous reinfection by observing that TB bacilli inoculated into guinea pigs may not survive indefinitely in primary complexes. Rich's (1951) main result proves that exogenous reinfection plays an important part in the transmission of TB infection. Romeyn (1970) asserts again the central role of exogenous TB reinfection by linking it with situations which involve high risk of exposure. Another empirical study conducted by Ormerod and Skinner (1980), documents exogenous reinfection by changes in drug-susceptibility patterns.

---

<sup>93</sup>Canetti, 1972.



The study is conducted on a sample of two sons with a disease resistance pattern identical to that of their mother who died six months before of drug-resistance TB. In 1986 a study,<sup>94</sup> conducted on a shelter for the homeless in Boston finds that about one third of the total outbreak of TB cases is attributable to exogenous reinfection.

As stated so far the importance of exogenous reinfection is always related to situations involving a high prevalence of TB infection.<sup>95</sup> Therefore, exogenous reinfection has to have a central role especially in developing countries where TB risk exposure is very high and where people are malnourished and live in overcrowded and poor healthy conditions.<sup>96</sup>

**Review of related work: the latent class models** The main features of the latent class models are that the population is divided into three or four disjoint classes (including the latent) that change with time.<sup>97</sup> The dynamics of these classes is described by a system of three-four differential equations.

Blower et al. work (1995) includes the analysis of the role of the latent class in the TB transmission dynamics. The model describes the dynamics of three groups: the susceptible individuals ( $X$ ), the latently infected individuals ( $L$ ) and the active infectious cases ( $T$ ). Specifically,

$$\begin{cases} \dot{X}(t) = \Pi - \lambda(t)X(t) - \mu X(t) \\ \dot{L}(t) = (1-p)\lambda(t)X(t) - vL(t) - \mu L(t) \\ \dot{T}(t) = vL(t) + p\lambda(t)X(t) - (\mu + \mu_T)T(t) \end{cases} \quad (13)$$

where  $\lambda(t) = \beta T(t)$  is the per-susceptible risk of becoming infected with TB. The mass action principle is applied in being the product of the number

---

<sup>94</sup>Barry et al., 1986.

<sup>95</sup>Although after the introduction of chemoprophylaxis the declining prevalence of TB infection makes exogenous reinfection less and less likely in developed countries, it has been analysed in many case reports: Bates et al., 1976; Grzybowski et al., 1965; Ormerod and Skinner, 1980; Raleigh and Wichelhausen, 1973; Raleigh et al., 1975.

<sup>96</sup>Ten Dam and Pio, 1982.

<sup>97</sup>References about latent class models for general infectious diseases are provided by Anderson and May, 1991; Bailey, 1975; Hethcote, 1989; Hethcote et al., 1981



of infectious cases which are present at time  $t$  ( $T(t)$ ) and the transmission coefficient,  $\beta$ , of the pathogen. Here,  $\beta$  reflects the probability that an infectious case successfully transmit the infection to a susceptible. The per capita average non-TB mortality rate is  $\mu$  and  $\nu$  is the rate at which the latent individuals develop active TB. Here  $(1 - p)$  is the proportion of the newly infected who enters the latent class given that  $p$  is the proportion of newly infected who develops TB directly.

Although the model presents a quite high level of complexity, the definition of latent class provided here does not entirely reflect the complexity of the natural history of TB in that the exogenous reinfection mechanism of developing TB disease is not incorporated in their model. Susceptible people are assumed to develop active TB "soon" after the initial infection (so called fast TB or direct progression to the infected class) or through endogenous reactivation "slowly at a average rate" over lifetime.

WHO-GTP (1997) age-structured model follows a similar approach to assess the impact of a treatment program (Direct Observed Treatment Strategy) for the global TB epidemic on the dynamic of six different classes (susceptible, latent, actively infected - infectious and non-infectious - and temporary cured people - infectious and non-infectious cases) and provides the expected changes in incidence from the present until the year 2020. This model suffers from the same limitations as Blower et al. (1995). Specifically, the models assume the susceptibles grow in arithmetic rather than geometric progression so that there is a decreasing net birth rate as the population of susceptible rises.

**Review of related work: the time-dependent latent models** Outside of latent class models, attempts are made to interpret the latent status as time-dependent. Infected people can develop TB disease subject to various physical or emotional stresses which may activate progression of infection to disease at any time over the lifetime of an individual. This justifies the incorporation of one or more time delays in the infection process to take into



consideration the effects of delays in the physical response to the disease. It is possible to incorporate such delay effect by considering integro-differential equation models of the form

$$L(t) = L(0) + \beta \int_0^t S(u) I(u) P(t - u) du \quad (14)$$

where  $\beta$  is the contact rate,  $S(t)$  and  $I(t)$  are the number of susceptible and infected people respectively and  $P(t)$  is the probability that an individual remains in the latent class at least  $t$  units of time before becoming infectious. The factor  $\beta \int_0^t S(u) I(u) P(t - u)$  represents the transfer of individuals out of the susceptible class ( $S(t)$ ) who enter the latent class ( $L(t)$ ) and join the fraction of latent ( $L(0)$ ) who have been (passively) infected before time 0 and remain so over the interval  $[0, t]$ .

The vast majority of the works with a time-dependent analysis include the time-delay structure in the infected or the recovered classes. The time-dependent interpretation is considered to examine the pattern of the disease by quantifying the amplitude of the oscillations.<sup>98</sup>

An observational analysis,<sup>99</sup> which attempted to analyse the overall lifetime individual risk of developing disease as a time-dependent process has been carried out by US Public Health Service Chemoprophylaxis during the 50's. It provides some data on the risks of developing disease given recent and distant infection. The main outcome suggests that a vast majority of people (41 per cent) developed disease during the first year of the trial corresponding to an annual risk of 1.22 per cent. This dropped to 0.31 per cent per year for the following two years and was about 0.16 per cent per year during the sixth and seventh years. Sutherland et al. (1982) in a study on the disease incidence in a population of Dutch males for the period 1951-70 estimate that the annual risks of developing disease are 5.01 per cent per year during the five years after the first infection, 1.91 per cent per year during the first five years after reinfection and 0.0253 per cent per year for a distant

---

<sup>98</sup>Anderson and May, 1991.

<sup>99</sup>Ferebee, 1970.



Primary infection with no reinfection. This corresponds to a risk of 23 per cent and 9 per cent of developing Primary and exogenous disease during the first five years after the first infection and reinfection, respectively.

Although many studies on transmission of infectious diseases<sup>100</sup> interpret the latent status according to a time-delay view, no study attempts to provide a time-delay analysis of the latent status for the TB transmission dynamic.

The content of the general overview shows that many efforts have still to be made in order to examine the influence of the distribution of the latent class over time on the overall dynamic of the population with vital dynamics. There is always a balance between models which are descriptively realistic and analytically tractable. With the analysis of the latents, present models emphasize the analytical tractability.

## 2.2.6 The Recovered Class

There is a prolific part of the epidemiological literature on the spread of infectious diseases which confer temporary or permanent immunity.<sup>101</sup> Individuals recover and are removed from the infective class but in case of temporary immunity they can eventually become susceptible again.

TB is a curable disease. After completing an adequate course of therapy with appropriate drugs, very few patients will develop the disease again. Moreover, as an adequate treatment is rarely provided, *recurrent or relapsed cases*<sup>102</sup> of TB contribute about one-third of all active cases registered annually.<sup>103</sup>

The analytical structure generally adopted for cases where recovery leads

---

<sup>100</sup>Detailed surveys of the different contributions on the time delay analysis for general infectious diseases can be found in Hethcote, 1980; Hethcote et al., 1981a; Hethcote, 1989.

<sup>101</sup>Recent reviews on studies that included the recovered class, as Hethcote (1980) can provide detailed references.

<sup>102</sup>Recurrent case is a person who verified TB in the past, was discharged from or lost to supervision for more than 12 months and who has verified disease again (Kopanoff et al., 1988) or has once again developed sputum smear-positive TB (WHO, 2000a).

<sup>103</sup>Castillo-Chevez, 1978; Grzybowski et al., 1965; Kopanoff et al., 1988; Nakielma et al., 1975.



to permanent immunity is similar to that one used in the Blower et al.'s (1995) epidemic model on the dynamic transmission of TB. The detailed model<sup>104</sup> is given by

$$\begin{cases} \dot{X}(t) = \Pi - \lambda(t)X(t) - \mu X(t) \\ \dot{L}(t) = (1-p)\lambda(t)X(t) - vL(t) - \mu L(t) \\ \dot{T}(t) = vL(t) + p\lambda(t)X(t) - (\mu + \mu_T)T(t) - \theta T(t) \\ \dot{R}(t) = \theta T(t) - \omega R(t) \end{cases} \quad (15)$$

where  $X(t)$ ,  $L(t)$ ,  $T(t)$  and  $R(t)$  represent the susceptible, latent, active infectious TB and recovered individuals. Here  $\Pi$  is the constant rate of recruitment to the susceptible population,  $\lambda(t)$  the per-susceptible risk of becoming infected with M. TB,  $\mu$  the per capita average non-TB mortality rate,  $\mu_T$  the per capita average TB mortality rate,  $v$  the rate at which the latent individuals develop active TB,  $\theta$  the rate at which recovered individuals leave the infected class and  $\omega$  the recovered death rate. The proportion of newly infected who develop TB directly is  $p$  and, therefore,  $(1-p)$  the proportion of the newly infected who enters the latent class. Recall that according to the mass action principle,  $\lambda(t) = \beta T(t)$  is the product of the number of infectious cases that are present at time  $t$  ( $T(t)$ ) and the transmission coefficient  $\beta$  of the pathogen. Here,  $\beta$  reflects the probability that an infectious case successfully transmit the infection to a susceptible. A limit to this approach is that for  $\lambda(t)X(t)$  to represent the number of new infected people we need to assume that  $\beta$ , for instance, has dimension  $\frac{1}{N(t)}$  with  $N(t) = X(t) + T(t)$ .

In the epidemiological literature where recovery does not lead to immunity a very common way of modelling the infection disease dynamics is the Lotka-Volterra type system

---

<sup>104</sup>The Blower et al. (1995) model provided here is a simplification of the original one in that the infectious class is divided in infectious and non infectious individual.



$$\begin{cases} \dot{X}(t) = \alpha X(t) + \dot{R}(t) - \beta(X(t), L(t), Y(t))X(t)Y(t) \\ \dot{L}(t) = \beta(X(t), L(t), Y(t))X(t)Y(t) - (\lambda_1 + \lambda_2 + \lambda_3)L(t) \\ \dot{Y}(t) = \lambda_2 L(t) - \omega Y(t) - \rho Y(t) \\ \dot{R}(t) = \rho Y(t) + \lambda_3 L(t) \end{cases} \quad (16)$$

with

$$N(t) = X(t) + Y(t) + L(t) + R(t) \quad (17)$$

where  $X(t)$  is the stock of susceptibles;  $L(t)$  is the stock of latently infected;  $Y(t)$  is the stock of actively infected;  $R(t)$  is the stock of recovered individuals; all at instant  $t$ . Furthermore,  $\alpha$  is the net growth rate of susceptibles;  $\beta(X(t), L(t), Y(t))$  is the probability that, on meeting an actively infected person, a susceptible person becomes latently infected;  $\lambda_1$  is the natural death rate of latently infected individuals from non-disease causes;  $\lambda_2$  the proportion of the latently infected stock who becomes actively infected;  $\lambda_3$  the proportion of latently infected who recovers;  $\rho$  the proportion of actively infected who recovers and  $\omega$  the death rate of the actively infected whether through the disease or natural causes. For simplicity,  $\alpha, \lambda_i, \rho, \omega$  ( $i = 1, 2, 3$ ) are considered as constant.<sup>105</sup>

More refined models include time delays in the recovered class or examine the spread of an infectious disease which confers temporary or permanent immunity in an age structured population.

The relevance/irrelevance of time in relation with the occurrence of TB reactivation has received particular attention. Some empirical analysis<sup>106</sup> confirm that the risk of reactivation (defined as the probability per unit time for an individual who recovered from TB to develop active TB again) increases as the time pass by and reaches a peak after twelve years. This

---

<sup>105</sup>This assumption is particularly restrictive in the case of TB as it has been shown that the length of the latent period does influence the probability of TB activation. Chan-Yeung et al., 1971; Grzybowski et al., 1965.

<sup>106</sup>Castillo-Chevez, 1978; Grzybowski et al., 1965.



result claims the existence of a direct relationship between the reactivation of the disease and the length of the inactive period. On the other side, Nakielna et al. (1975) state that the difference in the risk of reactivation is only attributable to the quality of treatment received by the patient and not to the passage of time.

## 2.3 Economic Growth Theory

The study of the process of economic growth<sup>107</sup> has been a central issue in the works of classical economists such as Smith (1776), Ricardo (1817), Malthus (1798), Mill (1848) and Marx (1867). The classical analysis of the determinants of the rate of growth provides basic concepts which characterize modern theories of economic growth.

In this selective review of the literature, we discriminate between modern theories of economic growth by focusing on the neo-classical model introduced by Solow (1956) and Swan (1956). We use three central issues of growth economics to organize this work: the savings rate, technological progress and endogenous growth rate of population.

In this brief survey, only one-sector models are considered.<sup>108</sup>

The division of resources between consumption and investment is central to growth and fluctuations. This division is the result of the interaction of households' allocation of their incomes between consumption and savings and firms' investment demand, given the rates of return/interest rate and other constraints they face. The Solow-Swan<sup>109</sup> (1956) model uses a simplified setup with a composite unit (household/firm) who owns the factors of

---

<sup>107</sup>Barro and Sala-i-Martin, 1995; Burmeister and Dobell, 1970; Dorfman, 1991; Romer, 1996; Stern, 1991.

<sup>108</sup>No reference is made to other important strands of literature on economic growth theory: the two-sector and the multi-sector models. More comprehensive surveys can be found in Barro and Sala-i-Martin, 1995; Hahn and Matthews, 1964; Romer, 1996; Stern, 1991.

<sup>109</sup>Swan (1956) and Solow (1956) independently developed similar models leading to the same conclusions.



production and manages the technology to transform inputs into outputs. There are only two inputs: labour force ( $X(t)$ ) and capital ( $K(t)$ ).

Labour force is assumed to be exogenously determined and to grow at a constant rate  $n$  as

$$\dot{X}(t) = nX(t) \quad (18)$$

Capital grows as the proportion of total output flow invested and depreciates at a constant rate  $\delta$  ( $\delta > 0$ ).

$$\dot{K}(t) = sQ(t) - \delta K(t) \quad (19)$$

The proportion of output to be set aside for accumulation is determined by the savings rate ( $s$ ,  $s > 0$ ), here assumed to be exogenous and constant, and thus consumption is defined to be

$$C(t) = (1 - s)F(X(t), K(t)) \quad (20)$$

The inputs, capital and labour force, are transformed into output ( $Q$ ) according to a neoclassical production function of the form

$$Q(t) = F(X(t), K(t)) \quad (21)$$

In the absence of technological progress, the production function satisfies four properties:

1)  $F(X(t), K(t))$  exhibits positive and decreasing returns to input ( $F_X, F_K > 0$  and  $F_{XX}, F_{KK} < 0$ ).

2) The marginal product of capital (or labour) approaches infinity as capital (or labour) goes to 0 and approaches 0 as capital (or labour) goes to infinity  $\lim_{K \rightarrow 0}(F_K) = \lim_{X \rightarrow 0}(F_X) = \infty$  and  $\lim_{K \rightarrow \infty}(F_K) = \lim_{X \rightarrow \infty}(F_X) = 0$  satisfying the Inada conditions (Inada, 1963).<sup>110</sup>

---

<sup>110</sup>In some parts of the work this property does not always applied.



3)  $F(X(t), K(t))$  exhibits constant returns to scale  $F(\lambda X, \lambda K) = \lambda F(X, K)$  for all  $\lambda > 0$ ;

4) each input is essential to production in that  $F(0, K) = F(X, 0) = F(0, 0) = 0$ .

The condition of constant returns to scale allows us to express the production function in an intensive form as

$$q = f(k) \quad (22)$$

where  $q = \frac{Q}{X}$  is the per capita output and  $k = \frac{K}{X}$  is the capital-labour ratio.

Given that labour ( $X$ ) grows at a constant rate,  $n$ , as in (18) and capital per unit of labour ( $k = \frac{K}{X}$ ) accumulates according to

$$\dot{k} = sf(k) - \delta k - nk \quad (23)$$

where  $s$  is the savings rate and  $\delta$  the depreciation rate, we know that at the steady state (for  $\dot{k} = 0$ ) actual investment equals the break-even investment

$$sf(k) = (\delta + n)k \quad (24)$$

as in Fig. 6.

Furthermore, we can compare steady states in terms of their level of consumption. With  $c$  being the consumption per capita,  $(1 - s)F(X(t), K(t))/X(t)$ , we have

$$\dot{k} = f(k) - \delta k - nk - c \quad (25)$$

so that for  $\dot{k} = 0$

$$c = f(k) - (\delta + n)k \quad (26)$$



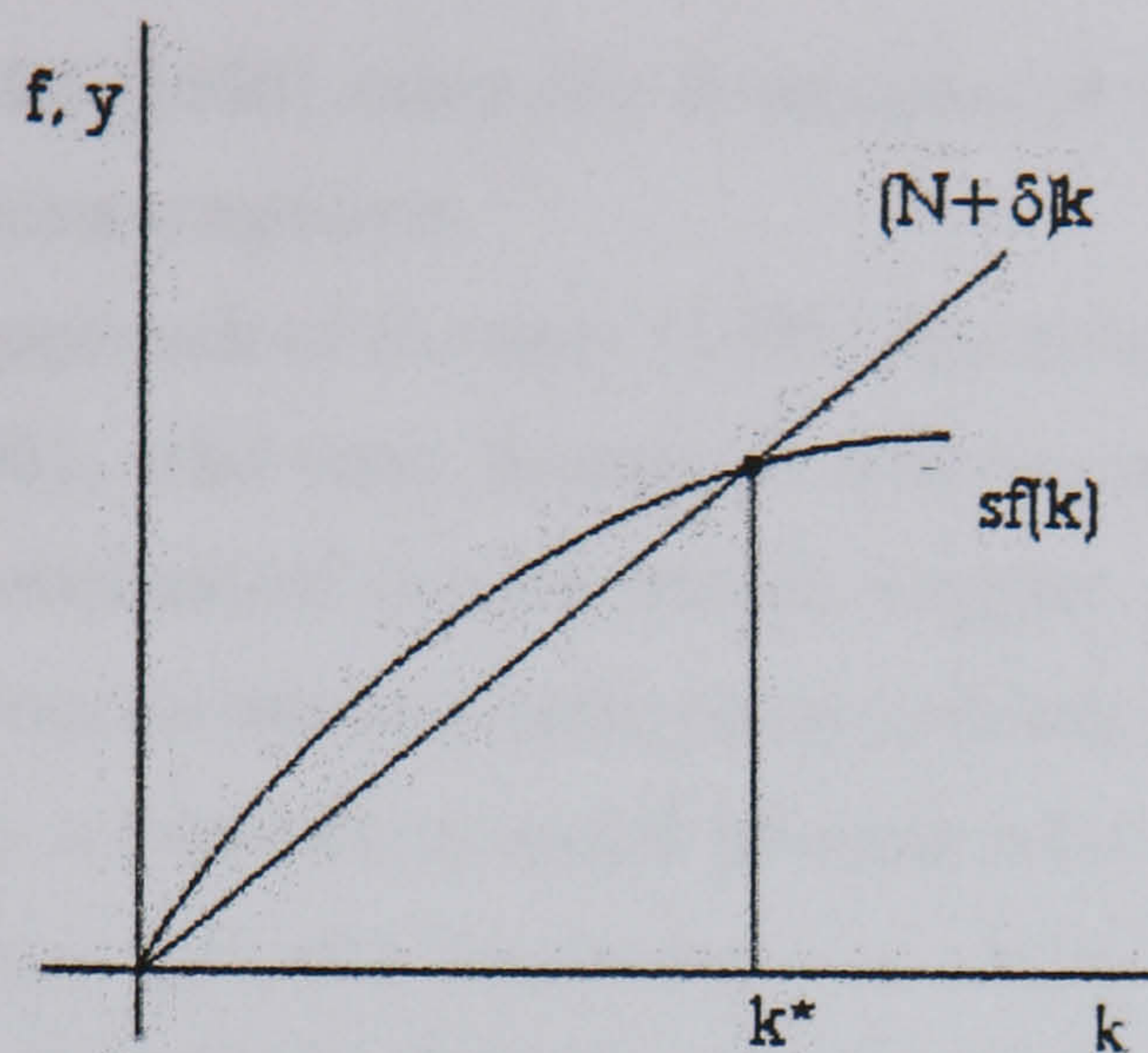

Figure 6: Actual investment and break-even investment

which is maximised at

$$f'(k) = (\delta + n) \quad (27)$$

If  $f'(k) < (\delta + n)$  then, the additional output from the increases capital per unit of labour is not enough to maintain the higher capital per unit of labour stock. If  $f'(k) > (\delta + n)$  there is more than enough additional output to maintain  $k$  at its higher level and so consumption rises. This is the capital accumulation Golden Rule. For given production function, depreciation rate and labour force growth rate, capital, according to the optimal savings rate ( $s_{GOLD}$ ), is accumulated up to the Golden Rule capital stock ( $k_{GOLD}$ ) which maximizes steady state consumption per capita ( $c = \frac{C}{X} = c_{GOLD}$ ). At the steady state the levels  $K$ ,  $X$  and  $C$  grow at the population growth rate  $n$ , exogenously determined.<sup>111</sup> Factors that can influence the steady state per capita levels are changes in the savings rate, depreciation rate and level of technology, population growth rate, all exogenously determined. Therefore,

<sup>111</sup>At the steady state, the per capita variables are constant; the steady state growth rate of  $k$ ,  $q$  and  $c$  is equal to zero.



the Solow-Swan model (1956) takes the determinants of long run per capita growth to be exogenous constants.

The pioneering approach of Ramsey (1928) and subsequently Cass (1965) and Koopmans (1965), who used Ramsey's analysis of consumer optimization back into the neoclassical growth model, suggest an alternative way to define the consumption-investment policy as a problem of optimal savings. In an economy ruled by a benevolent social planner who takes decisions about consumption over time and who maximizes the utility of the representative family, the optimal time path of consumption satisfies the Euler equation so that the rate of consumption is related to a interest rate and the rate of time preference. Subsequent interpretations of these works use a decentralized economy in which competitive households and firms are analysed. The savings rate is endogenously determined by the interaction of households and firms maximizing their utility and profit functions, respectively, subject to an intertemporal budget constraint.<sup>112</sup> The Euler equation provides the optimal savings rate which specifies the optimal proportions into which an economy's output should be divided between consumption and investment, taking account of the marginal utility of both consumption and labour, the economy's aggregate production function and the rate of time preference. The model has a simple set up based on two inputs: labour force ( $L(t)$ ) and

---

<sup>112</sup>The behaviour of the savings rate, derived from the growth rate of the consumption per capita, depends on the offsetting impacts from an intertemporal substitution effect and an income effect due to changes in the capital stock per unit of effective labour ( $\dot{k}(t)$ ). Namely, on one side, as  $\dot{k}(t)$  rises, a decline in the marginal product of capital lowers the rate of return on savings and reduces the incentive to save. The individuals are motivated to shift consumption from the future to the present. This intertemporal-substitution effect tends to lower the savings rate as the economy develops. On the other side, since individuals tend to consume a lot in relation to income, when they are poor, as  $\dot{k}(t)$  rises, the temporary income diminishes, consumption tends to fall in relation to income and the savings rate tends to raise. This income effect tends to rise the savings rate as the economy develops. The dynamic of the savings rate depends on whether the substitution or income effect prevails. Generally, the net effect is ambiguous. Barro and Sala-i-Martin, 1995.



capital ( $K(t)$ ). The labour force growth rate is still taken as exogenously determined and constant rate ( $n$ )

$$\dot{L}(t) = nL(t) \quad (28)$$

Capital depreciates at a constant rate ( $\delta$ ,  $\delta \geq 0$ ) and the rental price for a unit of capital service is  $R$  with  $(R - \delta)$  being the net rate of return to a household that owns a unit of capital.

In the 1950s and 1960s, in contrast with the Solow-Swan model (1956) where technology does not improve over time, some neoclassical economists allow for exogenously determined technological progress. There are cases of capital savings technological progress, labour savings technological progress (Harrod, 1948) and neutral technological progress (Hick, 1932). Neutral technological progress leaves unchanged the balance between labour and capital. The ratio of the marginal product of labour to the marginal product of capital does not change for unchanged  $\frac{K}{L}$ . With Harrod neutral technical progress, the production function has the form

$$Y = F(A(t)L(t), K(t)) \quad (29)$$

where the labour input is in efficiency units,  $A(t)L(t)$ . Often this is taken to grow at a determined rate ( $x$ ). Similarly, with capital savings technological progress, the marginal product of labour raises more than the marginal product of capital, given  $\frac{K}{L}$ . Capital savings technological progress has rarely been modelled in this way. More usually, capital based technological progress is considered as "embodied" in new capital.<sup>113</sup> Technological progress is assumed to be of a capital-augmenting type so that it can be represented as improvement in the quality of machinery where different machinery can be aggregated into a single measure of equivalent capital as in the case of capital savings technological progress. The labour savings technological progress

---

<sup>113</sup>Solow, 1960, 1962; Phelps, 1962.



is the opposite case.<sup>114</sup> Only labour augmented technological change or a vintage approach are consistent with the existence of a steady state in a neoclassical growth model<sup>115</sup> where the per capita variables grow in steady state at a rate of technological progress ( $x$ ).

Endogenous steady growth with convergent behaviour can also be obtained in absence of (exogenous) technological progress by relaxing the assumption of decreasing returns to capital. Non diminishing returns to capital can apply when we consider a broad definition of capital so that to include physical as well as human capital.<sup>116</sup>

Fundamental departures from the neoclassical models enrich the economic growth literature. The main innovation is the assumption of technological progress as endogenously determined. Endogenous-growth models consider capital accumulation and technical progress as influencing each other in such a way as to make the separation of the two, as assumed in the exogenous growth literature, unacceptable. The endogenous growth approach abandons the idea of technological progress as having only a residual impact on economic growth. Generally,<sup>117</sup> in this branch of literature the savings rate and the growth rate of labour force, as in Solow model, are assumed to be exogenously determined.

An alternative approach is to distinguish between physical and human capital and to consider an economy with a constant returns to scale pro-

---

<sup>114</sup>Blaug, 1963; Hahn and Matthews, 1964; Nelson, 1959; Walters, 1963.

<sup>115</sup>Barro and Sala-i-Martin, 1995.

<sup>116</sup>As in this work only one sector models are considered, physical and human capital are produced by identical production functions. Two sectors models (Lucas 1988; Rebelo, 1991; Romer 1986, 1989) allow for the more realistic possibility that physical and human capital are produced by different technologies. Non decreasing returns to scale have been neglected by neoclassical theory because of difficulties of fitting them with a perfect competition set up with marginal productivity factor pricing. Furthermore, decreasing returns to scale were more appropriate when taking into consideration the existence of a fixed supply of land, as in Meade (1961). Hahn and Matthews, 1964.

<sup>117</sup>Romer (1986) is an exception as he provides a model with knowledge accumulation, a single produced input, nonconstant returns and endogenous saving.



duction function where the existence of learning-by-doing can be seen as a form of technological progress supporting endogenous growth. The idea here is that a firm that increases its physical capital learns simultaneously how to produce more efficiently. Following Arrow (1962), Romer (1986), and Sheshinski (1967), an increase in firm's capital stock leads to an increase in its stock of knowledge and each firm's knowledge is a public good that any other firm can access at zero cost.

Other economic growth models such as Romer (1990), Grossman and Helpman (1991) and Aghion and Howitt (1992), consider capital accumulation as not central to growth. Technological advances results from purposive R&D activities to be rewarded by some form of ex-post monopoly power. Another strand of the endogenous growth literature is concerned about technological progress being stimulated by scarcity of labour (or other production factors) relatively to demand, capital or land. This literature is not considered in details here as it is generally based on a two sector framework. More comprehensive surveys can be found in Carter and Williams (1957, 1958, 1959), Nelson (1959), Barro and Sala-i-Martin (1995).

This part of the economic growth literature that analyses the forces affecting the rate of technological progress advanced our understanding of the determinants of the process of economic growth and the logic of dynamic optimization. However, the level of population (or labour force) has always been kept constant or growing at an exogenous constant rate.

Empirical findings reject the notion that the natural growth rate of population is exogenous with respect to economic growth.<sup>118</sup> An alternative way of considering population dynamics is to analyse population growth as endogenous to the economy and to consider how the prevailing economic conditions affect demographic fluctuations.

The first contribution in analysing problems of population and economic growth has been provided by Malthus (1798). In this classical framework, population growth depends on the economy's material conditions, especially

---

<sup>118</sup>Barro and Backer, 1989; Becker and Barro, 1988.



food supply. As population tends to increase geometrically while food production increases only arithmetically, growth in the biological capacity to reproduce is assumed to exceed growth in its physical capacity to produce, the so called Malthusian trap. Deviations from this trap happen only because of particular income effects on population vital rates. Specifically, the negative effect of income on fertility, the "preventive check", is supposed to operate by postponing marriage because of fear of hunger. Alternatively, income is held to affect population growth through its "positive effect" on mortality during periodic outbreaks of wars, pestilence and diseases (especially on infant mortality). The system converges towards the equilibrium income level by combining the positive relation of population growth rates to income levels and the negative relation of income to population size. The equilibrium income level, as a socially defined parameter, indicates the critical income level below which individuals would decide not to reproduce. Although Malthus' contribution assumes a perfectly elastic labour supply at a given real wage and does not provide an adequate explanation of food production,<sup>119</sup> it is the first attempt to represent population growth as endogenous to the economy.

For many decades following the classical period, the field of population studies has been neglected. During the 1960s the theory of population based on explicit micro foundations emerges in the course of economic growth as population changes due to three demographic components: fertility, morbidity/mortality and migration. Therefore, interest is focused on the economic determinants of fertility rate, morbidity/mortality rate and migration decisions. Fertility and migration theories focus on explicit family decision-making models in which optimal fertility or migration choices are made in a utility-maximizing framework. Morbidity/mortality is considered as a component of population change that may be influenced by families' decisions on the investments in human capital, in the form of health, education and nutrition.<sup>120</sup>

---

<sup>119</sup>Later described by Ricardo (1817) as due to the scarcity of land and the diminishing returns to labour.

<sup>120</sup>Examples of empirical studies in which fertility, morbidity/mortality and migration



A central issue in establishing the micro-foundations of fertility<sup>121</sup> is the parents' objective function.<sup>122</sup> Parents can have either altruistic or non-altruistic behaviour in relation to children. In the altruistic behaviour,<sup>123</sup> the main reason for having children stems from some form of interdependence between the preferences of adults and children. Parents care about the children's utility and children exist for them to experience utility. Parents then transfer resources to children to influence their utility. Such transfers affect the "child quality" mentioned above.<sup>124</sup> In the non-altruistic behaviours set up, children enter the parents' utility function either as pure "consumption goods" or as means of providing some material benefits by contributing labour services to a family business (e.g. farming) or by providing old-age security to parents.<sup>125</sup> Becker (1960)'s seminal work offers a theory of fertility in which parents have an non-altruistic behaviour towards children who are regarded as durable "consumption goods".<sup>126</sup> Furthermore, parents are assumed to have a demand both for quantity and quality of children and they obey the basic laws of demand theory. As in the case of most durable good,

---

have been analysed as dependent on economic variables, such as per capita income, wage rates, occupation, levels of female and male education, urbanization or residence in poverty area, are Barro and Lee, 1994; Behrman, 1990; Schultz, 1981.

<sup>121</sup>This literature has been extensively surveyed in Barro and Sala-i-Martin, 1995; Ehrlich and Lui, 1997; Grossman and Helpman, 1991; Hammon and Rodriguez-Clare, 1993; Raut and Srinivasan, 1994; Romer, 1989.

<sup>122</sup>As in the present study population is considered to be homogenous, contributions concerning differentials in income and fertility are excluded.

<sup>123</sup>Barro, 1974; Becker and Barro, 1988; Caldwell, 1976, 1982; Razin and Sadka, 1995; Willis, 1989.

<sup>124</sup>Becker and Barro, 1988; Razin and Sadka, 1995.

<sup>125</sup>Becker, 1960; Krishnaji, 1983; Neher, 1971; Nerlove et al., 1985; Sah, 1991; Willis, 1980.

<sup>126</sup>As Schultz (1980) points out, most studies of determinants of reproductive demands have dealt with high-income countries, and consequently consumer demand theory is emphasized. In low-income countries, children are more obviously a productive asset, at least at maturity if not always at birth. The theory of producer-derived demand for inputs might provide a framework better suited to explaining differences in fertility in developing countries.



both quantity and quality are expected to be "superior goods" and the quantity income elasticity of demand for children to be smaller than the quality income elasticity. Parents' decisions concerning the quantity of children are partly influenced by their ability to exercise birth control which is a function of their education level, conditional upon the uncertainty of conception and birth. The quality of children is supposed to be defined by the amount of resources parent spend on educating and nurturing each child. An increase in quality of each child is more expensive if there are more children because the increase has to apply to more units and an increase in quantity is more expensive if the children are of higher quality because of the higher cost of better-quality children. A positive relationship emerges between income and the rate of fertility, given a certain level of education (contraception). However, some economists<sup>127</sup> assert the existence of a negative income/fertility (quantity and quality of children) correlation. To higher level of income correspond larger bequests, investment in the quality of children, higher parents' value of time, higher shadow price of time for people who do not work for wage, higher contraception quality. All this contributes to increase the price of children and to negatively influence the fertility rate.<sup>128</sup>

A large part of the literature supports the non-altruistic motive of having children.<sup>129</sup> Where the main concern of parents is their old-age support or receiving material benefits from their children, there is a tendency of the fertility rate to increase until a minimal number of children necessary for such support/contribution is attained.

Whether altruistic or non-altruistic motives dominate has potentially important implications concerning the relationship between population dynamics and economic growth. On the one side, higher fertility, driven by an increase in income and a non-altruistic behaviour, is more likely to be observed in pre-industrial rural economies or in the developing countries. Here, formal

---

<sup>127</sup>Willis, 1989.

<sup>128</sup>Caldwell, 1976, 1982; Willis, 1986.

<sup>129</sup>Cain, 1981, 1983; Ehrlich and Lui, 1997; Entwisle and Winegarden, 1984; Jensen, 1990; Leibenstein, 1969; Nerlove et al., 1985.



education<sup>130</sup> is rare and does not raise productivity, where human capital is relatively unimportant as a form of wealth and where women's labour is more compatible with child-bearing.<sup>131</sup> On the other side, in developed economies where the main motivation for child bearing are generally of altruistic nature and fertility decisions are typically influenced by the quantity/quality trade-off, it is possible to observe a negative association of wages or incomes and fertility.<sup>132</sup>

The fertility literature based on the micro-foundations has provided a more complete population theory but has still treated income level or economic growth as exogenous variables. Becker et al. (1990) provided the first comprehensive model<sup>133</sup> of endogenous population and economic growth based on explicit micro-foundations. This model, based on a dynastic setting with altruistic motive for having children, sees parents to maximize their utility subject to available technology of producing human capital<sup>134</sup> and consumption good. Since time spent on investing in children's human capital is a choice variable for parents, growth in per capita income and consumption become an endogenous variable. As the number of children is a choice variable, fertility is also endogenised.<sup>135</sup> The model has multiple steady state equilibria (three steady-state equilibria): a stable low-level Malthusian trap, an intermediate and unstable state with economic growth and a stable state with self-sustaining economic growth. If the initial level of human capital is higher than a threshold level associated with the unstable economic growth

---

<sup>130</sup>Education effect on household behaviour can be best understood by considering time as not homogeneous and perfectly substitutable over an individual's diurnal, seasonal or life cycles. Better educated women allocate more time and interest to market-oriented activities and less time to child-rearing. Education influences the marginal productivity of labour and hence on the opportunity value of time. Schultz, 1980.

<sup>131</sup>Lee, 1997.

<sup>132</sup>Higher wages for men have led to an increase in fertility rate. Lee and Gan, 1989.

<sup>133</sup>Ehrlich and Lui (1991, 1997) extended the work of Becker et al. (1990) using a optimal intergenerational transfer framework.

<sup>134</sup>Human capital is considered here as the engine of growth. Lucas, 1988.

<sup>135</sup>The role of mortality, which is an important part of demographic transition, is not explicitly modeled here.



equilibrium, then investment in human capital becomes more worthwhile and the economy grows. If initial human capital is lower than the threshold level, the economy converges towards the Malthusian trap with a high fertility rate, no investment in children's human capital and no growth. A high fertility level is shown to be associated with a low level of human capital and income and with no growth. The optimal fertility level is shown to be lower than under both the economic growth and Malthusian trap equilibria. The existence of multiple equilibria here is used to explain the diversity of growth among countries.

Although population growth is simultaneously determined by fertility and mortality, the largest part of the literature focuses on endogenising fertility rather than mortality. However, the evidence suggests that recent trends in morbidity/mortality rates and demographic transition are just as systematic as those about fertility. Since the 1970s a substantial literature that analyses the relationship between socioeconomic factors and morbidity/mortality rates has emerged. Socioeconomic factors have mainly been viewed as an intrinsic property of individuals, such as amounts of financial and material resources that can affect morbidity/mortality rates by providing access to health care, adequacy of housing and nutrition, general living conditions, opportunities for health education and exposure to emotional stress.<sup>136</sup> Many studies have shown that morbidity/mortality are higher among people with lower socioeconomic factors. Children and adults living in inadequate socioeconomic conditions are more likely to experience poor nutritional patterns, receive limited health care, live in overcrowded and unhealthy circumstances and to be exposed to environmental risk, infection, illness and mortality. Specifically, higher education attainment,<sup>137</sup> easier access to health care services<sup>138</sup> and better occupation<sup>139</sup> have been shown to be inversely correlated

---

<sup>136</sup>Anderson et al., 1986; Feinstein, 1993; Machenback and Looman, 1993; Sorlie et al., 1995.

<sup>137</sup>Feldman, 1989; Hadley and Osei, 1982; Palmer, 1989.

<sup>138</sup>Cella et al., 1991; Walker et al., 1989; Ware et al., 1986.

<sup>139</sup>Black, 1988; Kitagawa and Hauser, 1973; Lahelma and Valkonen, 1990; Whitehead,



to morbidity/mortality rates. To residence in a poverty area<sup>140</sup> correspond higher morbidity/mortality rates generally justified by lack of basic public services and health access. Most of the literature on the socioeconomic factor influence on morbidity/mortality rates focuses on the role of income. There is a general consensus about the existence of a negative correlation between income levels and morbidity/mortality rates.<sup>141</sup> This interpretation is based on the exogeneity of income. However, when this assumption is relaxed there is no clear interpretation about the direction of influence between income and morbidity/mortality rates. This is particularly evident when we consider that people in good health have higher labour force participation rates and higher wage rates both of which lead to a greater income.<sup>142</sup> Thus it is theoretically possible that the income-morbidity/mortality rates relationship is affected by a problem of reverse causality.<sup>143</sup> Dasgupta (1997), given the existence of the phenomenon of undernourishment, stresses the impact of early nutrition and morbidity on long-term work capacity. The work of Kennedy et al. (1992) presents a comparative analysis of the health and nutritional effects of cash crop production in six developing countries. Participation in cash crop schemes results in increases in household income. Increases in income are shown to bring about improvements in pre-school health and child nutritional status.<sup>144</sup> Furthermore, it has been shown that this negative correlation between morbidity/mortality rates and income per capita is less pronounced due to the morbidity/mortality increasing effect

---

1986.

<sup>140</sup>Carstairs and Morris, 1989; Haan et al., 1987; Hadley and Osei, 1982; Silver, 1972.

<sup>141</sup>Adler et al., 1993; Cigno, 1998; Ettner, 1996; Feinstein, 1993; Hadley and Osei, 1982; Haggerty and Johnson, 1996; Kitagawa and Hauser, 1973; Kunst et al., 1990; Lutter and Morrall, 1994; Orcutt Duleep, 1985; Palmer, 1989; Silver, 1972.

<sup>142</sup>Bartel and Taubman, 1979; Ettner, 1996; Lee, 1982; Luft, 1975.

<sup>143</sup>The problem of reverse causality is less likely to occur when household wealth is considered. As wealth accumulates over time, it is less affected by a single episode of sickness. In recent studies wealth has been used as a measure of economic status. Feinstein, 1993; Palmer, 1989; Ranis et al., 2000.

<sup>144</sup>However, in the short term, increases in income must be accompanied by improvements in the health environment.



of urbanization and industrialization. This is particularly evident in many cities in the developing countries where the people, although they can experience higher income per capita than their rural counterparts, are exposed to a greater risk of morbidity/mortality due to overcrowded and polluted living conditions.<sup>145</sup>

Interpreting population growth as endogenous where economic factors affect fertility and morbidity/mortality rates contributes to a better understanding of recent trends of population dynamics. Specifically, it explains the phenomenon of demographic transition according to which developing countries have moved from a state of low/stagnant per capita income, high mortality and high fertility to a regime of persistent growth in which first mortality and then fertility are continuously declining while per capita income exhibits permanent growth.<sup>146</sup>

## 2.4 Summary

The re-emergence of TB epidemic stimulated academic research to improve the understanding of the TB dynamic transmission. As illustrated in Sections 2.2.4, 2.2.5 and 2.2.6 epidemiological modelling efforts focus almost exclusively on demographic factors or on the natural history of the disease. TB pathology has been represented by increasing complex mathematical models which include a variety of features as: birth and mortality rates, the disease transmission mechanism (Section 2.2.4), the incubation period (Section 2.2.5), the recovery and the reinfection rates (Section 2.2.6). However, the existing studies fall short of embracing the socio-economic dimension. This shortcoming is particularly evident for a disease as TB which reflects underlying social conditions of inequality and poverty.<sup>147</sup> The analysis of the

---

<sup>145</sup>Mutatkar, 1995; Phillips, 1993.

<sup>146</sup>Rostow, 1990.

<sup>147</sup>Dubos and Dubos (1987) underlined the social nature of TB: "Tuberculosis is social disease, and presents problems that transcend the conventional medical approach... its understanding demands that the impact of social and economic factors on the individual be considered as much as the mechanisms by which tubercle bacilli cause damage to the



spread and control of TB requires the adoption of a wider interdisciplinary and multisectoral perspective to complement the current merely epidemiological orientation.

In the present work we provide a general analytic model which captures the interaction between demographic-epidemiological and economic factors in the TB dynamic transmission. In order to do so, we integrate a predator-prey Lotka-Volterra type model, revised in Section 2.2.3, with the one-sector Solow-Swan (1956) economic growth model described in Section 2.3. Specifically, we divide the population into susceptible and TB infected/infectious individuals and analyse their dynamic interactions where infected people behave as predators of susceptible preys. Given the short time lag of the incubation period and that 90 per cent of the infected individuals who do not develop the active disease are part of the productive economy and can become re-infected via air with TB if exposed again to the pathogen and develop active disease, from the perspective of population transmission dynamics we consider these individuals as part of the pool of susceptibles. Generally also the recovered class is assumed to be negligible. However, in different parts of the work we allow for TB infected individuals to receive full treatment and to be cured. To analyse the economic-epidemiological interaction between the economic system and the disease we consider the demographic-epidemiological factors to be functions of economic variables. Furthermore, under the assumption that only susceptible individuals are productive, variations in labour force participation are assumed to be function of TB prevalence. Changes in the overall population size and structure are also considered by using different interpretations of the TB transmission mechanism as illustrated in Section 2.2.4. At first, the force of infection is assumed to be density dependent to indicate that in more densely populated areas the number of meeting between people is higher than in lower density areas. Subsequently, we represent situations where only the structure and not the size of the population changes with time.

---

human body”.



### 3 Prototype Model

This chapter contains a model<sup>148</sup> for the dynamic analysis of the spread of TB within a single region. In Section 3.1, referring to the predator-prey Lotka-Volterra type model used by Blower et al. (1995) and Anderson and May (1991), we analyse the transmission of infectious disease by considering only demographic and epidemiological parameters. The model developed in Section 3.2 is the first attempt in the economic-epidemiological literature to provide a general analytic framework where economic variables with demographic-epidemiological effects are included to bridge the analysis of the infectious disease dynamics and the economic process. The originality of our contribution lies in the fact that it is the first attempt that captures both variations in labour force supply as depending on the TB infectious disease dynamics and changes in demographic-epidemiological variables as function of economic variables.

The first choice we need to make is a methodological one. We need to decide the degree of complexity of the mathematical model specification and the selection of the assumptions in order to obtain insight into the basic mechanism of epidemic spread. As reported by Bailey (1975), with diseases like TB even the simplest model seems to require nine or ten categories with a much higher number of transfer-rates between categories. A model of this sort, by taking into consideration many elements, allows a very accurate comprehension of the phenomenon in question and useful quantitative conclusions. However, a high degree of complexity of the model prevents explicit analytical solutions to investigate the stability properties of ordinary differential equations. As stated in Hethcote et al. (1981a, b), when a system of differential equations in  $\mathfrak{R}^3$  is considered there is virtually no precise stability theory any more, and except for linear equations with constant coefficients, there are very few systems of differential equations that can be solved explicitly. Therefore, general conclusions of a qualitative nature re-

---

<sup>148</sup>The models considered in this work are suitable for diseases which are transmitted from person to person by contact or close proximity between infected and healthy individuals.



quire a broad and simple theoretical framework. This implies the inclusion in the model of mechanisms, in as simple as possible way, which appear to be the major components. Even simple models pose important questions with regard to the basic process and possible means of the disease epidemic. The comparative merits of simple versus complex epidemiological models are not always apparent. The type of modelling that is suitable and valid depends on circumstances.

Simplicity is chosen here to illustrate the dynamic interactions of two main classes (susceptible and TB actively infected people) and the role played by these two classes in the economic process of consumption and capital accumulation.

### 3.1 Demographic-Epidemiological Model

Historically, TB has been associated with population movements (e.g. colonization of previously non-exposed populations) and with changes in the spatial distribution of human population such as urbanization (i.e. increased community size and high population density).<sup>149</sup> As the probability of TB transmission is critically determined by the frequency and duration of an individual's contact with an infected/infectious person, it is particularly important to include the density dependent effect in the dynamic analysis of the spread of TB. In this chapter the dynamic analysis of the spread of TB is structured so that the density dependent effect enters the model through the interpersonal contact rate. From Section 2.2.4 we recall that the probability for a susceptible person becoming infected is given by the probability of meeting a TB infected individual and the probability that the meeting leads to the infection. As in more densely populated area there is a higher number of meetings between people than a lower density area, the chance of a susceptible meeting anyone else at all here is assumed to be proportional to  $N(t)$ , the overall population ( $N(t) = x(t) + y(t)$ ). The probability of infection from an

---

<sup>149</sup>McNeill, 1992; Wilson, 1995; Susser, 1994; Wallace and Wallace, 1993; Wallace et al., 1995.



encounter between a TB infected and a susceptible individual, given equally likely meeting between any two people,<sup>150</sup> is represented by  $\beta$ . Furthermore,  $\frac{y(t)}{x(t)+y(t)}$  is the probability of meeting an infected person. Given the number of susceptible individuals,  $x(t)$ , and this transmission mechanism, the TB force of infection is overall given by

$$\frac{\beta x(t) y(t) N(t)}{N(t)} \quad (30)$$

or more simply by

$$\beta x(t) y(t) \quad (31)$$

We consider a homogeneously mixing population<sup>151</sup> of  $N(t)$  individuals in a given area at time  $t$  ( $t \geq 0$ ) which is divided into two classes according to their health status: healthy susceptible ( $x(t)$ ) and TB infected/infectious ( $y(t)$ ) individuals. As time progresses the population dynamics is represented by a predator-prey Lotka-Volterra type system of two differential equations that represent the class of the susceptible ( $x(t)$ ) and TB infected/infectious individuals ( $y(t)$ ), respectively.

$$\begin{cases} \dot{x}(t) = \alpha x(t) - \beta x(t) y(t) \\ \dot{y}(t) = \beta x(t) y(t) - \omega y(t) \end{cases} \quad (32)$$

where a susceptible individual can either stay susceptible or moving out of the susceptible class to enter the actively TB infectious/infected one when infected by an already actively TB infected individual. Here,  $\alpha$  is the net

---

<sup>150</sup>The TB transmission coefficient,  $\beta$ , is usually assumed to be constant; for different diseases it may be function of individual features (the age of the healthy person) or chance of encounter (the plague usually spread through fleas passing from one person to another). Here, no specific improvements in TB control are assumed. Philipson, 1995.

<sup>151</sup>The population considered here is assumed sufficiently large so that the sizes of each class can be considered as continuous variables.



growth rate of susceptible individuals (birth rate minus death rate),<sup>152</sup>  $\omega$  the mortality rate of TB infected individuals inclusive of both the TB-induced death rate and the other-than-TB death rate.

The demographic movements of the population (dictated by  $\alpha$  and  $\omega$ ) and the spread of TB infection (dictated by  $\beta$ ) are here exogenously determined and constants. Our model derives from the predator-prey Lotka-Volterra type model used by Blower et al. (1995). It consists of three differential equations here simplified into an autonomous system in  $\mathfrak{R}^2$  of two nonlinear (quadratic) ordinary differential equations where the latent class is ignored as considered negligible.<sup>153</sup> Furthermore we depart from the Blower et al. (1995) model in that we assume the net growth rate of the susceptible class occurs at a rate ( $\alpha$ ) proportional to the susceptible population level ( $x(t)$ ). There is a long historical tradition of treating population growth as geometric rather than arithmetic.

The transmission dynamic of TB is investigated by making use of the theory of nonlinear dynamical systems. If the demographic-epidemiological parameters ( $\alpha$ ,  $\beta$  and  $\omega > 0$ ) are constants, the equilibrium or stationary state population levels ( $x^*$ ;  $y^*$ ) are solutions of the static equations  $\dot{x}(t) = 0$  and  $\dot{y}(t) = 0$ , which, from the (32) system can be easily shown to be

$$(x_1^*; y_1^*) = \left( \frac{\omega}{\beta}; \frac{\alpha}{\beta} \right) \quad (33)$$

and

---

<sup>152</sup>The actively TB infected people growth rate, given exclusively by the force of the infection (no offsprings of actively TB infected people are assumed), constitutes a sensible alternative assumption to the "numerical response" (or predator birth rate assumed to be linearly proportional to the prey abundance in the Lotka-Volterra type models).

<sup>153</sup>The absence of latent and recovered class is representative of situations in which, when a susceptible is infected, he/she becomes immediately infectious and in which a low recovery rate is counterbalanced by an high probability of being infected. Although these assumptions are rather simplified, they would in fact be approximately applicable to the situation where the disease is highly infectious and sufficiently serious for cases to be withdrawn by death or isolation. See Section 2.2.5.



$$(x_2^*; y_2^*) = (0; 0) \quad (34)$$

As negative solutions have no demographic-epidemiological significance, only cases where  $x^*, y^* \geq 0$  are considered. From the analysis of the stationary states, it can be observed that, at the equilibrium point (33) the susceptible individuals level is independent of its net growth rate and it is a function of the total death rate of the actively TB infected individuals ( $\omega$ ). Similarly, at the equilibrium point (33), the actively TB infected individuals level is independent of its total death rate but it is a function of the susceptible net population growth rate ( $\alpha$ ). Both equilibrium levels of susceptible and actively TB infected people in (33) depend on the TB transmission coefficient,  $\beta$ . At the stationary state, the presence of actively infected individuals ( $y^* \neq 0$ ) means that the susceptible population is just sufficient to equate the force of infection ( $\beta x^*$ ) to the total mortality of actively TB infected individuals ( $\omega$ ). Likewise, a nonnegative stationary state level of susceptible population ( $x^* \neq 0$ ) exists only when the net population growth rate ( $\alpha$ ) and force of infection ( $\beta y^*$ ) are equal.<sup>154</sup>

Local stability analysis, applicable to infinitesimally small fluctuations from the stationary states, is carried out to determine the stability properties of the system around its stationary points. A Taylor expansion series about the stationary state gives a Jacobian of

$$\begin{bmatrix} \alpha - \beta y & -\beta x \\ \beta y & \beta x - \omega \end{bmatrix} \quad (35)$$

---

<sup>154</sup>From (32) we know that, for  $\dot{x} = 0$  and  $\dot{y} = 0$ , we have

$$x^*(\alpha - \beta y^*) = 0 \quad (f1)$$

and

$$y^*(\beta x^* - \omega) = 0 \quad (f2)$$

from which, for  $x^* \neq 0$  and  $y^* \neq 0$ , we require  $\alpha = \beta y^*$  and  $\omega = \beta x^*$ , respectively.



where  $x$  and  $y$  are now measured as deviations from a particular stationary point and derivatives in the Jacobian are evaluated at that stationary point. By linearizing about the first stationary state (33), (35) becomes

$$\begin{bmatrix} 0 & -\omega \\ \alpha & 0 \end{bmatrix} \quad (36)$$

from which it follows that the eigenvalues are

$$\eta_{1,2} = \pm\sqrt{-\alpha\omega} \quad (37)$$

By linearizing about the second stationary state (34), the Jacobian in (35) becomes

$$\begin{bmatrix} \alpha & 0 \\ 0 & -\omega \end{bmatrix} \quad (38)$$

from which it follows that the eigenvalues are

$$\eta_1 = \alpha \text{ and } \eta_2 = -\omega \quad (39)$$

The analysis of the signs of the eigenvalues and eigenvectors is required to understand the local dynamics of the system. The first stationary point (33) has two pure imaginary roots and thus it is characterized by a centre (closed cycles).<sup>155</sup> The second stationary point (34) has two real and distinct eigenvalues with different sign so that the origin is a saddle point.<sup>156</sup> Next it is useful to piece together this local dynamic information to represent the solutions as orbits to get a global view of the phase-plane.<sup>157</sup> The results are as in Fig. 4 in the previous chapter.

---

<sup>155</sup>If we assume  $\alpha < 0$  we have a saddle point as the eigenvalues are real and distinct but of opposite sign. The case of  $\alpha = 0$  is a degenerate case.

<sup>156</sup>For  $\alpha < 0$  we have a node (positive attractor) as the eigenvalues are real and distinct but with the same sign. The case of  $\alpha = 0$  is a degenerate case.

<sup>157</sup>The phase-plane is the set of all points  $x(t)$  and  $y(t)$  and has two dimensions. The orbit is the path, or trajectory, traced out in the phase-plane at  $t$  varies.



Stability analysis predicts that the solutions in the neighbourhood of the first equilibrium point (33), for  $\alpha > 0$ , are periodic in  $t$  with period approximately equal to  $\frac{2\pi}{\sqrt{\alpha\omega}}$ . The period is inversely proportional to the square root of the product between the net susceptible population growth rate and the total death rate of the actively TB infected individuals. Therefore, larger net susceptible population growth rate and/or total actively TB infected individuals death rate, result in more rapid cycles. The amplitude is defined uniquely by the initial conditions that entirely determine which of the infinite number of cycles is actually followed. As in the Lotka-Volterra model, the system illustrated here in proximity of the steady state (33) has a particular dynamic property: neutral stability. Any small perturbation of the initial conditions moves the solution into another similar neutrally stable trajectory, with the same period but with a new amplitude defined by the disturbance. Furthermore, it can be shown that the solution to (32) consists of the set of closed curves<sup>158</sup>

$$\omega y - \beta (y - \ln x) - \alpha \ln y = \text{constant} \quad (40)$$

around the first steady state (33), and so the population never becomes extinct. This statement excludes the possibility that an infectious disease can be automatically eradicated. The second stationary state (34) is often<sup>159</sup> not considered in the original Lotka-Volterra model since the analysis is limited to a phase plane where  $x(t)$  and  $y(t)$  are strictly positive. The equilibrium point which corresponds to the origin of the axis is included in this study as all possible solutions approaching the equilibrium point from the quadrant,

---

<sup>158</sup>With reference to the Lotka-Volterra model reviewed in Section 2.2.3, the set of closed curves is

$$dy + by - c \ln x - a \ln y = \text{constant} \quad (f3)$$

<sup>159</sup>Few exceptions are represented by May (1985) and Medio, Gallo (1992).



where  $x(t)$  and  $y(t)$  are nonnegative, are of interest in indicating the paths of approach to extinction.

### 3.1.1 Calibration

Given the shortcomings of the linearisation methods in that the generality of nonlinear systems escapes full analytical investigation, the best research strategy that can be employed is a combination of analytical and numerical investigations. Numerical analysis requires parameter values. To give the analysis empirical relevance we calibrate the nonlinear system for a specific parameter sets. This means our numerical calibration should have direct empirical relevance for particular countries; taken to an extreme, we can predict the long run prevalence of TB and the time interval in which this will be approached. Of course this depends on the accuracy of our calibration. In what follows we calibrate the non-linear system for a variety of data sets (Table 3.1) from the World Bank (WB) and World Health Organization (WHO) sources<sup>160</sup> with the goal of simulating the quantitative nature of the population dynamics of (32). We use data on GNP per capita, total population size, crude birth and death rates, TB mortality rate, TB prevalence and TB treatment success rate on a sample of 191 countries grouped in six demographic regions according to the classification provided by WHO. Because of lack of data for the TB transmission coefficient,  $\beta$  has been estimated<sup>161</sup> by using the equation in (32) where  $p$  is represented by TB prevalence over total population as in Table 1. We group countries following the six demographic World Health Organization Regions classification and calculate the

---

<sup>160</sup>World Bank, 2000; World Health Organization, 2000b, d.

<sup>161</sup>Specifically, to calibrate  $\beta$  we assume that, in the long-run, there is no growth in TB infected. The long run possibilities are that either the system approaches a non degenerated steady state or the population itself becomes extinct or the disease is eradicated. In each case  $\frac{\dot{y}(t)}{y(t)} = 0$ . From (32) we set

$$\frac{\dot{y}(t)}{y(t)} = \left[ \frac{\beta}{(1+p)} - \omega \right] = 0 \quad (\text{f4})$$

where total population is normalised to be unity. From (f4) follows that  $\beta = \omega(1+p)$ .



average of each variable across each region. The WHO demographic regions are: African Region<sup>162</sup> (AFR), Region of the Americas<sup>163</sup> (AMR), South-East Asia Region<sup>164</sup> (SEAR), European Region<sup>165</sup> (EUR), Eastern Mediterranean Region<sup>166</sup> (EMR) and Western Pacific Region<sup>167</sup> (WPR). GNP per capita is

---

<sup>162</sup>Countries which belong to the African Region are: Algeria, Angola, Benin, Botswana, Burkina Faso, Burundi, Cameroon, Cape Verde, Central African Republic, Chad, Comoros, Congo, Cote d'Ivoire, Equatorial Guinea, Eritrea, Ethiopia, Gabon, Gambia, Ghana, Guinea, Guinea-Bissau, Kenya, Lesotho, Liberia, Madagascar, Malawi, Mali, Mauritania, Mauritius, Mozambique, Namibia, Niger, Nigeria, Rwanda, Sao Tome and Principe, Senegal, Seychelles, Sierra Leone, South Africa, Swaziland, Togo, Uganda, United Republic of Tanzania, Zambia, Zimbabwe.

<sup>163</sup>Countries which belong to the Region of the Americas are: Antigua and Barbuda, Argentina, Bahamas, Barbados, Belize, Bolivia, Brazil, Canada, Chile, Colombia, Costa Rica, Cuba, Dominica, Dominican Republic, Ecuador, El Salvador, Grenada, Guatemala, Guyana, Haiti, Honduras, Jamaica, Mexico, Nicaragua, Panama, Paraguay, Peru, Saint Kitts and Nevis, Saint Lucia, Saint Vincent and the Grenadines, Suriname, Trinidad and Tobago, United States of America, Uruguay.

<sup>164</sup>Countries which belong to the South-East Asia Region are: Bangladesh, Bhutan, Democratic People's Republic of Korea, India, Indonesia, Maldives, Myanmar, Nepal, Sri Lanka, Thailand.

<sup>165</sup>Countries which belong to the European Region are: Albania, Andorra, Armenia, Austria, Azerbaijan, Belarus, Belgium, Bosnia and Herzegovina, Bulgaria, Croatia, Czech Republic, Denmark, Estonia, Finland, France, Georgia, Germany, Greece, Hungary, Iceland, Ireland, Israel, Italy, Kazakhstan, Kyrgyzstan, Latvia, Lithuania, Luxembourg, Malta, Monaco, Netherlands, Norway, Poland, Portugal, Republic of Moldova, Romania, Russian Federation, San Marino, Slovakia, Slovenia, Spain, Sweden, Switzerland, Tajikistan, The former Yugoslav Republic of Macedonia, Turkey, Turkmenistan, Ukraine, United Kingdom, Uzbekistan, Yugoslavia.

<sup>166</sup>Countries which belong to the Eastern Mediterranean Region are: Afghanistan, Bahrain, Cyprus, Djibouti, Egypt, Iraq, Jordan, Kuwait, Lebanon, Libyan Arab Jamahiriya, Morocco, Oman, Pakistan, Qatar, Saudi Arabia, Somalia, Sudan, Syrian Arab Republic, Tunisia, United Arab Emirates, Yemen.

<sup>167</sup>Countries which belong to the Western Pacific Region are: Australia, Brunei Darussalam, Cambodia, China, Cook Islands, Japan, Kiribati, Lao People's Democratic Republic, Malaysia, Marshall Islands, Mongolia, Nauru, New Zealand, Niue, Palau, Papua New Guinea, Philippines, Republic of Korea, Samoa, Singapore, Solomon Islands, Tonga, Tuvalu, Vanuatu, Viet Nam.



included here as an indicator of the level of prosperity for the year 1998. Total population size estimates are based on national population censuses. Frequency and quality of censuses vary by country (about 85 per cent conducted a census between 1989 and 1999) and 1998 estimates are intra/extrapolations based on demographic models. Crude birth and death rates are the number of births and deaths occurring during the year and derived from birth and death registration systems, censuses and sample surveys conducted by national statistical offices, United Nations agencies and other organizations. The estimates for 1998 for many countries are based on extrapolations of levels and trends measured in earlier years. The TB death rate indicates the number of people who died because of TB in 1998. TB prevalence refers to the number of people suffering from TB in 1997. We obtained the net growth population rate by subtracting the crude death rate from the crude birth rate. Furthermore, we calculated the total death rate for the TB infected individuals by adding the crude death rate to the TB death rate. The African region, although having the lowest GNP per capita, presents the highest net growth population rate and the lowest TB treatment success rate for a medium-high level of TB prevalence over total population and a medium TB death rate. The South-East Asia Region is similar to the African Region in the level of TB prevalence over total population, the TB death rate and the GNP per capita. However, South-East Asia Region is characterized by a higher net growth population rate. The European Region and the Region of Americas, as groups of 'mature' countries, have common features as the highest GNP per capita, the lowest TB death rate and TB prevalence over total population. However, the net growth population rate is low in European Region and high in Region of Americas. The East Mediterranean Region and the West Pacific Region, tend to come out as average countries on measures of the GNP per capita, the net growth population rate and the TB prevalence over total population.

To represent the case of demographic-epidemiological model without recovery and latent class with a density dependent TB transmission mecha-



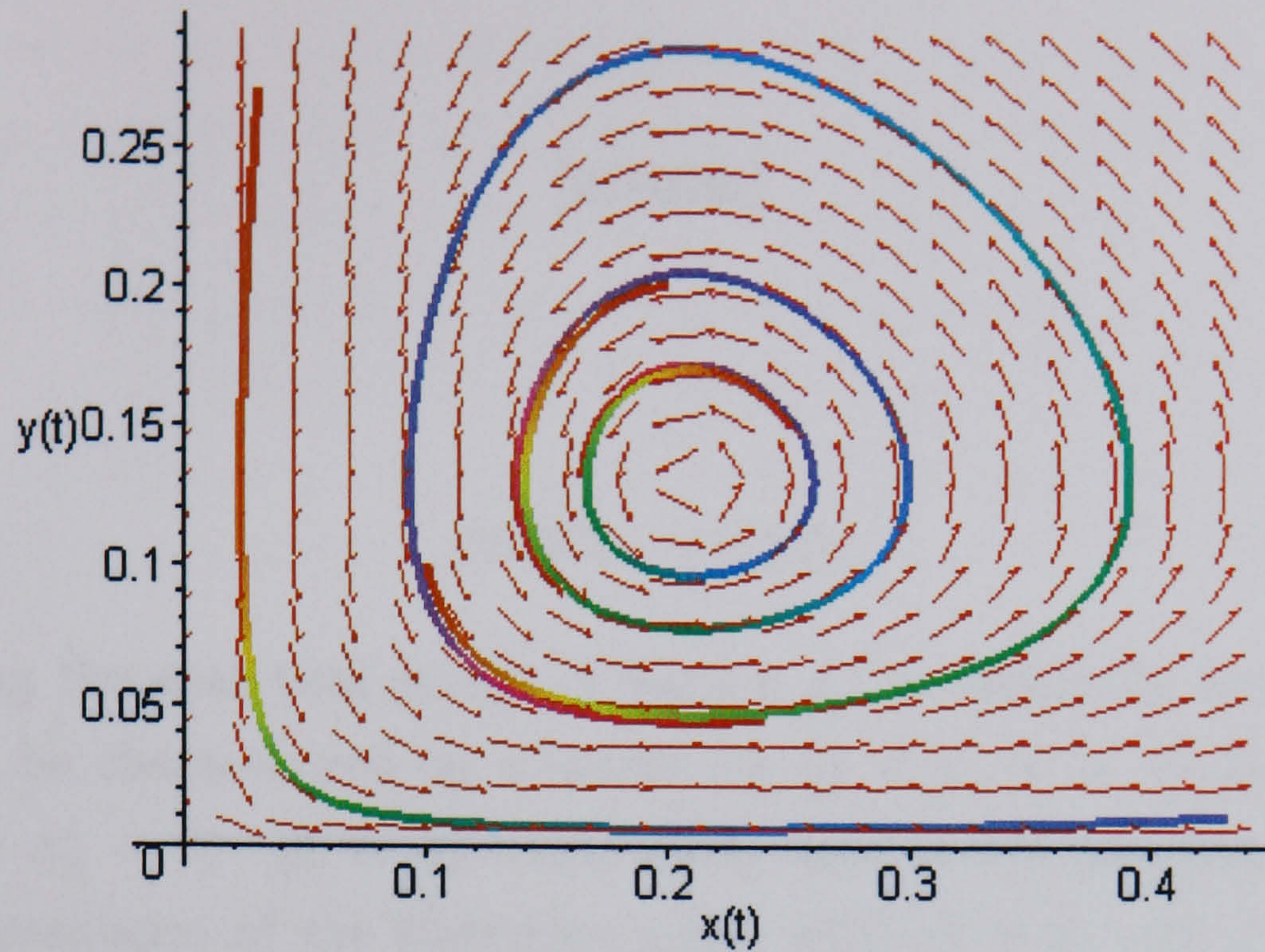

Figure 7: Global phase-plane diagram, demographic-epidemiological model nism, data have been taken from the African region:  $\alpha = 0.023$ ,  $\beta = 0.177$ ,  $\omega = 0.037$ . With these parameter values the net population growth rate of the healthy people is 2.3 per cent, the TB transmission coefficient 17.7 per cent and the total death rate of the infected individual 3.7 per cent. Results are shown in the phase diagram plotted in Fig. 7.

We can observe that the system in (32) with these specific parameter values has two stationary points at

$$(x_1^* = 0.209, y_1^* = 0.130) \quad (41)$$

and

$$(x_2^* = 0, y_2^* = 0) \quad (42)$$

Given the calibrated values, the eigenvalues around the two stationary points are, respectively,



$$[\pm 0.029i] \tag{43}$$

and

$$[0.023, -0.037] \tag{44}$$

confirming the analytical results of Section 3.1 in which the system (32) is found to be characterized by a centre (at  $x_1^* \neq 0$ ,  $y_1^* \neq 0$ ) and a saddle point (at  $x_2^* = 0$ ,  $y_2^* = 0$ ), respectively with a TB prevalence of 0.622 in correspondence of the stationary point with  $x_1^* \neq 0$ ,  $y_1^* \neq 0$ . Notice that in this model the scale of the total population is set by demographic-epidemiological parameters.

### 3.2 Economic-Epidemiological Model

In this section we provide a model which captures the two-way interaction between the spread of infectious disease and the economic system where susceptible and TB infected individuals take part in the process of consumption and capital investment. We explicitly refer to the Solow-Swan model (1956) with exogenous savings and absence of technological progress to represent the process of capital accumulation and economic growth.<sup>168</sup> However, we introduce two major modifications so that the model represents the interaction between demographic-epidemiological and economic factors in a TB dynamic transmission setting. First, as we believe that general prosperity, by bringing improvements in housing and working conditions, diet, transport and health infrastructure, affects the demographic-epidemiological fluctuations, the population growth rate here is assumed to be endogenously determined. The net growth rate of the healthy population ( $\alpha$ ), the TB transmission coefficient ( $\beta$ ) and the mortality rate of the infected individuals ( $\omega$ ) are no

---

<sup>168</sup>Any monetary mechanism is excluded.



longer constant but are functions of economic variables. Secondly, as we acknowledge the existence of feedback effects of TB infectious disease on the labour force participation rates, only healthy individuals are assumed to be capable of working and to be participating in the production process. The prevalence of TB infection affects the dynamics of the total population and induces variations in labour force participation. A high (low) proportion of infected leads to low (high) levels of output and economic prosperity *ceteris paribus*.<sup>169</sup>

This work considers an economy composed of a population with two disjoint classes, the TB actively infected individuals ( $y(t)$ ) and the susceptible ( $x(t)$ ), the latter producing a unique good that can be either consumed or invested. The total output<sup>170</sup> ( $F(x(t), k(t))$ ), produced only by the susceptible individuals ( $x(t)$ ) and by homogenous capital ( $k(t)$ ), can be split up into consumption ( $C(t)$ ) plus capital formation ( $\dot{k}(t)$ ) and written as

$$F(x(t), k(t)) = C(t) + \dot{k}(t) \quad (45)$$

Therefore, the production process, described by means of an aggregate production function, takes the general form

$$Q = F(x(t), k(t)) \quad (46)$$

where  $Q$  represents the maximum amount of output that can be produced using input factors as capital ( $k(t)$ ) and labour ( $x(t)$ ). The production function is assumed to satisfy the neoclassical properties:

- 1)  $F(x(t), k(t))$  exhibits positive and decreasing returns to input ( $F_x, F_k > 0$  and  $F_{xx}, F_{kk} < 0$ ).

---

<sup>169</sup>This ignores the possibility of investment in capital.

<sup>170</sup>The conventional Ramsey-Solow simplification is assumed: the production of consumption output ( $C(t)$ ) and of the capital formation ( $\dot{k}(t)$ ) involves the same capital-labour factor intensities.



2) The marginal product of capital (or labour) has finite limits as capital (or labour) goes to 0 and approaches 0 as capital (or labour) goes to infinity. Later in a parametric example we use a CES function with elasticity of substitution less than one.<sup>171</sup>

3)  $F(x(t), k(t))$  has homogeneity of degree one, from which constant returns to scale follow  $F(\lambda x, \lambda k) = \lambda F(x, k)$  for all  $\lambda > 0$ .

4) each input is essential in that  $F(0, x(t)) = F(k(t), 0) = F(0, 0) = 0$ .

The savings function is assumed to determine the composition of demand as between output to be consumed and output to be set aside for accumulation. Specifically, a fraction  $s$  of total output flow ( $F(x(t), y(t))$ ) is assumed to be saved and set aside to be added to the capital stock. The fraction of output devoted to investment,  $s$ , is assumed to be exogenous, positive and constant. Furthermore, existing capital is assumed to depreciate at rate  $\phi$  with  $\phi \in [0, 1]$ . In a decentralized system where capital is equally owned by each individual either susceptible or TB infected/infectious we can think of

$$I_x = \psi x + r k_x \quad (47)$$

and

$$I_y = r k_y \quad (48)$$

being the income of the susceptible and TB infected/infectious individuals, respectively, with  $k_x = \frac{x}{x+y}k$  and  $k_y = \frac{y}{x+y}k$ . There is a competitive rental market for capital with rental price  $r$  and competitive labour market wage  $\psi$ , all measured in units of output. The susceptible and TB infected/infectious individuals have propensity to save out of their income of  $s_x$  and  $s_y$ , respectively. The total savings is

$$s = s_x I_x + s_y I_y \quad (49)$$

---

<sup>171</sup>This is in contrast with the assumption made in Section 2.3.



By assuming

$$s_x = s_y = s \quad (50)$$

then

$$s = s(I_x + I_y) = s(\psi x + rk_x + rk_y) = sF(k(t), x(t)) \quad (51)$$

we are back to the central planned model.

The growth of the capital stock<sup>172</sup> is given by the equation

$$\dot{k}(t) = s F(k(t), x(t)) - \phi k(t) \quad (52)$$

with  $k(0) > 0$ .

Equation (52) states that the rate of change of the capital stock is the difference between two terms. The first,  $s F(k(t), x(t))$ , is actual investment: output is  $F(k(t), x(t))$ , and the fraction of that output that is invested is  $s$ . The second term,  $\phi k(t)$ , is the amount of capital which is depreciated. In Solow's words, the second term represents the *break-even investment*, the amount of investment that must be done just to keep  $k(t)$  at its existing level. When actual investment exceeds the investment needed to break even,  $k(t)$  is rising. Viceversa,  $k(t)$  is falling. When the two are equal,  $k(t)$  is constant.

As only susceptible individuals are assumed to enter the labour force, capital per healthy worker,  $\frac{k(t)}{x(t)}$ , is chosen here as a measure for economic prosperity as only susceptible individuals are assumed to enter the labour force. To higher levels of  $\frac{k(t)}{x(t)}$  correspond lower levels of TB transmission coefficient ( $\beta'(\frac{k(t)}{x(t)}) \leq 0$ ) and total death rate of the infected individuals

---

<sup>172</sup>In the dynamic transmission model, the variables  $k(t)$  and  $x(t)$  refer to stocks of assets - stocks of capital and labour, respectively. However, the arguments  $k(t)$  and  $x(t)$ , entering the production function, refer to flow rates of inputs of services of these assets. The foregoing notation is a shorthand in which a utilization factor, showing the rate at which service is rendered by each asset stock, has been omitted. The dynamic transmission equations deal with the variables  $k(t)$  and  $x(t)$  as stock variables, whereas the arguments of the production function are flow rates of asset services.



$(\omega'(\frac{k(t)}{x(t)}) \leq 0)$ .<sup>173</sup> Higher  $\frac{k(t)}{x(t)}$  represents, here, improvements in general standards of living and working conditions, diet, education, availability and access to health services which reduce both the transmission coefficient and the mortality rate of the infected individuals. Notice that a special case of this would make the demographic-epidemiological parameters functions of consumption per healthy worker. There is contrasting evidence about the behaviour of the net growth rate of the susceptible individuals as at low levels of wealth, there is evidence that the net birth rate increases with prosperity but for higher levels of wealth the reverse is the case<sup>174</sup>. Here, as we are dealing with low income countries, it is reasonable to assume that the net birth rate of the susceptible individuals is a non decreasing function of  $\frac{k(t)}{x(t)}$  ( $\alpha'(\frac{k(t)}{x(t)}) \geq 0$ ).

The two-way interactions between demographic-epidemiological factors and economic variables in the transmission dynamic of TB in a population of susceptible,  $x(t)$ , and TB actively infected individuals,  $y(t)$ , where capital stock,  $k(t)$ , changes with time, is described by an autonomous system in  $\mathfrak{R}^3$  of three non-linear differential equations

$$\begin{cases} \dot{x}(t) = \alpha x(t) - \beta x(t)y(t) \\ \dot{y}(t) = \beta x(t)y(t) - \omega y(t) \\ \dot{k}(t) = s F(k(t), x(t)) - \phi k(t) \end{cases} \quad (53)$$

where, because of the assumption of constant returns to scale/homogeneity of degree one,

$$\frac{F(k(t), x(t))}{x(t)} = F\left(\frac{k(t)}{x(t)}, 1\right) = f\left(\frac{k(t)}{x(t)}\right) \quad (54)$$

The system in (53) in absence of capital ( $k = 0$ ), reduces to the original predator-prey Lotka-Volterra type model. For  $\beta = \omega = 0$  or  $y = 0$ , (53) reduces to the one-sector Solow-Swan model.

---

<sup>173</sup>Adler et al., 1993; Cigno, 1998; Ettner, 1996; Feinstein, 1993; Hadley and Osei, 1982; Haggerty and Johnson, 1996; Kitagawa and Hauser, 1973; Kunst et al., 1990; Lutter and Morrall, 1994; Orcutt Duleep, 1985; Palmer, 1989; Silver, 1972.

<sup>174</sup>Lee, 1987.



To analyse the stability properties of the system (53) we find the equilibrium points by solving the static equations  $\dot{x}(t) = 0$ ,  $\dot{y}(t) = 0$  and  $\dot{k}(t) = 0$ . As the demographic-epidemiological factors,  $\alpha$ ,  $\beta$  and  $\omega$ , are constant when  $x(t)$  and  $k(t)$  are, there are three<sup>175</sup> stationary states<sup>176</sup>

$$\left( x_1^* = \frac{\omega}{\beta}; y_1^* = \frac{\alpha}{\beta}; \left( \frac{k}{x} \right)_1^* = \tilde{f}^{-1} \left( \frac{\phi}{s} \right) \right) \quad (55)$$

$$\left( x_2^* = \frac{\omega}{\beta}; y_2^* = \frac{\alpha}{\beta}; k_2^* = 0 \right) \quad (56)$$

$$(x_3^* = y_3^* = k_3^* = 0) \quad (57)$$

Here,  $\tilde{f}^{-1} \left( \frac{\phi}{s} \right)$  is the inverse function of  $\tilde{f}$ . It is easy to see that in the system (53) there is no balanced path along which  $x(t)$ ,  $y(t)$  and  $k(t)$  each grow at a constant rate<sup>177</sup>  $\varphi$ . However, we acknowledge the existence of a partially balanced growth path with  $y \equiv 0$  and  $\frac{k(t)}{x(t)}$  constant solving  $\alpha(z(t)) =$

---

<sup>175</sup>From (53) we know that for  $\dot{k} = 0$

$$s F(k(t), x(t)) = \phi k(t) \quad (f5)$$

from which we have  $s F\left(\frac{k(t)}{x(t)}, \frac{x(t)}{x(t)}\right) = \phi \frac{k(t)}{x(t)}$  or if  $\tilde{f}\left(\frac{k(t)}{x(t)}\right) = F\left(\frac{k(t)}{x(t)}, 1\right) / \frac{k(t)}{x(t)}$  then  $s \tilde{f}\left(\frac{k(t)}{x(t)}\right) = \phi$  so that  $\left(\frac{k(t)}{x(t)}\right)^* = \tilde{f}^{-1}\left(\frac{\phi}{s}\right)$ .

<sup>176</sup>Whether the origin is an admissible stationary state depends on whether the demographic-epidemiological parameters have well defined values at  $k(t) = x(t) = 0$ . If  $\beta = 0$  identically then the system reduces to the Solow-Swan single sector growth model in  $(x(t), k(t))$  with the infected dying out gradually through time. If  $\alpha, \beta$  and  $\omega$  are constants then we still have three stationary states. The variation from the Solow-Swan model is that  $x(t)$ , the productive labour force, displays cycles and, therefore, there is no steady state growth path. In this case there are still three stationary states: the first of these has one negative real and two purely complex conjugate roots like the second whilst the third still has three real roots. If  $\phi = 0$  then there are no stationary points and no steady state growth paths.

<sup>177</sup>If there were a balanced growth path  $\varphi$  then (53) would require



$s\tilde{f}(z(t)^{-1}) - \phi$  where for  $z(t) = \frac{k(t)}{x(t)}$  and  $\tilde{f}(z(t)) = F(1, z(t)^{-1})$ . Along this path the growth rate of  $x(t)$  and  $k(t)$  is  $\alpha(z(t))$  and there is no disease in the system. For any initial condition on this path the disease cannot break out. For initial conditions starting away from this path, the central question is to know under what conditions the time path of the system approaches this disease free balanced growth time profile. A necessary condition for this is that  $\frac{\dot{y}(t)}{y(t)}$  eventually becomes and stays negative. However, as  $y(t) \rightarrow 0$ ,  $\frac{\dot{x}(t)}{x(t)} \rightarrow \alpha > 0$  it follows that  $x(t)$  grows asymptotically at a positive rate  $\alpha$ . As  $\frac{\dot{y}(t)}{y(t)} = (\beta x(t) - \omega)$  where  $\beta$  and  $\omega$  are finite and positive, it follows that it is impossible for  $\frac{\dot{y}(t)}{y(t)}$  to ultimately remain negative as  $t \rightarrow \infty$  because  $x$  is growing. The result is that the system cannot eradicate the disease.

Interest then focuses on how the interaction of the economic growth system with the demographic-epidemiological process controls the dynamics of the population structure and economic prosperity.

In the first stationary point (55), there is a nontrivial economic process, while in the second and third stationary points, (56) and (57) respectively, the economy is irrelevant. When the stationary point does not involve extinction of the whole population as in (55) and (56), the prevalence of the disease, represented by  $\frac{y(t)}{x(t)}$ , is given by  $\frac{\alpha}{\omega}$ . As reported in most empirical studies, the mortality rate of the infected people is inversely related with prosperity.<sup>178</sup> Assuming that the net birth rate of susceptible individuals ( $\alpha$ ) increases with prosperity, productive capital has an increasing effect on the stationary point disease prevalence. If  $\alpha$  is assumed to fall with prosperity, the effect depends on the relative sign of  $\alpha$  and  $\omega$ .

---

$$\begin{cases} \varphi = \alpha - \beta y(t) \\ \varphi = \beta x(t) - \omega \end{cases} \quad (\text{f6})$$

where along the balanced growth path  $\alpha$ ,  $\beta$  and  $\omega$  would be constants. But then setting  $y(t) = y(0)e^{\varphi t}$ , the only value of  $\varphi$  that satisfied (53) for all  $t$  is  $\varphi = 0$ .

<sup>178</sup>Anderson et al., 1986; Cella et al., 1991; Feinstein, 1993; Feldman, 1989; Hadley and Osei, 1982; Kitagawa and Hauser, 1973; Machenback and Looman, 1993; Palmer, 1989; Silver, 1972; Sorlie et al., 1995; Walker et al., 1989; Ware et al., 1986.



A local stability analysis is required to examine the dynamic properties in the neighbourhood of each of the stationary points. The Jacobian is

$$J = \begin{bmatrix} \alpha - \beta y - (\alpha' - \beta' y) \frac{k}{x} & -\beta x & (\alpha' - \beta' y) \\ y \left[ \beta - (\beta' x - \omega') \frac{k}{x^2} \right] & \beta x - \omega & (\beta' x - \omega') \frac{y}{x} \\ sF_x & 0 & sF_k - \phi \end{bmatrix} \quad (58)$$

where  $x$ ,  $y$  and  $k$  are now measured as deviations from a particular stationary point and derivatives in the Jacobian are evaluated at that stationary point.

By expanding (58) around the first stationary point<sup>179</sup> (55) and by using a similarity transformation the Jacobian  $J$  is similar to the matrix  $E$

$$E = \begin{bmatrix} 0 & -\alpha\omega & -\alpha\omega \left( \frac{\beta'}{\beta} - \frac{\omega'}{\omega} \right) \\ 1 & 0 & \alpha \left( \frac{\alpha'}{\alpha} - \frac{\beta'}{\beta} \right) \\ -\frac{k}{x} & 0 & sF_k - \phi - \alpha \frac{k}{x} \left( \frac{\alpha'}{\alpha} - \frac{\beta'}{\beta} \right) \end{bmatrix} \quad (59)$$

It follows that  $J$  and  $E$  have the same eigenvalues (see Appendix A.1). It is possible to show that there is a wide variety of local dynamic patterns, as summarized in Table 2.

Specifically, the study of the characteristic equation of matrix  $J$ ,

$$\varsigma(\eta) = -v(\eta) = \eta^3 - b_{33}\eta^2 + \left( \frac{k}{x}b_{13} + \alpha\omega \right) \eta - \alpha\omega \left( b_{33} + \frac{k}{x}b_{23} \right) = 0 \quad (60)$$

as plotted in Fig. 8 and Fig. 9, indicates that, depending on whether

$$b_{33}^2 - 3\left( \frac{k}{x}b_{13} + \alpha\omega \right) \quad (61)$$

is less/equal or greater than zero, there are either no turning point/one point of inflection or two turning points.

In the former case, as the function (60) is always increasing, there is a single negative real root and a pair of complex conjugate roots leading to a

---

<sup>179</sup>From the Euler equation, as  $F_x = \frac{F}{x} - F_k(\frac{k}{x})$  we have  $sF_x = s\left(\frac{F}{x} - F_k(\frac{k}{x})\right)$ .



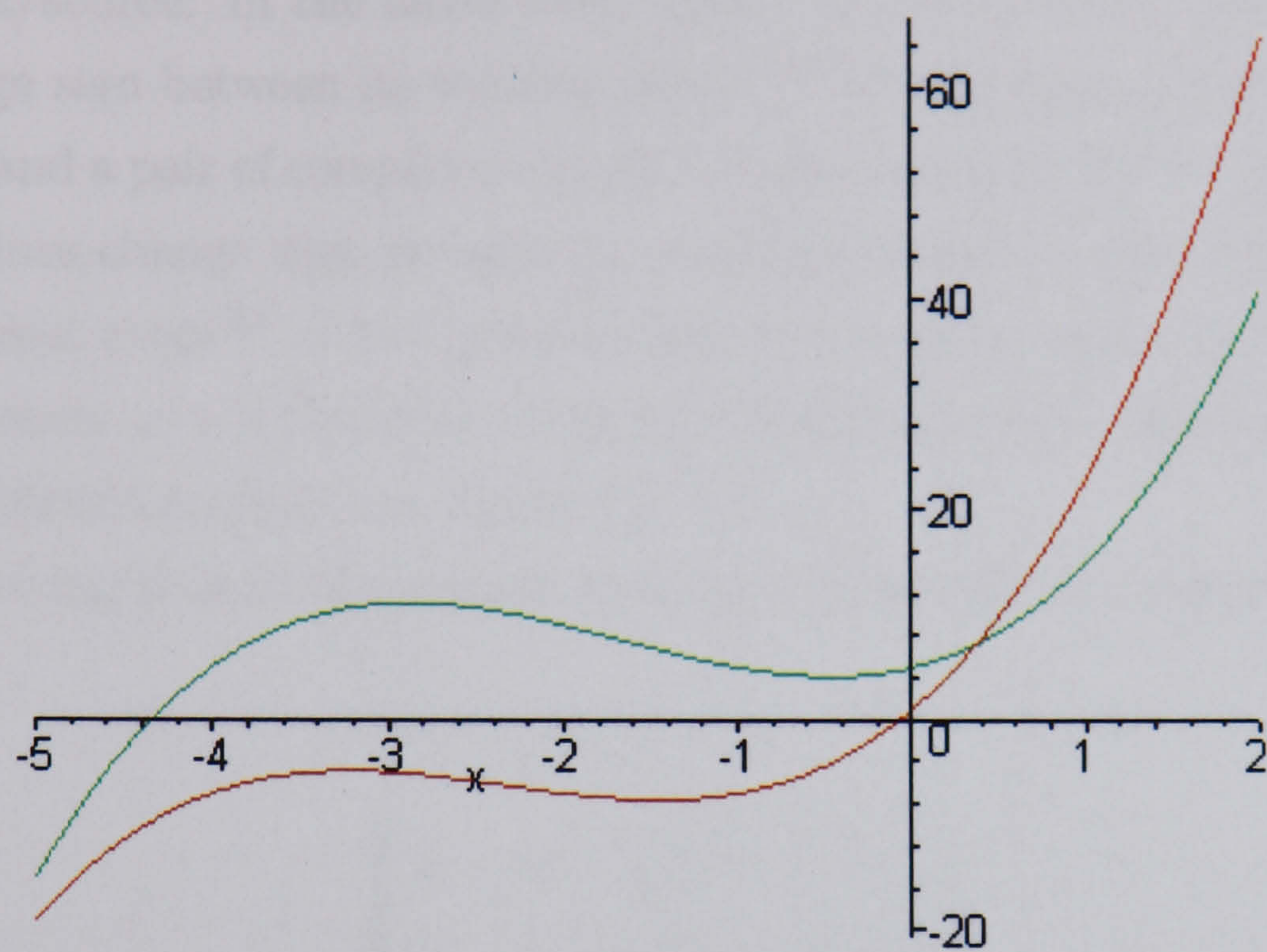

Figure 8: Characteristic equation of matrix  $J$ : case with no turning point/one point of inflection

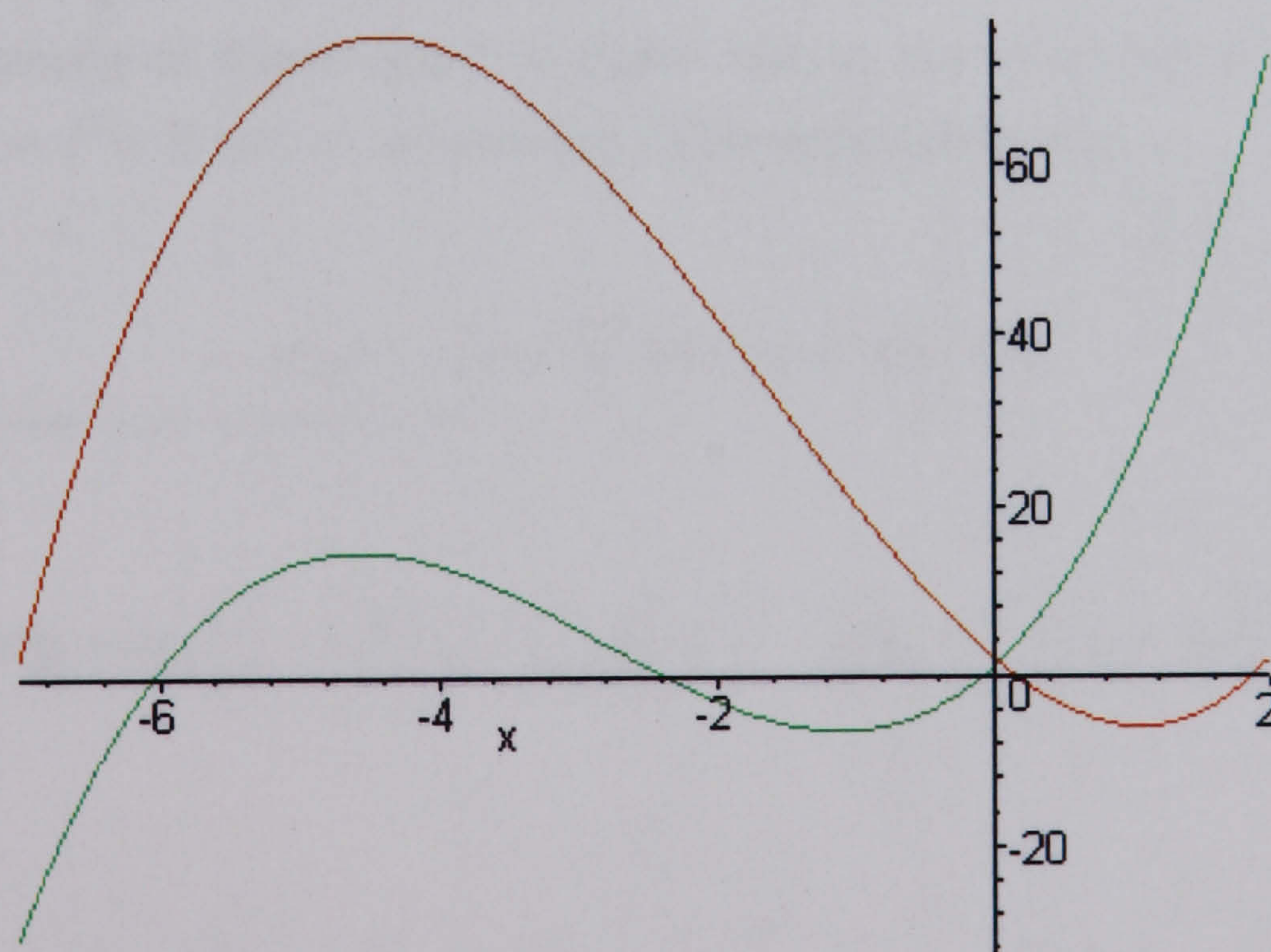

Figure 9: Characteristic equation of matrix  $J$ : case with two turning points



focus sink/source. In the latter case, when the characteristic equation does not change sign between its turning points,<sup>180</sup> we still have a single negative real root and a pair of complex conjugate roots leading to a focus sink/source; when it does change sign between its turning points<sup>181</sup> we have either three negative real roots<sup>182</sup> or two positive and one negative real roots<sup>183</sup> leading to a 3-D node or a 3-D saddle point with stable direction, respectively. For a more detailed analysis see Appendix A.1.

Linearizing around the second stationary point (56) the Jacobian in (58) becomes

$$\begin{bmatrix} 0 & -\omega & \left(\frac{\alpha'}{\alpha} - \frac{\beta'}{\beta}\right) \\ \alpha & 0 & \alpha\left(\frac{\beta'}{\beta} - \frac{\omega'}{\omega}\right) \\ 0 & 0 & sF_k - \phi \end{bmatrix} \quad (62)$$

where, given that each input is essential in that if  $k(t) = 0$  or  $x(t) = 0$ , then  $F(k(t), x(t)) = 0$ ,  $F(k^*, x^*) = 0$  as  $k^* = 0$ . However, as  $x^*, y^*$  are nonzero,  $\frac{F(k(t), x(t))}{x} = 0$  and  $F_k$  has a finite value. As from the assumptions of homogeneity of degree one  $F = F_x x + F_k k$ , at the stationary point  $F_x = 0$  (since  $k^* = F = 0$  but  $x^*$  is nonzero). The eigenvalues are

$$\eta_{1,2} = \pm i\sqrt{\alpha\omega} \text{ and } \eta_3 = sF_k - \phi \quad (63)$$

---

<sup>180</sup>Here

$$\left[ b_{33} \left( -2b_{33}^2 + 9b_{13} \frac{k}{x} \right) - 9 \left( 2b_{33} + 3 \frac{k}{x} b_{23} \right) \alpha\omega \right]^2 - \left( b_{33}^2 - 3 \left( \frac{k}{x} b_{13} + \alpha\omega \right) \right)^3 > 0 \quad (f7)$$

<sup>181</sup>Here

$$\left[ b_{33} \left( -2b_{33}^2 + 9b_{13} \frac{k}{x} \right) - 9 \left( 2b_{33} + 3 \frac{k}{x} b_{23} \right) \alpha\omega \right]^2 - \left( b_{33}^2 - 3 \left( \frac{k}{x} b_{13} + \alpha\omega \right) \right)^3 < 0 \quad (f8)$$

<sup>182</sup>When  $\frac{k}{x} b_{13} + \alpha\omega > 0$ .

<sup>183</sup>When  $\frac{k}{x} b_{13} + \alpha\omega < 0$ .



This stationary point<sup>184</sup> is characterized by the same root as in the pure Lotka-Volterra type system and by a third additional real root  $(sF_k - \phi)$  which has an ambiguous sign. It follows that two dynamic patterns are possible depending as whether  $(sF_k - \phi)$  is greater or less than zero. When  $(sF_k - \phi) < 0$  we have a two dimensional surface in  $(x, y, k)$  space (in the  $xy$  space for  $k = 0$ ) tangent to the complex eigenvector corresponding to the pure imaginary root with paths starting away from this surface spiralling in a stable way towards the manifold (except for a unique path through the "centre" of all such spirals) that converges monotonely to the surface and with paths starting on the surface itself that remain there and form pure cycles on the surface (3-D centre positive attractor). If  $(sF_k - \phi) > 0$ , we have the same pattern but with paths that diverge away from the centre (3-D centre negative attractor).

Linearizing around the third stationary point (57), the Jacobian becomes

$$\begin{bmatrix} \alpha & 0 & \alpha' \\ \omega' & -\omega & -\omega' \\ sF_x & 0 & sF_k - \phi \end{bmatrix} \quad (64)$$

Both  $F_x$  and  $F_k$  are assumed to have finite values and taking  $x(t) \rightarrow 0$ ,  $y(t) \rightarrow 0$  and  $k(t) \rightarrow 0$  along the ray  $x(t) = y(t) = k(t)$ . The eigenvalues are

$$\eta_{1,2} = \frac{1}{2} \left\{ [\alpha + sF_k - \phi] \pm \sqrt{[\alpha - sF_k - \phi]^2 + 4sF_x\alpha'} \right\} \quad (65)$$

and

$$\eta_3 = -\omega \quad (66)$$

It can be shown (see Appendix A2) that for the third stationary states, according to whether

---

<sup>184</sup>If we assume  $\alpha < 0$  we have a 3-D saddle point as in  $\pm i\sqrt{\alpha\omega}$  the eigenvalues are real and distinct and of opposite sign (with stable or unstable direction depending on whether  $(sF_k - \phi)$  is negative or positive, respectively). The case of  $\alpha = 0$  is a degenerate case.



$$[\alpha - sF_k - \phi]^2 + 4sF_x\alpha' - 4sF_k\phi + 4\alpha\phi \quad (67)$$

is less or greater than zero we can have different local dynamic patterns, as summarised in Table 3. Specifically, for (67) being negative we have one single negative real root and a pair of complex conjugate roots which correspond to a focus sink/source (depending on whether  $\alpha + sF_k - \phi$  is less or greater than zero, respectively) or a 3D centre (for  $\alpha + sF_k - \phi = 0$ ). For (67) being positive we can either have three negative real roots (for  $\alpha < \phi$ ) or two negative and one positive real roots (for  $\alpha > \phi$ ) corresponding to a 3-D node (positive attractor) or a 3-D saddle (stable or unstable direction), respectively.

The transition between the different equations cannot be fully understood given the limits of the linear stability analysis in that it focuses on the neighbourhood of the equilibrium points. To learn more about the system we move to calibrated numerical analysis.



Countries	GNP per capita (\$) 1998	Total Population (millions) 1998	Crude Birth Rate 1998	Crude Death Rate 1998	TB Death Rate 1998	TB Prevalence 1997	Net Growth Population Rate	Total Death Rate	TB Prev/Total Pop (per thousands)
AFR	576.543	16.089	3.8579 per cent	1.5132 per cent	2.170 per cent	60.816	2.3259 per cent	3.6832 per cent	3.79
AMR	13,915.295	33.587	2.3391 per cent	0.6565 per cent	0.955 per cent	24,391	1.6826 per cent	1.6115 per cent	0.727
SEAR	679.643	184.950	2.4125 per cent	0.8750 per cent	3.680 per cent	953,375	1.5375 per cent	4.5550 per cent	5.18
EUR	12,945.166	18.182	1.2422 per cent	0.9578 per cent	0.648 per cent	14,044	0.2844 per cent	1.6058 per cent	0.773
EMR	1,674.217	23.620	2.6067 per cent	0.5400 per cent	5.057 per cent	59,333	1.0667 per cent	5.5970 per cent	2.52
WPR	3,759.292	125.754	2.1462 per cent	0.7615 per cent	2.923 per cent	288,615	1.3847 per cent	3.6845 per cent	2.30

Table 1 Source World Bank, 2000; World Health Organization, 2000b, d.



$b_{33}^2 - 3\frac{k}{x}b_{13} - 3\alpha\omega$	$\leq 0$	$> 0$	$> 0$	$> 0$
$[b_{33}(-2b_{33}^2 + 9b_{13}\frac{k}{x}) - 9(2b_{33} + 3\frac{k}{x}b_{23})\alpha\omega]^2 - (b_{33}^2 - 3(\frac{k}{x}b_{13} + \alpha\omega))^3$		$> 0$	$< 0$	$< 0$
$\frac{k}{x}b_{13} + \alpha\omega$			$> 0$	$< 0$
	focus sink/source	focus sink/source	3-D node	3-D saddle

Table 2 Local dynamic patterns around the first stationary point, economic-epidemiological model



$[\alpha - sF_k - \phi]^2 + 4sF_x\alpha' - 4sF_k\phi + 4\alpha\phi$	$< 0$	$< 0$	$< 0$	$< 0$	$> 0$	$> 0$
$\alpha - sF_k - \phi$	$= 0$	$> 0$	$< 0$			
$\alpha - \phi$					$> 0$	$< 0$
	3-D centre	focus source	focus sink	3-D saddle	3-D node	

Table 3 Local dynamic patterns around the third stationary point, economic-epidemiological model



### 3.2.1 Calibration

In what follows by the use of calibration we simulate the quantitative nature of the dynamics for each of these two cases. Since for the population dynamics there are quite strong arguments to select functional forms that give a bounded effect to economic prosperity on net population growth or the spread of disease, we select a logistic type function where

$$\begin{aligned}\alpha(z(t)) &= \alpha_0 - \alpha_1 \exp^{-\alpha_2 z(t)} \\ \beta(z(t)) &= \beta_0 + \beta_1 \exp^{-\beta_2 z(t)} \\ \omega(z(t)) &= \omega_0 + \omega_1 \exp^{-\omega_2 z(t)}\end{aligned}\tag{68}$$

(recall that  $z(t)$  is  $k(t)/x(t)$ ). With zero capital, the baseline net growth of the healthy is  $\alpha_0 - \alpha_1$ ; the baseline infection rate is  $\beta_0 + \beta_1$  and the baseline death rate of the infected is  $\omega_0 + \omega_1$ . As the capital labour ratio,  $z$ , tends to infinity the net growth rate of the healthy is  $\alpha_0$ ; the infection rate  $\beta_0$  and the death rate of the infected  $\omega_0$ . Consequently if  $\alpha_1$  is negative, the birth rate falls with the capital labour ratio; conversely, if  $\alpha_1$  is positive. The speed with which the upper bounds are reached is determined by the coefficients with subscript 2.

As a production function we take a CES with elasticity of substitution less than unity:

$$F(k(t), x(t)) = (rk(t)^m + vx(t)^m)^{\frac{1}{m}}\tag{69}$$

where  $m < 0$  and  $r, v > 0$ .

With these choices we have

$$F_x = v \left[ r \left( \frac{k(t)}{x(t)} \right)^m + v \right]^{\frac{(1-m)}{m}}\tag{70}$$

$$\frac{F}{x} = \left[ r \left( \frac{k(t)}{x(t)} \right)^m + v \right]^{\frac{1}{m}}\tag{71}$$



$$F_k = r \left[ r + v \left( \frac{x(t)}{k(t)} \right)^m \right]^{\frac{(1-m)}{m}} \quad (72)$$

The three stationary states are, respectively, at

$$\left( x_1^* = \frac{\omega}{\beta}; y_1^* = \frac{\alpha}{\beta}; \left( \frac{k}{x} \right)_1^* = \left[ \left( \frac{\phi}{s} \right)^m / v - r/v \right]^{\frac{1}{m}} \right) \quad (73)$$

$$\left( x_2^* = \frac{\omega}{\beta}; y_2^* = \frac{\alpha}{\beta}; k_2^* = 0 \right) \quad (74)$$

$$(x_3^* = y_3^* = k_3^* = 0) \quad (75)$$

As in Section 3.1.1, for the case in which the net birth rate increases with prosperity, we use data from the Region of Americas (AMR) and the South-East Asia Region (SEAR) as representatives of high capital and low capital countries, respectively. Given that the depreciation rate of capital,  $\phi$ , represents a weighted average of the depreciation rate of the different types of assets in the capital stock (i.e. buildings, machineries, vehicles), we set  $\phi = 0.15$ . The parameter values then are:<sup>185</sup>  $r = 0.3$ ,  $v = 0.7$ ,  $s = 0.1$ ,  $m = -1$ ,  $\phi = 0.15$ ,  $\alpha_0 = 0.017$ ,  $\alpha_1 = 0.002$ ,  $\alpha_2 = 1$ ,  $\beta_0 = 0.028$ ,  $\beta_1 = 0.26$ ,  $\beta_2 = 1$ ,  $\omega_0 = 0.016$ ,  $\omega_1 = 0.03$ ,  $\omega_2 = 1$ . With these parameter values, as  $z$  varies from 0 to  $\infty$ , the net population growth rate of the healthy people varies from 1.5 per cent to 1.7 per cent, the TB transmission coefficient from 28.8 per cent to 2.8 per cent and the total death rate of the infected individual from 4.6 per cent to 1.6 per cent.

With these parameter values<sup>186</sup> the three stationary states are

---

<sup>185</sup>Here we assume the share of wages in GNP ( $v$ ) to be about 70 per cent, the share of capital ( $r$ ) about 30 per cent, the savings rate ( $s$ ) of 10 per cent and the elasticity of substitution greater than one ( $= 2$ ). Blanchard and Fischer, 1989.

<sup>186</sup>See Note 160.



$$(x_1^* = 0.186, y_1^* = 0.087, k_1^* = 0.097) \quad (76)$$

$$(x_2^* = 0.160, y_2^* = 0.052, k_2^* = 0) \quad (77)$$

$$(x_3^* = 0, y_3^* = 0, k_3^* = 0) \quad (78)$$

The eigenvalues corresponding to a linear approximation around the first stationary state (76) are

$$[-0.0007 + 0.022i, \quad -0.0007 - 0.022i, \quad -0.089] \quad (79)$$

which correspond to the case of two complex conjugate roots and one negative real root leading to focus sink. Different parameter values would have generated the other combinations of eigenvalues near this stationary state. Around the second stationary state (77) the eigenvalues are

$$[0.165i, \quad -0.165i, \quad -0.15] \quad (80)$$

which reflects the analytical results above leading to a 3-D centre (positive attractor). When  $k^* = 0$  the stationary state TB prevalence is  $(\frac{y}{x})^* = 0.326$  whereas when  $k^* \neq 0$  the TB prevalence is increased to 0.468. However, in the economic-epidemiological model the total population increases from 0.212 when  $k^* = 0$ , to 0.272 when  $k^* \neq 0$ .

As the derivatives of the production function are not uniquely defined as  $x(t) \rightarrow 0$  and  $k(t) \rightarrow 0$ , we do not attempt to linearise around the third stationary point (78).

We can then patch together the local dynamics around each stationary state to explore the way these form a global phase space. To do so we integrate the non-linear differential equations and not their linear approximations. The phase spaces are globally accurate within the limits of MAPLE.



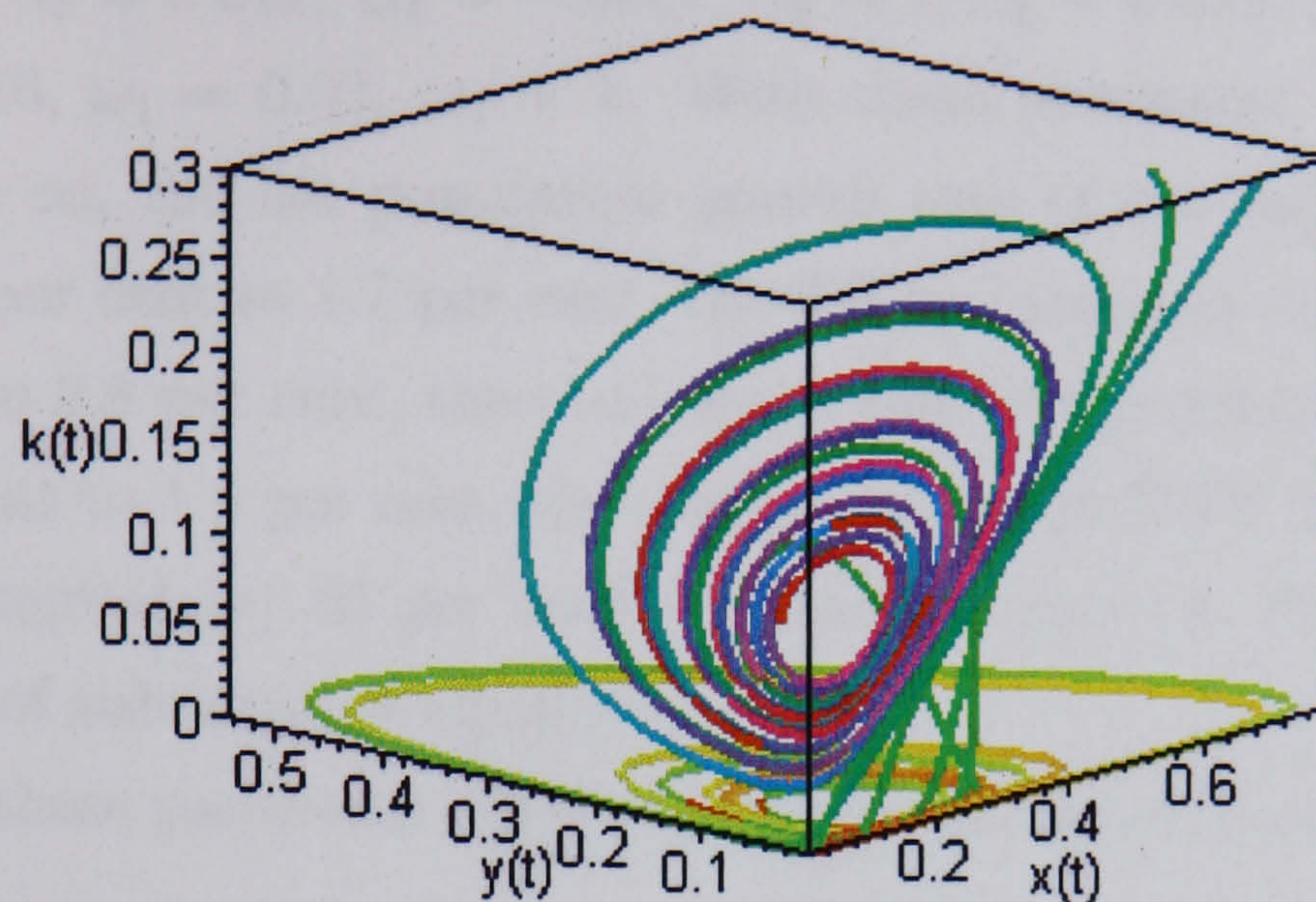

Figure 10: Global phase-space diagram, economic-epidemiological model with the three stationary states, calibration results,  $\alpha' > 0$

The global dynamics, shown in Fig. 10, reveals that paths which start with low capital per healthy worker have a phase in which the system has epidemic cycles in population analogous to the dynamics of the predator-prey Lotka-Volterra type system. On these demographic-epidemiological cycles when the population falls sufficiently close to zero, the capital per healthy worker is high enough to improve the demographic-epidemiological parameters and allow capital accumulation from output. The system then moves into a phase in which a rapid economic growth occurs. However, following this, there are both economic and population cycles of a damped form until the new economic-epidemiological stationary point is reached. This analysis provides an explanation for endogenous population cycles in low capital level economies, rapid transition from a low level to a developed status, and in developed economies stable economic-epidemiological cycles.

In what follows we analyse also the case in which the net birth rate decreases with prosperity. In order to do so we use data from the Region



of Americas and the African Region:  $r = 0.3$ ,  $v = 0.7$ ,  $s = 0.1$ ,  $m = -1$ ,  $\phi = 0.15$ ,  $\alpha_0 = 0.017$ ,  $\alpha_1 = -0.007$ ,  $\alpha_2 = 1$ ,  $\beta_0 = 0.028$ ,  $\beta_1 = 0.26$ ,  $\beta_2 = 1$ ,  $\omega_0 = 0.016$ ,  $\omega_1 = 0.03$ ,  $\omega_2 = 1$ . With these parameter values, as  $z$  varies from 0 to  $\infty$ , the net population growth rate of the healthy people varies from 2.4 per cent to 1.7 per cent, the TB transmission coefficient from 28.8 per cent to 2.8 per cent, the total death rate of the infected individual from 4.6 per cent to 1.6 per cent, the share of wages in GNP ( $v$ ) 70 per cent, the share of capital ( $r$ ) 30 per cent, the savings rate ( $s$ ) 10 per cent and the elasticity of substitution equal to 2.

With these parameter values the three stationary states become:

$$(x_1^* = 0.153, y_1^* = 0.116, k_1^* = 0.080) \quad (81)$$

$$(x_2^* = 0.125, y_2^* = 0.083, k_2^* = 0) \quad (82)$$

$$(x_3^* = 0, y_3^* = 0, k_3^* = 0) \quad (83)$$

The eigenvalues of the linearisation around the first stationary state (81) are:

$$[-0.0009 + 0.024i, \quad -0.0009 - 0.024i, \quad -0.088] \quad (84)$$

which correspond to the case of a pair of complex conjugates and one negative real root. Around the second stationary state (82) the eigenvalues are:

$$[0.165i, \quad -0.165i, \quad -0.15] \quad (85)$$

which reflects the analytical results above. Again as the derivatives of the production function are not uniquely defined as  $x(t) \rightarrow 0$  and  $k(t) \rightarrow 0$ ,



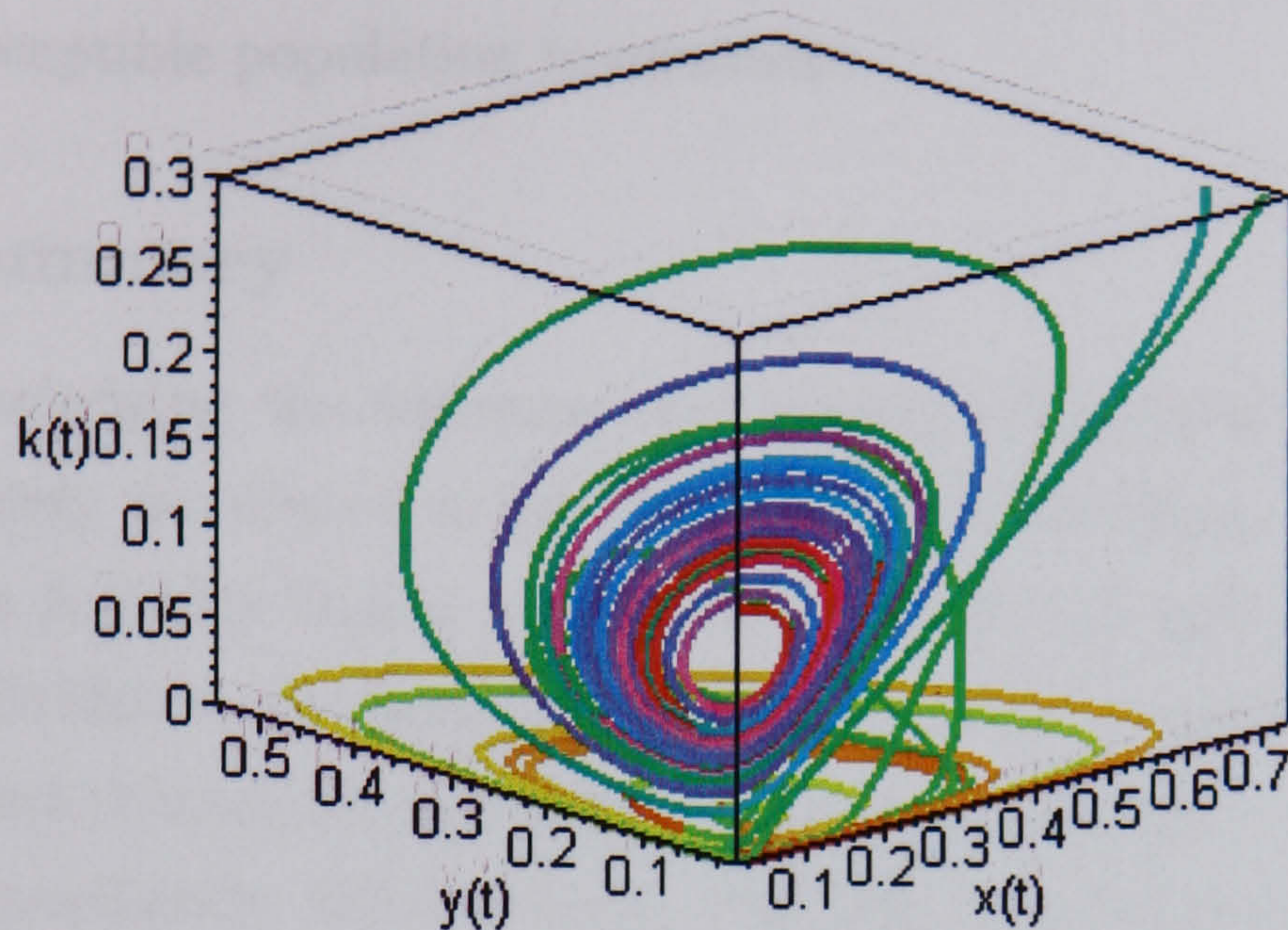

Figure 11: Global phase-space diagram, economic-epidemiological model with three stationary points,  $\alpha' < 0$ , calibration results

we do not attempt to linearise around the third stationary point (83). The stationary state prevalence of the disease rises from 0.667 to 0.759 under the influence of economic growth. Total population increases from 0.208 to 0.269. This results are mainly driven by economic parameters such as the savings rate, the depreciation rate and the elasticity of substitution.

The global phase space with the three stationary states, obtained by numerically integrating the non-linear differential equations is shown in Fig. 11. The interpretation of the dynamics is similar to the case in which the net birth rate of the susceptible population rises with prosperity. The main difference between the two cases is that the prevalence of the TB infectious disease in the first stationary state is lower for  $\alpha' > 0$  (0.468 with  $\alpha' > 0$  and 0.759 with  $\alpha' < 0$ ).

Note that if  $\beta = 0$  then the model reduces to a single sector Solow-Swan model with endogenous healthy population growth where initially TB infected people just die away (e.g. segregation). Moreover, if also  $\alpha_1 = 0$  or



$\alpha_2 = 0$ , then we have a standard Solow-Swan model where the growth rate of the susceptible population is constant.

### 3.3 Summary

By acknowledging the existence of a density dependence effect, so that in more densely populated areas the number of meetings between people is higher, we find that with a population composed of only susceptible and infected individuals, the demographic-epidemiological system is characterised by the same dynamical properties as the predator-prey Lotka-Volterra type model. Specifically, there are two stationary states: the first corresponds to the extinction of the population and the second has a positive number of both susceptible and TB infected individuals. Local stability properties change as the parameter values change. The calibration results, using data from the African Region and the Region of Americas indicate that for any initial number of susceptible and TB actively infected individuals, as  $t$  tends to infinity, the number of susceptible and actively infected classes exhibits periodic behaviour around the stationary state with a positive number of both susceptible and infected people. As the system has an equilibrium point which is a centre, the system never reaches the stationary state. This case excludes the possibility for an infectious disease to be eradicated. In the extreme case in which there are no individuals in the susceptible class, as  $t$  tends to infinity, the TB actively infected fraction just dies out; the system converges to the equilibrium point which coincides with the origin, causing the extinction of the population community to occur. Furthermore, the system presents a partially balanced growth path where there is no disease. For any initial conditions on this path the disease cannot break out. For initial conditions starting away from this path, the system cannot eradicate the disease.

By considering the two way interaction between the demographic-epidemiological factors and the economy, the presence of the economy allows the system to settle down at a stationary state after some initial



cyclical dynamics, thus avoiding perpetual epidemic cycles. The presence of the disease eliminates the possibility of steady growth. At the new economic-epidemiological equilibrium point TB prevalence is higher in presence of capital accumulation than without. However, as we move from the pure demographic-epidemiological equilibrium point to the economic-epidemiological steady state with economic growth, also the total population increases. Calibration results using data from the Region of Americas, African Region and South-East Asian Region confirm our analytical outcomes.<sup>187</sup> The evidence supports the existence of population cycles in both capital rich and capital poor countries. However, in the former, there is also a business cycle in capital per healthy worker although this is damped as it converges to the long run equilibrium point. We have also found that the system which starts with zero capital per healthy worker cannot escape from pure predator-prey Lotka-Volterra demographic-epidemiological cycles.

In the next Chapter, we relax the assumption that density dependence has relevant effects and we explore the equilibrium points and dynamics both of the demographic-epidemiological model and the economic-epidemiological framework where economic prosperity is expressed in terms of productive capital per healthy worker. Furthermore, we analyse the case of a central planner who determines savings so that social welfare, function of accumulation of productive capital and level of TB prevalence, is maximised.

---

<sup>187</sup>The results that we get here depend on the demographic-epidemiological structure assumed.



## 4 Descriptive and Optimal Control Analysis of a Productive Capital Model

Historically, although the eradication of infectious diseases sometimes followed improvements in medical knowledge, technology and educational programmes<sup>188</sup> (e.g. clean water for control of cholera in India or TB in Honduras) or specific targeted regulatory policies (e.g. segregation for control of plague and leprosy in Europe - Italy), economic growth has constituted one of the main instruments for controlling the spread of diseases.

In this Chapter we argue that broad social-economic policy is relevant in controlling TB as it addresses the fundamental causes of the disease: poverty, malnourishment, overcrowded and insanitary living and working conditions.

In the previous chapter we used a particular form of density dependence in the TB transmission process. We should consider alternative forms of density dependence as well as the possibility of no density dependence effects. Moreover, the specification of Chapter 3 leads to an inhomogeneous system. In this chapter, as we do not use a density dependent process, we work with a homogenous system. In contrast with the framework developed in Chapter 3, in what follows the interpersonal contact rate is taken as not to include a density dependent effect. Recall from Section 2.2.4 that the probability that a susceptible person becomes infected is given by the product of the probability of meeting a TB infected person and the probability that the meeting leads to the infection. Here, with  $\beta$  representing the probability of infection from an encounter between a TB infected and a susceptible individual and with equally likely meetings between any two people, the probability of meeting an infected person<sup>189</sup> is considered to be the proportion of the TB infected people in the total population,  $y(t)/N(t)$  with  $N(t) = x(t) + y(t)$ .

The chapter is organized as follows. Section 4.1 introduces the

---

<sup>188</sup>Mata, 1985; Watts, 1997.

<sup>189</sup>This approach has been used by May and Anderson (1989) in exploring the dynamics of HIV and AIDS. The same interaction process "formula" is obtained when a population of total fixed size is analysed.



demographic-epidemiological model used and explores their equilibrium points and dynamics. Section 4.2 contains a dynamic analysis of the general economic prosperity model where economic prosperity is measured by the ratio of productive capital to the number of healthy workers. Section 4.3 illustrates the case of a centrally planned economy in which savings is chosen to balance the welfare effects of current and future consumption and the effects of capital accumulation on controlling TB.

Each section presents analytic results and a calibrated version of the model using realistic data for the demographic, epidemiological and economic parameters.

#### 4.1 Descriptive Analysis: Demographic - Epidemiological Model

The dynamics of a population of healthy ( $x(t)$ ) and TB infected individuals ( $y(t)$ ) at any instant  $t$  ( $t \geq 0$ ) obeys

$$\begin{cases} \dot{x}(t) = \alpha x(t) - \frac{\beta x(t) y(t)}{x(t)+y(t)} \\ \dot{y}(t) = \frac{\beta x(t) y(t)}{x(t)+y(t)} - \omega y(t) \end{cases} \quad (86)$$

According to this approach,  $\beta$  is a combination of the probability of infection spreading given a meeting between an infected person and a susceptible and the probability of a person meeting someone else. Here,  $\alpha$  and  $\omega$  represent the net growth population rate of the susceptible people and the total death rate of the TB infected individuals, respectively.

By considering  $p(t) = \frac{y(t)}{x(t)}$  as the TB infected/susceptible individuals ratio



or the level of TB prevalence, the system in (86) can be rewritten as<sup>190</sup>

$$\begin{cases} \dot{p}(t) = \frac{\beta p(t)}{1+p(t)} - \omega p(t) - p(t)\left(\alpha - \frac{\beta p(t)}{1+p(t)}\right) = (\beta - \alpha - \omega)p(t) \\ \frac{\dot{x}(t)}{x(t)} = \alpha - \beta \frac{p(t)}{1+p(t)} \end{cases} \quad (87)$$

---

<sup>190</sup>From (86) we know

$$\frac{\dot{x}(t)}{x(t)} = \alpha - \frac{\beta \frac{y(t)}{x(t)}}{1 + \frac{y(t)}{x(t)}} \quad (f9)$$

By setting  $p(t) = \frac{y(t)}{x(t)}$ , we can re-write (f9) as

$$\frac{\dot{x}(t)}{x(t)} = \alpha - \frac{\beta p(t)}{1+p(t)} \quad (f10)$$

Furthermore, as

$$\frac{\delta \left( \frac{y(t)}{x(t)} \right)}{\delta t} = \frac{\dot{y}(t)}{x(t)} - y(t) \frac{\dot{x}(t)}{x^2(t)} \quad (f11)$$

from (86) we know that

$$\frac{\delta \left( \frac{y(t)}{x(t)} \right)}{\delta t} = \frac{\beta \frac{x(t)}{x(t)} \frac{y(t)}{x(t)}}{\frac{x(t)+y(t)}{x(t)}} - \omega \frac{y(t)}{x(t)} - \frac{y(t)}{x(t)} \left( \alpha - \frac{\beta p(t)}{1+p(t)} \right) \quad (f12)$$

or recalling that  $p(t) = \frac{y(t)}{x(t)}$

$$\dot{p}(t) = \frac{\beta p(t)}{1+p(t)} - \omega p(t) - p(t) \left( \alpha - \beta \frac{p(t)}{1+p(t)} \right) \quad (f13)$$

or

$$\dot{p}(t) = \frac{\beta p(t) - \omega p(t) - \omega p^2(t) - \alpha p(t) - \alpha p^2(t) + \beta p^2(t)}{1+p(t)} \quad (f14)$$

$$\dot{p}(t) = \frac{p(t) [(\beta - \alpha - \omega) + p(t) (\beta - \alpha - \omega)]}{1+p(t)} \quad (f15)$$

$$\dot{p}(t) = \frac{p(t) [(\beta - \alpha - \omega) (1 + p(t))]}{1+p(t)} = (\beta - \alpha - \omega) p(t) \quad (f16)$$



where  $\alpha$  (the net growth rate of the healthy individuals),  $\beta$  (the TB transmission coefficient) and  $\omega$  (the overall mortality rate of the infected people) are positive constants.

The stability of the system is analysed by solving the equations  $\dot{p}(t) = 0$  and  $\frac{\dot{x}(t)}{x(t)} = 0$ . It can be shown<sup>191</sup> that the system (87) has no stationary points or steady states. The  $\dot{p}(t)$  equation has one solution given by

$$p(t) = p_0 e^{(\beta - \alpha - \omega)t} \quad (88)$$

that, once substituted back into  $\frac{\dot{x}(t)}{x(t)} = 0$  gives

$$\frac{\dot{x}(t)}{x(t)} = \alpha - \beta \frac{p_0 e^{(\beta - \alpha - \omega)t}}{1 + p_0 e^{(\beta - \alpha - \omega)t}} \quad (89)$$

It follows that the dynamics of the number of susceptible and infected individuals is given by<sup>192</sup>

---

<sup>191</sup>By looking at the system in (87),  $\dot{p} = 0$  requires  $p = 0$ . However, for  $p = 0$ ,  $x(t)$  grows at rate  $\alpha$  whilst  $y = 0$ .

<sup>192</sup>From (89) separating the variables

$$d \log x = \frac{\alpha + \beta e^{(\beta - \alpha - \omega)t}}{1 + \beta e^{(\beta - \alpha - \omega)t}} dt \quad (f17)$$

By integrating both sides we have

$$\int d \log x = \int \frac{\alpha + \beta e^{(\beta - \alpha - \omega)t}}{1 + \beta e^{(\beta - \alpha - \omega)t}} dt \quad (f18)$$

from which

$$\log x = \alpha t + \int \frac{\beta e^{(\beta - \alpha - \omega)t}}{1 + \beta e^{(\beta - \alpha - \omega)t}} dt \quad (f19)$$

or

$$\log x = \alpha t + \log \frac{1 + \beta e^{(\beta - \alpha - \omega)t}}{(\beta - \alpha - \omega)} + \text{const.} \quad (f20)$$



$$x(t) = x_0 e^{\alpha t} [1 + p_0 e^{(\beta - \alpha - \omega)t}]^{-\frac{\beta}{(\beta - \alpha - \omega)p_0}} \quad (90)$$

and

$$y(t) = p_0 x_0 e^{(\beta - \omega)t} [1 + p_0 e^{(\beta - \alpha - \omega)t}]^{-\frac{\beta}{(\beta - \alpha - \omega)p_0}} \quad (91)$$

From (88) it is clear that when the infection rate is greater than the sum of the net growth rate of the susceptible and the death rate of the infected people ( $\beta - \alpha - \omega > 0$ ), as  $t \rightarrow \infty$ , the infected/healthy people ratio rises exponentially (Fig. 12a). For  $\beta - \alpha - \omega < 0$ ,  $p$  approaches zero so that the disease eventually is eradicated (here  $x(t) \rightarrow 0$  as  $t \rightarrow \infty$ ) (Fig. 12b). Another important qualitative information can be inferred by observing in (89) that, if the net growth rate of the susceptible is smaller than  $\beta \frac{p_0}{1+p_0}$ , the number of healthy individuals has a non-monotonic behaviour. Specifically, although for sufficiently small  $t$ , for  $\alpha > \beta \frac{p_0}{1+p_0}$ , the change in the number of healthy per healthy person ( $\frac{\dot{x}(t)}{x(t)}$ ) is monotonically increasing, for  $\alpha < \beta \frac{p_0}{1+p_0}$ ,  $\frac{\dot{x}(t)}{x(t)}$  starts negative and then becomes positive as  $t \rightarrow \infty$ . These results suggest that, depending on whether  $(\beta - \alpha - \omega)$  is greater or less than zero, the disease can either spread into a specific area following an explosive pattern and eventually leading to a pandemic situation or leave untouched other regions.

#### 4.1.1 Calibration

In this Section the parameter values are numerically calibrated so that the initial model equilibrium replicates a given observed benchmark data set. For the case where  $(\beta - \alpha - \omega > 0)$  reflects the case of the East Mediterranean Region:  $\alpha = 0.017$ ,  $\beta = 0.197$ ,  $\omega = 0.056$ . With these parameters the net population growth rate of the susceptible population is 1.7 per cent, the TB transmission coefficient 19.7 per cent and the total death rate of the infected individuals 5.6 per cent. The case where  $(\beta - \alpha - \omega < 0)$ , data have been taken from the Western Pacific Region:  $\alpha = 0.014$ ,  $\beta = 0.012$ ,



$\omega = 0.015$ . With these parameters the net population growth rate of the susceptible population is 1.4 per cent, the TB transmission coefficient 2.2 per cent and the total death rate of the infected individuals 2.0 per cent. As shown in the phase diagram of Fig. 13, the total population grows exponentially so that eventually the healthy are eliminated or, as in Fig. 14, fall so low so that the TB infected are eliminated depending on whether the TB transmission coefficient is less or greater than the combined net growth rate of the susceptible class and the total death rate of the infected individuals, respectively.

These results find evidence in the evidence of certain countries/regions<sup>124</sup> (i.e. Europe, United States) where improved living standards and the availability of effectively used antibiotics have reduced the risk of transmission of TB, here represented by  $\beta$  (Fig. 14). However, within these countries/regions there are pockets of poverty (i.e. migrants communities)<sup>125</sup> or specific institutions (i.e. prisons)<sup>126</sup> where the overcrowded and poor living conditions, lack of access to preventive therapy together with an already compromised health status have enhanced the probability of TB transmission and favour the rapid spread of the disease (Fig. 13).

### 4.3 Descriptive Analysis: Economic-Epidemiological Model

Rising economic prosperity has had a profound impact on the diet, living and working conditions and health infrastructures and services. Only healthy individuals are assumed to be able to produce output that can be consumed and invested in productive capital. Moreover, once TB infected, an individual is

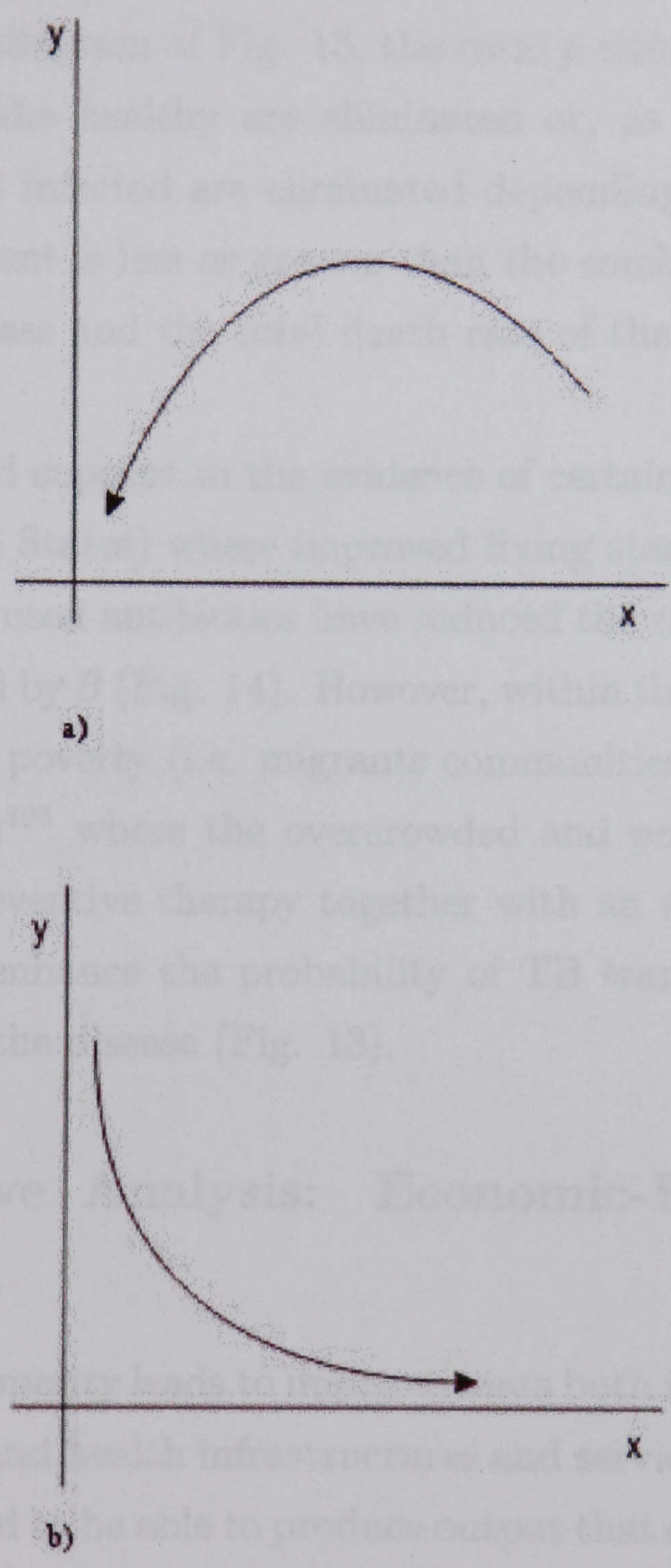

Figure 12: Demographic-epidemiological model: a)  $\beta - \alpha - \omega > 0$ , total population extinction b)  $\beta - \alpha - \omega < 0$ , TB eradication

<sup>124</sup>Quadracci et al., 1984; Howard and Cohen, 2000; Kozicki, 1994; Paros and Brown, 1996; Bawa, 1999.  
<sup>125</sup>Lambertini, 1999; Galvani et al., 1999.  
<sup>126</sup>Wong et al., 1993.



$\omega = 0.026$ . With these parameters the net population growth rate of the susceptible population is 1.4 per cent, the TB transmission coefficient 1.2 per cent and the total death rate of the infected individuals 2.6 per cent. As shown in the phase diagram of Fig. 13, the ratio  $p$  either rises exponentially so that eventually the healthy are eliminated or, as in Fig. 14, falls to zero so that the TB infected are eliminated depending on whether the TB transmission coefficient is less or greater than the combined net growth rate of the susceptible class and the total death rate of the infected individuals, respectively.

These results find support in the evidence of certain countries/regions<sup>193</sup> (i.e. Europe, United States) where improved living standards and the availability of effectively used antibiotics have reduced the risk of transmission of TB, here represented by  $\beta$  (Fig. 14). However, within these countries/regions there are pockets of poverty (i.e. migrants communities)<sup>194</sup> or specific institutions (i.e. prison)<sup>195</sup> where the overcrowded and poor living conditions, lack of access to preventive therapy together with an already compromised health status have enhance the probability of TB transmission and favour the rapid spread of the disease (Fig. 13).

## 4.2 Descriptive Analysis: Economic-Epidemiological Model

Rising economic prosperity leads to improvements both in the diet, living and working conditions and health infrastructures and services. Only healthy individuals are assumed to be able to produce output that can be consumed and invested in productive capital. Moreover, once TB infected, an individual is assumed here to be incapable of work. Here the demographic-epidemiological parameters ( $\alpha$ ,  $\beta$  and  $\omega$ ) are no longer constants and, as in Section 3.2, are

---

<sup>193</sup>Fatkenheurer et al., 1999; Hayward and Coker; 2000; Kochi, 1994; Porco and Blower, 1998; Rieder, 1989.

<sup>194</sup>Landesman, 1992; Scolari et al., 1999.

<sup>195</sup>Belling et al., 1993.



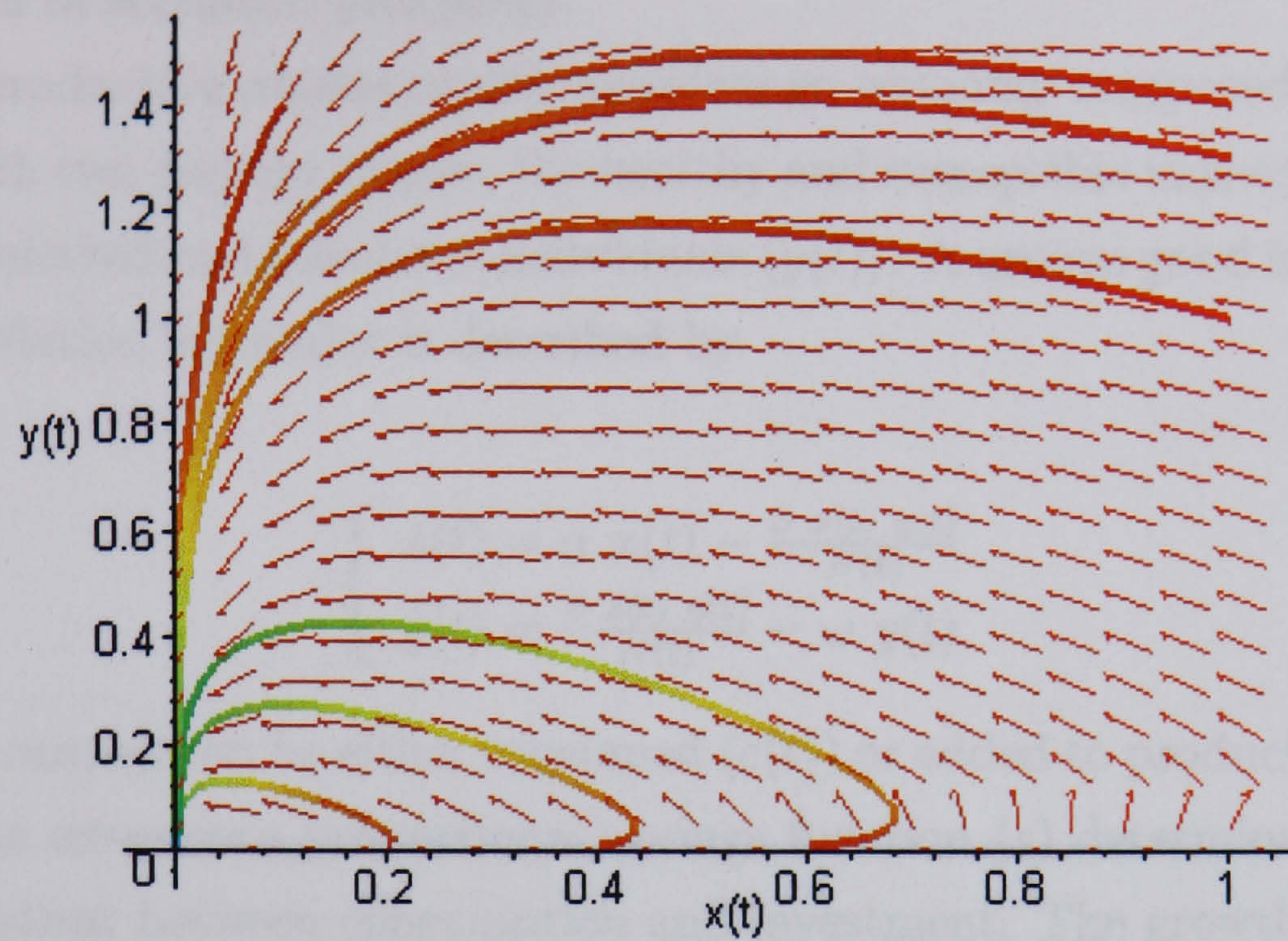

Figure 13: Global phase-plane diagram, demographic-epidemiological model,  $\beta - \alpha - \omega > 0$ , total population extinction

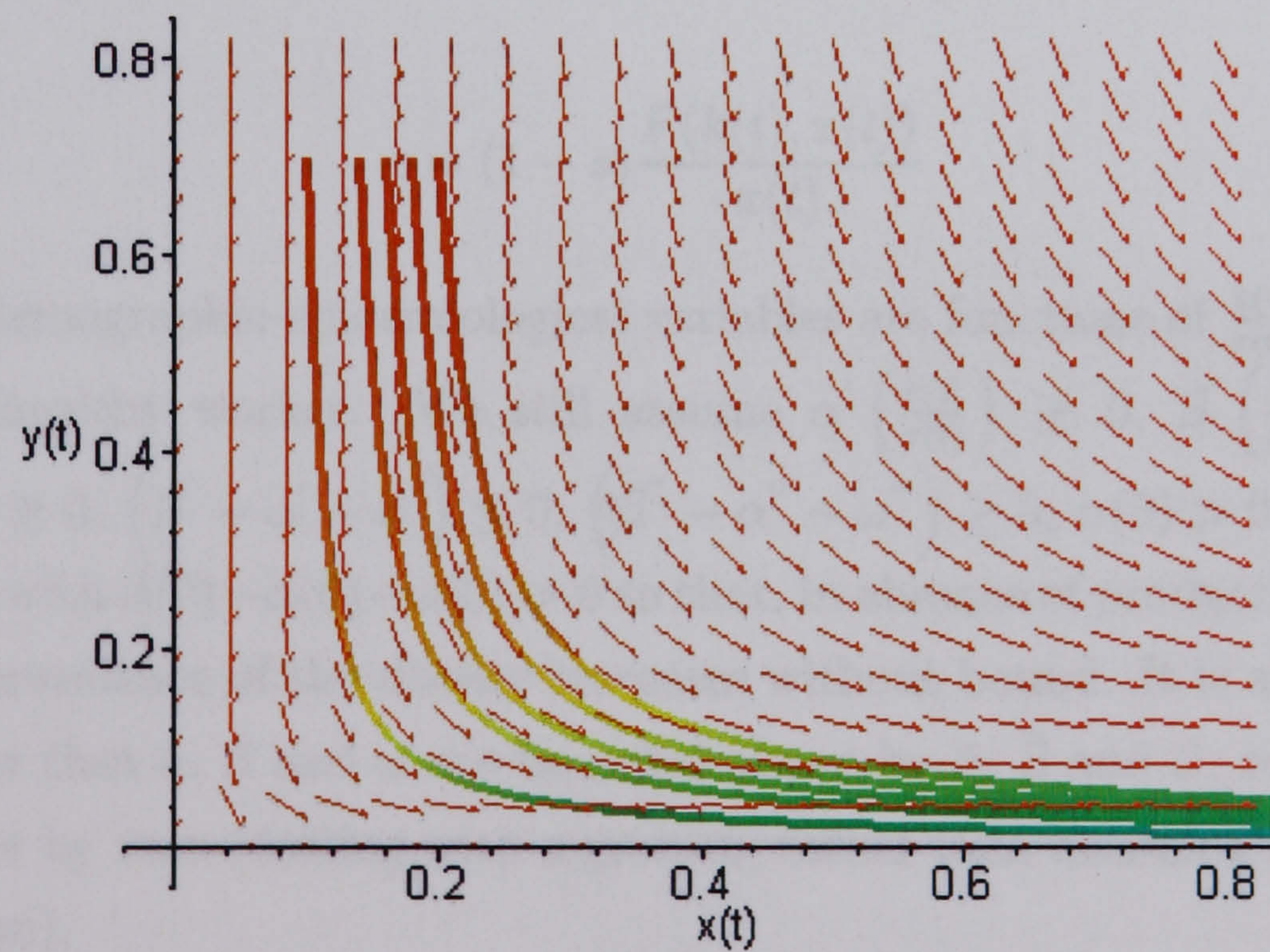

Figure 14: Global phase-plane diagram, demographic-epidemiological model,  $\beta - \alpha - \omega < 0$ , TB eradication



a function of economic prosperity.

The productive capital model considers an economy composed of a population with two disjoint classes, the healthy and susceptible individuals ( $x(t)$ ) and the infected and infectious individuals ( $y(t)$ ). A unique good is produced. The population dynamics is described by

$$\begin{cases} \dot{x}(t) = \alpha x(t) - \frac{\beta x(t) y(t)}{N(t)} \\ \dot{y}(t) = \frac{\beta x(t) y(t)}{N(t)} - \omega y(t) \end{cases} \quad (92)$$

Total output can be either consumed ( $c(t)$ ) or added to productive capital ( $k(t)$ ). An exogenous proportional savings function ( $s$ ) determines the division of output between consumption and investment. The growth of capital stock is given by

$$\dot{k}(t) = sF(k(t), x(t)) - \phi k(t) \quad (93)$$

and per capita consumption of the susceptible people is

$$c = (1 - s) \frac{F(k(t), x(t))}{x(t)}$$

The demographic-epidemiological variables are functions of  $\frac{k(t)}{x(t)}$ , the capital per healthy worker. We still assume  $\alpha' \left( \frac{k(t)}{x(t)} \right) \geq 0$ ,  $\beta' \left( \frac{k(t)}{x(t)} \right) \leq 0$ ,  $\omega' \left( \frac{k(t)}{x(t)} \right) \geq 0$ ,  $(\beta' - \alpha' - \omega') \leq 0$ ,  $(\beta'' - \alpha'' - \omega'') \geq 0$ ,  $\alpha(0) > 0$ ,  $\beta(0) > 0$ ,  $\omega(0) > 0$  with  $\beta(0) - \alpha(0) - \omega(0) > 0$  so that, in absence of productive capital, the TB prevalence of the disease increases without bound. It is also natural to assume that  $\alpha$ ,  $\beta$  and  $\omega$  are bounded above by  $\bar{\alpha}$ ,  $\bar{\beta}$  and  $\bar{\omega}$ , respectively, and below by zero (dealing with a growing rather than declining susceptible population).

The two-way interactions between demographic-epidemiological factors and economic variables in the transmission dynamic of TB in a population of susceptible,  $x(t)$ , and TB actively infected individuals,  $y(t)$ , are described by an autonomous system in  $\mathfrak{R}^3$  of three non-linear differential equations



$$\begin{cases} \dot{x}(t) = \alpha x(t) - \frac{\beta x(t)y(t)}{x(t)+y(t)} \\ \dot{y}(t) = \frac{\beta x(t)y(t)}{x(t)+y(t)} - \omega y(t) \\ \dot{k}(t) = sF(k(t), x(t)) - \phi k(t) \end{cases} \quad (94)$$

As  $F(k(t), x(t))$  is homogeneous of degree one, we can define  $z(t) = \frac{k(t)}{x(t)}$  and  $p(t) = \frac{y(t)}{x(t)}$  and rewrite (94) as

$$\begin{cases} \dot{p}(t) = \frac{\beta p(t)}{1+p(t)} - \omega p(t) - p(t)\left(\alpha - \frac{\beta p(t)}{1+p(t)}\right) = (\beta - \alpha - \omega)p(t) \\ \dot{z}(t) = sf(z(t)) - \phi z(t) - z(t)\left(\alpha - \frac{\beta p(t)}{1+p(t)}\right) \end{cases} \quad (95)$$

where  $f(z(t)) = f(z(t), 1) = \frac{F(k(t), x(t))}{x(t)}$

We wish to characterise the solution of the economic-epidemiological system (95) in the nonnegative orthant of the  $(p, z)$  plane. Our first task is to solve the static equations  $\dot{p}(t) = 0$  and  $\dot{z}(t) = 0$ . As the demographic-epidemiological factors  $\alpha$ ,  $\beta$  and  $\omega$  are constant when  $p(t)$  and  $z(t)$  are, the economic-epidemiological system has multiple steady states. Specifically, there are three points at which  $\dot{p}(t) = 0$  and  $\dot{z}(t) = 0$ :

(i)  $p^* = 0$  and  $z^* = 0$

Given that each input is essential to production ( $F(0, x(t)) = F(k(t), 0) = F(0, 0) = 0$ ) and that the demographic-epidemiological parameters  $\alpha$ ,  $\beta$  and  $\omega$  are bounded above by  $\bar{\alpha}$ ,  $\bar{\beta}$  and  $\bar{\omega}$  and below by zero, at this steady state the disease has been completely eradicated and the economy is irrelevant. From (89) it is evident that the susceptible population per susceptible individual grows at the rate  $\alpha(0)$ .

(ii)  $p^* = 0$  and  $z^* \neq 0$  such that  $sf(z^*) - \phi z^* - \alpha z^* = 0$

Since  $\alpha$  is constant in steady state, here we have the steady state of a standard Solow-Swan growth model in which there are no infected people. Then all the standard analysis of Golden Rule savings ratios for this steady state would apply. In steady state, as  $p^* = 0$ , the overall consumption per capita,  $c^*$ , is equal to  $f(z^*) - \phi z^* - \alpha z^*$  which is maximised over  $z^*$  at  $f'(z^*) - \phi - \alpha'z^* - \alpha = 0$ . The usual Golden Rule equates the net marginal



product of capital to the population growth rate. Here, it is equated to the marginal population growth rate allowing for the effects of  $z$  on population growth ( $f'(z^*) - \phi = \alpha'z^* + \alpha$ ) so long as the second order condition  $f''(z^*) - \alpha''z^* - 2\alpha' < 0$  holds. The Golden Rule savings ratio generates a steady state with a Golden Rule consumption level.

(iii) In this steady state the capital per susceptible worker ( $z^*$ ) is nonzero and constant. There is a root  $z^*$  which solves

$$\beta(z^*) - \alpha(z^*) - \omega(z^*) = 0 \quad (96)$$

From (96) we know that the TB infected/susceptible structure of the population is constant through time with a nonzero TB prevalence ( $p^* \neq 0$ ). Here the new susceptible births just balance the new infections net of TB infected deaths. Furthermore,

$$sf(z^*) - \phi z^* - z^* \left( \alpha - \frac{\beta p^*}{1 + p^*} \right) = 0 \quad (97)$$

where new investment just matches the depreciation of capital and the growth in the number of susceptible individuals. Solving (97) for  $p$  we have

$$p^* = - \frac{sf(z^*) - \phi z^* - \alpha z^*}{sf(z^*) - \phi z^* - \alpha z^* + \beta z^*} \quad (98)$$

We require the denominator to be nonzero. As only  $p^* \geq 0$  are acceptable steady states solutions, numerator and denominator in (98) need to have opposite signs. Furthermore, as  $\beta z > 0$ , the numerator has to be negative. Specifically, we know that  $sf(z^*) - \phi z^* - \alpha z^*$  is zero at  $z^* = 0$ . As according to the Inada conditions, the marginal product of capital per susceptible worker is very large for small capital per susceptible worker and the marginal product of capital per susceptible worker is very low for large capital per susceptible worker ( $f(z) \rightarrow \infty$  as  $z \rightarrow 0$  and  $f(z) \rightarrow 0$  as  $z \rightarrow \infty$ ), for low values of  $z$  the numerator is increasing since  $f'(0)$  is high. For sufficiently high values of  $z$ , the numerator is negative since concavity of  $f(z)$  leads the linear terms in



capital depreciation and susceptible net population growth to dominate. It follows that, for sufficiently high values of  $z$ , the numerator  $sf(z^*) - \phi z^* - \alpha z^*$  is negative. It vanishes at  $p^* = 0$  and  $z^* \neq 0$ , the second steady state.

Considering  $z_a$ ,  $z_b$  and  $z_c$  the roots which solve

$$\beta(z_a) - \alpha(z_a) - \omega(z_a) = 0 \quad (99)$$

$$sf(z_b) - \phi z_b - \alpha(z_b)z_b = 0 \quad (100)$$

$$sf(z_c) - \phi z_c - \alpha(z_c)z_c + \beta(z_c)z_c = 0 \quad (101)$$

It is possible to show that the steady state with  $p^* \neq 0$  and  $z^* \neq 0$  exists only for  $z_a > z_b$ .

In this case for any initial capital per susceptible worker ( $z$ ) within the range  $[0 < z < z_b]$ , capital accumulates and TB prevalence initially raises. TB prevalence reaches a maximum when the reduction in the work force due to the spread of the infectious disease has brought the level of  $z$  up to a point where the epidemiological situation is improved so much that TB prevalence starts falling. A reduction in the number of TB infected person corresponds to an increase in the number of susceptible individuals. The existing capital per susceptible worker is extended to new extra susceptible workers (capital widening effect) and  $z$  starts falling. Thereafter  $p$  and  $z$  cycle in a convergent way around the steady state with  $p^* \neq 0$  and  $z^* \neq 0$ . We can obtain the global phase-space diagram by plotting the stationary loci  $\dot{p} = 0$  and  $\dot{z} = 0$ . Given these, we know that at any point  $(p, z)$  to the left of  $\dot{p} = 0$  we have  $\dot{p} > 0$  and conversely. At any point  $(p, z)$  vertically below the  $\dot{z} = 0$  locus, we have  $\dot{z} > 0$  and conversely. Combining these patterns gives the directions of movements at each point in the phase-space.

For  $z_a < z_b < z_c$  the level of  $\beta - \alpha - \omega$  is relatively low compared with the case where  $z_a > z_b$ . In this case the steady state with  $p^* \neq 0$  and  $z^* \neq 0$



fails to exist. Here, any initial level of TB prevalence with low values of  $z$  yields a time path of increasing TB prevalence and capital per susceptible worker accumulation until TB prevalence reaches a maximum. At this point TB starts falling while capital per susceptible worker raises until the effect of the increase in the susceptible labour force (following the reduction in the TB prevalence) is strong enough to cause a fall in  $z$ . Regardless of its initial conditions, the economy converges to the stable steady state with  $p^* = 0$  and  $z^* \neq 0$ .

In the economic-epidemiological growth system for  $\beta - \alpha - \omega$  comparatively high the system converges to a point with a positive level of TB prevalence while for  $\beta - \alpha - \omega$  comparatively low the disease is eradicated. Sample trajectories are shown in Fig. 15a. and Fig. 15b for the two different possible combinations of  $\dot{p} = 0$  and  $\dot{z} = 0$ .

Local stability analysis around different steady states reinforces the global dynamics represented in Fig. 15a and Fig. 15b. We linearise the equations in (95) where  $p$  and  $z$  are now measured as deviations from a particular steady state and derivatives in the Jacobian are evaluated at that steady state. The Jacobian is

$$\begin{bmatrix} \beta - \alpha - \omega & (\beta' - \alpha' - \omega')p \\ z\beta/(1+p)^2 & sf' - sf/z - z(\alpha' - \beta'p/(1+p)) \end{bmatrix} \quad (102)$$

Around the steady state ( $p^* = 0$  and  $z^* = 0$ ) the Jacobian becomes

$$\begin{bmatrix} \beta - \alpha - \omega & 0 \\ 0 & sf' - \phi - \alpha \end{bmatrix} \quad (103)$$

so the diagonal elements are the eigenvalues which are both positive since, at  $z^* = 0$ ,  $f'(z)$  is high as, according to the Inada conditions,  $f(z) \rightarrow \infty$  as  $z \rightarrow 0$  and  $f(z) \rightarrow 0$  as  $z \rightarrow \infty$ . This steady state is characterized by local instability.

Around the steady state ( $p^* = 0$  and  $z^* \neq 0$ ) the Jacobian becomes



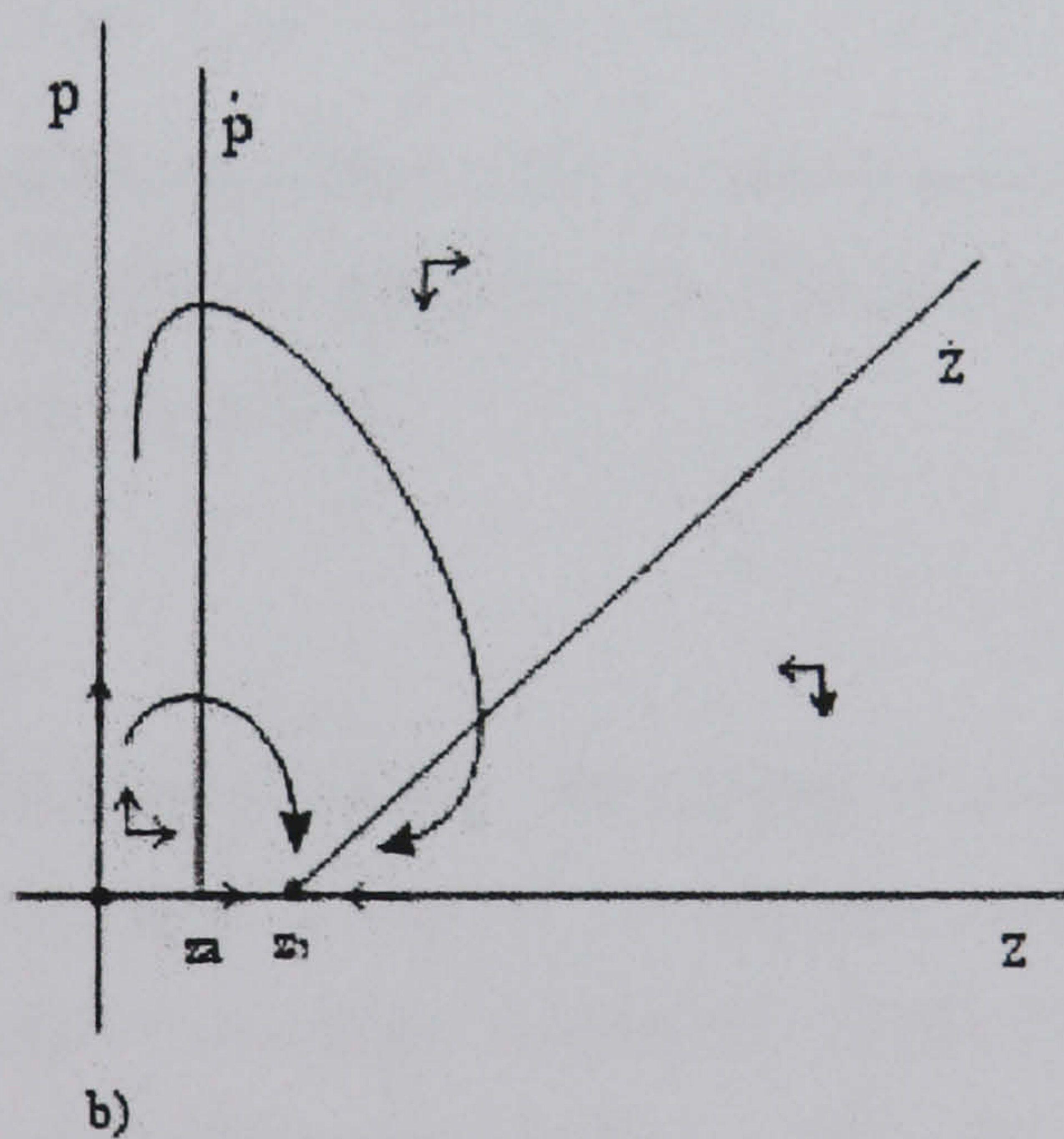
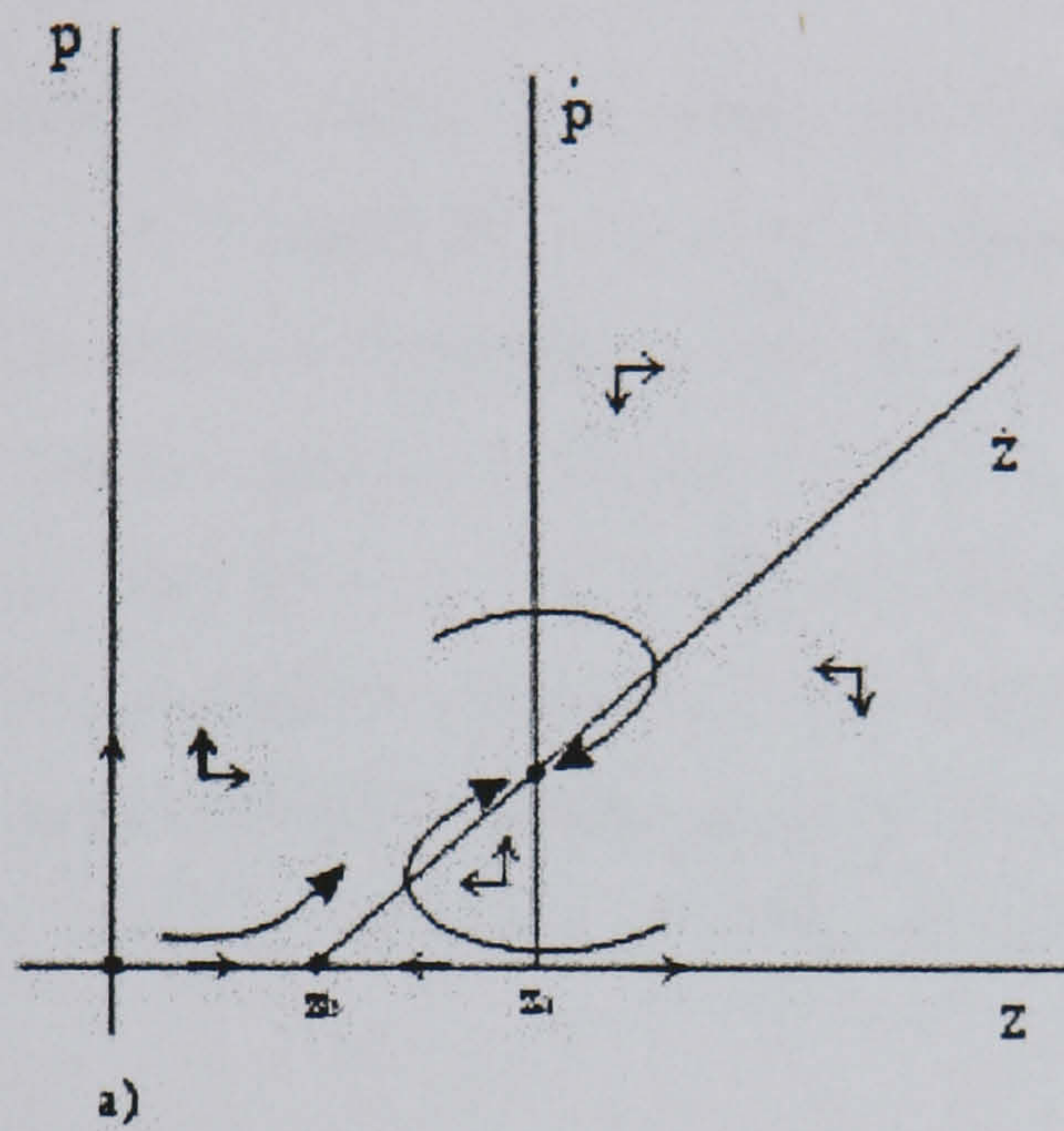

Figure 15: Phase-plane diagram, productive capital model: a) three steady states,  $z_a > z_b$ ; b) two steady states,  $z_a < z_b < z_c$



$$\begin{bmatrix} \beta - \alpha - \omega & 0 \\ \beta z & sf' - sf/z - \alpha'z \end{bmatrix} \quad (104)$$

At this steady state, if  $z_a > z_b$  (i.e. there are three steady states), we know that  $(\beta - \alpha - \omega) > 0$  since  $(\beta' - \alpha' - \omega')$  is assumed to be negative. The determinant of the matrix is negative and the steady state ( $p^* = 0$  and  $z^* \neq 0$ ) is locally a saddle point. Alternatively, if  $z_b > z_a$  (i.e. there are only two steady states) and  $(\beta - \alpha - \omega) < 0$  the trace is negative whilst the determinant is positive so that we have two eigenvalues with negative real parts. This leads to local stability (stable node or focus).

Around the steady state ( $p^* \neq 0$  and  $z^* \neq 0$ ), when it exists, the Jacobian becomes

$$\begin{bmatrix} 0 & (\beta' - \alpha' - \omega')p \\ \beta z/(1+p)^2 & sf' - sf/z - z(\alpha' - \beta'p/(1+p)) \end{bmatrix} \quad (105)$$

where the trace is negative and the determinant is positive. As the real parts of the two eigenvalues are both negative, the steady state ( $p^* \neq 0$  and  $z^* \neq 0$ ) is characterised by local stability.

#### 4.2.1 Calibration

We now turn to quantitative results. By means of a calibrated example we analyse the effect of productive capital investment on the economy's steady states equilibrium and we examine transition paths between steady states. To impose the Inada conditions we choose a Cobb-Douglas specification

$$f(z) = \frac{gz^a}{a} \quad \text{for } 0 < a < 1 \quad (106)$$

Here,  $g$  is the value for the scale of output and  $a$  represents the elasticity of output with respect to capital.<sup>196</sup> For the demographic-epidemiological

---

<sup>196</sup>Return to scale are constant to capital and labour.



variables we use the same logistic type functions as in Section 3.2.1. We refer to WHO and WB data<sup>197</sup> used in Section 4.1.1. With reference to the values of GNP per capita, we use data from the Region of Americas and the South-East Asia Region as representatives of high capital and low capital countries, respectively:  $\alpha_0 = 0.017$ ,  $\alpha_1 = 0.002$ ,  $\alpha_2 = 2$ ,  $\beta_0 = 0.028$ ,  $\beta_1 = 0.026$ ,  $\beta_2 = 3$ ,  $\omega_0 = 0.016$ ,  $\omega_1 = 0.030$ ,  $\omega_2 = 0.1$ ,  $a = 0.5$ ,  $\phi = 0.15$ ,  $g = 1$ . We select also two alternative values for the savings rates ( $s = 0.1$  and  $s = 0.05$ ) as varying the savings rate allows to reproduce the different possible dynamic patterns. With these parameter values, as  $z$  varies from 0 to  $\infty$ , the net population growth rate of the healthy people varies from 1.5 per cent to 1.7 per cent, the TB transmission coefficient from 28.8 per cent to 2.8 per cent and the total death rate of the infected individual from 4.6 per cent to 1.6 per cent.

For the case with three steady states ( $s = 0.05$ ) we have

$$(p_1^* = 0, z_1^* = 0) \quad (107)$$

$$(p_2^* = 0, z_2^* = 0.363) \quad (108)$$

$$(p_3^* = 3.292, z_3^* = 0.693) \quad (109)$$

Given the calibrated values the eigenvalues around the second and third steady states are

$$[-0.084, +0.055] \quad (110)$$

$$[-0.154, -0.005] \quad (111)$$

---

<sup>197</sup>World Bank, 2000; World Health Organization, 2000b, d.



The local dynamics around the second and third steady state are characterized by a saddle point and a stable node, respectively. The global phase-plane for the case with three steady states is illustrated in Fig. 16. Specifically, the third steady state with  $p^* \neq 0$  and  $z^* \neq 0$  is a global attractor. Regardless of initial conditions in  $p$  and  $z$ , the system tends towards the steady state with  $(p^* \neq 0$  and  $z^* \neq 0)$ . On paths starting with an initial value of capital per susceptible worker less than  $z_3^*$  (regardless of the initial values of  $p$ ),  $z$  is always increasing until the third steady state with  $p^* \neq 0$  and  $z^* \neq 0$  is reached. However, although there are paths along which  $p$  is always increasing, there are other paths along which  $p$  at first increases until it reaches a maximum. At this point, the level of  $z$  and consequently economic prosperity are high enough to make further economic prosperity increases reduce TB prevalence. For initial conditions with  $z > z_3^*$  capital per healthy worker decumulates. Paths starting with a value of  $p$  greater than  $p_3^*$  are characterised by a monotonically decreasing level of TB prevalence. Along paths starting with  $p < p_3^*$  the level of TB prevalence is always rising.

For the case with two steady states ( $s = 0.1$ ) we have

$$(p_1^* = 0, z_1^* = 0) \quad (112)$$

$$(p_2^* = 0, z_2^* = 1.436) \quad (113)$$

Given the calibrated values the eigenvalues around the second steady state are both real and of negative sign indicating the presence of a stable node

$$[-0.08, \quad -0.03] \quad (114)$$

In this case, for any initial value of TB prevalence, at first, rises and then falls while capital per healthy worker either increases or decreases depending



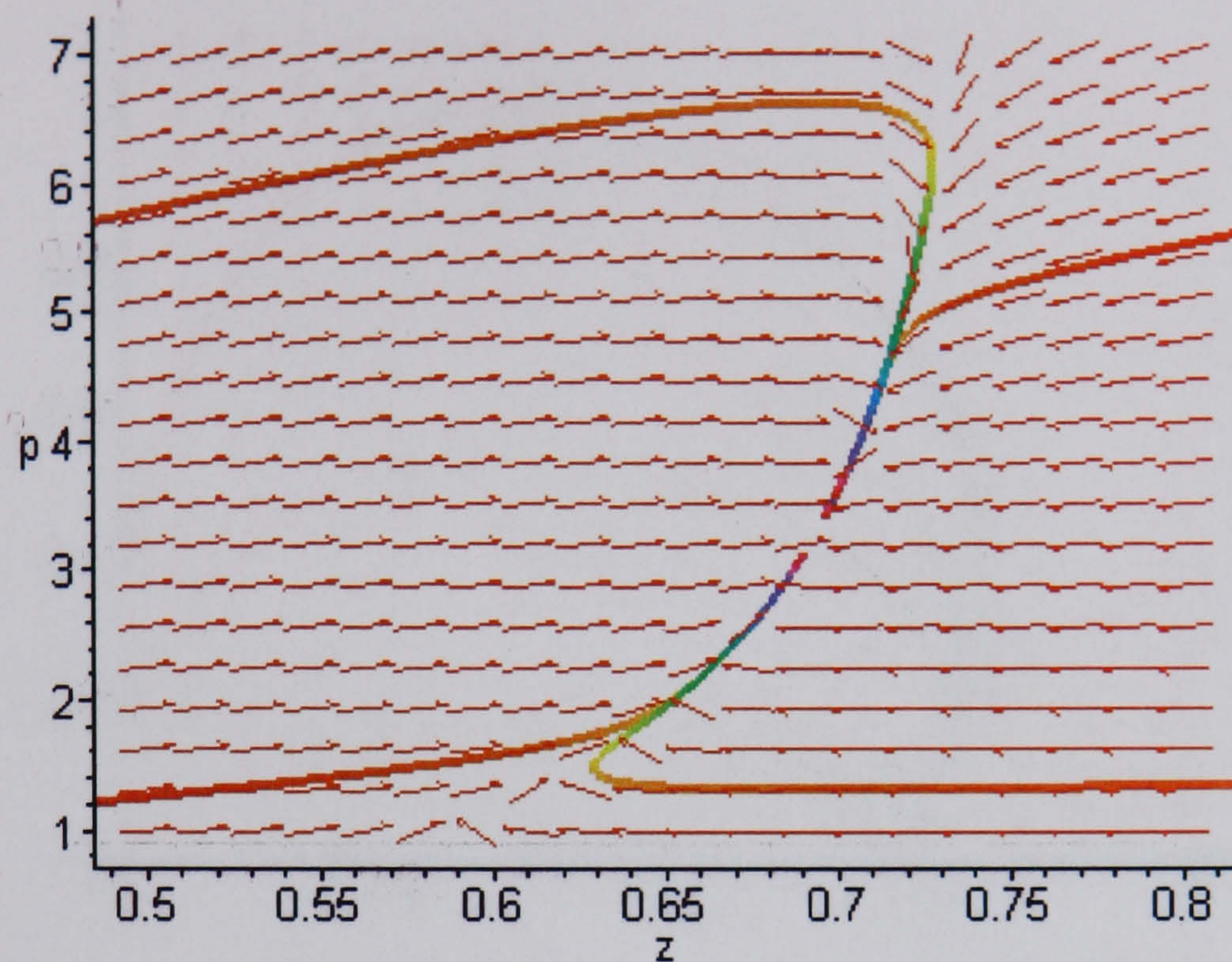

Figure 16: Global phase-plane diagram, economic-epidemiological model with productive capital, three steady states:  $s = 0.05$

on whether the initial conditions for  $z$  were less or greater than  $z_2^*$ . Regardless of the initial conditions in  $p$  and  $z$ , the system converges to the steady state with  $p_2^* = 0$  and  $z_2^* \neq 0$ . The phase space for the case with two steady states is shown in Fig. 17.

### 4.3 Optimal Control Analysis

Historically, apart from specific targeted regulatory actions as segregation, economic growth and improvements in knowledge, living and working conditions, which follow increases in economic prosperity, have been one of the major stimuli for the control of TB epidemics.<sup>198</sup>

In this Section we depart from the Solow-Swan model which takes the savings rate as exogenous and constant in that we analyse the case of a central planner who determines savings so that social welfare, determined by the accumulation of productive capital and by the level of TB prevalence, is

<sup>198</sup>Alvi et al., 1998; Netto et al., 1999; Watts, 1997.



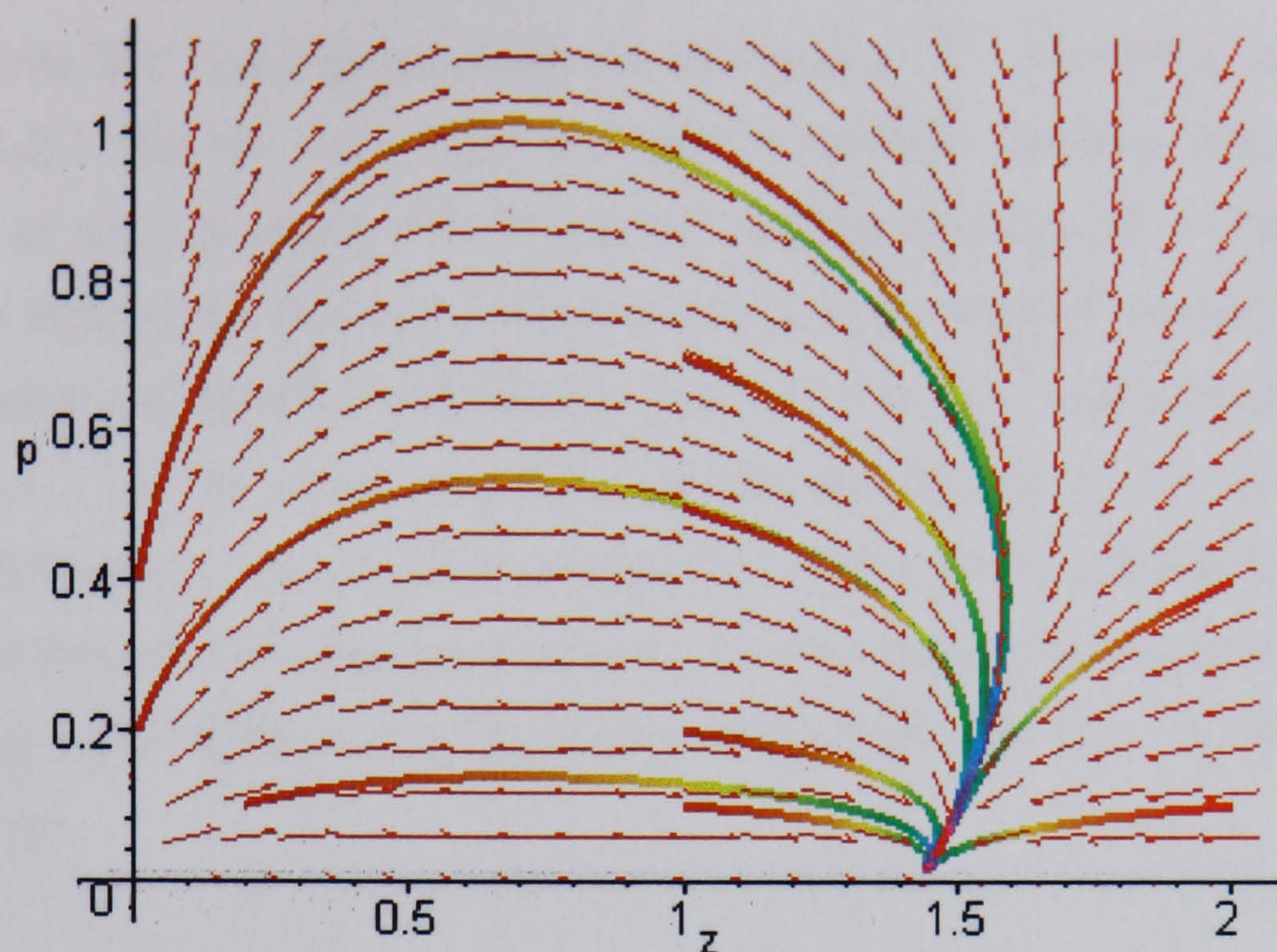

Figure 17: Global phase-plane diagram, economic-epidemiological model with productive capital, two steady states:  $s = 0.1$

maximised.<sup>199</sup> Specifically, we consider the framework of a non-linear optimal control problem with a control variable  $c$ , consumption per healthy worker ( $c = (1 - s)F(x(t), k(t))/x(t)$ ), and two states,  $p$  and  $z$ , the TB prevalence level and the level of productive capital, respectively.

In a centrally planned framework defining intertemporal and intratemporal welfare raises ethical issues due to the continuous evolution in the population and its composition.<sup>200</sup> There is also an intrinsic concern about time discounting. In the present context, following a line of argument developed by Pigou (1932), Harrod (1948), Rawls (1972), Dasgupta (1974), Solow (1974), Grout (1982), we refrain from discounting social welfare as "there

<sup>199</sup>A further approach is to consider a decentralised system in which healthy individuals set labour supply and savings to optimise their lifetime utility taking into account the chance of becoming infected and of dying. Similarly the infected individuals select their savings out of any rental income given their chance of death.

<sup>200</sup>Dasgupta, 1969; Meade, 1955; Yaari, 1981.



is no excuse for treating generations unequally".<sup>201</sup> However, as shown in Section 4.3.1 the use of a time discounted additive welfare function leaves the form of the necessary conditions essentially unchanged. A further problem is to determine at any  $t$  the intratemporal relative benefit of the TB infected and susceptible individuals. We select a time additive welfare function  $\int_0^T u(.) dt$ . In order to reflect the social welfare of the population at  $t$ , we take overall per capita consumption of the whole population,  $\frac{c}{(1+p)}$ , as one argument of  $u(.)$  implying that  $u(.)$  is increasing in  $c$  and decreasing in  $p$ . Moreover, we take  $u(.)$  to be a decreasing function of  $\dot{p}$ . At any  $t$  welfare is given by

$$\int_0^T u(c/(1+p), \dot{p}) dt \quad (115)$$

Using subscripts 1 and 2 for derivatives with respect to the first and second argument of  $u(c/(1+p), \dot{p})$  the marginal utility of overall per capita consumption is assumed to be positive ( $u_1 > 0$ ) and decreasing as overall per capita consumption increases ( $u_{11} < 0$ ). Utility is here assumed to increase but at a decreasing rate for positive changes in the level of TB prevalence ( $u_2 \leq 0$ , and  $u_{22} < 0$ ). Generally we also assume that the marginal utility of overall per capita consumption is neutral to changes in the level of TB prevalence ( $u_{12} = 0$ ) and that constant levels of TB prevalence do not cause any change in utility ( $u_2(c/(1+p), 0) = 0$ ). Furthermore, the marginal utility of overall per capita consumption is assumed to be infinitely large as the overall per capita consumption tends to zero ( $u_1 \rightarrow \infty$  as  $c/(1+p) \rightarrow 0$ ).

#### 4.3.1 Necessary Conditions for Optimality

The central planner facing a TB epidemic chooses his actions so that the division of output between consumption and productive capital is set to maximise social welfare. Consider the policy problem of finding  $c$ , the consumption flow, to maximise

---

<sup>201</sup>Solow, 1974, p.9.



$$\int_0^T u(c/(1+p), \dot{p}) dt \quad (116)$$

subject to

$$\dot{p}(t) = (\beta - \alpha - \omega)p(t) \quad (117)$$

$$\dot{z}(t) = f(z) - \phi z(t) - z(t)\left(\alpha - \frac{\beta p(t)}{1+p(t)}\right) - c \quad (118)$$

Defining the Hamiltonian<sup>202</sup> of the problem as

---

<sup>202</sup>With time discounting the analysis of this case has a welfare function

$$\int_0^T e^{-rt} u(c/(1+p), \dot{p}) dt \quad (f21)$$

where the discounted or present value Hamiltonian is

$$\begin{aligned} \bar{H} = e^{-rt} u(c/(1+p), \dot{p}) + \lambda_1 \left[ f(z) - \phi z(t) - z(t)\left(\alpha - \frac{\beta p(t)}{1+p(t)}\right) - c \right] \\ + \lambda_2 p(t)(\beta - \alpha - \omega) \end{aligned} \quad (f22)$$

By introducing the costate variables  $\xi_1$  and  $\xi_2$  and the Hamiltonian we have

$$\tilde{H} = u(c/(1+p), \dot{p}) + \xi_1 \left[ f(z) - \phi z(t) - z(t)\left(\alpha - \frac{\beta p(t)}{1+p(t)}\right) - c \right] + \xi_2 p(t)(\beta - \alpha - \omega) \quad (f23)$$

with  $\xi_1 = e^{-rt} \lambda_1$  and  $\xi_2 = e^{-rt} \lambda_2$  In this case the necessary conditions are

$$u_1 = \xi_1(1+p) \quad (f24)$$

$$\begin{aligned} \dot{\xi}_1 = \xi_1 [\alpha - \beta p/(1+p) - f' + \phi + z(\alpha' - \beta' p/(1+p))] \\ + \xi_1 r - (\xi_2 + u_2)(\beta' - \alpha' - \omega')p \end{aligned} \quad (f25)$$

$$\dot{\xi}_2 = \xi_1 [c/(1+p) - \beta z/(1+p)^2] - (\xi_2 + u_2)(\beta - \alpha - \omega) + r(\xi_2 + u_2) \quad (f26)$$



$$H = u(c/(1+p), \dot{p}) + \lambda_1 \left[ f(z) - \phi z(t) - z(t) \left( \alpha - \frac{\beta p(t)}{1+p(t)} \right) - c \right] + \lambda_2 p(t)(\beta - \alpha - \omega) \quad (119)$$

we have the following first order optimality conditions

$$\frac{\delta H}{\delta c} = \frac{u_1}{(1+p)} - \lambda_1 = 0 \quad (120)$$

where  $u_1 = \frac{\delta u}{\delta(\frac{c}{1+p})}$ , which yields

$$u_1 = \lambda_1(1+p) \quad (121)$$

where the marginal utility of consumption per overall capita divided by  $(1+p)$  is equated to the marginal value of productive capital per healthy worker.

The equations of motion for the costate variables,  $\lambda_1$  and  $\lambda_2$ , respectively, are

$$-\frac{\delta H}{\delta p} = \dot{\lambda}_2 = \lambda_1 [c/(1+p) - \beta z/(1+p)^2] - (\lambda_2 + u_2)(\beta - \alpha - \omega) \quad (122)$$

$$-\frac{\delta H}{\delta z} = \dot{\lambda}_1 = \lambda_1 [\alpha - \beta p/(1+p) - f' + \phi + z(\alpha' - \beta' p/(1+p))] - (\lambda_2 + u_2)(\beta' - \alpha' - \omega')p \quad (123)$$

---

Equations (119) and (f26) can be re-written as

$$\dot{\xi}_1 = \xi_1 [\alpha - \beta p/(1+p) - f' + \phi + z(\alpha' - \beta' p/(1+p)) + \tau] - (\xi_2 + u_2)(\beta' - \alpha' - \omega')p \quad (f27)$$

and

$$\dot{\xi}_2 = \xi_1 [c/(1+p) - \beta z/(1+p)^2] - (\xi_2 + u_2)(\beta - \alpha - \omega - \tau) \quad (f28)$$

Discounting affects the steady state values of the costate variables and adds a growth term to their dynamics.



Equations (117)-(118)-(121)-(122)-(123) are necessary conditions for optimality. In Section 4.3.4 we consider their sufficiency and also whether a solution exists to the problem. Equation (122) indicates that the imputed value of TB prevalence for the future rises because of its effects in reducing the instantaneous utility. To see this effect, recall that TB prevalence enters the utility function via the overall per capita consumption ( $c/(1+p)$ ) which implies that utility is decreasing in  $p$ . Furthermore, (122) also provides evidence that the value of TB prevalence increases also because of the future growth of TB prevalence (here  $(\beta - \alpha - \omega)$  represents the changes in the TB prevalence level). Recall that  $\lambda_2 < 0$  and  $u_2 \leq 0$ . However, from (122) it is clear that TB prevalence shadow price falls because of its effects on the future value of investment. An increase in the number of TB infected people and consequently the reduction of the number of susceptible people (healthy workers) leads to an increase in the productive capital per susceptible worker,  $z$  (capital "narrowing" effect). Here,  $\beta z/(1+p)^2$  represents the change in value of productive capital per susceptible worker caused by a change in TB prevalence. Next (123) indicates that the imputed value of productive capital per susceptible worker increases because the capital widening effect raises the susceptible birth rate ( $\alpha' \geq 0$ ) and reduces the TB transmission rate ( $\beta' \leq 0$ ). The shadow price of productive capital per susceptible worker increases also because of the depreciation effect. Furthermore, from (123) we can infer that, as capital deepening alters the growth of TB infection and of TB prevalence, it changes the marginal value of the population structure in the future. The shadow price of productive capital per susceptible worker falls also because of the reduction in the marginal productivity of capital ( $f'\lambda_1$ ) and because of ( $\lambda_1\beta p/(1+p)$ ). Both (122) and (123) imply that, on one margin, higher TB prevalence is socially desirable as it increases the capital deepening effect of a given amount of investment by having fewer susceptible workers available to use it. Higher capital deepening effect translates in a higher productive capital per healthy worker and consequently either in higher consumption or further productive capital investment. However, it reduces the value of



current overall per capita consumption of the whole population,  $c/(1+p)$ .

### 4.3.2 Dynamic Analysis

To analyse the dynamic properties of the system in (117)-(118)-(121)-(122)-(123) we examine the steady states. Under the assumption that  $\alpha > 0$  and  $\alpha' \geq 0$ , the system has two steady states. At the first steady state the disease has been completely eradicated ( $p^* = 0$ ). Here, the Golden Rule of a growth model applies with the rate of change of the susceptible class per susceptible individual given by  $\alpha$ . Knowing  $p^* = 0$ , (118) becomes

$$\dot{z}(t) = f(z) - \phi z(t) - \alpha z(t) - c \quad (124)$$

and the steady state productive capital per healthy worker,  $z^*$ , which maximises steady state utility  $u(c/(1+p), 0)$ , solves

$$f' - \phi - \alpha - \alpha' z^* = 0 \quad (125)$$

At this steady state, equations (122) and (123) can be rewritten, respectively, as

$$-\frac{\delta H}{\delta p} = \dot{\lambda}_2 = \lambda_1^* (c^* - \beta z^*) - \lambda_2^* (\beta - \alpha - \omega) = 0 \quad (126)$$

$$\begin{aligned} -\frac{\delta H}{\delta z} = \dot{\lambda}_1 &= -\lambda_1^* \{ \beta p^* / (1 + p^*) + f' - \phi - \alpha - z^* [\alpha' - \beta' p^* / (1 + p^*)] \} \\ &\quad - (\lambda_2^* + u_2) (\beta' - \alpha' - \omega') p^* = 0 \end{aligned} \quad (127)$$

where (127) is automatically zero as  $p^* = 0$  and  $f' - \phi - \alpha - \alpha' z^* = 0$ .

For  $p^* = 0$ , (118) can be rewritten as

$$c^* = f(z) - \phi z(t) - \alpha z(t) \quad (128)$$



Here (128) sets  $u_1$ . From (121) we know that

$$u_1 = \lambda_1^* \quad (129)$$

and that  $\lambda_2^*$  satisfies

$$\lambda_1^* [c^* - \beta(z^*)z^*] - \lambda_2^* [\beta(z^*) - \alpha(z^*) - \omega(z^*)] \quad (130)$$

Recall that, as  $\dot{p}^* = 0$ , we have  $u_2^* = 0$ . The sign of  $\lambda_2^*$  is ambiguous as it depends on whether  $[c^* - \beta(z^*)z^*]$  is greater or less than zero. As a change in TB prevalence does not contribute to the decay of the level of productive capital per susceptible worker (here  $\frac{\delta z}{\delta p} > 0$ ) the model does not satisfy the most common condition<sup>203</sup> imposed for negativity of  $\lambda_2$ . However, as stated in Section 4.3.4,  $\lambda_2 < 0$  is part of a set of sufficiency conditions for optimality of the solutions to these equations (117)-(118)-(121)-(122)-(123).

The second steady state has  $p^* \neq 0$ . This satisfies the equations

$$u_1 = \lambda_1^*(1 + p) \quad (131)$$

$$[\beta(z^*) - \alpha(z^*) - \omega(z^*)] = 0 \quad (132)$$

$$\dot{z}(t) = \left[ f(z^*) - \phi z^* - z^* \left( \alpha - \frac{\beta p^*}{1 + p^*} \right) - c^* \right] = 0 \quad (133)$$

$$\begin{aligned} -\frac{\delta H}{\delta z} &= \dot{\lambda}_1 = \lambda_1^* \{ \alpha - \beta p^*/(1 + p^*) - f' + \phi + z^* [\alpha' - \beta' p^*/(1 + p^*)] \} \\ &\quad - (\lambda_2^* + u_2) (\beta' - \alpha' - \omega') p^* = 0 \end{aligned} \quad (134)$$

$$-\frac{\delta H}{\delta p} = \dot{\lambda}_2 = \lambda_1 [c/(1 + p^*) - \beta z^*/(1 + p^*)^2] = 0 \quad (135)$$

---

<sup>203</sup>The lengthy assumption (ii) in Theorem 1 in Leonard (1981).



implying either  $\lambda_1^* = 0$  (which is impossible under the assumption made here that  $u_1 > 0$ ) or

$$(1 + p^*)c^* = \beta z^* \quad (136)$$

Solving (133) for  $p$ , after having substituted (136) in it, we obtain

$$p^* = -\frac{f(z^*) - \phi z^* - \alpha z^*}{f(z^*) - \phi z^* - \alpha z^* + \beta z^*} \quad (137)$$

$$c^* = f(z^*) - \phi z^* - \alpha z^* + \beta z^* \quad (138)$$

Here, (132) defines  $z^*$ , (134) sets  $\lambda_2^*$  and  $\lambda_1^*$  is given by

$$\lambda_1^* = \frac{u_1 [\beta z^* / (1 + p^*)^2]}{(1 + p^*)} \quad (139)$$

We can show that

$$p_d - p_o > 0 \quad (140)$$

where  $p_d$  and  $p_o$  are the steady state TB prevalence levels in the deterministic case (98) and in the optimal control case (137), respectively. From (98) and (137) we know that the denominators are positive as a condition for  $p_d$  and  $p_o$  to be positive and feasible solutions. As

$$p_d - p_o = \frac{fz\beta(1-s)}{[sf - z(\phi + \alpha - \beta)][f - z(\phi + \alpha - \beta)]} \quad (141)$$

where  $fz\beta(1-s) > 0$  then  $p_d - p_o$  is always positive. In the deterministic case there is a higher TB prevalence than in the model with an optimised savings ratio.



The local stability analysis of the system of non-linear equations (117)-(118)-(121)-(122)-(123) depends on the eigenvalues of the Jacobian. The Jacobian of the linearized system, calculated by the use of a program written in MAPLE 6.01 (see Appendix A.3 for detailed calculations), has the qualitative structure

$$\begin{bmatrix} -\pi & a & 0 & 0 \\ b & c - \pi & d & 0 \\ f & e & -d - \pi & -a \\ e & f & -b & -\pi \end{bmatrix} \quad (142)$$

where the characteristic equation is

$$\pi^4 - \pi^2[c^2 + 2ab + ed] + [a^2b^2 - a^2dg] \quad (143)$$

Reparametrising (143) we have

$$\Pi^2 - \Pi A + B \quad (144)$$

where

$$\Pi = \pi^2 \quad (145)$$

$$A = [c^2 + 2ab + ed] \quad (146)$$

$$B = [a^2b^2 - a^2dg] \quad (147)$$

If both  $(A^2 - 4B)$  and  $(-A - \sqrt{(A^2 - 4B)})$  are positive, there are two pairs of real roots of equal absolute value but of opposite sign leading to a 4-D saddle point. When  $(A^2 - 4B)$  is positive and  $(-A \pm \sqrt{(A^2 - 4B)})$  is negative then there are two pairs of imaginary roots. When both  $(A^2 - 4B)$



and  $(-A + \sqrt{(A^2 - 4B)})$  are positive and  $(-A - \sqrt{(A^2 - 4B)})$  is negative, then there is one pair of pure imaginary and a pair of real roots of opposite sign. When  $(A^2 - 4B)$  is negative we have two pairs of complex conjugate roots with the common real part of each pair being of equal absolute value but opposite sign. This is combination of a 4-D saddle point and locally oscillatory solutions. Summarising, the possibilities are shown in Table 4.2

$(A^2 - 4B)$	$> 0$	$> 0$	$> 0$	$< 0$
$(-A - \sqrt{(A^2 - 4B)})$	$> 0$	$< 0$	$< 0$	
$(-A + \sqrt{(A^2 - 4B)})$		$< 0$	$> 0$	
	4-D saddle	focus	cycles	4-D saddle with local oscillations

Table 4.2: Optimal control of productive capital investment model, local dynamics

**Golden Rules** Consider now the problem of selecting steady state values of  $p$  and  $z$  which maximise  $c/(1+p)$  and satisfy the steady state conditions<sup>204</sup>

$$\dot{p} = [\beta(z) - \alpha(z) - \omega(z)]p = 0 \quad (148)$$

$$\frac{\left[ f(z) - \phi z - z \left( \alpha - \frac{\beta p}{1+p} \right) \right]}{(1+p)} = \frac{c}{(1+p)} \quad (149)$$

There are two possibilities. We can have  $p$  which maximises<sup>205</sup> (149) and

<sup>204</sup>Here (149) is obtained by setting  $\dot{z}(t) = 0$  from which we have

$$\left[ f(z) - \phi z - z \left( \alpha - \frac{\beta p}{1+p} \right) \right] = c \quad (f29)$$

or, dividing both sides by  $(1+p)$

$$\frac{\left[ f(z) - \phi z - z \left( \alpha - \frac{\beta p}{1+p} \right) \right]}{(1+p)} = \frac{c}{(1+p)} \quad (f30)$$

<sup>205</sup>For  $(\beta - \alpha - \omega) = 0$ .



so solves<sup>206</sup>

$$f(z^*) - \phi z^* - z^* \alpha = -\beta z^* \frac{1 - p^*}{1 + p^*} \quad (150)$$

---

<sup>206</sup>This is actually a local maximum of  $\frac{c}{(1+p)}$  in  $p$  as at this value

$$\frac{\delta^2(c/(1+p))}{\delta p^2} = -\frac{2\beta z}{(1+p)^3} < 0 \quad (f31)$$



and  $z^*$  set by (148) yielding<sup>207</sup>

$$\frac{\beta z^*}{(1+p^*)^2} = \frac{c^*}{(1+p^*)} \quad (151)$$

and from (150) we know

$$p^* = -\frac{f(z^*) - \phi z^* - \alpha z^*}{f(z^*) - \phi z^* - \alpha z^* + \beta z^*} > 0 \quad (152)$$

---

<sup>207</sup>Here, in order to maximise  $\frac{[f(z) - \phi z - z(\alpha - \frac{\beta p}{1+p})]}{(1+p)}$  with respect to  $p = 0$ , we set

$$\frac{\delta \frac{[f(z) - \phi z - z(\alpha - \frac{\beta p}{1+p})]}{(1+p)}}{\delta p} = 0 \quad (f32)$$

from which

$$\frac{[f(z) - \phi z - z(\alpha - \frac{\beta p}{1+p})]}{(1+p)^2} - \frac{\beta z}{(1+p)} = 0 \quad (f33)$$

or

$$\left[ f(z) - \phi z - z \left( \alpha - \frac{\beta p}{1+p} \right) \right] = \frac{\beta z}{(1+p)} \quad (f34)$$

It follows that

$$f(z) - \phi z - \alpha z = \frac{\beta z(1-p)}{(1+p)} \quad (f35)$$

by substituting (f35) in (149) we have

$$\frac{\frac{\beta z(1-p)}{(1+p)} + \frac{\beta z}{(1+p)}}{(1+p)} = \frac{c}{(1+p)} \quad (f36)$$

or

$$\frac{\beta z}{(1+p)^2} = \frac{c}{(1+p)} \quad (f37)$$



Alternatively, (148) holds also for  $p^* = 0$ . Here (149) becomes

$$f(z^*) - \phi z^* - z^* \alpha = c^* \quad (153)$$

which is maximised on  $z^*$  when

$$f' - \phi - \alpha - \alpha z^* = 0 \quad (154)$$

As both these solutions are local maxima both have a Golden Rule interpretation.

### 4.3.3 Calibration

In this Section the parameter values are numerically calibrated such that the initial model equilibrium replicates a given observed benchmark data set. To analyse the optimal trajectory and compare it with the deterministic case we limit our analysis to the case of an isoelastic utility so that

$$u(c/(1+p), \dot{p}) = \frac{[c/(1+p)]^{(1-b)}}{(1-b)} \quad \text{with } b > 0 \quad (155)$$

and, as in Section 4.2.1, we use logistic type functions for the demographic-epidemiological variables

$$\alpha(z(t)) = \alpha_0 - \alpha_1 \exp^{-\alpha_2 z(t)} \quad \text{for } \alpha > 0 \quad (156)$$

$$\beta(z(t)) = \beta_0 + \beta_1 \exp^{-\beta_2 z(t)} \quad \text{for } \beta > 0 \quad (157)$$

$$\omega(z(t)) = \omega_0 + \omega_1 \exp^{-\omega_2 z(t)} \quad \text{for } \omega > 0 \quad (158)$$



We refer to the same data set<sup>208</sup> as in Section 4.2.1. We have:  $\alpha_0 = 0.017$ ,  $\alpha_1 = 0.002$ ,  $\alpha_2 = 2$ ,  $\beta_0 = 0.028$ ,  $\beta_1 = 0.026$ ,  $\beta_2 = 3$ ,  $\omega_0 = 0.016$ ,  $\omega_1 = 0.030$ ,  $\omega_2 = 0.1$ ,  $a = 0.5$ ,  $\phi = 0.15$ ,  $g = 1$  and  $b = 2$ . Recall that with these parameter values, as  $z$  varies from 0 to  $\infty$ , the net population growth rate of the healthy people varies from 1.5 per cent to 1.7 per cent, the TB transmission coefficient from 28.8 per cent to 2.8 per cent and the total death rate of the infected individual from 4.6 per cent to 1.6 per cent.

With these parameter values the steady state with  $p^* \neq 0$  does not exist.<sup>209</sup> The control system exhibits one steady state at

$$(p^* = 0, z^* = 35.86, \lambda_1^* = 0.03, \lambda_2^* = -23.84) \quad (159)$$

At this steady state, consumption per healthy worker is 5.99 and the level of utility is -0.167. This is also the value of the Hamiltonian at the steady state. The eigenvalues for the calibrated case are

$$[\pm.0835] \quad \text{and} \quad [\pm.0058] \quad (160)$$

revealing the existence of a 4-D saddle point. As the eigenvalues are all real the steady state exhibits no oscillations.

As plotting the global phase diagram of the economic-epidemiological system with four non-linear equations would require a graph in four dimensions, we use here a mathematical device, which allows display of the results whilst remaining in three dimensions. Specifically, as along any solution path for  $[p(t), z(t), \lambda_1(t), \lambda_2(t)]$  the Hamiltonian is identically constant<sup>210</sup> we integrate around contours of the Hamiltonian. Along any solution path

---

<sup>208</sup>World Bank, 2000; World Health Organization, 2000b, d.

<sup>209</sup>The steady state with  $p^* \neq 0$  generally requires a relatively high infection rate,  $\beta$ .

<sup>210</sup>Dankowicz, 1997.



$$\begin{aligned}
\bar{H} &= u \left( \frac{c(\lambda_1(t), p(t))}{(1+p(t))} \right) \\
&+ \lambda_1(t) \left[ f(z(t)) - \phi z(t) - z(t) \left( \alpha - \frac{\beta p(t)}{1+p(t)} \right) - c(\lambda_1(t), p(t)) \right] \\
&+ \lambda_2(t) [(\beta - \alpha - \omega)p(t)]
\end{aligned} \tag{161}$$

We then solve for  $\lambda_2(t)$

$$\begin{aligned}
\lambda_2(t) &= \frac{\left[ \bar{H} - u \left( \frac{c(\lambda_1(t), p(t))}{(1+p(t))} \right) \right]}{[(\beta - \alpha - \omega)p(t)]} \\
&- \frac{\lambda_1(t) \left[ f(z(t)) - \phi z(t) - z(t) \left( \alpha - \frac{\beta p(t)}{1+p(t)} \right) - c(\lambda_1(t), p(t)) \right]}{[(\beta - \alpha - \omega)p(t)]}
\end{aligned} \tag{162}$$

where  $\bar{H}$  is the constant value of the Hamiltonian on the surface. By substituting the expression (162) for  $\lambda_2(t)$  into the differential equations for the other variables  $p(t)$ ,  $z(t)$  and  $\lambda_1(t)$ , we reduce the system to three dimensions without losing any information. In this case, as  $\lambda_2$  only enters the differential equation for  $\lambda_1$ , the constraint that the 3-D solution lies on the Hamiltonian surface only enters this equation. Therefore, in the  $\dot{\lambda}_1$  equation (123) we substitute the term in  $\lambda_2$  with the expression in (162). The three dimensional global phase space in  $[p(t), z(t), \lambda_1(t)]$  is shown in Fig. 18.

The three dimensional diagram shows paths of  $[p(t), z(t), \lambda_1(t)]$  on the surface of the Hamiltonian ( $\bar{H} = -0.171$ ). Recall that the steady state is at  $(p^* = 0, z^* = 35.86, \lambda_1^* = 0.03, \lambda_2^* = -23.84)$ . The critical determinant of the qualitative nature of the paths is whether initially  $z$  is above or below  $z^*$ . If initially  $z < z^*$  then  $p(t)$  falls monotonically whilst initial capital accumulation ( $z(t)$  rises) is followed by capital decumulation to  $z(T) = 0$ . On such paths  $\lambda_1(t)$  slowly rises. An example of the time behaviour of the four variables on such a path is given in Figs. 19, 20, 21, 22. Notice that paths of this type satisfy the transversality conditions. For  $z > z^*$  and  $\lambda_1$  very low, on the Hamiltonian surface the path involves decumulation of



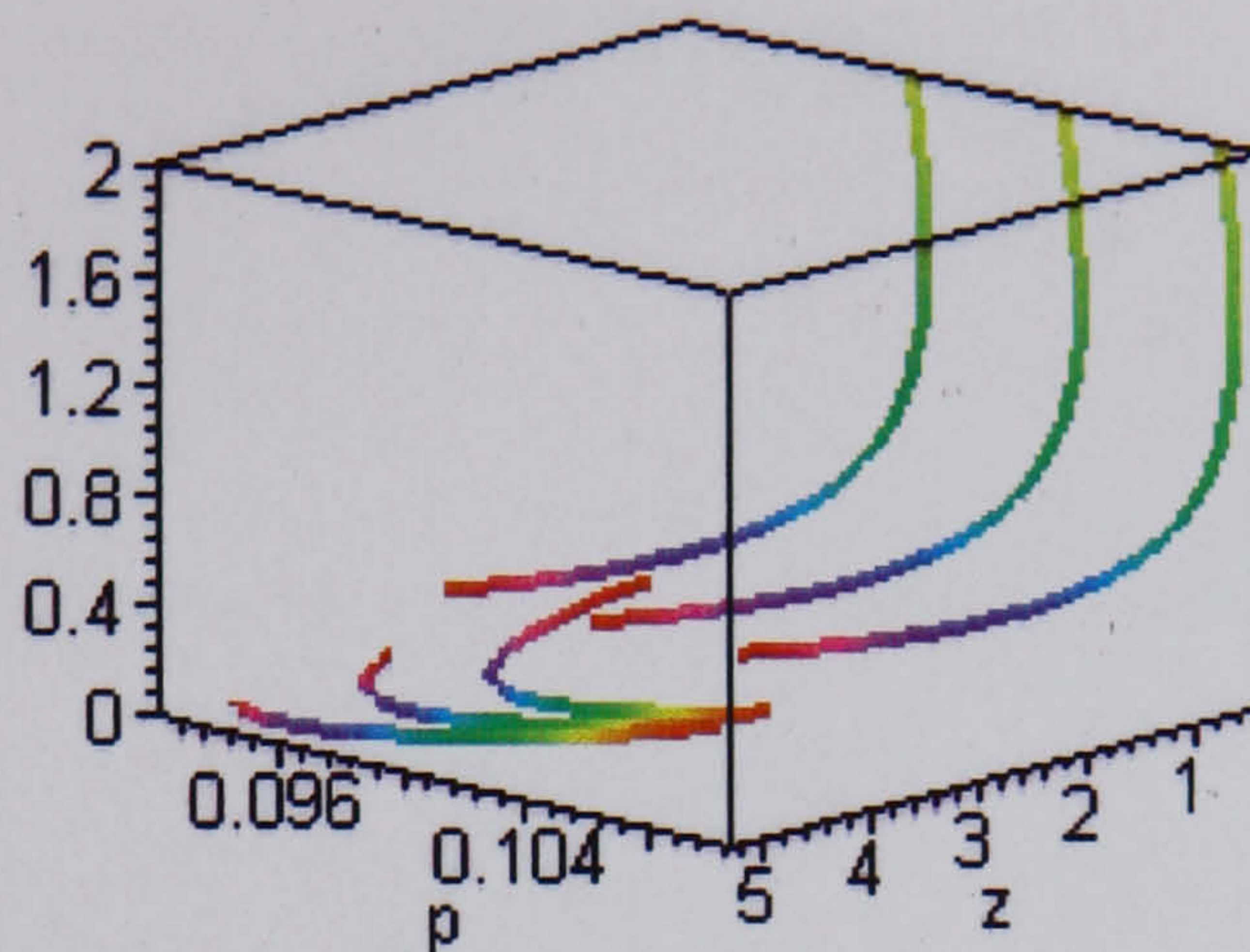

Figure 18: Global phase-space diagram, optimal control for the productive capital model,  $p^* = 0$

capital to zero, an initial rise, but subsequently fall of  $\lambda_1$  towards zero and TB prevalence  $p$  is only slowly changing but moves towards zero. Paths of this type also satisfy the transversality conditions and so are optimal. Figs. 23, 24, 25, 26 show the time behaviour of the four variables on such a path. If initially  $z > z^*$  and  $\lambda_1$  is not too far below  $\lambda_1^*$  then on the constant surface of the Hamiltonian initially  $z(t)$  falls but subsequently rises whilst  $\lambda_1$  rises and remains above the steady state value. In general paths of this form do not satisfy the transversality conditions.

#### 4.3.4 Sufficient Conditions for Optimality

In this Section the sufficiency of the necessary conditions for optimal control are analysed. For simplicity, at first we analyse the case in which  $\alpha$ ,  $\beta$  and  $\omega$  are constants. The problem is to determine the optimal allocation between consumption and investment so that social welfare is maximised. Here  $p(t)$  follows an exogenous time trend, growing or falling at rate  $(\beta - \alpha - \omega)$  and affects the accumulation process of  $z$  and preferences. We use the sufficiency argument to show that, if  $u(\cdot)$  and  $f(\cdot)$  are concave then the necessary conditions for optimality are sufficient so long as  $\lim_{t \rightarrow \infty} \lambda_1(t)z(t) = 0$ . Detailed



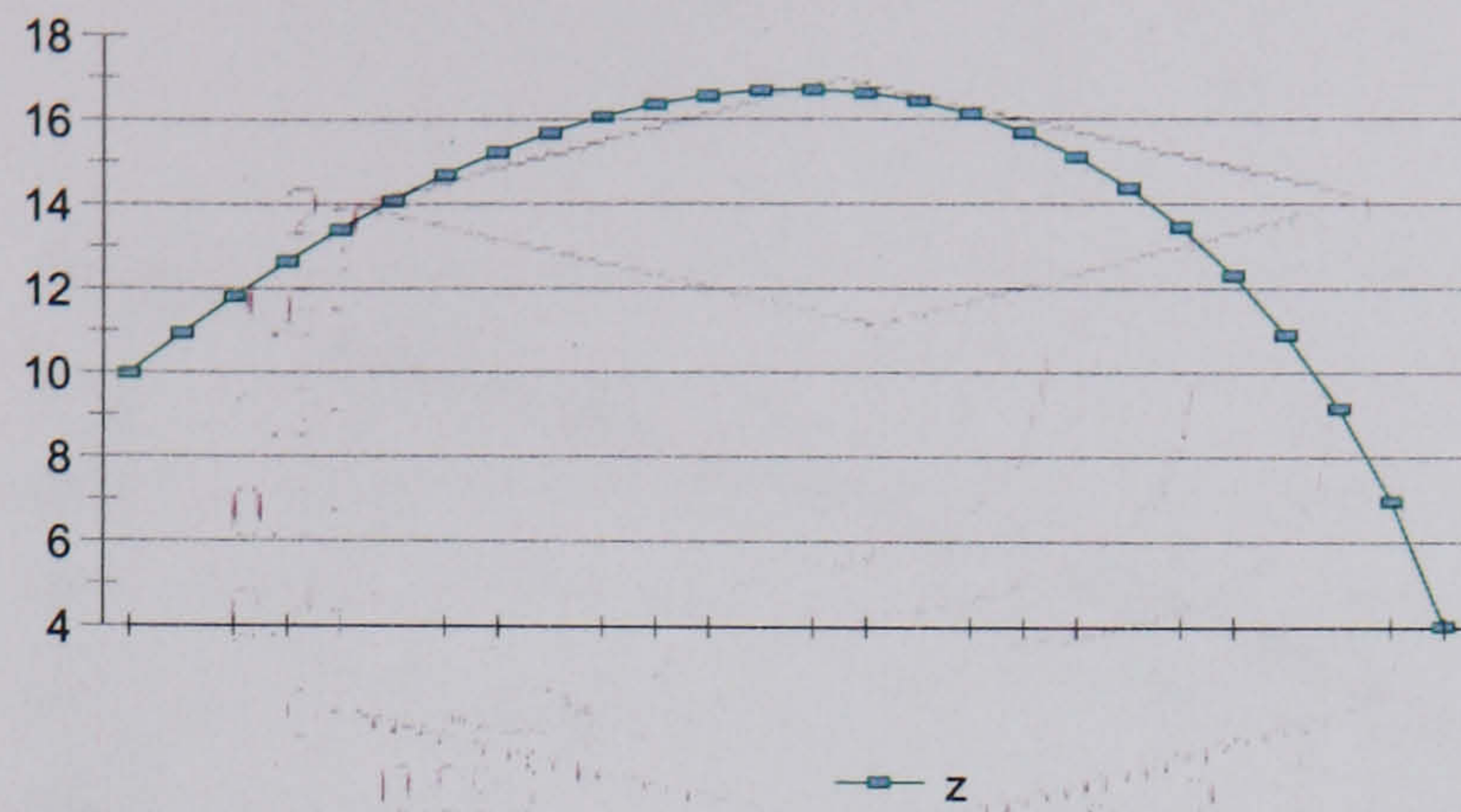

Figure 19: Time behaviour of  $z$  for  $z(0) = 10$

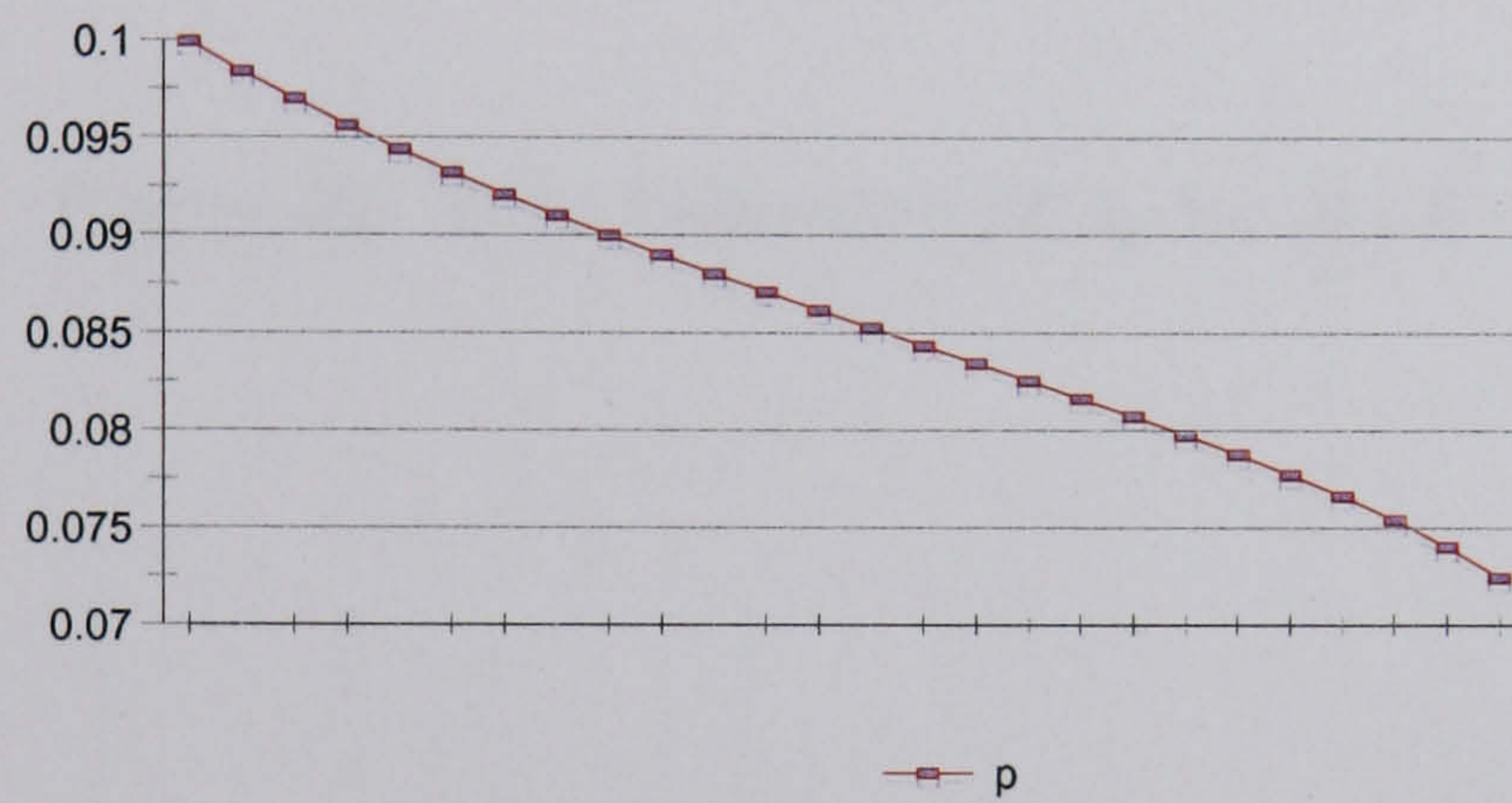

Figure 20: Time behaviour of  $p$  for  $p(0) = 0.1$

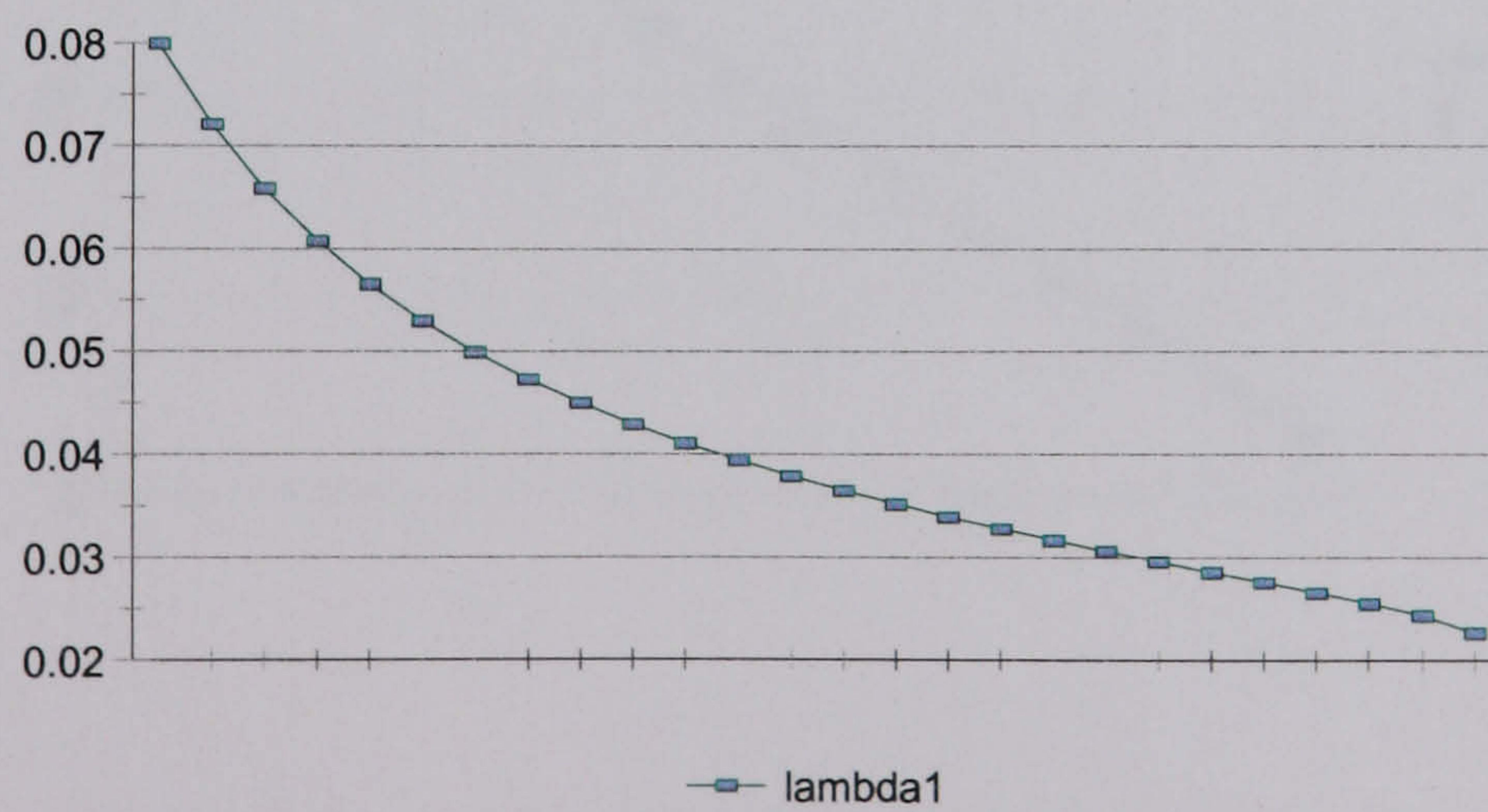

Figure 21: Time behaviour of  $\lambda_1$  for  $\lambda_1(0) = 0.08$



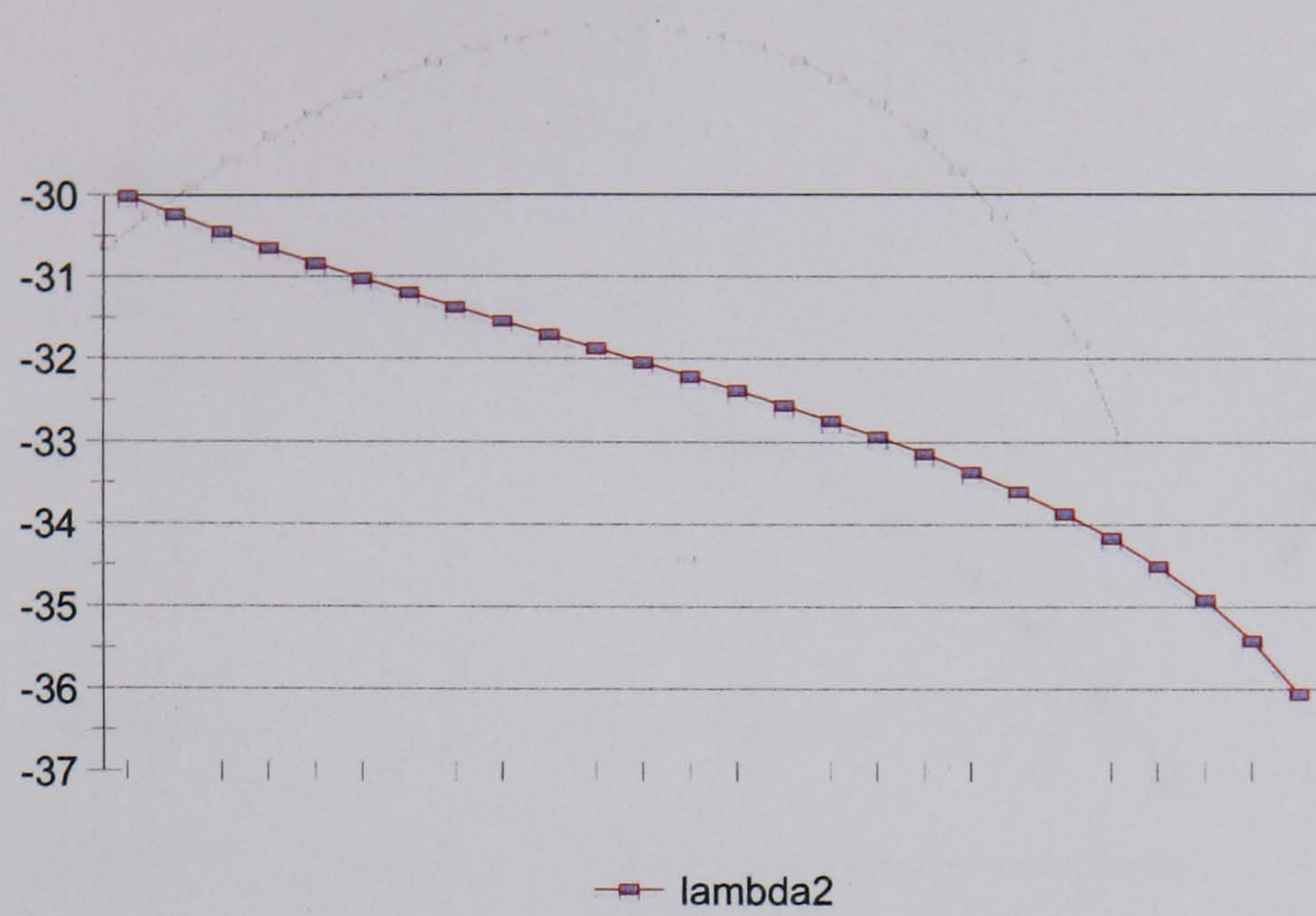

Figure 22: Time behaviour of  $\lambda_2$  for  $\lambda_2(0) = -30$

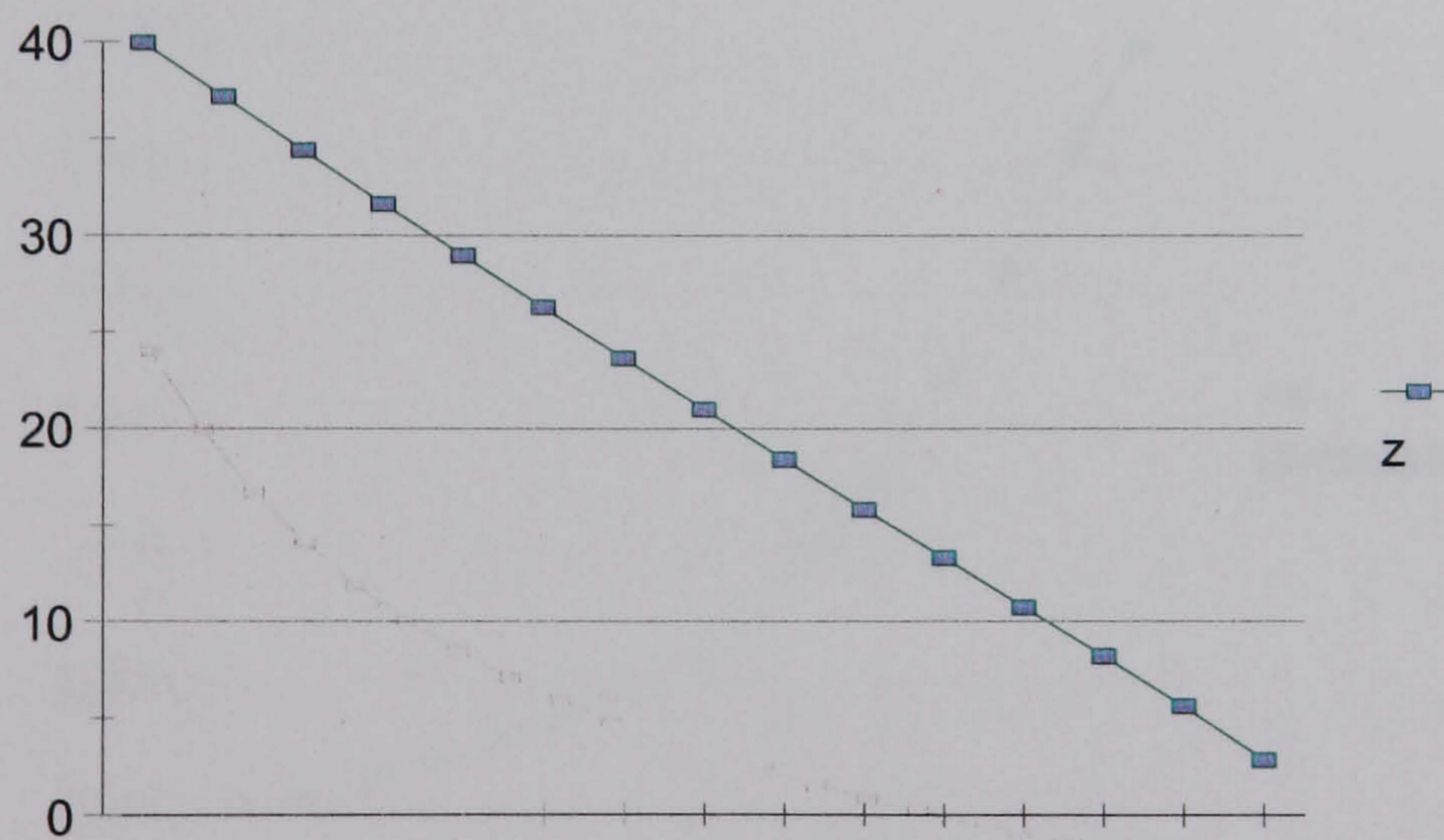

Figure 23: Time behaviour of  $z$  for  $z(0) = 10$



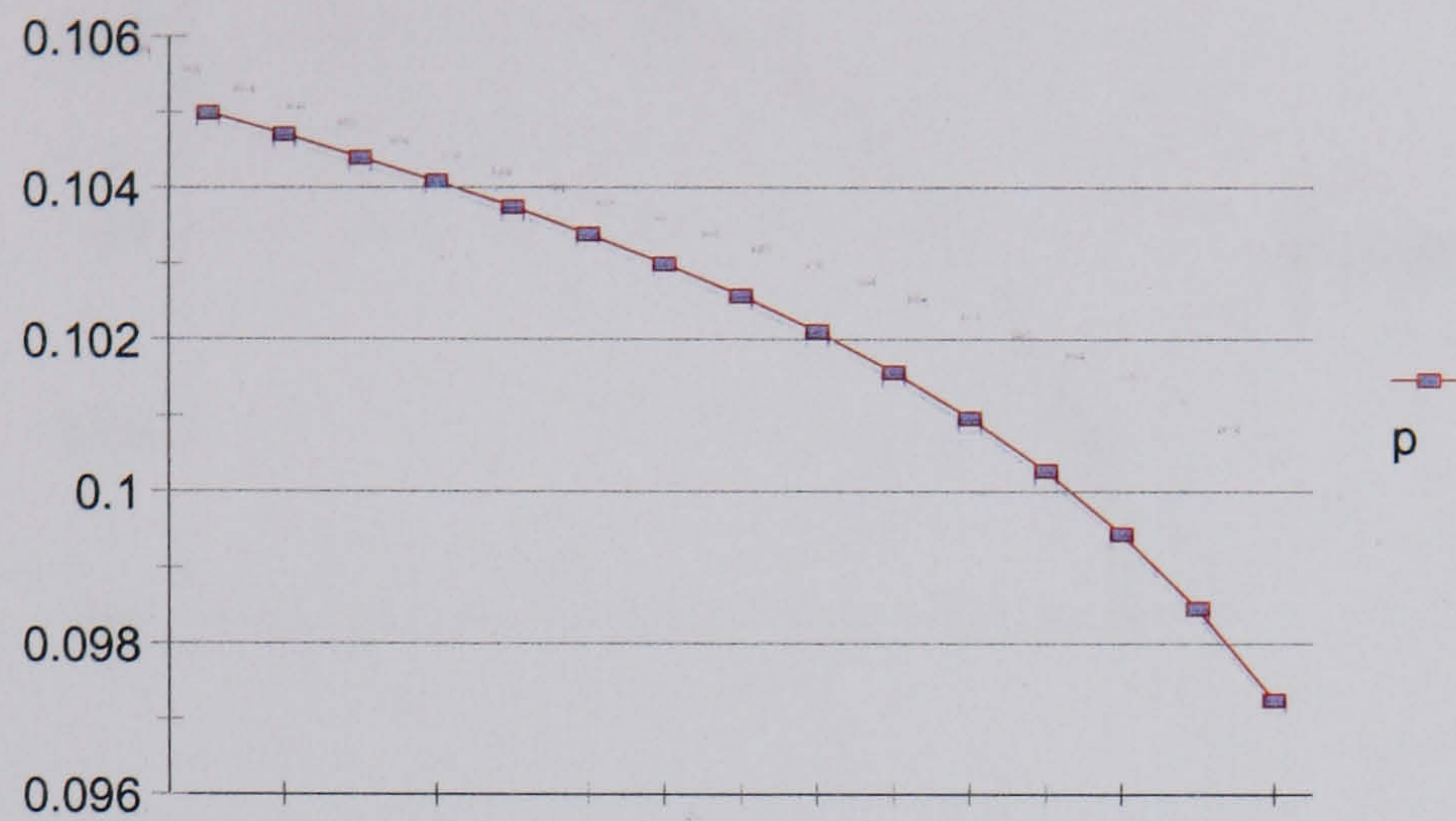
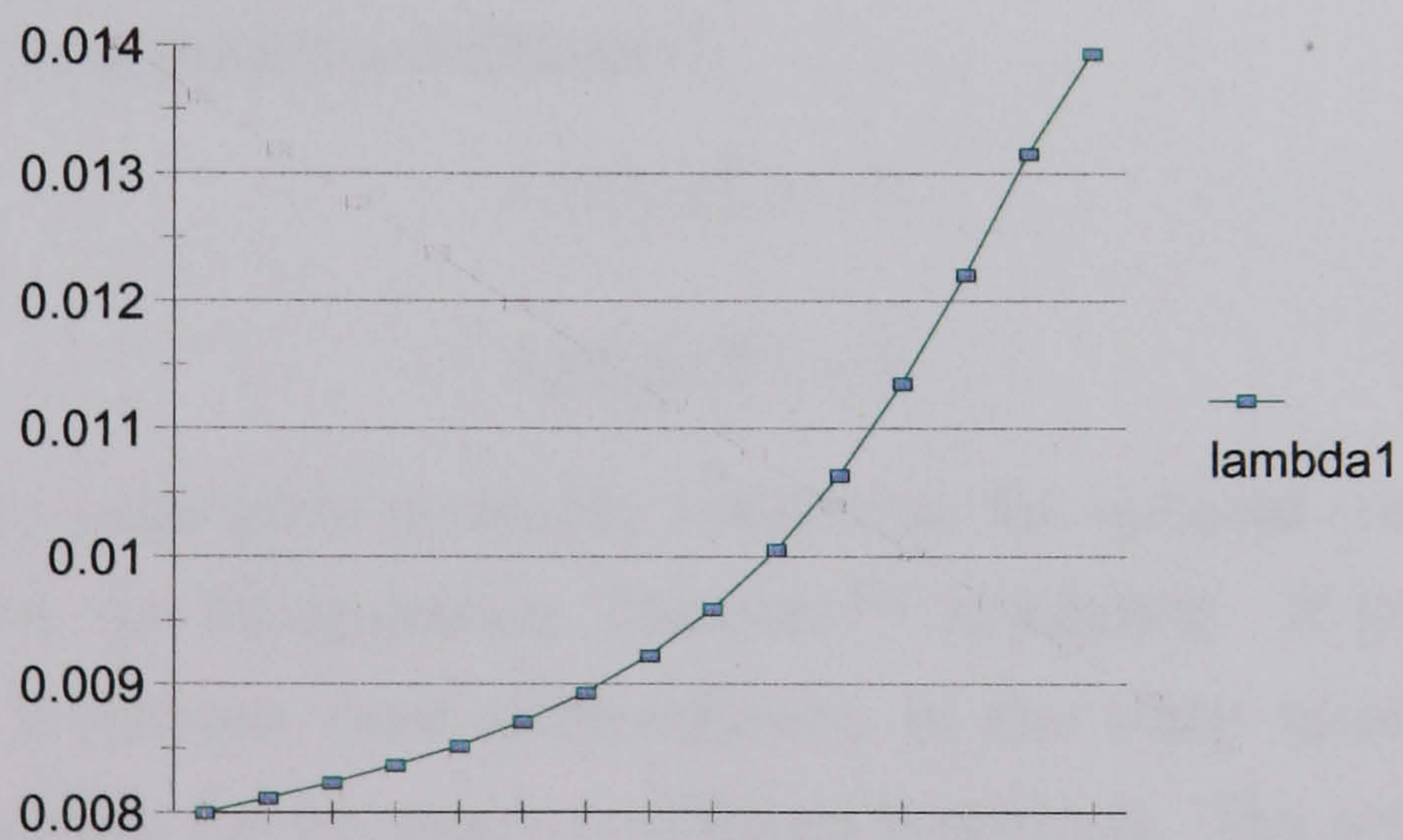

Figure 24: Time behaviour of  $p$  for  $p(0) = 0.105$





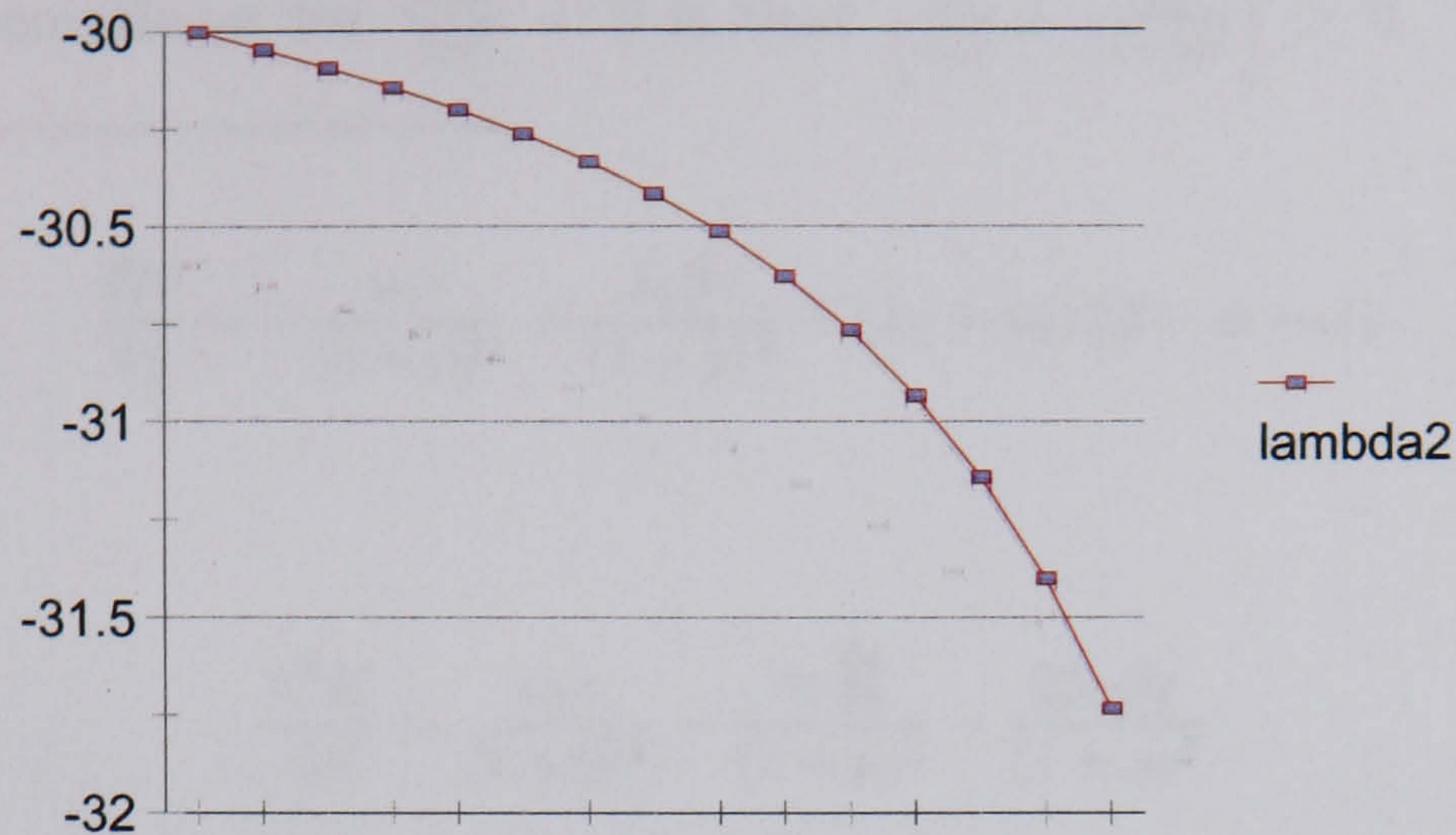

Figure 26: Time behaviour of  $\lambda_2$  for  $\lambda_2(0) = -30$

calculations are given in Appendix A.4.

Next we allow for the demographic-epidemiological parameters being a function of the capital per healthy worker ratio,  $z$ . First we consider the case with a finite time horizon and nonnegative terminal constraints on the state variables. Specifically, for (119) the necessary conditions for optimality include the transversality conditions<sup>211</sup>

$$\lambda_1(T)z(T) = 0 \quad (163)$$

$$\lambda_2(T)p(T) = 0 \quad (164)$$

The maximum principle's necessary conditions for optimal control are also sufficient when the Mangasarian Theorem<sup>212</sup> is fulfilled. If the maximised Hamiltonian is concave (and differentiable) in the state variables  $p$  and  $z$  any path satisfying the necessary conditions is optimal. The concavity of the maximised Hamiltonian requires<sup>213</sup>

$$\frac{\delta^2 H^*}{\delta p^2} = -\frac{\lambda_1}{(1+p)} \left[ \frac{u_1}{u_{11}} + \frac{2z\beta}{(1+p)^2} \right] < 0 \quad (165)$$

<sup>211</sup>Leonard and Long, 1992.

<sup>212</sup>Chiang, 1992; Mangasarian, 1966.

<sup>213</sup>From (135)



A sufficient condition for  $\frac{\delta^2 H^*}{\delta p^2} < 0$  is that  $\left[ \frac{u_1}{u_{11}} + \frac{2z\beta}{(1+p)^2} \right] > 0$ . Furthermore,

---

$$\frac{\delta H}{\delta p} = -\frac{u_1 c}{(1+p)^2} + \frac{\lambda_1 \beta z}{(1+p)^2} + (\lambda_2 + u_2)(\beta - \alpha - \omega) \quad (\text{f38})$$

we have

$$\frac{\delta^2 H}{\delta p^2} = \frac{u_1 c}{(1+p)^3} - \frac{u_1 \frac{\delta c}{\delta p}}{(1+p)^2} - \frac{2\lambda_1 \beta z}{(1+p)^3} \quad (\text{f39})$$

with

$$\frac{\delta c}{\delta p} = \frac{\lambda_1(1+p)}{u_{11}} + \frac{c}{(1+p)} \quad (\text{f40})$$

so that (f40) becomes

$$\frac{u_1 c}{(1+p)^3} - \frac{u_1}{(1+p)^2} \left[ \frac{\lambda_1(1+p)}{u_{11}} + \frac{c}{(1+p)} \right] - \frac{2\lambda_1 \beta z}{(1+p)^3} \quad (\text{f41})$$

or

$$\frac{u_1 c}{(1+p)^3} - \frac{u_1 \lambda_1}{u_{11}(1+p)} - \frac{u_1 c}{(1+p)^3} - \frac{2\lambda_1 \beta z}{(1+p)^3} \quad (\text{f42})$$

and eventually

$$-\frac{\lambda_1}{(1+p)} \left[ \frac{u_1}{u_{11}} + \frac{2z\beta}{(1+p)^2} \right] \quad (\text{f43})$$



we need<sup>214</sup>

$$\begin{aligned} \frac{\delta^2 H^*}{\delta z^2} = & \lambda_1 \left[ f'' - z \left( \alpha'' - \beta'' \frac{p}{(1+p)} \right) - 2 \left( \alpha' - \beta' \frac{p}{(1+p)} \right) \right] \\ & + (\lambda_2 + u_2) [(\beta'' - \alpha'' - \omega'') p] \\ & + u_{22} [(\beta' - \alpha' - \omega')^2 p^2] < 0 \end{aligned} \quad (166)$$

which is negative if  $\lambda_2(t) < 0$  and  $(\beta'' - \alpha'' - \omega'') \geq 0$ . Theoretically there is nothing to constrain the sign of  $\lambda_2(t)$ . However, as  $\lambda_2(t)$  is the shadow price of a marginal increase in the TB prevalence of the disease, we expect  $\lambda_2(t)$  to be negative. A further condition to be satisfied is

---

<sup>214</sup>From (134)

$$\begin{aligned} \frac{\delta H}{\delta z} = & \lambda_1 \{ f' - \phi - [\alpha - \beta p / (1+p)] - z [\alpha' - \beta' p / (1+p)] \} \\ & + (\lambda_2 + u_2) (\beta' - \alpha' - \omega') p \end{aligned} \quad (f44)$$

we have

$$\begin{aligned} \frac{\delta^2 H}{\delta z^2} = & \lambda_1 \{ f'' - 2 [\alpha' - \beta' p / (1+p)] - z [\alpha'' - \beta'' p / (1+p)] \} \\ & + (\lambda_2 + u_2) (\beta'' - \alpha'' - \omega'') p + u_{22} (\beta' - \alpha' - \omega') p \frac{\delta \dot{p}}{\delta p} \end{aligned} \quad (f45)$$

where

$$\frac{\delta \dot{p}}{\delta p} = (\beta' - \alpha' - \omega') p \quad (f46)$$

so that (166) becomes

$$\begin{aligned} \frac{\delta^2 H}{\delta z^2} = & \lambda_1 \{ f'' - 2 [\alpha' - \beta' p / (1+p)] - z [\alpha'' - \beta'' p / (1+p)] \} \\ & + (\lambda_2 + u_2) (\beta'' - \alpha'' - \omega'') p + u_{22} (\beta' - \alpha' - \omega')^2 p^2 \end{aligned} \quad (f47)$$



$$\left(\frac{\delta^2 H^*}{\delta p^2}\right) \left(\frac{\delta^2 H^*}{\delta z^2}\right) - \left(\frac{\delta^2 H^*}{\delta p \delta z}\right) > 0 \quad (167)$$

where<sup>215</sup>

$$\frac{\delta^2 H^*}{\delta p \delta z} = \frac{\lambda_1}{(1+p)^2} (\beta + z\beta') + (\lambda_2 + u_2) (\beta' - \alpha' - \omega') \quad (168)$$

Given the intractability of imposing these conditions globally we choose to check conditions (165)-(166)-(167) numerically on the solution paths. With initial conditions

$$[p(0) = 0.1, z(0) = 10, \lambda_1(0) = 0.08, \lambda_2(0) = -30] \quad (169)$$

the sufficient conditions for concavity are fulfilled for any finite horizon optimal path. Specifically, for (169), the conditions (165), (166) and (167) are satisfied with  $\frac{\delta^2 H^*}{\delta p \delta z} < 0$ . Furthermore, as illustrated in Fig. 27, the deterministic path initially has a higher level of per period utility than the optimal path. However, by  $t = 20$  the optimal path overtakes the deterministic path. We can interpret this as evidence in favour of a short term high level

---

<sup>215</sup>From (135)

$$\frac{\delta H}{\delta p} = -\frac{u_1 c}{(1+p)^2} + \frac{\lambda_1 \beta z}{(1+p)^2} + (\lambda_2 + u_2) (\beta - \alpha - \omega) \quad (f48)$$

we have that

$$\frac{\delta^2 H}{\delta p \delta z} = +\frac{\lambda_1 \beta}{(1+p)^2} \frac{\lambda_1 \beta' z}{(1+p)^2} + (\lambda_2 + u_2) (\beta' - \alpha' - \omega') \quad (f49)$$

or

$$\frac{\delta^2 H}{\delta p \delta z} = \frac{\lambda_1}{(1+p)^2} (\beta + \beta' z) + (\lambda_2 + u_2) (\beta' - \alpha' - \omega') \quad (f50)$$



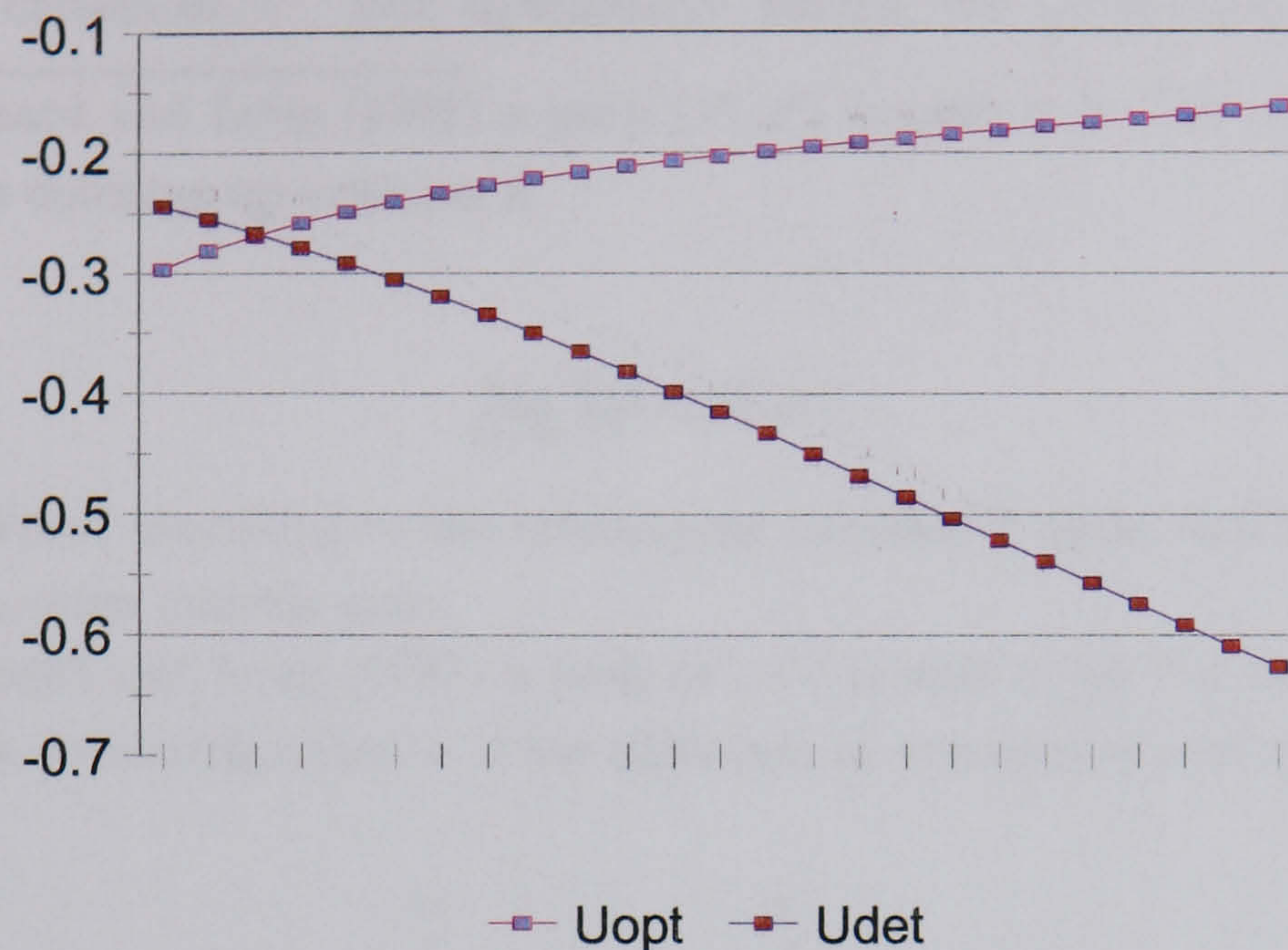

Figure 27: Per period utility on the deterministic and optimal paths

of savings to increase the capital per healthy worker which reduces the TB transmission coefficient ( $\beta$ ) and the total death rate of the infected class ( $\omega$ ) and to increase the net growth population rate of the susceptible individuals ( $\alpha$ ) leading to a reduction in the TB prevalence. Moreover, the integral of period utility is higher on the optimal path as indeed it must be.

If the time horizon is infinite, then the transversality conditions are not generally necessary. However, an adaptation of a similar sufficiency theorem<sup>216</sup> is used here. Specifically, if a form of transversality condition holds

$$\lim_{T \rightarrow \infty} [\lambda_1(T)z(T) + \lambda_2(T)p(T)] \leq 0 \quad (170)$$

and the maximized Hamiltonian is concave in the state variables  $p$  and  $z$  then any path satisfying the necessary conditions is optimal according to the

<sup>216</sup>Theorem 9.3.1 in Leonard and Long, (1992).



catching-up criterion.<sup>217</sup> For optimality under the overtaking criterion,<sup>218</sup>

<sup>217</sup>As in Leonard and Long (1992) a path  $(s^*, c^*)$  is said to be "no worse" than path  $(s, c)$  under the catching-up criterion if

$$\lim_{t \rightarrow \infty} [\inf z(t)] \geq 0 \quad (\text{f51})$$

A path is optimal according to the catching-up criterion if under that criterion it is no worse than any other feasible path.

<sup>218</sup>As in Leonard and Long (1992) a path  $(s^*, c^*)$  is said to be "no worse" than path  $(s, c)$  under the overtaking criterion if the difference in cumulative performances

$$z(t) \equiv \int_0^t v(s^*, c^*, \tau) - \int_0^t v(s, c, \tau) d\tau \quad (\text{f52})$$

is nonnegative for all  $t$  sufficiently large. A path is optimal according to the overtaking criterion if under that criterion it is no worse than any other feasible path. Furthermore, the overtaking criterion and the catching-up criterion are both equivalent to the maximisation optimality criteria. Generally, when dealing with the problem of finding the control vector  $C(t)$  that maximises the integral

$$\int_0^{\infty} v(S(t), C(t), t) dt \quad (\text{f53})$$

subject to

$$\dot{S}_i = f^i(S(t), C(t), t) \quad \text{for } i = 1, 2, \dots, n \quad (\text{f54})$$

$$g^j(S(t), C(t), t) \geq 0 \quad \text{for } j = 1, 2, \dots, m' \quad (\text{f55})$$

$$g^h(S(t), C(t), t) \geq 0 \quad \text{for } h = m' + 1, 2, \dots, m \quad (\text{f56})$$

$$s_i(0) = s_{i0} \quad \text{for } i = 1, 2, \dots, n \quad (\text{f57})$$

if the integral does not converge, optimality can be defined by referring to the overtaking criterion or the catching-up criterion. It can be shown that all the necessary conditions



(170) needs to be modified into a more strict condition

$$[\lambda_1(T)z(T) + \lambda_2(T)p(T)] = 0 \quad (171)$$

#### 4.4 Summary

For a homogenous mixing population composed of susceptible individuals ( $x(t)$ ) who, if and when TB infected, immediately become infectious ( $y(t)$ ), we find that the demographic-epidemiological system has no stationary point or steady state. Depending on whether the infection rate is greater or less than the sum of the net growth rate of the susceptible individuals and the total death rate of the TB infected people, as  $t$  tends to infinity, the TB prevalence either rises exponentially or approaches zero so that the disease is eradicated. The calibration results, using data from the Western Pacific Region and the East Mediterranean Region confirm the analytical results. Specifically, in areas where improved living standards and the availability of effectively used antibiotics have reduced the risk of the TB transmission as in the Western Pacific Region, the TB prevalence decreases tending to zero as  $t$  tends to infinity. However, in areas like East Mediterranean Region, characterised by overcrowded, poor living and working conditions and lack of access to treatment, the probability of TB transmission increases and favours the rapid spread of the disease.

When dealing with an economic-epidemiological growth model with a production function of capital stock per healthy worker in which the demographic-epidemiological parameters are controlled by the level of economic prosperity (i.e. capital per healthy worker), we find that the dy-

---

for finite-horizon problems are also necessary for the infinite-horizon problems (Leonard and Long, 1992) with the exception of the transversality conditions. Although Seierstad (1998), Benveniste and Scheinkman (1982) and Michel (1982) obtained the appropriate transversality conditions, some of the restrictions required for the transversality conditions to hold are too strict to be applicable to most problems of economic interest. Therefore, sufficiency theorem are used to identify optimal paths.



namics of the economic-epidemiological system is characterized by multiple equilibria: two stationary points involve zero productive capital and replicate the basic predator-prey Lotka-Volterra type equilibrium points while the third stationary state is an economic-epidemiological equilibrium in which the economy and the disease coexist. As TB is partially a function of the general level of prosperity, it is possible to determine the conditions, expressed in terms of demographic-epidemiological parameters (functions of the capital per healthy worker) for which economic growth can drive the TB prevalence towards zero. Specifically, we find that growth does have an impact but it is unlikely itself to eliminate the disease unless it has a sufficiently strong effect on the infection rate. Overall, the impact of adding the economic dimension to the demographic-epidemiological process leads to a system characterised by balanced growth paths. Specifically, the system settles down either to an economic-epidemiological steady state with a positive level of economic prosperity and a constant population structure of susceptible and TB infected people or at an equilibrium point where via economic prosperity the disease has been eradicated. For our calibration, by selecting data from the Region of Americas and the South-East Asia Region as representative of high and low capital countries, respectively and by choosing two alternative values for the savings rate we reproduce both the alternative outcomes. Our results indicate the crucial role of savings in allowing sustainability of the population and control of the disease. Without any capital per healthy worker at all the calibrated demographic-epidemiological parameters are such that TB prevalence tends to infinity and the total population would asymptotically be driven to extinction. With a positive initial amount of capital per healthy worker but a low savings rate the system approaches a steady state in which the TB infected, the healthy individuals and capital stock are all present and growing at a common rate. However, the approach to this steady state is cyclical in both the TB prevalence and the prosperity of the economy. For the case when the savings rate is relatively high, even a small amount of capital per healthy worker is sufficient to eliminate the disease in the long run. In the



transition to the steady state there are generally cycles in economic prosperity and there may be also cycles in TB prevalence for sufficiently low levels of capital per healthy worker. The steady state is akin to that of a Solow-Swan model in which the growth rate of the healthy worker is endogenous.

Next we consider optimal dynamic policy where the savings rate is selected to optimise an intertemporal welfare function which depends on the population structure and on consumption per capita. The global dynamics of this model is characterised by two steady states each of which is a four dimensional saddle point. Using data from the Region of Americas and the South East Asia Region we are able to replicate only the steady state where the TB prevalence is zero, the productive capital level and its shadow price are positive and the shadow value of TB prevalence is negative. The orders of magnitude suggest that the steady state is characterised by a high capital worker ratio and by absence of the disease. On dynamic paths around the steady state, the capital labour ratio varies much more rapidly than TB prevalence although, in terms of the costate variables the shadow price of prevalence shows much more volatility than the shadow price of capital. On the optimal path, when below the steady state, consumption per capita rises with fairly heavy capital accumulation in order to improve the demographics. It is worthwhile to mention that, theoretically, another steady state where TB prevalence settles at a positive constant level exists.

In the next Chapter, we allow for TB infected individuals to receive effective treatment and to be cured. At first only the demographic-epidemiological dynamics is analysed. Subsequently, we model the interaction between the economy and the demographic-epidemiological system by considering demographic-epidemiological factors to be functions of public health investment. Within this economic-epidemiological framework both the case with and without recovery are considered. Finally, we examine the case of a central planner facing a TB epidemic with the possibility of providing TB effective treatment who chooses his actions so that the division of output between consumption and public health investment is set to maximise social welfare.



## 5 Descriptive and Optimal Control Analysis of a Public Health Investment Model with and without Recovery

This chapter develops a model for the dynamic analysis of the spread of TB where the possibility for TB infected individuals to receive treatment and to be cured is explored. Targeted public health intervention, such as Direct Observed Therapy Strategy (DOTS), and isolation of TB infected people are the currently available international strategies for controlling the recent TB epidemic. However, empirical evidence suggests that these TB control strategies are not widely spread<sup>219</sup> or are unable to sustain high cure rates.<sup>220</sup> One of the problems in targeted bio-medical strategies (i.e. DOTS) implementation is poor compliance. The main reasons for lack of compliance among patients known to have TB were lack of operation or infrastructure of public health services. These partially treated patients remain a continuous source of TB infection and could also potentially promote the emergence of MDR-TB.<sup>221</sup> Empirical evidence suggests that public health interventions may favour the decline of TB morbidity and mortality by enhancing the proportion of patients who complete therapy.<sup>222</sup> Improvements in the basic health infrastructure (e.g. hospital, medical equipment, transport and supplies) to support the implementation of DOTS are shown to enhance the compliance rate and, consequently, the probability for an individual to complete the TB treatment and to be eventually cured.<sup>223</sup>

---

<sup>219</sup>Only 10 per cent of the world's TB patients are estimated to have access to DOTS according to Ginsberg (1998) or 32 per cent according to Netto et al., 1999.

<sup>220</sup>Alvi et al., 1998; Bloch et al., 1996; Dievler, 1997; Fairchild and Oppenheimer, 1998; Ginsberg, 1998; Gittler, 1994; Hurtig et al., 1999; Jaramillo, 1999; Netto et al., 1999; Porter and McAdam, 1994; Sumartojo, 1993; Wallace and Wallace, 1997.

<sup>221</sup>See Section 2.2.1.

<sup>222</sup>Alvi et al., 1998; Bloch et al., 1996; Center for Disease Control, 1989, 1992; Fairchild and Oppenheimer, 1998; Gittler, 1994; Sumartojo, 1993.

<sup>223</sup>Addington, 1979; Alvi et al., 1998; Brudney and Dobkin, 1991; Centers for Disease Control, 1989, 1991; Fox, 1962; Gittler, 1994; Hopewell et al., 1988; Institute of Medicine,



In what follows TB preventive care is also considered. Public health investment as improvements of screening in high risk areas/institutions or drug therapy<sup>224</sup> for latent TB infected individuals, enhance the probability of rendering the patient noninfectious, thereby protecting others from becoming infected due to contact with the infected patient.

The work is outlined as follows: Section 5.1 sets out an demographic-epidemiological model of population dynamics in the presence of TB infectious disease with the possibility of recovering from the TB infection. Section 5.2 develops an economic-epidemiological dynamic model where demographic and epidemiological parameters (the net population growth rate of the susceptible individuals, the TB transmission rate, the total death rate of the infected people and the recovery rate) are functions of specific public health infrastructure investment. A descriptive analysis of TB dynamic without recovery is considered in Section 5.3. Section 5.4 discusses the implications of our analysis for public health infrastructure investment to limit the spread of TB infectious disease. In each section we present analytic results, followed by results from a calibrated version of the model using realistic estimates of the demographic, epidemiological and economic parameters.

## 5.1 Descriptive Analysis: Demographic - Epidemiological Model

We analyse a homogeneously mixing population composed of  $N(t)$  individuals in a given area at time  $t$  ( $t \geq 0$ ), who are either susceptible ( $x(t)$ ) or TB infected/infectious ( $y(t)$ ). When susceptible, an individual can either become infected or remain susceptible. Once infected, an individual can either remain infected, die because of TB or causes other than TB, or be cured. As

---

1992; Reichman, 1991; Sumartojo, 1993; Twumasi, 1996;.

<sup>224</sup>Drug therapy, based on isoniazid prescription for 12 months, has been proved to be effective in treatment of individuals with latent TB infection to prevent their development of clinically active TB. Center for Disease Control, 1989, 1990, 1991, 1992, 1993; Gittler, 1994; Sumartojo, 1993; Tulsy et al., 1998.



recovery from TB does not grant full immunity, when an infected individual is cured is assumed to rejoin the class of the susceptible individuals. Individuals continuously meet one another over time. The degree to which the population's behaviour responds to an increase/decrease in TB prevalence (e.g. wearing protective mask, avoiding high risk areas) is not considered here.<sup>225</sup> This gives

$$\begin{cases} \dot{x}(t) = \alpha x(t) - \frac{\beta x(t) y(t)}{(x(t)+y(t))} + \rho y(t) \\ \dot{y}(t) = \frac{\beta x(t) y(t)}{(x(t)+y(t))} - \omega y(t) - \rho y(t) \end{cases} \quad (172)$$

As in the previous chapters, initially, the demographic-epidemiological parameters are exogenously determined and constant (with  $\alpha$ ,  $\beta$ ,  $\omega$  and  $\rho > 0$ ). Specifically, the net susceptible population growth rate of the susceptible class,  $\alpha$ , represents the difference between the susceptible birth rate and the susceptible death rate. The TB transmission coefficient,  $\beta$ , represents the probability of infection from a meeting between a TB infected/infectious individual and a susceptible person. The total death rate of the infected individuals,  $\omega$ , is given by the sum of the TB related death rate and the death rate for causes other than TB of the TB infected individuals. The possibility of recovery from TB is here represented by  $\rho$ , the probability of a TB infected individual to receive full treatment and to be completely cured.

The transmission dynamic of TB is analysed by referring to the theory of nonlinear dynamical systems. It can be shown that the system has no stationary points.<sup>226</sup> Next we want to examine whether the system (172)

---

<sup>225</sup>Philipson, 1995.

<sup>226</sup>From (172) we know that any stationary point would require

$$\alpha x(t) = \omega y(t) \quad (f58)$$

Using (f58) in (172) gives

$$\dot{x}(t) = \dot{y}(t) = 0 \quad (f59)$$



exhibits one or more steady states. Define  $p(t) = \frac{y(t)}{x(t)}$  to be the TB prevalence

---

only if

$$(\omega + \alpha)(\omega + \rho) = \beta\omega \tag{f60}$$

For any other parameters combination no stationary point exists.



rate and rewrite the dynamic system (172) in terms of just  $p(t)$  and  $x(t)$  as<sup>227</sup>

---

<sup>227</sup>From (172) we know

$$\frac{\dot{x}(t)}{x(t)} = \alpha \frac{x(t)}{x(t)} - \frac{\beta x(t) y(t)}{\frac{x(t)+y(t)}{x(t)}} + \rho \frac{y(t)}{x(t)} \quad (\text{f61})$$

or

$$\frac{\dot{x}(t)}{x(t)} = \alpha - \frac{\beta y(t)}{1 + \frac{y(t)}{x(t)}} + \rho \frac{y(t)}{x(t)} \quad (\text{f62})$$

By setting  $p(t) = \frac{y(t)}{x(t)}$ , we can re-write (f62) as

$$\frac{\dot{x}(t)}{x(t)} = \alpha - \frac{\beta p(t)}{1 + p(t)} + \rho p(t) \quad (\text{f63})$$

Furthermore, as

$$\frac{\delta \left( \frac{y(t)}{x(t)} \right)}{\delta t} = \frac{\dot{y}(t)}{x(t)} - y(t) \frac{\dot{x}(t)}{x^2(t)} \quad (\text{f64})$$

from (172) we know that

$$\frac{\delta \left( \frac{y(t)}{x(t)} \right)}{\delta t} = \frac{\beta x(t) y(t)}{\frac{x(t)+y(t)}{x(t)}} - \omega \frac{y(t)}{x(t)} - \rho \frac{y(t)}{x(t)} - \frac{y(t)}{x(t)} \left( \alpha - \frac{\beta p(t)}{1 + p(t)} + \rho p(t) \right) \quad (\text{f65})$$

or recalling that  $p(t) = \frac{y(t)}{x(t)}$

$$\dot{p}(t) = \frac{\beta p(t)}{1 + p(t)} - \omega p(t) - \rho p(t) - p(t) \left( \alpha - \beta \frac{p(t)}{1 + p(t)} + \rho p(t) \right) \quad (\text{f66})$$

or

$$\dot{p}(t) = \beta \frac{p(t)}{1 + p(t)} - \omega p(t) - \rho p(t) - \alpha p(t) - \beta \frac{p^2(t)}{1 + p(t)} - \rho p^2(t) \quad (\text{f67})$$

$$\dot{p}(t) = (\beta - \alpha - \omega - \rho) p(t) - \rho p^2(t) \quad (\text{f68})$$



$$\begin{cases} \dot{p}(t) = (\beta - \alpha - \omega - \rho)p(t) - \rho p(t)^2 \\ \frac{\dot{x}(t)}{x(t)} = \alpha - \frac{\beta p(t)}{(1+p(t))} + \rho p(t) \end{cases} \quad (173)$$

From (172) we have

$$\dot{x}(t) = \left[ \alpha - \frac{\beta p}{(1+p)} + \rho p \right] x(t) \quad (174)$$

$$\dot{y}(t) = \left[ \frac{\beta}{(1+p)} - (\omega + \rho) \right] y(t) \quad (175)$$

For a steady state to exist we require  $\varphi = \frac{\dot{x}(t)}{x(t)} = \frac{\dot{y}(t)}{y(t)}$ . From (173) we know that  $(\beta - \alpha - \omega - \rho)/\rho$  is the nonzero solution for  $p$  in the  $\dot{p}$  equation. As only nonnegative TB prevalence values ( $p \geq 0$ ) are acceptable, we require  $(\beta - \alpha - \omega - \rho) \geq 0$ . Furthermore, it can be easily shown<sup>228</sup> that the rate of growth is given by

$$\varphi = \frac{(\omega + \alpha)(\omega + \rho) - \beta\omega}{(\beta - \alpha - \omega)} \quad (176)$$

---

<sup>228</sup>From (174) and (175) we know that

$$\varphi = \frac{\dot{x}(t)}{x(t)} = \frac{\left[ \alpha - \frac{\beta p}{(1+p)} + \rho p \right] x(t)}{x(t)} = \left[ \alpha - \frac{\beta p}{(1+p)} + \rho p \right] \quad (f69)$$

and

$$\varphi = \frac{\dot{y}(t)}{y(t)} = \frac{\left[ \frac{\beta}{(1+p)} - (\omega + \rho) \right] y(t)}{y(t)} = \left[ \frac{\beta p}{(1+p)} - (\omega + \rho) \right] \quad (f70)$$

respectively. Recalling that the nonzero solution to the  $\dot{p}$  equation in (173) is  $p^* = (\beta - \alpha - \omega - \rho)/\rho$ , the expression for  $\varphi$  in (f69) and (f70) can be concisely rewritten as

$$\varphi = \frac{(\omega + \alpha)(\omega + \rho) - \beta\omega}{(\beta - \alpha - \omega)} \quad (f71)$$

If  $\varphi$  and  $p^*$  are both positive then there is a positive balance growth. However, for  $\varphi < 0$  and  $p^* > 0$  the balanced growth is negative. If  $p^* < 0$  there is no balance growth path.



It follows that, in order to have a balanced growth path along which  $x(t)$  and  $y(t)$  each grow at a positive rate<sup>229</sup>, the numerator in (176) needs to be positive  $((\omega + \alpha)(\omega + \rho) - \beta\omega > 0)$ . When  $(\omega + \alpha)(\omega + \rho) - \beta\omega < 0$  the system exhibits a negative balanced growth path ( $\varphi < 0$ ).

Specifically, as in Fig. 28a, for  $(\beta - \alpha - \omega - \rho) > 0$  and  $(\omega + \alpha)(\omega + \rho) - \beta\omega < 0$ , when the initial condition is above  $p(0) = (\beta - \alpha - \omega - \rho)/\rho$ , at first, both the number of TB infected individuals and the number of susceptible people increase. The number of infected people increases at a slower rate than the susceptible people. Subsequently, both the number of TB infected individuals and the number of susceptible people decrease with the number of infected people falling at a faster rate than the susceptible people. When the initial conditions are below  $p(0) = (\beta - \alpha - \omega - \rho)/\rho$ , at first, both the number of TB infected individuals and the number of susceptible people increase with the number of infected people increasing at a faster rate than the susceptible people. Subsequently, both the number of TB infected individuals and the number of susceptible people decrease with the number of infected people falling at a slower rate than the susceptible people. Overall, the system population is led towards extinction. This case finds empirical support in examples where the clinical TB cure rate for segregated groups of TB actively infected individuals has been found to be far lower than expected with more than half of the treated patients dead five years after discharge. Close proximity of active TB infected people associated with often inadequate care facilities led to decimation of the segregated infected population.<sup>230</sup> Here, at first,  $\frac{\dot{y}(t)}{y(t)}$  decreases (requiring  $\frac{\beta}{(1+p)} - (\omega + \rho) < 0$ ) and then increases (requiring  $\frac{\beta}{(1+p)} - (\omega + \rho) > 0$ )

In the case with  $(\beta - \alpha - \omega - \rho) > 0$ ,  $(\omega + \alpha)(\omega + \rho) - \beta\omega > 0$  and  $p(0) < (\beta - \alpha - \omega - \rho)/\rho$ , as illustrated in Fig. 28b, at first, both the number of TB infected individuals and the number of susceptible people decrease. Subsequently, both the number of TB infected individuals and the number

---

<sup>229</sup>Here  $(\beta - \alpha - \omega)$  is assumed to be positive.

<sup>230</sup>Bryder, 1988.



of susceptible people increase with the number of infected people increasing at a faster rate than the susceptible people. When  $p(0) > (\beta - \alpha - \omega - \rho)/\rho$ , at first, both the number of susceptible people and the number of TB infected individuals decrease with the number of infected people decreasing at a faster rate than the susceptible people. Subsequently, the number of susceptible people decreases and the number of infected individuals increases. In both cases a TB epidemic occurs. This extreme population dynamic is found to be consistent with contemporary evidence where TB epidemics, after an initial reduction during the 1970s, reappeared particularly in specific areas or cities (highly density populated areas, homeless shelters, correctional institutions, school and office buildings or among US minority urban communities) both in developing and developed countries.<sup>231</sup>

When  $(\beta - \alpha - \omega - \rho) < 0$  the system does not have a balanced growth path. Here, as shown in Fig. 28c, TB prevalence decreases and asymptotically approaches zero as  $t \rightarrow \infty$  (however, in any finite time, TB is still present in an endemic form). This can be seen in the expression representing the changes in the TB prevalence level

$$\frac{\dot{p}(t)}{p(t)} = (\beta - \alpha - \omega - \rho) - \rho p(t) \quad (177)$$

where  $(\beta - \alpha - \omega - \rho)$  is known to be negative and  $\rho p(t)$  to be positive.

Empirical evidence of lasting successful TB control can be found in most of the developed countries with exceptions for large cities and pockets of poverty where TB is present in an epidemic form.

### 5.1.1 Calibration

Some general insight about the dynamic properties of the system in (173) can be obtained by calibrating a more detailed realistic specification. To do so we

---

<sup>231</sup>Cronje', 1984; Drucker et al., 1994; Gittler, 1994; Hagan, 1977; Johnston, 1993; McBride, 1991; McNeill, 1992; Mercer, 1990; Santiago, 1991; Szreter, 1988; Wallace, 1990; Wallace et al., 1997; Wilson, 1995.



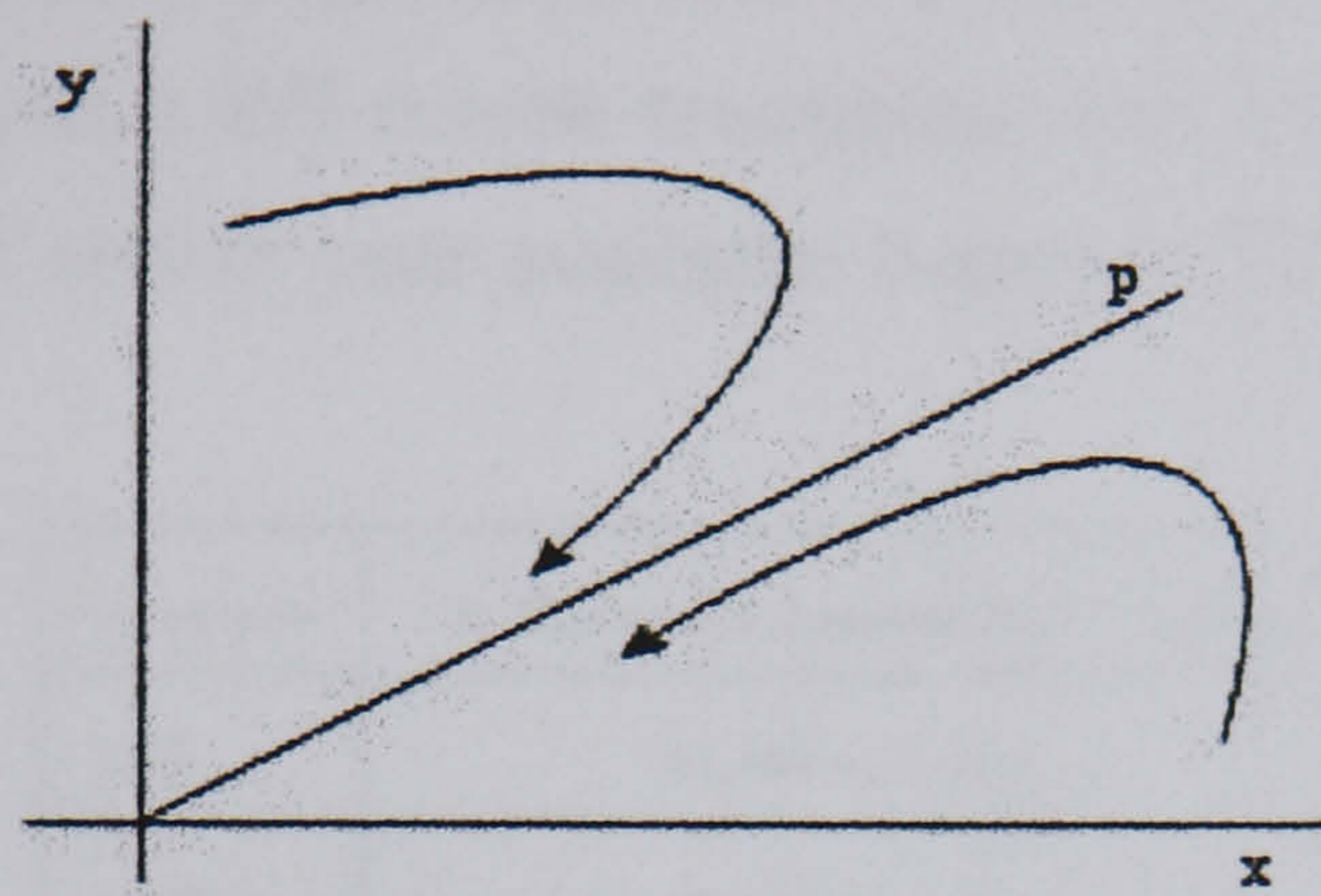

a)

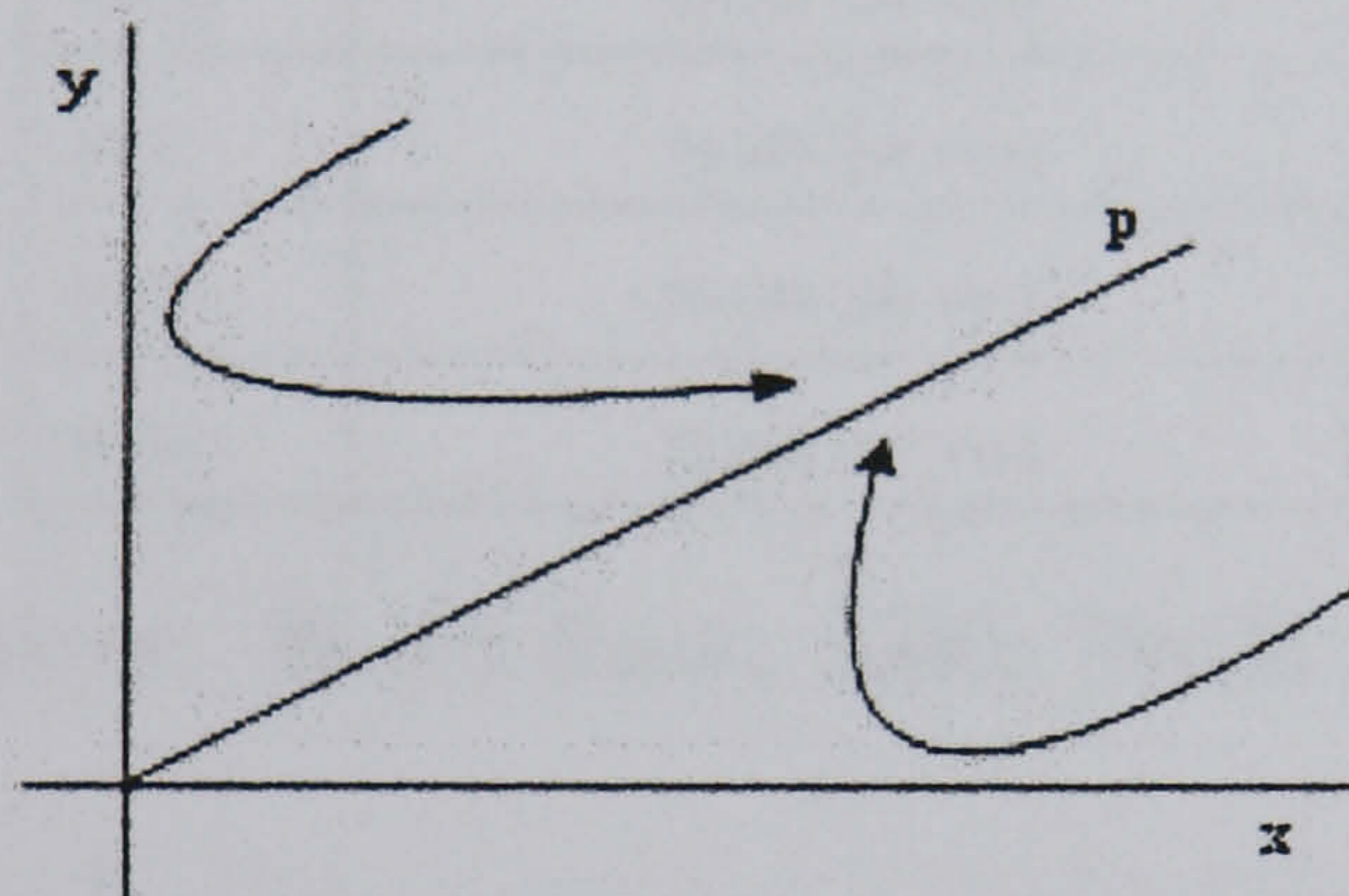

b)

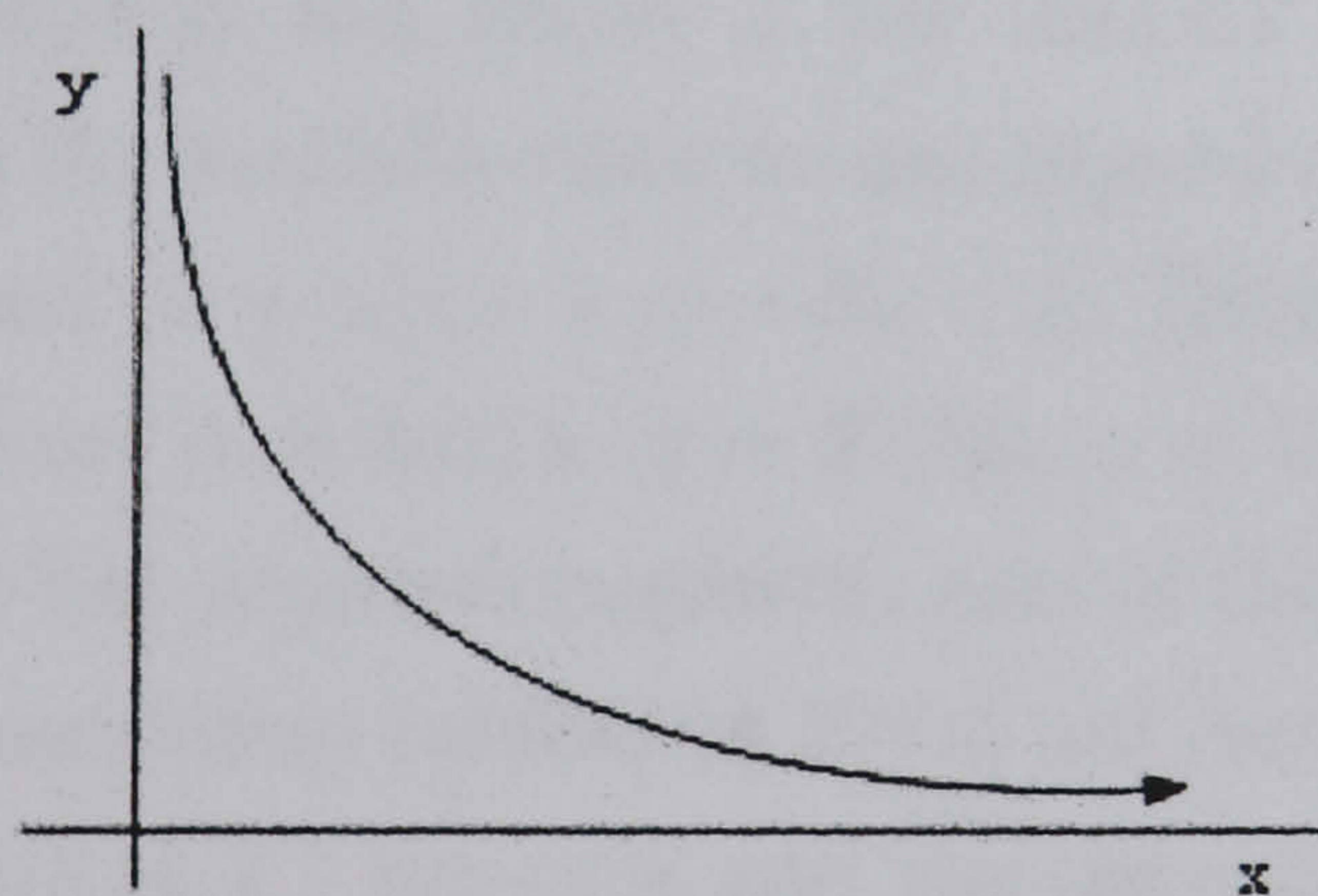

c)

Figure 28: Phase-plane diagram: a) total population extinction,  $(\beta - \alpha - \omega - \rho) > 0$  and  $(\omega + \alpha)(\omega + \rho) - \beta\omega < 0$ ; b) TB epidemic,  $(\beta - \alpha - \omega - \rho) > 0$  and  $(\omega + \alpha)(\omega + \rho) - \beta\omega > 0$ ; c) successful TB control  $(\beta - \alpha - \omega - \rho) < 0$



refer to the data set used in the previous chapter and to data on TB treatment success rate from WB and WHO sources.<sup>232</sup> TB treatment success rate refers to the percentage of new, registered smear-positive (infectious) cases which were cured or in which a full-course treatment was completed. Data (Table 5.1) are for the most recent year available between 1990 and 1997.

Countries	TB Treatment Success Rate 1990-97
AFR	61.433 per cent
AMR	79.143 per cent
SEAR	72.727 per cent
EUR	64.214 per cent
EMR	83.286 per cent
WPR	62.400 per cent

Table 5.1 Source: World Bank, 2000; World Health Organisation, 2000b, d.

TB treatment success rate is highest in East Mediterrean Region and in the Region of Americas and lowest in the African Region and the West Pacific Region. With the available data we can reproduce only the case where  $(\beta - \alpha - \omega - \rho) > 0$  and  $(\omega + \alpha)(\omega + \rho) - \beta\omega < 0$ . Here we use data from the Western Pacific Region:  $\alpha = 0.014$ ,  $\beta = 2.168$ ,  $\omega = 0.037$ ,  $\rho = 0.624$  (with these parameters the net population growth rate of the healthy people is 1.4 per cent, the TB transmission coefficient 216.8 per cent, the total death rate of the infected individual 3.7 per cent and the recovery rate 62.4 per cent). The global phase-plane diagram is in Fig. 29. The balanced decay path TB prevalence is 2.393.

<sup>232</sup>World Bank, 2000; World Health Organization, 2000b, d.



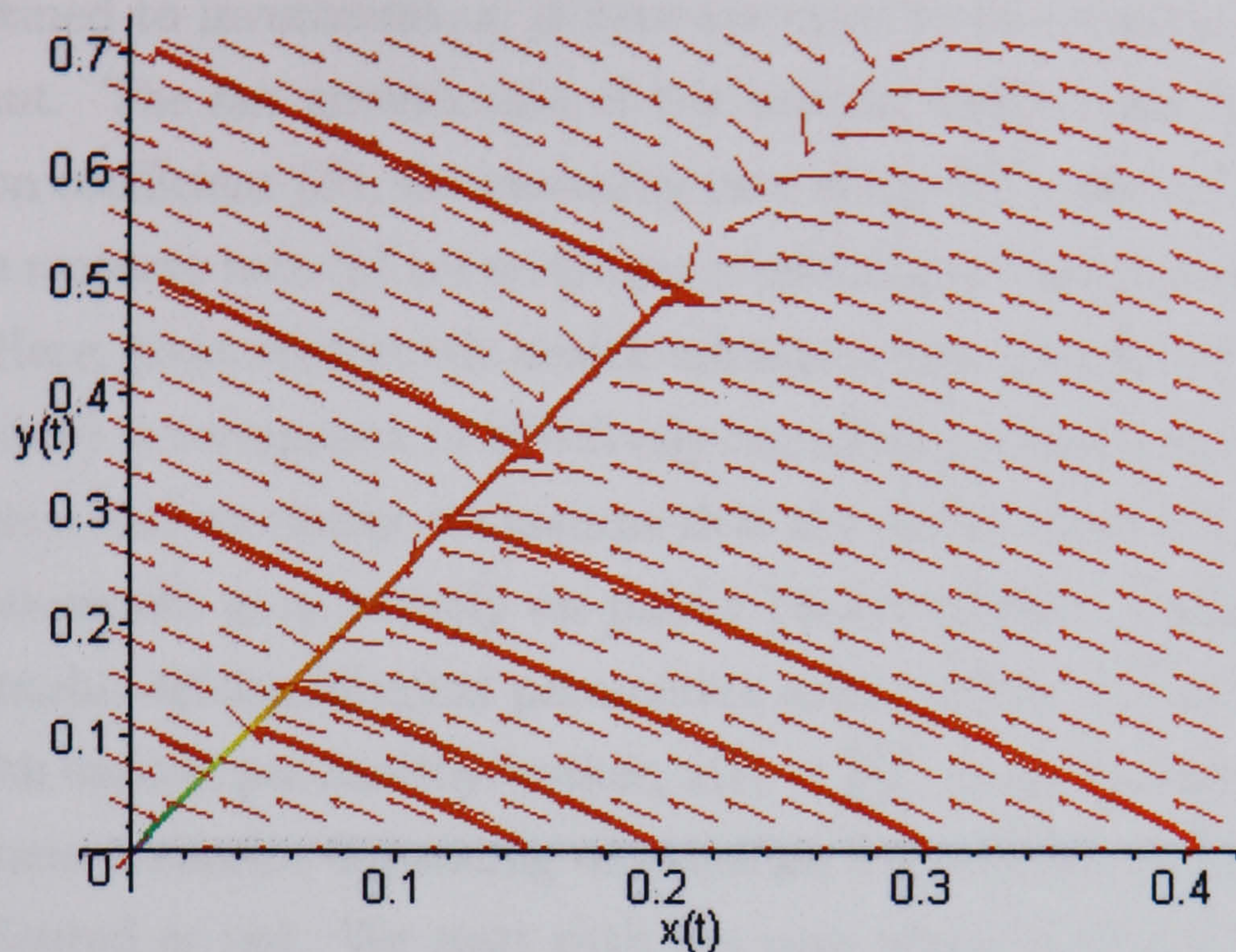

Figure 29: Global phase-plane diagram, demographic-epidemiological model, Western Pacific Region (total population extinction)

## 5.2 Descriptive Analysis: Economic-Epidemiological Model with Recovery

In this section the two-way interaction between demographic-epidemiological factors and economic variables in the dynamic transmission of TB is maintained. As in the previous section, we consider a population of  $N(t)$  individuals where, formally, at each time  $t$ , a given individual can be susceptible,  $x(t)$ , or TB infected and infectious,  $y(t)$ . When infected, an individual can either stay infected, die or be cured and rejoin the susceptible class. As in the previous chapters only healthy individuals are assumed to be in the productive labour force and enter the production function. Total output  $F(x(t))$  here is produced only by the susceptible individuals ( $x(t)$ ) and is either consumed or saved and invested in specific public health infrastructure. The savings function is assumed to be determined by the composition of demand between output to be consumed and output to be invested in targeted public health infrastructure which depreciates at rate  $\phi$  with  $\phi \in [0, 1]$ . The proportion of



output destined to investment,  $s$ , is here assumed to be exogenous, positive and constant. The net growth rate of the healthy individuals ( $\alpha$ ), the TB transmission coefficient ( $\beta$ ), the mortality rate of the TB infected individuals ( $\omega$ ) and the recovery rate ( $\rho$ ) are no longer constant but functions of economic variables. Here, given that public health infrastructure investment (including housing policy) is recognised to effectively contribute towards the decline of TB prevalence and mortality, we assume that the proportion of total output, which is reinvested, goes entirely on public health capital. Therefore, here the demographic-epidemiological parameters are assumed to be functions of public health capital per healthy worker,  $z(t) = \frac{k(t)}{x(t)}$ . In what follows we consider two main scenarios depending on whether TB infected individuals can be treated/cured or not. We start with the case where recovery is included in the model.

Empirical evidence suggests<sup>233</sup> that to higher levels of  $\left(\frac{k(t)}{x(t)}\right)$  correspond lower level of TB transmission coefficient ( $\beta' \left(\frac{k(t)}{x(t)}\right) < 0$ ), total death rate of the infected individuals ( $\omega' \left(\frac{k(t)}{x(t)}\right) < 0$ ) and a higher TB recovery rate ( $\rho' \left(\frac{k(t)}{x(t)}\right) > 0$ ). Higher  $\left(\frac{k(t)}{x(t)}\right)$  here implies improvements in public health infrastructure (i.e. hospital, equipment, health related transport and general health supplies) and in housing conditions. Even though there is no clear understanding about the effect of public health infrastructure investment on the net susceptible population growth rate, in the present context we impose that an increase in public health infrastructure investment translates into a higher level of net susceptible population growth rate ( $\alpha' \left(\frac{k(t)}{x(t)}\right) > 0$ ). Furthermore, we impose that  $\alpha$ ,  $\beta$ ,  $\omega$  and  $\rho$  are bounded above by  $\bar{\alpha}$ ,  $\bar{\beta}$ ,  $\bar{\omega}$  and  $\bar{\rho}$ , respectively and below by zero. As the production function is homogenous of degree one,<sup>234</sup> we have  $F(x(t)) = gx(t)$  and changes in public

---

<sup>233</sup>Becker and Barro, 1988; Becker and Lewis, 1973; Chapman and Hariharan, 1994; Ettner, 1996; Kalemli-Ozcan et al., 2000; Krishnaji, 1983; Lincoln, 1993; Machenbach and Looman, 1993; Mutatkar, 1995; Neher, 1971; Nerlove et al., 1985; Phillips, 1993; Sundstrom and David, 1988; Waldmann, 1992.

<sup>234</sup>Output is taken to be linear in  $x(t)$ .



health capital stock are represented by

$$\dot{k}(t) = sgx(t) - \phi k(t) \quad (178)$$

with  $k(0) > 0$ .

The economic-epidemiological model of population dynamics in presence of a TB epidemic is obtained by combining (172) and (178) which results in

$$\begin{cases} \dot{x}(t) = \alpha x(t) - \frac{\beta x(t)y(t)}{x(t)+y(t)} + \rho y(t) \\ \dot{y}(t) = \frac{\beta x(t)y(t)}{x(t)+y(t)} - \omega y(t) - \rho y(t) \\ \dot{k}(t) = sgx(t) - \phi k(t) \end{cases} \quad (179)$$

Given that  $F(x(t))$  is linear, we can define  $p(t) = \frac{y(t)}{x(t)}$  and rewrite the



economic-epidemiological system (179) in terms of  $p(t)$  and  $z(t)$  as<sup>235</sup>

$$\begin{cases} \dot{p}(t) = (\beta - \alpha - \omega - \rho)p(t) - \rho p(t)^2 \\ \dot{z}(t) = sg - \phi z(t) - z(t)\left(\alpha - \frac{\beta p(t)}{1+p(t)} + \rho p(t)\right) \end{cases} \quad (180)$$

To analyse the stability properties of the economic-epidemiological system (180) we find the equilibrium points by solving the static equations  $\dot{p}(t) = 0$  and  $\dot{z}(t) = 0$ . The first steady state is at  $p_1^* = 0$  and  $z_1^*$  such that  $sg - \phi z^* - \alpha(z^*)z^* = 0$ . Any other steady state solves  $p_2^* = \frac{(\beta(z^*) - \alpha(z^*) - \omega(z^*) - \rho(z^*))}{\rho(z^*)}$  and  $z_2^*$  such that

$$\begin{aligned} & sg - \phi z^* - z^* [\alpha(z^*) - (\beta(z^*) - \alpha(z^*) - \omega(z^*) - \rho(z^*))] \\ & - z^* \left( \frac{\beta}{(\beta(z^*) - \alpha(z^*) - \omega(z^*))} + 1 \right) \end{aligned} \quad (181)$$

As equation (181) may have either no solution, one solution or multiple solutions it is difficult to analytically define the overall number of steady

---

<sup>235</sup>As

$$\dot{z}(t) = \frac{\delta \left( \frac{k(t)}{x(t)} \right)}{\delta t} = \frac{\dot{k}(t)}{x(t)} - k(t) \frac{\dot{x}(t)}{x^2(t)} \quad (f72)$$

and knowing from (179) that

$$\dot{x}(t) = \alpha x(t) - \frac{\beta x(t)y(t)}{x(t) + y(t)} + \rho y(t) \quad (f73)$$

$$\dot{k}(t) = sgx(t) - \phi k(t) \quad (f74)$$

we have

$$\dot{z}(t) = sg \frac{x(t)}{x(t)} - \phi \frac{k(t)}{x(t)} - \frac{k(t)}{x(t)} \left( \alpha \frac{x(t)}{x(t)} - \frac{\beta \frac{x(t)y(t)}{x(t)}}{\frac{x(t)+y(t)}{x(t)}} + \rho \frac{y(t)}{x(t)} \right) \quad (f75)$$

Recalling that  $z(t) = \frac{k(t)}{x(t)}$  and  $p(t) = \frac{y(t)}{x(t)}$ , (f75) can be rewritten as

$$\dot{z}(t) = sg - \phi z(t) - z(t) \left( \alpha - \beta \frac{p(t)}{1+p(t)} + \rho p(t) \right) \quad (f76)$$



states for the economic-epidemiological system (180). Instead we turn to calibration.

### 5.2.1 Calibration

We use a realistically specified model to simulate the dynamics of the economic-epidemiological system (180) (so that the speed and amplitude of the trajectories can be analysed). To do so we calibrate the non-linear differential equations by referring to WHO and WB data<sup>236</sup> on a sample of 191 countries grouped according the WHO demographic region classification. We select functional forms which provide bounded effects to public health infrastructure investment on the demographic-epidemiological factors. We select a type function where  $z(t) = \frac{k(t)}{x(t)}$

$$\begin{aligned}
 \alpha(z(t)) &= \alpha_0 - \alpha_1 \exp^{-\alpha_2 z(t)} \\
 \beta(z(t)) &= \beta_0 + \beta_1 \exp^{-\beta_2 z(t)} \\
 \omega(z(t)) &= \omega_0 + \omega_1 \exp^{-\omega_2 z(t)} \\
 \rho(z(t)) &= \rho_0 - \rho_1 \exp^{-\rho_2 z(t)}
 \end{aligned}
 \tag{182}$$

With zero capital, the baseline net growth of the healthy is  $\alpha_0 - \alpha_1$ ; the baseline infection rate is  $\beta_0 + \beta_1$ ; the baseline death rate of the infected is  $\omega_0 + \omega_1$  and the baseline recovery rate is  $\rho_0 - \rho_1$ . As the capital labour ratio,  $z$ , tends to infinity the net growth rate of the healthy is  $\alpha_0$ ; the infection rate  $\beta_0$ , the death rate of the infected  $\omega_0$  and the recovery rate is  $\rho_0$ . Consequently if  $\alpha_1$  is negative, the birth rate falls with the capital labour ratio; conversely, if  $\alpha_1$  is positive. The speed with which the upper bounds are reached is determined by the coefficients with subscript 2 (here taken to be positive). We select a specified set of demographic-epidemiological parameters based on realistic data as in the previous chapter.<sup>237</sup> With reference to the values

---

<sup>236</sup>World Bank, 2000; World Health Organization, 2000b, d.

<sup>237</sup>The value for  $\phi$  represents a weighted average of the depreciation rate of the different types of assets in the capital stock (i.e. buildings, machinaries, vehicles and human capital).



of GNP per capita, we use data from the Region of Americas and the South-East Asia Region as representative of high capital and low capital countries, respectively:  $\alpha_0 = 0.017$ ,  $\alpha_1 = 0.002$ ,  $\alpha_2 = 2$ ,  $\beta_0 = 0.794$ ,  $\beta_1 = 3.401$ ,  $\beta_2 = 3$ ,  $\omega_0 = 0.016$ ,  $\omega_1 = 0.03$ ,  $\omega_2 = 0.1$ ,  $\rho_0 = 0.791$ ,  $\rho_1 = 0.064$ ,  $\rho_2 = 1$ ,  $\phi = 0.3$  and two alternative values for the savings rates ( $s = 0.1$  and  $s = 0.2$ ) and the scale of output ( $g = 1$  and  $g = 3$ ). With these parameter values, as  $z$  varies from 0 to  $\infty$ , the net population growth rate of the healthy people varies from 1.5 per cent to 1.7 per cent, the TB transmission coefficient from 4.195 per cent to 79.4 per cent, the total death rate of the infected individual from 4.6 per cent to 1.6 per cent and the recovery rate from 72.7 per cent to 79.1 per cent.

In the first case, where  $s = 0.1$  and  $g = 1$ , the economic-epidemiological system (180) has two steady states at

$$(p_1^* = 0, \quad z_1^* = 0.317) \quad (183)$$

$$(p_2^* = 1.538, \quad z_2^* = 0.358) \quad (184)$$

A local stability analysis is carried out to examine the dynamic properties of the economic-epidemiological system (180) and (182) in the neighbourhood of each of the steady states. A Taylor expansion series of the original system of non-linear differential equations gives the following Jacobian

$$\begin{bmatrix} (\beta - \alpha - \omega - \rho - 2\rho p) & (\beta' - \alpha' - \omega' - \rho')p - \rho' p^2 \\ z [\beta/(1+p)^2 - \rho] & -\phi - (\alpha - \beta p/(1+p) + \rho p) \\ & -z(\alpha' - \beta' p/(1+p) + \rho' p) \end{bmatrix} \quad (185)$$

For convenience of exposition let  $p$  and  $z$  denote deviations from a particular steady state and derivatives in the Jacobian are evaluated at the steady state.

Evaluating (185) around the first steady state (with  $p_1^* = 0$ ) the Jacobian becomes



$$\begin{bmatrix} (\beta - \alpha - \omega - \rho) & 0 \\ z(\beta - \rho) & -(\alpha + \phi + z\alpha') \end{bmatrix} \quad (186)$$

At this steady state, as  $(\beta - \alpha - \omega - \rho) > 0$  and  $\alpha' > 0$ , the determinant is always negative and the local dynamic is characterised by a saddle point. The eigenvalues of the linearization around first steady state are both real but of opposite sign confirming the analytical results above. The values are

$$[-0.317, \quad 1.305] \quad (187)$$

Around the second steady state (both  $p_2^* \neq 0$  and  $z_2^* \neq 0$ ), the Jacobian becomes

$$\begin{bmatrix} -(\beta - \alpha - \omega - \rho) & (\beta' - \alpha' - \omega' - \rho')p - \rho'p \\ z[\beta/(1+p)^2 - \rho] & -\phi - (\alpha - \beta p/(1+p) + \rho p) \\ & -z(\alpha' - \beta' p/(1+p) + \rho' p) \end{bmatrix} \quad (188)$$

Here, the eigenvalues are both real and of negative sign leading to a stable node.

$$[-2.041, \quad -0.167] \quad (189)$$

The calibration results are shown in Fig. 30 and indicate that the second steady state is a stable attractor for all paths where  $p \neq 0$ . For initial conditions starting with relatively high TB prevalence ( $p(0) > p_2^*$ ) the economic-epidemiological system moves directly towards the stable node where  $p^* \neq 0$  and  $z^* \neq 0$ . For paths starting with  $z(0) < z_2^*$  the stock of public health capital increases. The opposite is true for paths starting with  $z(0) > z_2^*$ . In this sense it is possible for a country to be in a position of capital overaccumulation where a reduction in TB prevalence is obtained by reducing the amount of public health capital investment. For example some paths with



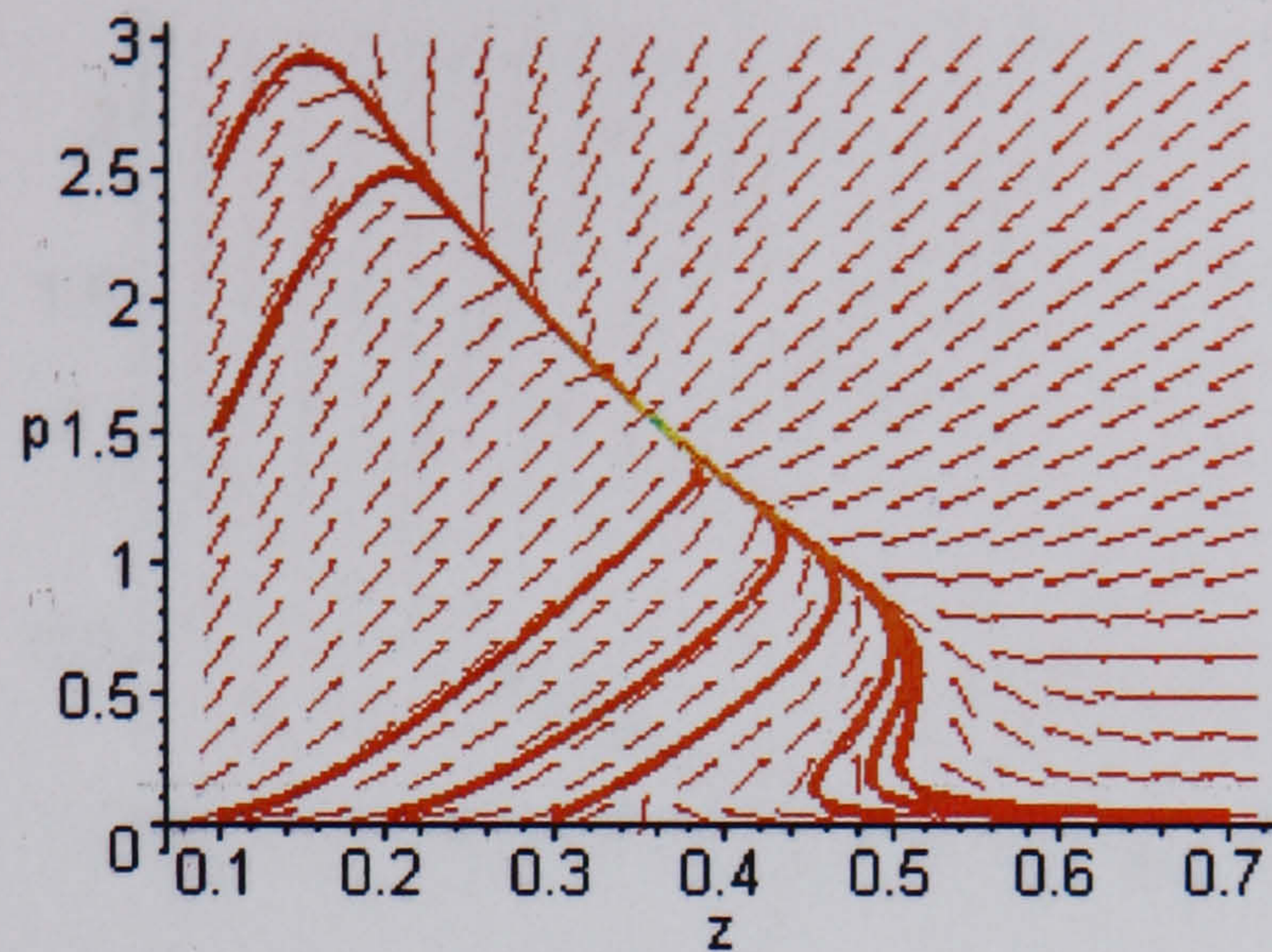

Figure 30: Global phase space diagram, economic-epidemiological model with public health investment and with recovery, two steady states,  $s = 0.1$  and  $g = 1$

initial high capital lead to capital decumulation but an increasing prevalence of the disease.

For the case where  $s = 0.2$  and  $g = 3$  the economic-epidemiological system (180) has only one steady state at

$$(p^* = 0, \quad z^* = 1.893) \quad (190)$$

The Jacobian is as in (186) and the eigenvalues corresponding to this approximation for our calibrated case are both real and of negative signs corresponding to a stable node

$$[-0.317, \quad -0.034] \quad (191)$$

The global phase space, obtained by numerically integrating the non-linear differential equations, is shown in Fig. 31. According to numerical calculations, for all the possible paths the economic-epidemiological system converges towards a steady state where the TB prevalence is reduced to zero. However, on some of these paths ( $z(0) > z_2^*$ ) there is still decumulation of capital.



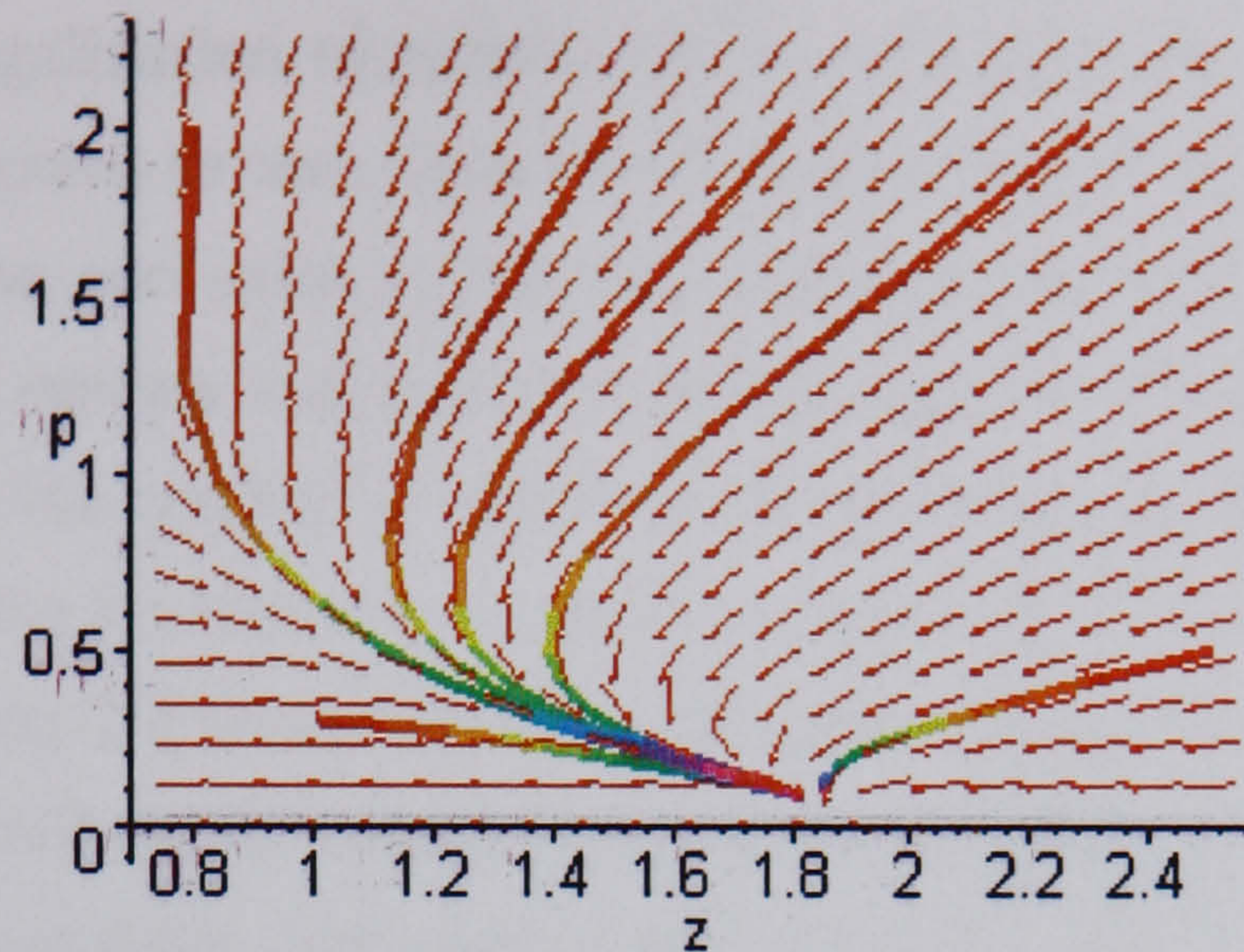

Figure 31: Global phase space diagram, economic-epidemiological model with public health investment and with recovery, one steady state,  $s = 0.2$  and  $g = 3$

### 5.3 Descriptive Analysis: Economic-Epidemiological Model without Recovery

Public health infrastructure investment does not always imply TB infected individuals can be treated and efficiently cured. Increasing the quantity of resources invested in health related services does not always ensure lasting change in the economic-epidemiological system capacity.<sup>238</sup> When the economic-epidemiological system is surrounded by a hostile environment it is difficult to transform resources into effective health care.<sup>239</sup> Multilateral institutions like the WHO and United Nations Children's Fund (UNICEF), although charged with improving social welfare in developing countries, are subjected to the accountability to the institutions's financiers which often pressure them to seek short-term results from their investments and without guaranteeing continuity in the investments.<sup>240</sup> Internal political conditions can also negatively affect the deployment of health related investment. For

<sup>238</sup>LaFond, 1995.

<sup>239</sup>Brinkerhoff and Goldsmith, 1992.

<sup>240</sup>LaFond, 1995; Walt, 1993.



instance, the legalization of private health care in Vietnam, although it has facilitated the access to care, because of the absence of regulations concerning drug importation and sales, it has also increased the abuse of the economic-epidemiological system and waste of health related resources.<sup>241</sup> In the light of these gaps in the quality of public health investment, we consider the case where output can be either consumed or invested in targeted public health infrastructure but TB treatment is inefficient and therefore negligible. Notice that there are still public health infrastructure effects on demographics and on the TB transmission (preventive public health effects). The equations of motion are

$$\begin{cases} \dot{x}(t) = \alpha x(t) - \frac{\beta x(t)y(t)}{x(t)+y(t)} \\ \dot{y}(t) = \frac{\beta x(t)y(t)}{x(t)+y(t)} - \omega y(t) \\ \dot{k}(t) = sgx(t) - \phi k(t) \end{cases} \quad (192)$$

where  $\alpha$ ,  $\beta$  and  $\omega$  are functions of public health capital per healthy labour worker ( $z(t) = \frac{k(t)}{x(t)}$ ).

Given that  $F(x(t))$  is linear we can define  $p(t) = \frac{y(t)}{x(t)}$  and rewrite the economic-epidemiological system (192) in terms of  $p(t)$  and  $z(t)$  as

$$\begin{cases} \dot{p}(t) = (\beta - \alpha - \omega)p(t) \\ \dot{z}(t) = sg - \phi z(t) - z(t)\left(\alpha - \frac{\beta p(t)}{1+p(t)}\right) \end{cases} \quad (193)$$

To analyse the stability properties of the economic-epidemiological system (193) we find the equilibrium points by solving the static equations  $\dot{p}(t) = 0$  and  $\dot{z}(t) = 0$ . Given that the demographic-epidemiological elements are constant at the equilibrium points, there are up to two steady states in which  $p$  and  $z$  are constant.

(i) The first steady state is at  $p_1^* = 0$  and  $z^*$  such that  $sg - \phi z^* - \alpha z^* = 0$  leading to  $z^* = \frac{sg}{\alpha + \phi}$ .

(ii) The second steady state, where it exists, is at  $p_2^* \neq 0$  and  $z^*$  solves  $[\beta(z^*) - \alpha(z^*) - \omega(z^*)] = 0$ . In this steady state the TB infected/susceptible

---

<sup>241</sup>LaFond, 1995.



structure of the population is constant through time with a nonzero TB prevalence and the public health capital per healthy labour worker is nonzero and constant. Furthermore, solving  $\dot{z}(t) = sg - \phi z(t) - z(t)(\alpha - \frac{\beta p(t)}{1+p(t)}) = 0$  for  $p$  we have

$$p^* = -\frac{(sg - \phi z^* - \alpha z^*)}{(sg - \phi z^* - \alpha z^* + \beta z^*)} \quad (194)$$

We require the denominator to be nonzero. Furthermore, as only  $p^* \geq 0$  are feasible TB prevalence solutions, equation (194) requires numerator and denominator to be of opposite signs. As  $\beta z > 0$ , the numerator needs to be negative. We know that  $sg - \phi z^* - \alpha z^*$  vanishes at  $z^* = \frac{sg}{(\alpha + \phi)}$  (the first steady state with  $p^* = 0$ ) and it is negative for  $z^* < \frac{sg}{(\alpha + \phi)}$ .

Consider  $z_a$  and  $z_b$  as the roots which solve, respectively,

$$sg - \phi z_a - \alpha z_a = 0 \quad (195)$$

$$[\beta(z_b) - \alpha(z_b) - \omega(z_b)] = 0 \quad (196)$$

It can be shown that if  $z_a > z_b$  there is a unique steady state at  $p_1^* = 0$  and  $z_1^* = z_a$ . In this case, for any initial conditions of public health capital per healthy labour worker less than  $z_1$ , at first, while public health capital accumulates, TB prevalence falls. The reduction in the number of TB infected people corresponds to an increase in the number of susceptible individuals. A public health capital widening effect occurs and the accumulation of public health capital is reduced. Thereafter, TB prevalence increases and so does public health accumulation but at a lower rate.

For initial public health capital per healthy labour worker greater than  $z_1$ , at first, while public health capital decumulates, TB prevalence falls. In this situation a reduction of public health capital is required to improve the control of the disease spread. The reduction in the number of TB infected



people corresponds to an increase in the number of susceptible individuals. A public health capital widening effect occurs and the accumulation of public health capital is reduced. At this point, TB prevalence starts increasing and so does public health accumulation but at a higher rate. For  $z_a < z_b$ , when there are two steady states, one is at  $p_1^* = 0$  and  $z_1^* = z_a$  and the other is at  $p_2^* = -\frac{(sg - \phi z_2^* - \alpha z_2^*)}{(sg - \phi z_2^* - \alpha z_2^* + \beta z_2^*)}$  evaluated at  $z_2^* = z_b$ . Here, for initial levels of TB prevalence less than  $p_2^*$  the economic-epidemiological system tends towards a steady state with endemic disease ( $p_2^*$ ). TB prevalence increases for values of  $p$  greater than  $p_2^*$ . However, even if  $z_a < z_b$  the second steady state may not exist. If  $g$  is relatively high since then the linearity of the production function may make the system so productive that even at very high levels of disease only a finite  $z$  is necessary to keep  $\dot{z} = 0$ .

A local stability analysis is carried out to examine the dynamic properties of the economic-epidemiological system (193) in the neighbourhood of each of the steady states. A Taylor series expansion of the original economic-epidemiological system of non-linear differential equations gives the following Jacobian

$$\begin{bmatrix} (\beta - \alpha - \omega) & (\beta' - \alpha' - \omega')p \\ z\beta/(1+p)^2 & -\phi - (\alpha - \beta p/(1+p)) \\ & -z(\alpha' - \beta' p/(1+p)) \end{bmatrix} \quad (197)$$

where  $p$  and  $z$  are now measured as deviations from a particular steady state and derivatives in the Jacobian are evaluated at the relevant steady state. Setting  $p_1^* = 0$  around the first steady state the Jacobian becomes

$$\begin{bmatrix} (\beta(z^*) - \alpha(z^*) - \omega(z^*)) & 0 \\ sg\beta/(\alpha + \phi) & -[\alpha + \phi + sg\alpha' / (\alpha + \phi)] \end{bmatrix} \quad (198)$$

As at this steady state the determinant is either negative (for  $(\beta(z^*) - \alpha(z^*) - \omega(z^*)) > 0$  when  $z_a < z_b$ ) or positive (for  $(\beta(z^*) - \alpha(z^*) - \omega(z^*)) > 0$  when  $z_a > z_b$ ), the local dynamic is characterised either by a saddle point or a stable node, respectively.



Around the second steady state (both  $p_2^* \neq 0$  and  $z_2^* \neq 0$ ), when it exists ( $(\beta - \alpha - \omega) > 0$ ) the Jacobian becomes

$$\begin{bmatrix} 0 & (\beta' - \alpha' - \omega')p \\ z\beta/(1+p)^2 & -\phi - (\alpha - \beta p/(1+p)) - z(\alpha' - \beta' p/(1+p)) \end{bmatrix} \quad (199)$$

Although the determinant is positive, the trace has an ambiguous sign. Therefore this steady state can be characterised either by local stability or local instability. The global phase spaces for each case are in Fig. 32a, b, c.

### 5.3.1 Calibration

Next we calibrate the non-linear economic-epidemiological system in (193) to show the speed and amplitude of the dynamics. We select the same functional forms and data<sup>242</sup> we used in the previous chapter and in Section 5.2. Specifically, with reference to the values of GNP per capita, we use data from the Region of Americas and the South-East Asia Region as representatives of high capital and low capital countries:  $\alpha_0 = 0.017$ ,  $\alpha_1 = 0.002$ ,  $\alpha_2 = 2$ ,  $\beta_0 = 0.028$ ,  $\beta_1 = 0.26$ ,  $\beta_2 = 3$ ,  $\omega_0 = 0.016$ ,  $\omega_1 = 0.030$ ,  $\omega_2 = 0.1$ ,  $\phi = 0.3$ ,  $g = 1$  and three alternative values for the savings rate:  $s = 0.3$ ,  $s = 0.2$  and  $s = 0.1$ . With these parameter values, as  $z$  varies from 0 to  $\infty$ , the net population growth rate of the healthy people varies from 1.7 per cent to 1.5 per cent, the TB transmission coefficient from 28.6 per cent to 2.8 per cent, and the total death rate of the infected individual from 4.6 per cent to 1.6 per cent.

The case with  $s = 0.2$  has two steady states:

$$(p_1^* = 0, \quad z_1^* = 0.632) \quad (200)$$

$$(p_1^* = 0.862, \quad z_2^* = 0.693) \quad (201)$$

---

<sup>242</sup>World Bank, 2000; World Health Organization, 2000b, d.



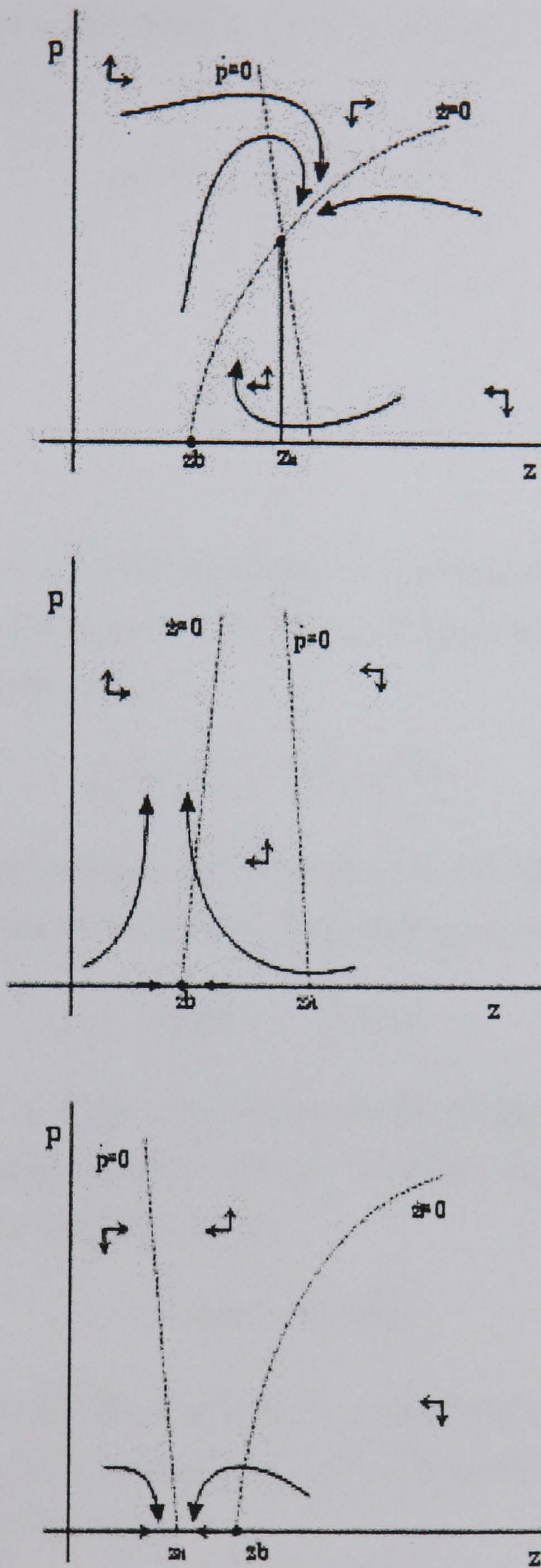

Figure 32: Phase-plane diagram, economic-epidemiological model with public health investment with no recovery: a) two steady states,  $z_a < z_b$ ; b) one steady state,  $z_a < z_b$ ; c) one steady state,  $z_a > z_b$



When  $s = 0.1$  or  $s = 0.3$  there is a single steady<sup>243</sup> state either at

$$(p_1^* = 0, \quad z_1^* = 0.317) \quad (202)$$

or

$$(p_1^* = 0, \quad z_1^* = 0.947) \quad (203)$$

respectively.

For the case with  $s = 0.2$  the eigenvalues corresponding to a linear approximation around the first steady state ( $p^* = 0$ ) are both real but of opposite signs leading to a saddle point.

$$[-0.317, \quad 0.1(10)^{-10}] \quad (204)$$

Around the second steady state (both  $p_2^* \neq 0$  and  $z_2^* \neq 0$ ), the eigenvalues are both real and of negative signs corresponding to a stable node.

$$[-0.317, \quad -0.003] \quad (205)$$

For the case with  $s = 0.1$  the eigenvalues corresponding to a linear approximation around the unique steady state ( $p^* = 0$ ) are both real but of opposite signs corresponding to a saddle point.

$$[-0.317, \quad 0.068] \quad (206)$$

For the case with  $s = 0.3$  the eigenvalues corresponding to a linear approximation around the unique steady state ( $p^* = 0$ ) are both negative and real corresponding to a stable node

$$[-0.317, \quad -0.017] \quad (207)$$

The calibration results for the case with two steady states is represented in Fig. 33 while the cases with a single steady state for  $z_a < z_b$  and  $z_a > z_b$ .

---

<sup>243</sup>The case with  $s = 0.1$  has  $z_a < z_b$  while the case with  $s = 0.3$  has  $z_a > z_b$ .



are in Fig. 34 and Fig. 35, respectively. The results for the calibrated example with two steady states indicate that the second steady state is a stable attractor for all the paths where  $p \neq 0$ . The public health capital line between the first and the second steady state constitutes a threshold which separates paths from either accumulating or decumulating the stock of public health capital. For initial conditions starting with relatively high TB prevalence ( $p(0) > p_2^*$ ) and with  $z(0) < z_2^*$ , the economic-epidemiological system moves towards the stable node where  $p^* \neq 0$  and  $z^* \neq 0$  with a reduction in the TB prevalence and an increase in the stock of public health capital. For paths starting with relatively high TB prevalence ( $p(0) > p_2^*$ ) and with  $z(0) > z_2^*$ , the economic-epidemiological system moves towards the nonzero stable node with a reduction in both the TB prevalence and the stock of public health capital. Initial conditions with  $p(0) < p_2^*$  and  $z(0) < z_2^*$  generate paths which tend towards the stable steady state with  $p^* \neq 0$  and  $z^* \neq 0$  with an increase both in the TB prevalence and in the stock of public health capital. Initial conditions with  $p(0) < p_2^*$  and  $z(0) > z_2^*$  lead the economic-epidemiological system towards the stable steady state with  $p^* \neq 0$  and  $z^* \neq 0$  with an increase in the TB prevalence and a reduction in the stock of public health capital. According to numerical calculations for the case with one steady state, the  $\dot{z} = 0$  trajectory represents the public health capital threshold which separates paths from either accumulating or decumulating the stock of public health capital. Specifically, for any initial conditions  $z(0) < z_2^*$  TB initially decreases and then rises again while public health capital stock is accumulated. For  $z(0) > z_2^*$  TB prevalence and public health capital move in opposite directions in that the number of TB infected people over the number of susceptible people increases and public health capital decumulates.

By considering the two-way interaction between the productive capacity of the economic-epidemiological system and the demographic-epidemiological structure and allowing for TB infectious individuals receiving treatment and be actually cured, we find that the economic-epidemiological system can set-



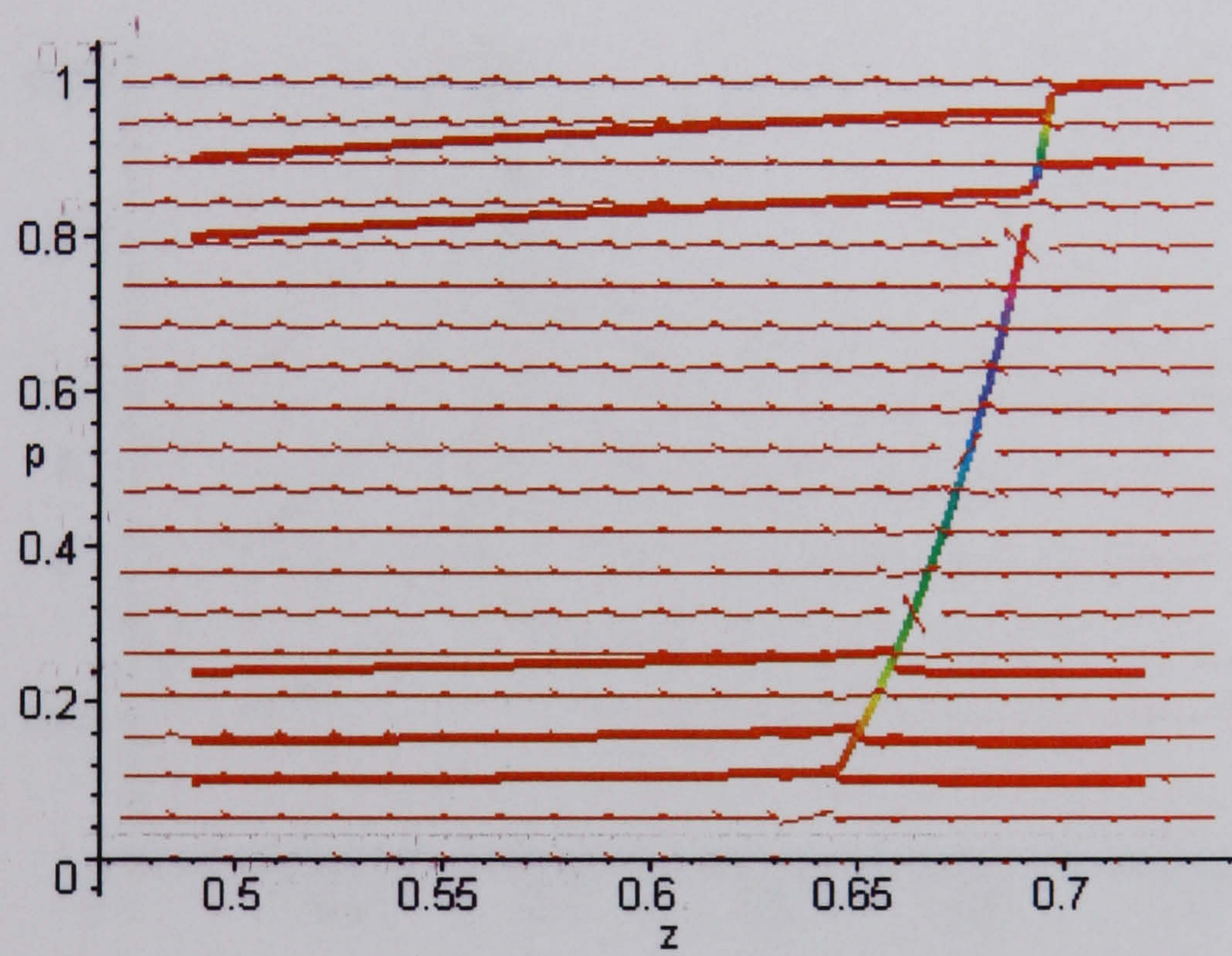

Figure 33: Global phase-plane diagram, economic-epidemiological model with public health investment with no recovery,  $s = 0.2$  and  $z_a < z_b$ , two steady states



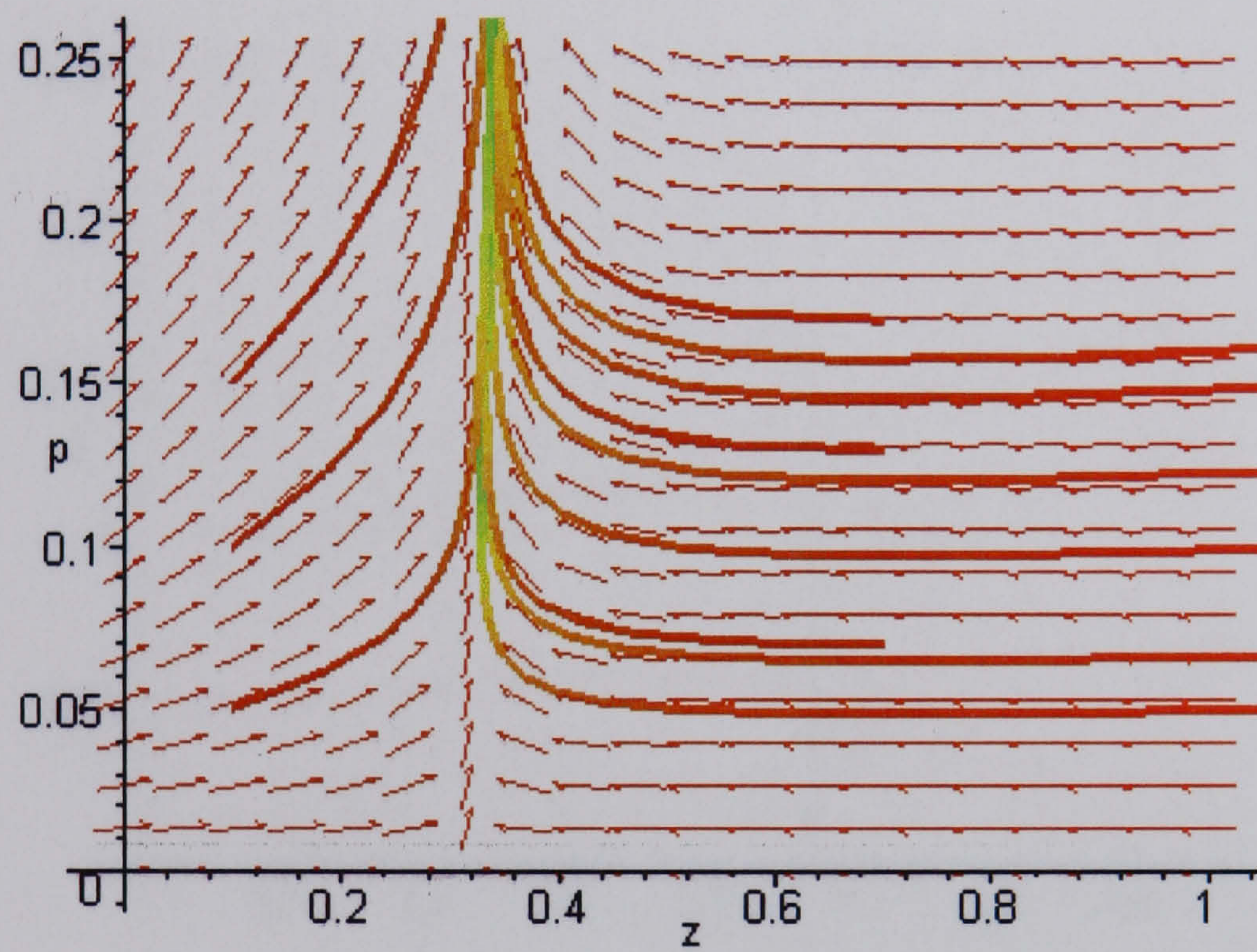

Figure 34: Global phase-plane diagram, economic-epidemiological model with public health investment with no recovery,  $s = 0.1$  and  $z_a < z_b$ , one steady state



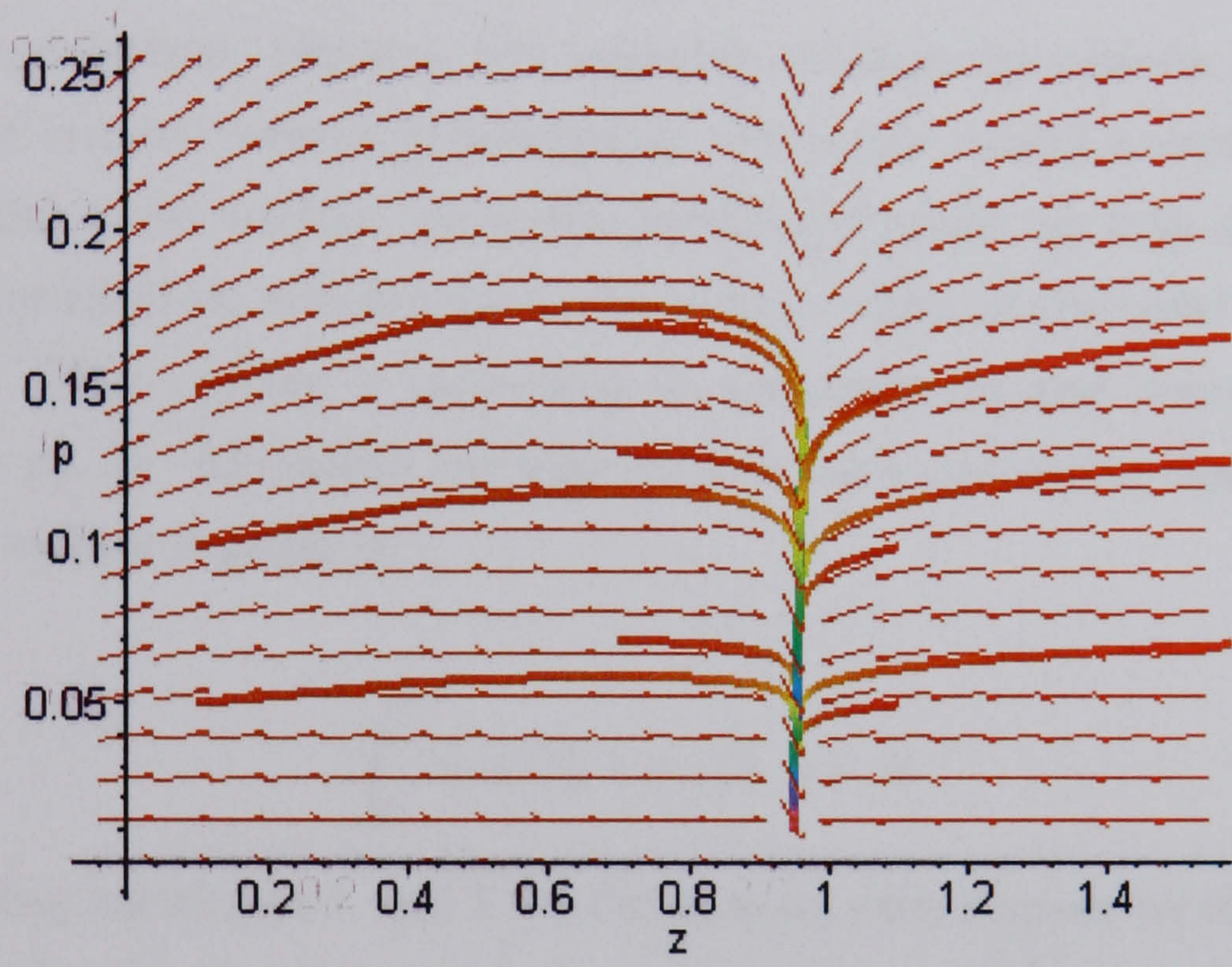

Figure 35: Global phase-plane diagram, economic-epidemiological model with public health investment with no recovery,  $s = 0.3$  and  $z_a > z_b$ , one steady state



tle down at zero TB prevalence level. This result contrasts with the pure demographic-epidemiological setting, where TB prevalence can only asymptotically tend towards zero, and when the economic-epidemiological setting without recovery, where the economic-epidemiological system settles down to a positive and finite TB prevalence level.

## 5.4 Optimal Control Analysis

The central planner facing a TB epidemic chooses his actions so that the division of output between consumption and public health investment is set to maximise social welfare. As in the previous chapter, we take a time additive welfare function which reflects the social welfare of the total population at any  $t$ . Here, utility is increasing in consumption and decreasing in  $p$  ( $u(c/(1+p), \dot{p})$ ). Moreover, we take  $u(\cdot)$  to be a decreasing function of  $\dot{p}$ . At any  $t$  welfare is given by

$$\int_0^T u(c/(1+p), \dot{p}) > 0 dt \quad (208)$$

where, using subscripts 1 and 2 for derivatives with respect to the first and second argument of  $u(c/(1+p), \dot{p})$ , we assume, as in Section 4.3,  $u_1 > 0$ ,  $u_2 < 0$ ,  $u_{11} < 0$  and  $u_{22} < 0$ . Generally, we also take  $u_{12} = 0$ . Later, for simplicity, we also impose  $u_2 = 0$ . Furthermore, we require  $u_1 \rightarrow \infty$  as  $c/(1+p) \rightarrow 0$ .

### 5.4.1 Necessary Conditions for Optimality

Instead of taking the savings rate to be exogenous, we have a centrally planned economy in which savings is chosen to balance the welfare effects of current and future per capita consumption of the total population and the effects of public health investment on the spread of the disease. The policy problem becomes that of



$$\max \int_0^T u(c/(1+p), \dot{p}) dt \quad (209)$$

subject to

$$\dot{p}(t) = (\beta - \alpha - \omega - \rho)p(t) - \rho p^2 \quad (210)$$

$$\dot{z}(t) = g - \phi z(t) - z(t)\left(\alpha - \frac{\beta p(t)}{1+p(t)} + \rho p\right) - c \quad (211)$$

The Hamiltonian<sup>244</sup> is

<sup>244</sup>With time discounting the analysis of this case has a welfare function

$$\int_0^T e^{-rt} u(c/(1+p), \dot{p}) dt \quad (f77)$$

where the discounted or present value Hamiltonian is

$$\begin{aligned} \bar{H} = e^{-rt} u(c/(1+p), \dot{p}) + \lambda_1 \left[ g - \phi z(t) - z(t)\left(\alpha - \frac{\beta p(t)}{1+p(t)} + \rho p(t)\right) - c \right] \\ + \lambda_2 [(\beta - \alpha - \omega - \rho)p(t) - \rho p(t)^2] \end{aligned} \quad (f78)$$

By introducing the costate variables  $\xi_1$  and  $\xi_2$  and the Hamiltonian

$$\tilde{H} = u(c/(1+p), \dot{p}) + \xi_1 \left[ f(z) - \phi z(t) - z(t)\left(\alpha - \frac{\beta p(t)}{1+p(t)}\right) - c \right] + \xi_2 p(t)(\beta - \alpha - \omega) \quad (f79)$$

with  $\xi_1 = e^{-rt} \lambda_1$  and  $\xi_2 = e^{-rt} \lambda_2$  In this case the necessary conditions are

$$u_1 = \xi_1(1+p) \quad (f80)$$

$$\begin{aligned} \dot{\xi}_1 = & \xi_1[\alpha - \beta p/(1+p) + \rho p + \phi + z(\alpha' - \beta' p/(1+p))] \\ & + \xi_1 r - (\xi_2 + u_2)(\beta' - \alpha' - \omega' - \rho')p - \rho' p^2 \end{aligned} \quad (f81)$$



$$H = u(c/(1+p), \dot{p}) + \lambda_1 \left[ g - \phi z(t) - z(t) \left( \alpha - \frac{\beta p(t)}{1+p(t)} + \rho p(t) \right) - c \right] + \lambda_2 [(\beta - \alpha - \omega - \rho)p(t) - \rho p(t)]^2 \quad (212)$$

Optimizing  $H$  over the control variable,  $c$ , leads, as in Section 4.3.2, to

$$\frac{\delta H}{\delta c} = \frac{u_1}{(1+p)} - \lambda_1 = 0 \quad (213)$$

or

$$u_1 = \lambda_1(1+p) \quad (214)$$

where the marginal utility of consumption per overall capita divided by  $(1+p)$  is equal to the marginal value of public health investment per healthy worker.

The equations of motion for the costate variables,  $p$  and  $z$ , respectively, are

$$-\frac{\delta H}{\delta z} = \dot{\lambda}_1 = \lambda_1 [\alpha + \phi - \beta p/(1+p) + \rho p + z(\alpha' - \beta' p/(1+p) + \rho' p)] - (\lambda_2 + u_2) [(\beta' - \alpha' - \omega' - \rho')p - \rho' p^2] \quad (215)$$

---

$$\dot{\xi}_2 = \xi_1 [c/(1+p) - \beta z/(1+p)^2 + \rho z] - (\xi_2 + u_2)(\beta - \alpha - \omega - \rho - 2\rho p) + r(\xi_2 + u_2) \quad (\text{f82})$$

Equations (212) and (f82) can be re-written as

$$\dot{\xi}_1 = \xi_1 [\alpha - \beta p/(1+p) + \rho p + \phi + z(\alpha' - \beta' p/(1+p)) + r] - (\xi_2 + u_2)(\beta' - \alpha' - \omega')p \quad (\text{f83})$$

and

$$\dot{\xi}_2 = \xi_1 [c/(1+p) - \beta z/(1+p)^2] - (\xi_2 + u_2)(\beta - \alpha - \omega - \rho - 2\rho p - r) \quad (\text{f84})$$

Discounting affects the steady state values of the costate variables and adds a growth term to their dynamics.



$$-\frac{\delta H}{\delta p} = \dot{\lambda}_2 = \lambda_1 \left[ \frac{c}{(1+p)} - \frac{\beta z}{(1+p)^2} + \rho z \right] - (\lambda_2 + u_2)(\beta - \alpha - \omega - \rho - 2\rho p) \quad (216)$$

The necessary conditions for optimality<sup>245</sup> (211)-(213)-(214)-(215)-(216) have appealing interpretations. Specifically, equation (215) indicates the increase in the value of public health capital due to new birth, depreciation of capital stock, recovery of previously TB infected individuals. However, the value of capital decreases as the number of healthy individuals (and the amount of capital widening increases) falls. Furthermore, the marginal effects of capital on the net growth rate of the healthy workers on the rate of TB prevalence and the recovery rate are of ambiguous sign. A higher level of prevalence, by increasing the number of TB infected individuals and reducing the number of healthy workers, translates in an increase of the capital deepening effect of a given amount of investment and in a reduction of the values of the current overall per capita consumption of the whole population ( $c/(1+p)$ ). Here, equation (216) reveals that the shadow price for the TB prevalence for the future rises because of its effects in reducing the instantaneous utility and of the recovery of previously infected people. However, it falls because of its effects on the future value of investment (via the reduction in the number of healthy individuals) and because of the future growth of prevalence.

#### 5.4.2 Dynamic Analysis

To analyse the dynamic properties of the economic-epidemiological system in (210)- (211)-(215)-(216) we examine the steady states. Under the assumption that  $\alpha > 0$  and  $\alpha' \geq 0$ , the economic-epidemiological system has no steady state with  $p^* = 0$  as (215), for  $\lambda_1 \neq 0$ , reduces to

$$z = -(\alpha + \phi + \rho)/\alpha' \quad (217)$$

---

<sup>245</sup>In Section 5.4.4 we consider their sufficiency and also whether a solution exists to the problem.



which takes a negative value and therefore it is not a feasible solution. There may be however one or more steady states with  $p^* \neq 0$  where  $p^* = \frac{(\beta - \alpha - \omega - \rho)}{\rho}$ ,  $z^*$  solves  $g - \phi z - z(\alpha - \frac{\beta p^*}{1+p^*} + \rho p^*) - c$ ,  $\lambda_1^*$  and  $\lambda_2^*$  solve, respectively,

$$\begin{aligned} & \lambda_1[\alpha + \phi - \beta p/(1+p) + \rho p + z(\alpha' - \beta' p/(1+p))] \\ & - \lambda_2 [(\beta' - \alpha' - \omega' - \rho')p - \rho' p^2] = 0 \end{aligned} \quad (218)$$

and

$$\lambda_1 [c/(1+p) - \beta z/(1+p)^2 + \rho z] - \lambda_2(\beta - \alpha - \omega - \rho - 2\rho p) = 0 \quad (219)$$

We analyse the local dynamics of the system of non-linear equations (211)-(214)-(216)-(215) by examining the characteristic roots of the Jacobian (see Appendix A.5 for detailed calculations). The qualitative structure of the Jacobian is

$$\begin{bmatrix} a - \pi & b & 0 & 0 \\ c & d - \pi & e & 0 \\ f & g & -d - \pi & -b \\ h & f & -c & -a - \pi \end{bmatrix} \quad (220)$$

so that the characteristic equation is

$$\pi^4 + \pi^2[-a^2 - d^2 - 2bc - eg] + [a^2 d^2 - 2abcd + a^2 eg - 2abef + b^2 c^2 + b^2 eh] \quad (221)$$

which can be reparametrised, in similar vein to the productive capital model in Section 4.3.2, as

$$\Pi^2 + \Pi A + B \quad (222)$$

where

$$\Pi = \pi^2 \quad (223)$$



$$A = -a^2 - d^2 - 2bc - eg \quad (224)$$

$$B = a^2d^2 - 2abcd + a^2eg - 2abef + b^2c^2 + b^2eh \quad (225)$$

If both  $(A^2 - 4B)$  and  $(-A - \sqrt{(A^2 - 4B)})$  are positive there are two pairs of real roots of equal absolute value but opposite sign which corresponds to a 4-D saddle point. When  $(A^2 - 4B)$  is positive and  $(-A \pm \sqrt{(A^2 - 4B)})$  is negative then there are two pairs of imaginary roots. When both  $(A^2 - 4B)$  and  $(-A + \sqrt{(A^2 - 4B)})$  are positive and  $(-A - \sqrt{(A^2 - 4B)})$  is negative then there is one pair of pure imaginary and a pair of real roots of opposite sign. When  $(A^2 - 4B)$  is negative we have two pairs of complex conjugate roots with the common real part of each pair being of equal absolute value but opposite sign. We can think of this as a combination of a 4-D saddle point and locally oscillatory solutions. Summarising, the possibilities are shown in Table 5.1

$(A^2 - 4B)$	$> 0$	$> 0$	$> 0$	$< 0$
$(-A - \sqrt{(A^2 - 4B)})$	$> 0$	$< 0$	$< 0$	
$(-A + \sqrt{(A^2 - 4B)})$		$< 0$	$> 0$	
	4-D saddle	focus	cycles	4-D saddle with local oscillations

Table 5.1: Optimal control of public health investment model, local dynamics

### 5.4.3 Calibration

To contrast the deterministic case with the optimal trajectory we refer to the same data set<sup>246</sup> as in Section 5.2.1. We limit our analysis to the case of an isoelastic utility so that  $u(c/(1+p), \dot{p}) = (c/(1+p))^{(1-b)}/(1-b)$  where

<sup>246</sup>World Bank, 2000; World Health Organization, 2000b, d.



$b > 0$ .<sup>247</sup> We have:  $\alpha_0 = 0.017$ ,  $\alpha_1 = 0.002$ ,  $\alpha_2 = 2$ ,  $\beta_0 = 0.794$ ,  $\beta_1 = 3.401$ ,  $\beta_2 = 3$ ,  $\omega_0 = 0.016$ ,  $\omega_1 = 0.03$ ,  $\omega_2 = 0.1$ ,  $\rho_0 = 0.791$ ,  $\rho_1 = 0.064$ ,  $\rho_2 = 1$ ,  $b = 2$ ,  $\phi = 0.3$ ,  $g = 1$ .

With these parameter values the optimal control model with public health investment (including the possibility of recovery) has one steady state at

$$(p^* = 0.136, \quad z^* = 1.065, \quad \lambda_1^* = 2.528, \quad \lambda_2^* = -15.408) \quad (226)$$

At this steady state consumption per healthy worker is 0.67 and the level of utility is -1.69 which is the also the value of the Hamiltonian at the steady state.

The eigenvalues for the calibrated case are

$$[\pm 0.727, \quad \pm 0.087] \quad (227)$$

With these chosen parameters the steady state shows dual instability of a saddle point type and there are no oscillation. This is reflected by the fact that all the eigenvalues are real.

To display the results remaining in at most three dimensions, we used the methodology applied in Section 4.3.3 by integrating around contours of the Hamiltonian.<sup>248</sup> As along any solution path for  $[p(t), z(t), \lambda_1(t), \lambda_2(t)]$ , the Hamiltonian is identically constant, we can use the equation

$$\begin{aligned} \bar{H} = & u \left( \frac{c(\lambda_1(t), p(t))}{(1 + p(t))} \right) \\ & + \lambda_1(t) \left[ g - \phi z(t) - z(t) \left( \alpha - \frac{\beta p(t)}{1 + p(t)} + \rho p(t) \right) - c(\lambda_1(t), p(t)) \right] \\ & + \lambda_2(t) [(\beta - \alpha - \omega - \rho)p(t) - \rho p(t)]^2 \end{aligned} \quad (228)$$

to solve for  $\lambda_2(t)$

---

<sup>247</sup>The value for the elasticity of marginal utility of consumption,  $b$ , is chosen within the range of values provided by Deaton, 1992.

<sup>248</sup>Dankowicz, 1997.



$$\lambda_2(t) = \frac{\left[ \bar{H} - u \left( \frac{c(\lambda_1(t), p(t))}{(1+p(t))} \right) \right]}{[(\beta - \alpha - \omega - \rho)p(t) - \rho p(t)]^2} - \frac{\lambda_1(t) \left[ g - \phi z(t) - z(t) \left( \alpha - \frac{\beta p(t)}{1+p(t)} + \rho p(t) \right) - c(\lambda_1(t), p(t)) \right]}{[(\beta - \alpha - \omega - \rho)p(t) - \rho p(t)]^2} \quad (229)$$

where  $\bar{H}$  is the constant value of the Hamiltonian on the surface. We substitute the expression (229) for  $\lambda_2(t)$  into the differential equations for the other variables  $p(t)$ ,  $z(t)$  and  $\lambda_1(t)$  so that the economic-epidemiological system of four non linear equations is reduced to three dimensions without losing any information. Therefore, in the  $\dot{\lambda}_1$  equation (215) we substitute the term in  $\lambda_2$  with the expression in (229). The three dimensional global phase space in  $[p(t), z(t), \lambda_1(t)]$  is shown in Figs. 36. Here the level surface of the Hamiltonian is  $\bar{H} = 2.064$ . There are two families of paths. Those starting with high values of capital per healthy worker ( $z(t) > z^*$ ) and low values of the shadow price of capital ( $\lambda_1(t) < \lambda_1^*$ ) satisfy the transversality conditions with  $\lambda_1(t)$  first rising but subsequently tending towards zero and both  $z(t)$  and  $p(t)$  continuously fall. The set of paths starting with a higher value of  $\lambda_1(t)$  but still  $\lambda_1(t) < \lambda_1^*$  and with high values of  $z(t)$ , lead to  $\lambda_1(t)$  diverging,  $z(t)$  and  $p(t)$  falling again. The optimal time paths are of the form of Fig. 37, 38, 39, 40.

For any initial condition the economic-epidemiological system shows to be stable in  $p$  and  $z$  and unstable in  $\lambda_1$  and  $\lambda_2$ . Specifically,  $\lambda_1$  is shown eventually to grow without bound and  $\lambda_2$  tends towards  $-\infty$ . In the  $[p(t), z(t), \lambda_1(t)]$  plane, for paths starting with low values of  $p$  and  $\lambda_1$  there is a relatively fast movement of  $\lambda_1$ . For paths starting at higher values of  $p$  (and relatively low values of  $\lambda_1$ ) the movements in  $\lambda_1$  are very slow.

#### 5.4.4 Sufficient Conditions for Optimality

Consider the sufficiency of the necessary conditions for optimal control. Recall that the demographic-epidemiological parameters are function of the



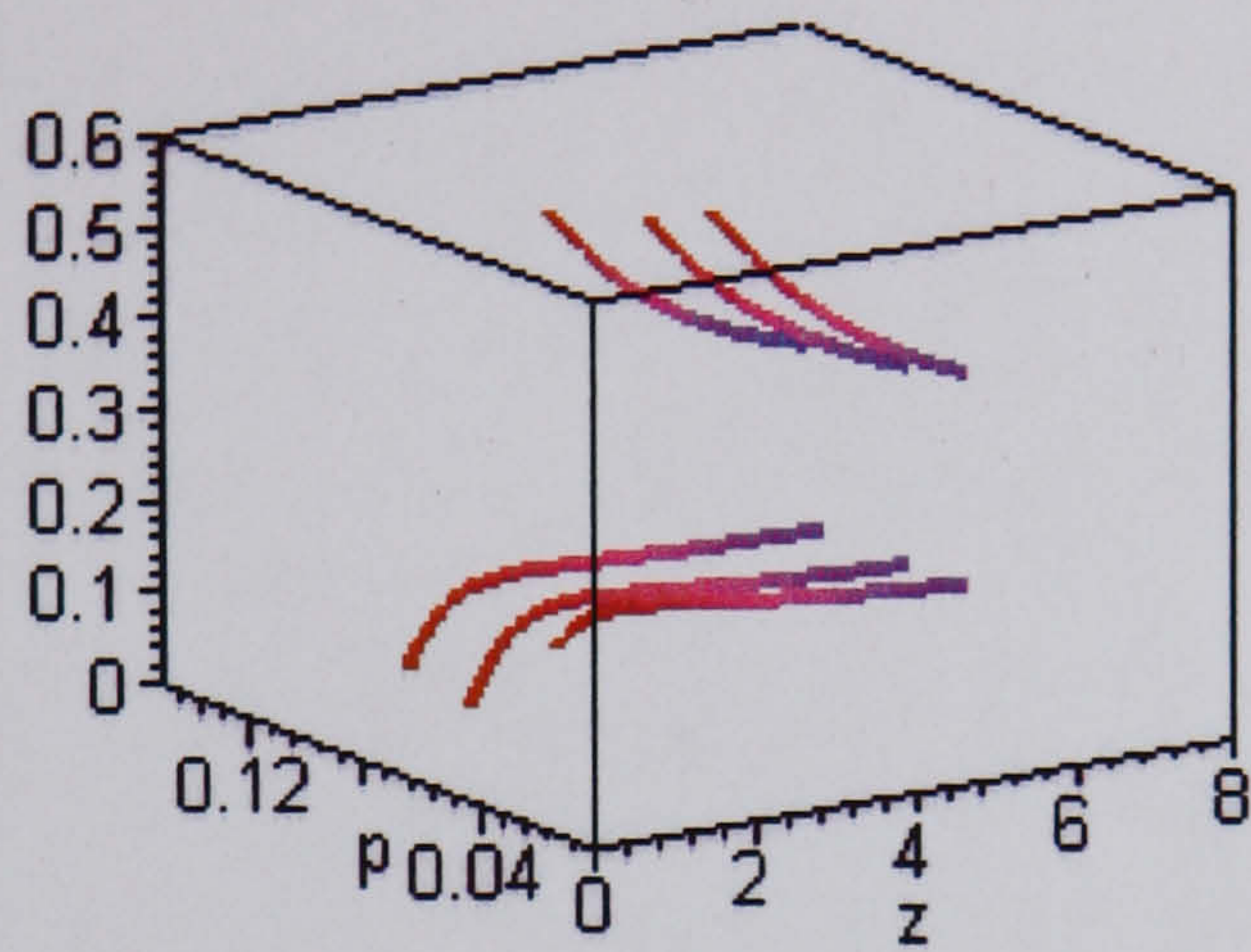

Figure 36: Global phase-space diagram, optimal control, economic-epidemiological model with public health investment and with recovery

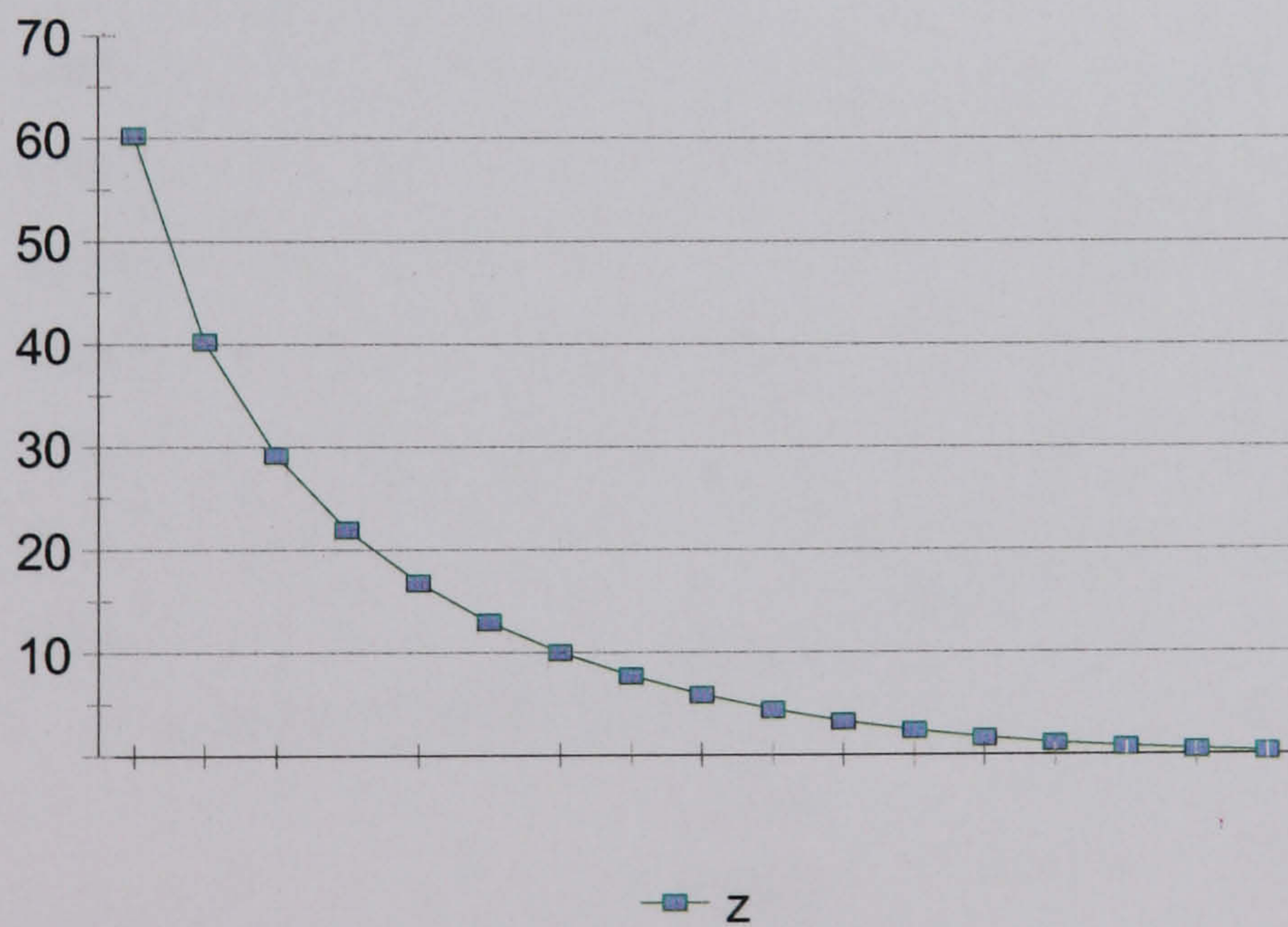

Figure 37: Time behaviour of  $z$  for  $z(0) = 60.27$



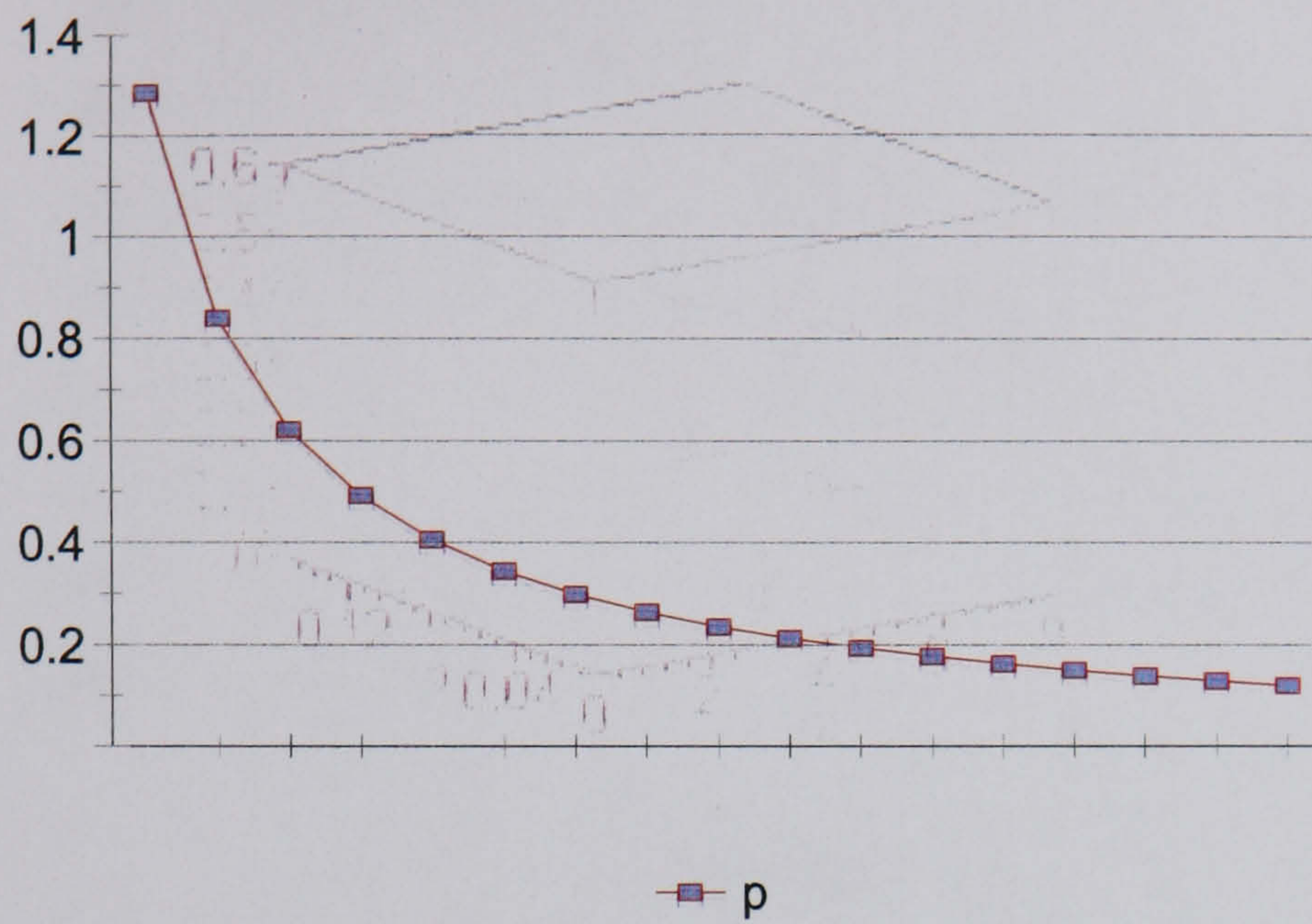

Figure 38: Time behaviour of  $p$  for  $p(0) = 1.29$

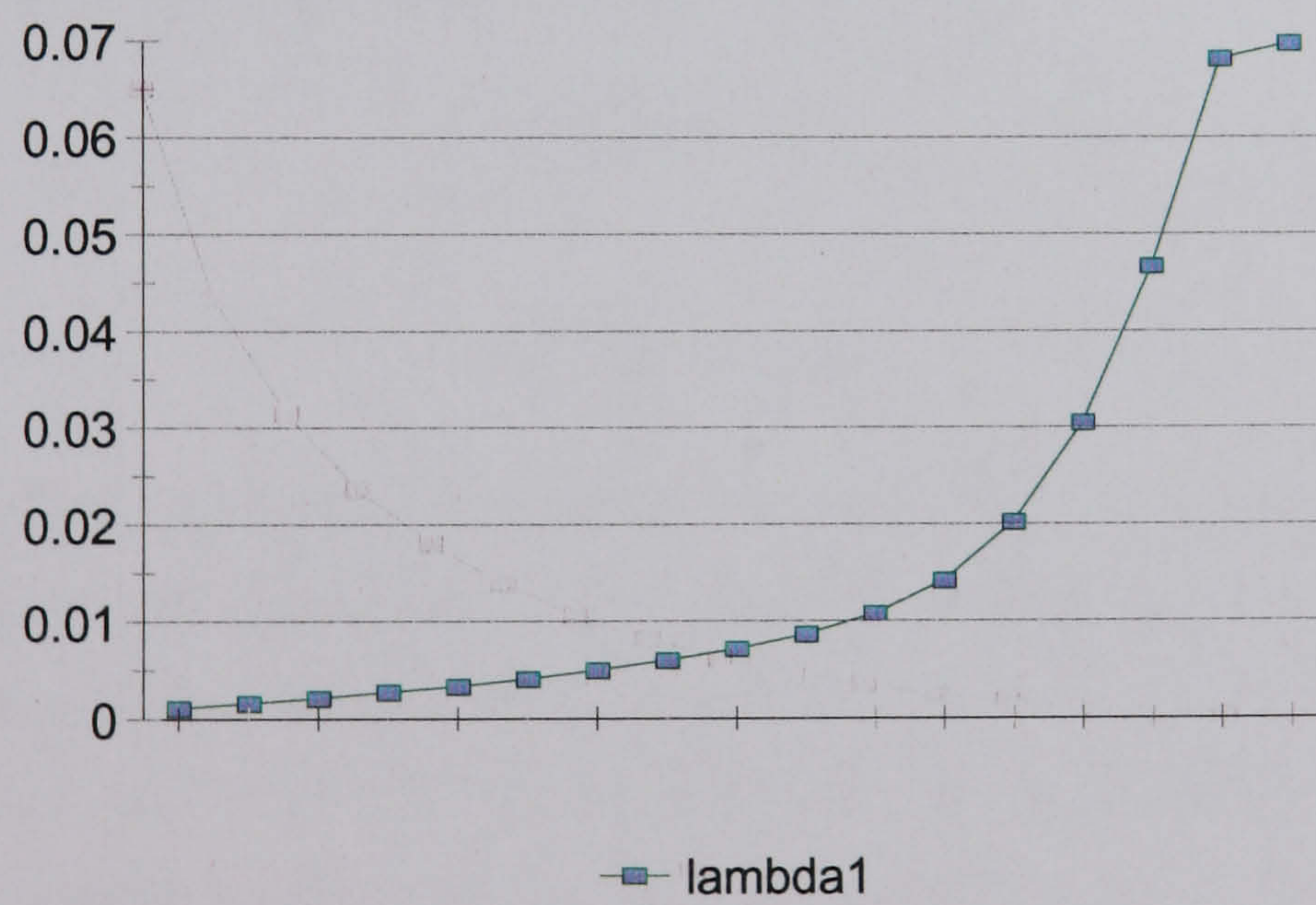

Figure 39: Time behaviour of  $\lambda_1$  for  $\lambda_1(0) = 0.001$



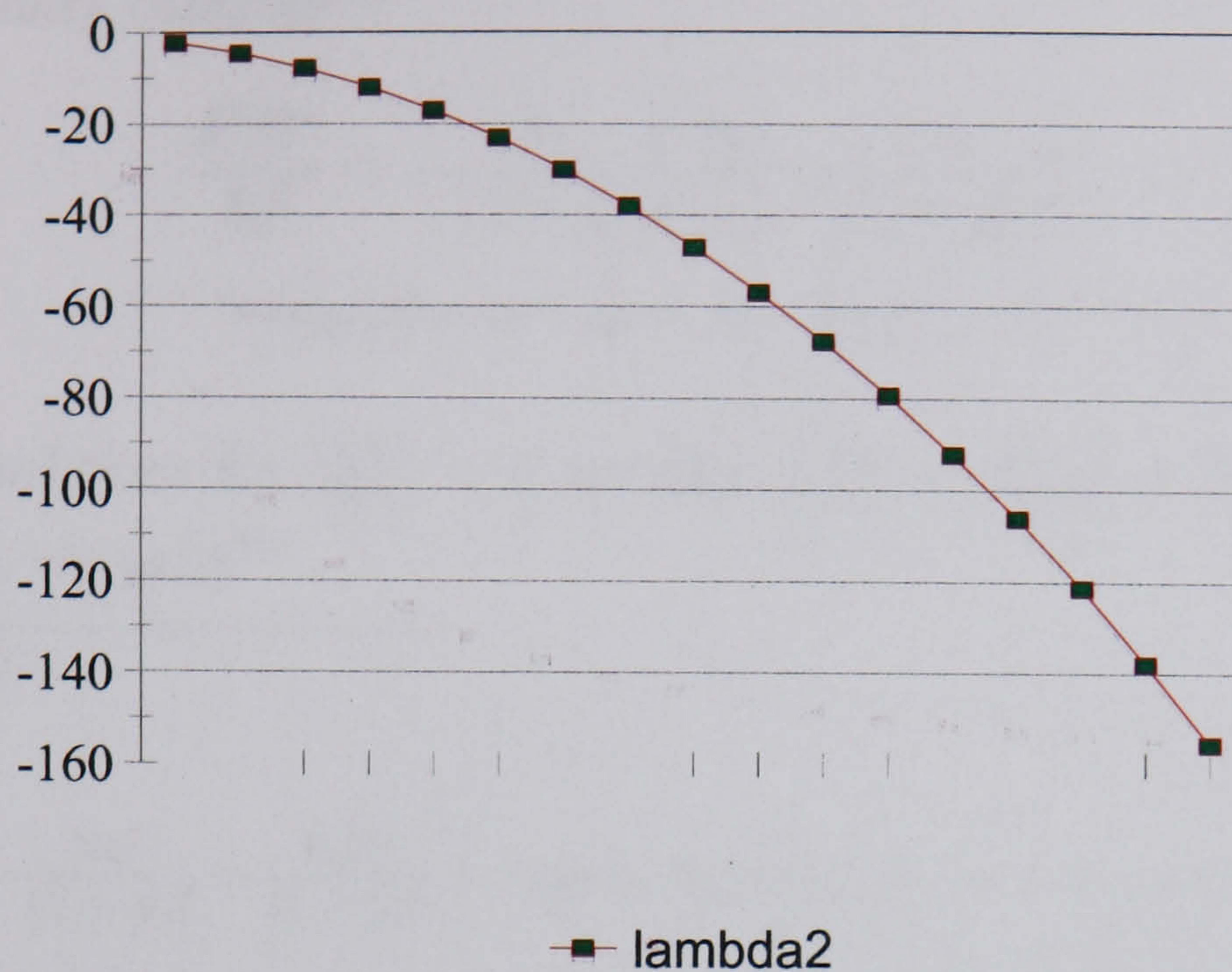

Figure 40: Time behaviour of  $\lambda_2$  for  $\lambda_2(0) = -2.06$

capital per healthy worker ratio,  $z$ . At first we analyse the case with a finite time horizon and nonnegative terminal constraints on the state variables. Specifically, for (212) the transversality conditions

$$\lambda_1(T)z(T) = 0 \quad (230)$$

$$\lambda_2(T)p(T) = 0 \quad (231)$$

form part of the necessary conditions for optimality. As in Section 4.3.4 if the conditions of Mangasarian Theorem are satisfied, then the necessary conditions for optimal control using the maximum principle's necessary conditions are also sufficient.<sup>249</sup> Specifically, any path satisfying the necessary conditions is optimal when the maximised Hamiltonian is concave (and differentiable) in the state variables  $p$  and  $z$ . The maximised Hamiltonian is concave at least over a compact set covering the steady states and the asso-

<sup>249</sup>Chiang, 1992; Mangasarian, 1966.



ciated stationary controls<sup>250</sup>

$$\begin{aligned} \frac{\delta^2 H^*}{\delta p^2} = & -\frac{\lambda_1}{(1+p)} \left( \frac{u_1}{u_{11}} + \frac{2\beta z}{(1+p)} \right) \\ & + u_{22} (\beta - \alpha - \omega - \rho - 2\rho p)^2 < 0 \end{aligned} \quad (232)$$

Sufficient conditions for  $\frac{\delta^2 H^*}{\delta p^2} < 0$  are that  $\left( \frac{u_1}{u_{11}} + \frac{2\beta z}{(1+p)} \right) > 0$  and  $u_{22} < 0$ . Furthermore, we need<sup>251</sup>

---

<sup>250</sup>From (216)

$$\frac{\delta H}{\delta p} = -\frac{u_1 c}{(1+p)^2} + \frac{\lambda_1 \beta z}{(1+p)^2} - \lambda_1 \rho z + (\lambda_2 + u_2) (\beta - \alpha - \omega - \rho - 2\rho p) \quad (f85)$$

we have

$$\frac{\delta^2 H}{\delta p^2} = \frac{u_1 c}{(1+p)^3} - \frac{u_1 \frac{\delta c}{\delta p}}{(1+p)^2} - \frac{2\lambda_1 \beta z}{(1+p)^3} + u_{22} (\beta - \alpha - \omega - \rho - 2\rho p)^2 \quad (f86)$$

with

$$\frac{\delta c}{\delta p} = \frac{\lambda_1 (1+p)}{u_{11}} + \frac{c}{(1+p)} \quad (f87)$$

so that (f87) becomes

$$\frac{u_1 c}{(1+p)^3} - \frac{u_1}{(1+p)^2} \left[ \frac{\lambda_1 (1+p)}{u_{11}} + \frac{c}{(1+p)} \right] - \frac{2\lambda_1 \beta z}{(1+p)^3} + u_{22} (\beta - \alpha - \omega - \rho - 2\rho p)^2 \quad (f88)$$

or

$$\frac{u_1 c}{(1+p)^3} - \frac{u_1 \lambda_1}{u_{11} (1+p)} - \frac{u_1 c}{(1+p)^3} - \frac{2\lambda_1 \beta z}{(1+p)^3} + u_{22} (\beta - \alpha - \omega - \rho - 2\rho p)^2 \quad (f89)$$

and eventually

$$-\frac{\lambda_1}{(1+p)} \left[ \frac{u_1}{u_{11}} + \frac{2z\beta}{(1+p)^2} \right] + u_{22} (\beta - \alpha - \omega - \rho - 2\rho p)^2 \quad (f90)$$

<sup>251</sup>From (215)



$$\begin{aligned} \frac{\delta^2 H^*}{\delta z^2} = & -\lambda_1 \left[ z \left( \alpha'' - \beta'' \frac{p}{(1+p)} + \rho'' p \right) + 2 \left( \alpha' - \beta' \frac{p}{(1+p)} + \rho' p \right) \right] \\ & + (\lambda_2 + u_2) [(\beta'' - \alpha'' - \omega'' - \rho'') p - \rho'' p^2] \\ & + u_{22} [(\beta' - \alpha' - \omega' - \rho') p - \rho' p^2]^2 < 0 \end{aligned} \quad (233)$$

which is negative if

$$\lambda_2(t) < 0 \quad (234)$$

$$\left[ z \left( \alpha'' - \beta'' \frac{p}{(1+p)} + \rho'' p \right) + 2 \left( \alpha' - \beta' \frac{p}{(1+p)} + \rho' p \right) \right] > 0 \quad (235)$$

$$\begin{aligned} \frac{\delta H}{\delta z} = & -\lambda_1 \{ f\phi + [\alpha - \beta p/(1+p) + \rho p] + z [\alpha' - \beta' p/(1+p) + \rho' p] \} \\ & + (\lambda_2 + u_2) [(\beta' - \alpha' - \omega' - \rho') p - \rho' p^2] \end{aligned} \quad (f91)$$

we have

$$\begin{aligned} \frac{\delta^2 H}{\delta z^2} = & -\lambda_1 \{ 2 [\alpha - \beta p/(1+p) + \rho p] - z [\alpha'' - \beta'' p/(1+p) + \rho'' p] \} \\ & + (\lambda_2 + u_2) [(\beta'' - \alpha'' - \omega'' - \rho'') p - \rho'' p^2] \\ & + u_{22} [(\beta' - \alpha' - \omega' - \rho') p - \rho' p^2] \frac{\delta \dot{p}}{\delta p} \end{aligned} \quad (f92)$$

where

$$\frac{\delta \dot{p}}{\delta p} = [(\beta' - \alpha' - \omega' - \rho') p - \rho' p^2] \quad (f93)$$

so that (233) becomes

$$\begin{aligned} \frac{\delta^2 H}{\delta z^2} = & -\lambda_1 \{ 2 [\alpha - \beta p/(1+p) + \rho p] - z [\alpha'' - \beta'' p/(1+p) + \rho'' p] \} \\ & + (\lambda_2 + u_2) [(\beta'' - \alpha'' - \omega'' - \rho'') p - \rho'' p^2] \\ & + u_{22} [(\beta' - \alpha' - \omega' - \rho') p - \rho' p^2]^2 \end{aligned} \quad (f94)$$



$$[(\beta'' - \alpha'' - \omega'' - \rho'')p - \rho''p^2] > 0 \quad (236)$$

and

$$\rho'' < 0 \quad (237)$$

There is nothing in the theory to constrain the sign of  $\lambda_2(t)$ . However, as  $\lambda_2(t)$  represents the shadow price of a marginal increase in the TB prevalence of the disease, we expect  $\lambda_2(t)$  to be negative. A further condition to be fulfilled is

$$\left(\frac{\delta^2 H^*}{\delta p^2}\right) \left(\frac{\delta^2 H^*}{\delta z^2}\right) - \left(\frac{\delta^2 H^*}{\delta p \delta z}\right) > 0 \quad (238)$$

where<sup>252</sup>

---

<sup>252</sup>From (216)

$$\frac{\delta H}{\delta p} = -\frac{u_1 c}{(1+p)^2} + \frac{\lambda_1 \beta z}{(1+p)^2} - \lambda_{1\rho z} + (\lambda_2 + u_2)(\beta - \alpha - \omega - \rho - 2\rho p) \quad (f95)$$

we have that

$$\begin{aligned} \frac{\delta^2 H}{\delta p \delta z} &= \frac{\lambda_1}{(1+p)^2} (\beta + \beta' z) - \lambda_1(\rho + \rho' z) + (\lambda_2 + u_2)(\beta' - \alpha' - \omega' - \rho' - 2\rho' p) \\ &\quad + u_{22}(\beta - \alpha - \omega - \rho - 2\rho p) \frac{\delta \dot{p}}{\delta z} \end{aligned} \quad (f96)$$

with

$$\frac{\delta \dot{p}}{\delta z} = [(\beta' - \alpha' - \omega' - \rho')p - \rho'p^2] \quad (f97)$$

so that (239) becomes

$$\begin{aligned} \frac{\delta^2 H}{\delta p \delta z} &= \frac{\lambda_1}{(1+p)^2} (\beta + \beta' z) - \lambda_1(\rho + \rho' z) + (\lambda_2 + u_2)(\beta' - \alpha' - \omega' - \rho' - 2\rho' p) \\ &\quad + u_{22}(\beta - \alpha - \omega - \rho - 2\rho p) [(\beta' - \alpha' - \omega' - \rho')p - \rho'p^2] \end{aligned} \quad (f98)$$



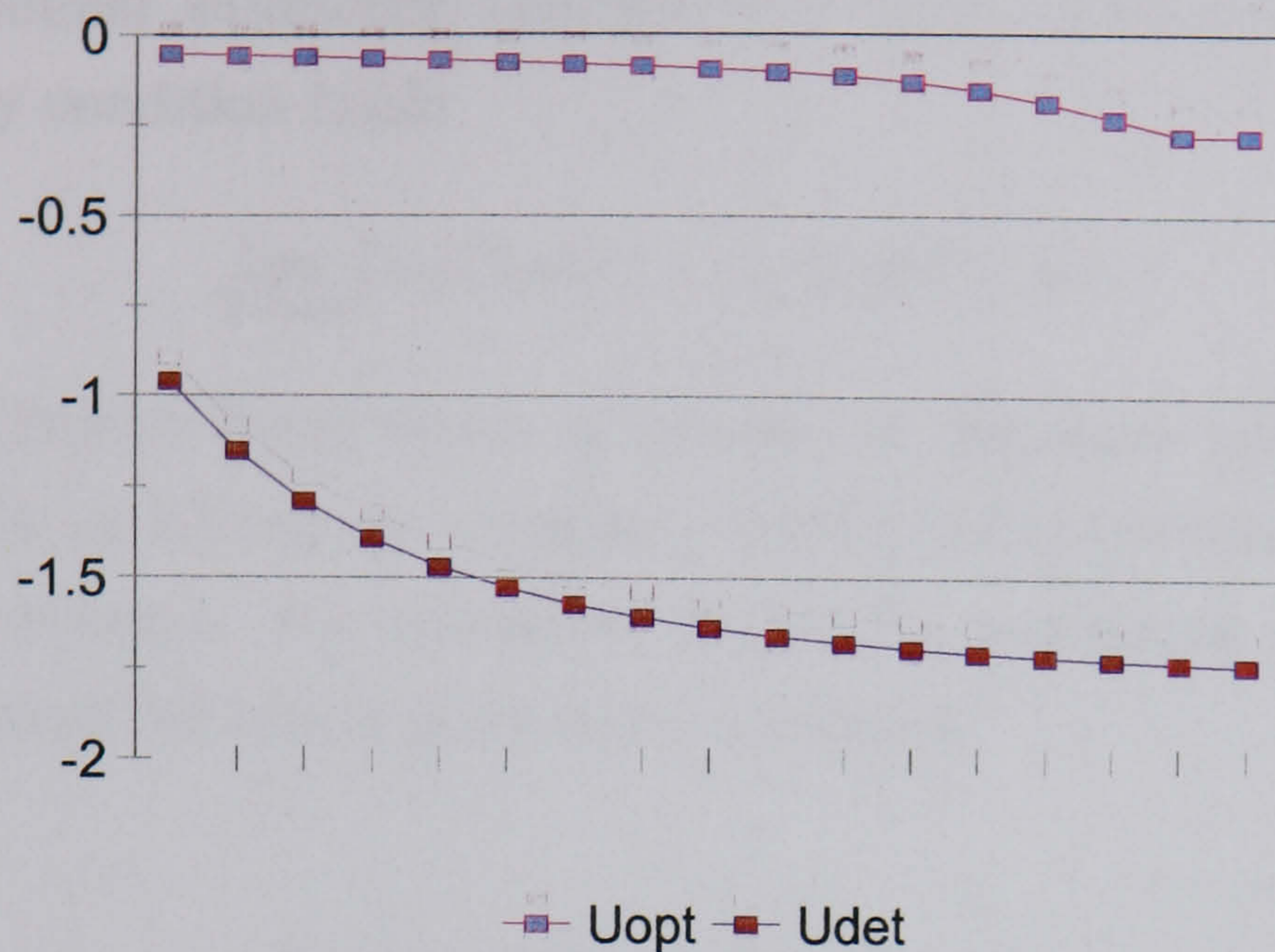

Figure 41: Per period utility on the deterministic and optimal paths

$$\begin{aligned}
\frac{\delta^2 H^*}{\delta p \delta z} = & \frac{\lambda_1}{(1+p)^2} (\beta + z\beta') - \lambda_1(\rho + \rho'z) \\
& + (\lambda_2 + u_2) (\beta' - \alpha' - \omega' - \rho' - 2\rho'p) \\
& + u_{22} (\beta - \alpha - \omega - \rho - 2\rho p) [(\beta' - \alpha' - \omega' - \rho') p - \rho'p^2] \quad (239)
\end{aligned}$$

Given the high complexity of these conditions we choose to check conditions (232)-(233)-(238) numerically on the solution paths. With initial conditions

$$[p(0) = 1.29, \quad z(0) = 60.27, \quad \lambda_1(0) = 0.001, \quad \lambda_2(0) = -2.06] \quad (240)$$

the sufficient conditions for concavity are fulfilled for the finite horizon optimal paths we take. For (240), the conditions (232), (233) and (238) are satisfied with  $\frac{\delta^2 H^*}{\delta p \delta z} < 0$ . Furthermore, as expected, for any  $t$  the level of per period utility and the integral of period utility are higher on the optimal path than on the deterministic one (Fig. 41).

For the case when the time horizon is infinite then the transversality conditions are not generally necessary. However, as in Section 4.3.4 an adap-



tation of a similar sufficiency theorem<sup>253</sup> is used. Specifically, if a form of transversality condition holds

$$\lim_{T \rightarrow \infty} [\lambda_1(T)z(T) + \lambda_2(T)p(T)] \leq 0 \quad (241)$$

and the maximized Hamiltonian is concave in the state variables  $p$  and  $z$  then any path satisfying the necessary conditions is optimal according to the catching-up criterion. For optimality under the overtaking criterion, (241) needs to be modified into a more strict condition

$$[\lambda_1(T)z(T) + \lambda_2(T)p(T)] = 0 \quad (242)$$

## 5.5 Summary

By allowing for individuals to receive effective TB treatment and be cured in the demographic-epidemiological framework, a steady state exists only when the TB transmission coefficient is greater than the sum of the net growth rate of the susceptible individuals, the total death rate of the TB infected people and the recovery rate ( $\beta - \alpha - \omega - \rho > 0$ ). Two different dynamics are possible. As  $t$  tends to infinity, either the population decays to zero with an asymptotic constant TB prevalence when  $(\omega + \alpha)(\omega + \rho) - \beta\omega < 0$  or there is equiproportional growth of both healthy and infected again with asymptotic constant TB prevalence when  $(\omega + \alpha)(\omega + \rho) - \beta\omega > 0$ . When there is no balanced growth path the disease is eliminated ( $\beta - \alpha - \omega - \rho < 0$ ) with the TB infected dying out and the healthy growing at an asymptotically constant rate. Given the data available, only the case of balanced decrease in the population can be reproduced with data from the Western Pacific Region. Here population falls at 3 per cent per period and asymptotically 70 per cent of the population is infected. At first sight this is unrealistic but recall that this is a pure demographic-epidemiological model without any health control effects; so we move to integrate it with the economics.

---

<sup>253</sup>Theorem 9.3.1 in Leonard and Long, (1992).



The two way linkage between TB and the economic system here is also considered in a setting where the demographic-epidemiological parameters are functions of specific public health infrastructure investment. Firstly, we examine the case where the individuals have access to effective TB treatment. We find that analytically the number of steady states is ambiguous and so we calibrate the model on data from the Region of Americas and the South East Asia Region. For this data we find that there are two steady states. The first, characterised by local partial instability (saddle point), presents a zero level of TB prevalence for a positive level of public health investment. The dynamics around the second steady state is characterised by local stability. However, for the same demographic-epidemiological structure but with different values for the savings rate and the scale of output there is only one steady state.

As public health infrastructure investment does not always imply TB infected individuals can be treated and efficiently cured, next we consider the case where output can be either consumed or invested in targeted public health infrastructure but TB treatment is inefficient and therefore negligible. Three different dynamics are possible. We can have a case characterised by two steady states (one saddle point and one stable node) where the system settles down to an economic-epidemiological steady state with positive level of public health investment and a constant population structure of susceptible and TB infected people. The second case is characterised by only one steady state which is a stable node. Here the disease has been eradicated and a positive level of public health investment exists. The lack of concavity of the technology and its linearity imply that the  $\dot{p} = 0$  and  $\dot{z} = 0$  loci may not intersect generating a third dynamic pattern with a single steady state. This steady state is a saddle point where  $p$  is unstable and  $z$  has some directions of stability. For our calibration we selected data from the Region of Americas and the South-East Asia Region which represent the high and low capital countries, respectively. By choosing three alternative values for the savings rate, we were able to reproduce the three possible different dynamic patterns. Our results confirm the important role of the savings rate



is allowing sustainability of the population and the control or eradication of the disease. The main effect of considering also the economic dimension by assuming the demographic-epidemiological parameters to be functions of public health investment, is that multiple steady states are possible and that around any of the steady state the time path of TB prevalence is not monotone.

Next we consider a central planner facing a TB epidemic with the possibility of providing effective TB treatment and who chooses his actions so that the division of output between consumption and public health investment is set to maximise social welfare. The global dynamics of this model is potentially rich. A clear feature is that, because of the nature of technology, it cannot have a steady state with eradication of the disease. Using data from the Region of Americas and the South-East Asian Region we quantify the steady state(s) and optimal dynamic growth paths. We find that there is a single steady state in which 12 per cent of the population is infected and the capital per healthy worker is close to unity. This steady state is a 4-D saddle point. We give examples of finite horizon optimal growth paths in which the capital per healthy worker and the TB prevalence both fall. Each of these variables monotonically decreases over time while the shadow price of the capital per healthy worker and TB prevalence monotonically increase with time. Note that for the finite horizon the transversality conditions hold on these paths. In these calibrated examples there are no cycles but rather monotone convergence.



## 6 Conclusions

Infectious diseases have long been identified as a main cause of mortality in human population. To date, although some of these diseases have been completely eradicated or kept at an endemic level in the population, in many parts of the world the exacerbation of old infections or the emergence of new ones are having dramatic effects on the population with strong repercussions on the economic structure.

As reported by the World Health Organization, since the early 1980s TB has been the major health problem in developing countries, with about two million cases of death each year. There are three main factors that have led to the recent TB or MDR-TB epidemics in many developing countries: the spread of HIV/AIDS infection, the increasing movements of people across countries and poverty, malnutrition, overcrowded housing together with poor hygienic conditions associated with rapidly increasing urbanization.

The currently available international strategies for controlling the recent TB epidemic are targeted bio-medical interventions such as Direct Observed Therapy Strategy (DOTS) and isolation of TB infected individuals. However, empirical evidence suggests that isolation may lead to 'epidemiological injustice'<sup>254</sup> in that the high-density TB levels in segregated areas increase the probability of transmission within the isolated group. Furthermore, the current bio-medical TB treatment strategies are not widely accessible and they are characterised by a low level of compliance due to lack of operation or infrastructure of public health services. Moreover, empirical evidence indicates that factors such as behaviour, the environment and socio-economic status are important elements affecting people's health. The increase in reported TB cases and the rise in MDR-TB has been shown to reflect a larger picture of poverty, deteriorating inner cities, substance abuse and homelessness which complicates the formulation and implementation of public health TB control measures.<sup>255</sup>

---

<sup>254</sup>Acevedo-Garcia, 2000.

<sup>255</sup>Brudney and Dobkin, 1991; Gittler, 1994; Reichman, 1991.



In this work we argue that relying exclusively on the current targeted bio-medical strategy is an inadequate approach to the lasting control of TB. Diseases such as TB are indicators of wider social, environmental and global conditions and they must be seen within a wider concept of health. A more complex and interdisciplinary model integrating the contributing factors for the TB epidemic is needed.

Most of the research has failed to analyse the complex quality of the recent TB and MDR-TB epidemics. Epidemiological contributions generally limit the analysis of the dynamics of the infectious diseases to their effects on the population structure. The economic literature focuses on the impacts of economic variables on population growth and quality.

In the present work, in order to sharpen the current understanding of the TB transmission dynamics, we analyse different scenarios where only demographic and epidemiological elements are considered. We refer to a predator-prey Lotka-Volterra type framework where TB infected individuals act as predators of susceptible preys. In particular, at first we provide a simple demographic-epidemiological model where a population is composed of susceptible and TB infected individuals. When susceptible, an individual can either become infected or remain susceptible. Once infected, an individual can remain infected or die because of TB or causes other than TB. Subsequently, density dependence effects and the role of recovery are included into the analytical framework. Referring back to the outstanding issues which motivated the thesis (p. 10) our first finding is that, when only demographic-epidemiological factors are considered, the resulting overall dynamic patterns are of a "bang-bang" type: TB prevalence either rises exponentially so that, as  $t \rightarrow \infty$ , the whole population is extinct or, as  $t \rightarrow \infty$ , approaches to zero so that the disease is eradicated. The inclusion of the possibility of recovery does not affect the "bang-bang" nature of the dynamics. An alternative result is obtained when the density dependence effects are considered. In this case, the demographic-epidemiological system is characterised by the same dynamical properties as the predator-prey Lotka-Volterra type model.



Specifically, together with the possibility of a "bang-bang" solution as previously described, here the number of susceptible and TB actively infected individuals can exhibit periodic behaviour around a stationary state with a positive number of both susceptible and infected people. As the system has an equilibrium solution being a centre, positive equilibrium values are never approached. This case excludes the possibility for an infectious disease to be eradicated or to show an explosive behaviour. However, the overall population exhibits no trend growth.

As diseases like TB have been reported to be a reflection of underlying social conditions of poverty and lack of public health infrastructures/services, an integrated approach, taking into account demographic-epidemiological and socio-economic level of causality is required.

To the state of our knowledge, the present work is the first to provide a general analytic framework which captures all the relevant interactions between the spread of infectious disease and the economic system.

As empirical evidence suggests that general prosperity, by bringing improvements in housing and working conditions, diet, transport and health infrastructure, affects the demographic-epidemiological fluctuations, the demographic and epidemiological parameters are first considered to be function of economic prosperity here proxied by capital per healthy labour worker. Furthermore, as empirical works recorded that improvements in the basic health infrastructure (e.g. hospitals, medical equipment, transport and supplies) are believed to favour the decline of TB morbidity/mortality rates and hence reduce the source of new TB infections, demographic-epidemiological factors are alternatively taken to be a function of public health investment.

Overall, by adding the economic dimension to the demographic-epidemiological process we find that the dynamics are characterised by multiple equilibria. Generally, there is an equilibrium point with a zero level of TB prevalence for a positive level of productive capital/public health investment. As TB is partially a function of the general level of prosperity/public health investment, it is possible to determine the conditions, expressed in terms of



demographic-epidemiological parameters, for which economic growth/public health investment can drive the TB prevalence towards zero. Furthermore, for a specific set of initial conditions the system settles down to an economic-epidemiological equilibrium point with a positive level of economic prosperity/public health investment and a constant population structure of susceptible and TB infected people. Only for the case where the factors are functions of productive capital the system exhibits also an unstable steady state where the economy is irrelevant and the population has been driven to extinction. In the case where the density dependent effects are not included in the analysis the system is characterised by balanced growth path. By allowing for density dependence effects only a partially balanced growth path exists. Here, for initial conditions starting on the partially balanced growth path the disease cannot break out; for initial conditions starting away from it the disease cannot be eradicated. By allowing for TB infected individuals to receive effective treatment where the demographic-epidemiological factors are functions of public health investment, the overall dynamics is not altered.

Next we consider optimal dynamic policy where the savings rate is selected to optimise an intertemporal welfare function which depends on the population structure and on consumption per capita. Given the intractability of the analytical results, we investigate the overall dynamics by the means of calibration. We find that both in the case when the demographic-epidemiological factors are functions of productive capital and in the case in which they are functions of public health investment, the system is characterised by one steady state in which there is a positive level of both productive capital/public health investment and its shadow price. When capital per healthy worker is considered, as  $t \rightarrow \infty$ , on the optimal paths TB prevalence falls continuously towards zero; in the public health investment case, it also falls continuously. Overall, our theoretical analysis, supported by numerical calibrations for an observed benchmark data set, provides insights about the long-run consequences of different interactions between population growth, TB epidemic and the economic system. In particular, our results indicate



the crucial role of optimally determined savings in allowing, in the short-run, for an increase in the level of economic prosperity/public health investment and, consequently, in the long-run, for the eradication/control of the disease.

Although the analytical frameworks provided in this study have characteristics which are sufficiently realistic for useful results to be obtained, overall, the present work suggests issues, not investigated here, about the TB epidemic and the economy interdependence, which deserve to be considered further. The models presented so far might provide, however, the basis of various extensions.

First, more emphasis should be given to TB preventive policy. Specifically, analysis should focus on the impact on TB prevalence of a pro/countercyclical vaccination policy both in a central planner context and under a decentralised control.

Second, as empirical evidence suggests that the demographic-epidemiological parameters are age-dependent, an economic-epidemiological age-structure model should be developed. Furthermore, given that to different TB prevalence levels lead to different individual attitude towards exposure and protection, the TB transmission rate should be considered to be a function of the number of TB infected people divided the number of susceptible population.

Third, the impact of the latent infections (infected-but-not-yet-infectious) and the possibility of TB vertical transmission (i.e. some are born TB infected) on the overall TB dynamics requires to be investigated.

Fourth, spatial patterns (e.g. spread of disease following the outer surface of an already infected geographic 'epicenter') need to be analysed taking into consideration both hierarchical and network diffusion. The former refer to the spread of infectious diseases from larger or more socially dominant communities to smaller places, generally via the transport network (e.g. two distant cities can be very close together in 'transport space' when there is a high frequency of movement between them). The latter indicate a rate of intragroup disease transmission (i.e. personal, domestic social network)



higher than the intergroup one.

Fifth, as the global resurgence of TB is being accelerated by the spread of HIV/AIDS epidemics,<sup>256</sup> the dynamic analysis should be reframed to capture the self-reinforcing impact of HIV/AIDS epidemic.

Sixth, in view of the active role played by the increasing number of migrants in the diffusion of TB, a two region economic-epidemiological model should be developed. The policy implications of a migration phenomenon as simultaneously determined by economic opportunities and health related factors are interesting and an important topic for future research.

Seventhly, South-Africa has been reported to be afflicted by one of the worst TB epidemics in the world with disease rates up to sixty times those of United States or Western Europe and more than double those observed in other developing countries.<sup>257</sup> Given the failure of the bio-medical TB control policy implemented since 1996 (i.e. DOTS) due to a high non-compliance rate, the serious impact of HIV/AIDS and the urban-rural migration phenomenon. an extensive applied research is required to capture the complex socio-economic dimension of the problem. An integrated approach in TB control, taking into account demographic-epidemiological and socio-economic level of causality, combining prevention and treatment, could produce more effective interventions for the long-lasting control of the disease.

Eighthly, stochastic elements of the disease transmission process are important but have been neglected here as have been stochastic aspects of technology or of the birth/death rates. In reality chance events displace the model parameters.

Lastly, the influence of environmental variables on the disease transmission process and the health structure of the population have been ignored. This should be investigated as a matter of priority.

---

<sup>256</sup>HIV infection has been estimated to annually produce at least 1.4 million active cases of TB that otherwise would have not occurred. Furthermore, TB is the leading cause of mortality among people who are HIV-positive accounting for almost one third of deaths world-wide. WHO, 2000c.

<sup>257</sup>Fourie and Weyer, 1996.



## A Appendix

### A.1 Linearization around the First Stationary Point in the Economic-Epidemiological Prototype Model

By using a similarity transformation<sup>258</sup> it is possible to show that the  $J$  and  $E$  matrices have the same eigenvalues as there is a nonsingular matrix  $G$  such that  $E = G^{-1}JG$  where

$$E = \begin{bmatrix} 0 & -\alpha\omega & -\alpha\omega \left( \frac{\beta'}{\beta} - \frac{\omega'}{\omega} \right) \\ 1 & 0 & \alpha \left( \frac{\alpha'}{\alpha} - \frac{\beta'}{\beta} \right) \\ -\frac{k}{x} & 0 & sF_k - \phi - \alpha \frac{k}{x} \left( \frac{\alpha'}{\alpha} - \frac{\beta'}{\beta} \right) \end{bmatrix} = \begin{bmatrix} 0 & -\alpha\omega & b_{13} \\ 1 & 0 & b_{23} \\ -\frac{k}{x} & 0 & b_{33} \end{bmatrix} \quad (243)$$

and

$$G = \begin{bmatrix} 0 & 1 & 0 \\ -\frac{1}{\omega} & 0 & 0 \\ 0 & \frac{k}{x} & 1 \end{bmatrix} \quad (244)$$

$$G^{-1} = \begin{bmatrix} 0 & -\omega & 0 \\ 1 & 0 & 0 \\ -\frac{k}{x} & 0 & 1 \end{bmatrix} \quad (245)$$

Under the assumption that  $\alpha' \left( \frac{y(t)}{x(t)} \right) > 0$ ,  $b_{13}$  has an ambiguous sign while  $b_{23} < 0$  and  $b_{33} < 0$ . The characteristic equation of  $E$  is given by

$$v(\eta) = -\eta^3 + b_{33}\eta^2 - \left( \frac{k}{x}b_{13} + \alpha\omega \right) \eta + \alpha\omega \left( b_{33} + \frac{k}{x}b_{23} \right) \quad (246)$$

---

<sup>258</sup>If there exists a nonsingular matrix  $G$  such that  $E = GJG^{-1}$ , the square matrices  $J$  and  $E$  are said to be similar. It follows that similar matrices have the same characteristic polynomial. Hadley, 1961.



For simplicity in what follows we use the cubic equation

$$\varsigma(\eta) = -v(\eta) = \eta^3 - b_{33}\eta^2 + \left(\frac{k}{x}b_{13} + \alpha\omega\right)\eta - \alpha\omega\left(b_{33} + \frac{k}{x}b_{23}\right) = 0 \quad (247)$$

As  $\lim_{\eta \rightarrow 0} \varsigma(\eta) = -\alpha\omega\left(b_{33} + \frac{k}{x}b_{23}\right) = sf_k - \phi < 0$ , there are no zero real roots. As the turning points<sup>259</sup> are at

$$\eta_{+,-} = \frac{1}{3} \left[ b_{33} \pm \sqrt{b_{33}^2 - 3\frac{k}{x}b_{13} - 3\alpha\omega} \right] \quad (248)$$

for  $b_{33}^2 - 3\frac{k}{x}b_{13} - 3\alpha\omega \leq 0$ ,  $\varsigma(\eta)$  has either no turning points or only a point of inflection. Furthermore, as  $\lim_{\eta \rightarrow \pm\infty} \varsigma(\eta) = \pm\infty$ ,  $\varsigma(\eta)$  is always increasing hence giving a single real root and a pair of complex conjugate roots. As from (243)  $b_{33} = sf_k - \phi - \alpha\frac{k}{x}\left(\frac{\alpha'}{\alpha} - \frac{\beta'}{\beta}\right)$  and  $b_{13} = -\alpha\omega\left(\frac{\beta'}{\beta} - \frac{\omega'}{\omega}\right)$ , then

$$\begin{aligned} b_{33}^2 - 3\left(\frac{k}{x}b_{13} + \alpha\omega\right) &= \left[ sf_k - \phi - \frac{k}{x}\left(\frac{\alpha'}{\alpha} - \frac{\beta'}{\beta}\right)\alpha \right]^2 \\ &\quad + 3\alpha\omega \left[ \frac{k}{x}\left(\frac{\beta'}{\beta} - \frac{\omega'}{\omega}\right) - 1 \right] \end{aligned} \quad (249)$$

from which it follows that the single real root is negative for  $\frac{k}{x}\left(\frac{\beta'}{\beta} - \frac{\omega'}{\omega}\right) - 1$  being sufficiently negative leading to a focus sink (positive or negative attractor). For  $b_{33}^2 - 3\left(\frac{k}{x}b_{13} + \alpha\omega\right) > 0$ , then there are two turning points,  $\eta_+$  and  $\eta_-$ , with  $\eta_+ > \eta_-$ . By assuming  $\alpha' \left(\frac{k(t)}{x(t)}\right) > 0$ , from (248) we know that  $\eta_- < 0$  as  $b_{33} < 0$  and the derivative of the  $\varsigma(\eta)$  is a quadratic with a minimum at  $\eta = b_{33}/3 < 0$ . Furthermore,  $\varsigma(\eta)$  is decreasing between its turning points when  $\varsigma(\eta_+) \leq \varsigma(\eta_-)$ . If  $\varsigma(\eta_+) \varsigma(\eta_-) > 0$ , for

$$\left[ b_{33} \left( -2b_{33}^2 + 9b_{13}\frac{k}{x} \right) - 9 \left( 2b_{33} + 3\frac{k}{x}b_{23} \right) \alpha\omega \right]^2 > \left( b_{33}^2 - 3 \left( \frac{k}{x}b_{13} + \alpha\omega \right) \right)^3 \quad (250)$$

---

<sup>259</sup>From (247) we know that

$$\varsigma'(\mu) = 3\mu^2 - 2b_{33}\mu + \frac{k}{x}b_{13} + \alpha\omega \quad (f99)$$

The solution to (f99) are as in (248).



the characteristic equation does not change sign between its turning points and we have a negative single real root and a pair of complex conjugate roots leading to a focus sink (positive or negative attractor). However, if  $\varsigma(\eta)$  does change sign between its turning points from positive at  $\eta_-$  to negative at  $\eta_+$ , then there are three negative real roots (if  $\eta_+ < 0$ ) leading to a 3-D node (positive attractor) or two positive and one negative real root (if  $\eta_+ > 0$ ) leading to a saddle point with a stable direction. The condition for  $\eta_+ > 0$  is that  $b_{13}\frac{k}{x} + \alpha\omega < 0$ . Under the assumption that  $\alpha' \left( \frac{k(t)}{x(t)} \right) < 0$  it is possible that  $b_{33} > 0$ , then when there are two turning points we know that  $\eta_+ > 0$  since  $\eta_+$  is greater than the value of  $\eta$  that minimises the slope of the cubic (at  $b_{33}/3$ ). As before it follows that there are either a single negative real root and a pair of complex conjugate roots or two positive and one negative real roots.

## A.2 Linearization around the Third Stationary Point in the Economic-Epidemiological Prototype Model

Specifically, (65) gives real roots if

$$[\alpha - sF_k - \phi]^2 + 4sF_x\alpha' - 4sF_k\phi + 4\alpha\phi \geq 0 \quad (251)$$

By assuming  $\alpha' \left( \frac{k(t)}{x(t)} \right) > 0$  and  $(sF_k - \phi) > 0$  for  $k^* = 0$  we have

$$\begin{aligned} [\alpha - sF_k - \phi]^2 + 4sF_x\alpha' - 4sF_k\phi + 4\alpha\phi &> \\ [\alpha - sF_k - \phi]^2 &\geq 0 \end{aligned} \quad (252)$$

From (65) we know that

$$\frac{1}{2} [\alpha + sF_k - \phi + \alpha - sF_k - \phi] = \frac{1}{2} [2\alpha - 2\phi] = (\alpha - \phi) \quad (253)$$



so that one<sup>260</sup> of the roots in (65) is greater than  $(\alpha - \phi)$ .

Furthermore, from (65) we also know that

$$\frac{1}{2} [\alpha + sF_k - \phi - \alpha + sF_k + \phi] = sF_k \quad (254)$$

From (254) it follows that the other root<sup>261</sup> is less than  $sF_k$  and nonnegative.

Conclusively, if  $\alpha < \phi$ , both  $\eta_1$  and  $\eta_2$  are negative. For  $\alpha > \phi$ , while we know that  $\eta_1 = \frac{1}{2} \left\{ [\alpha + sF_k - \phi] + \sqrt{[\alpha - sF_k - \phi]^2 + 4sF_x\alpha'} \right\}$  is positive, the sign of  $\eta_2 = \frac{1}{2} \left\{ [\alpha + sF_k - \phi] - \sqrt{[\alpha - sF_k - \phi]^2 + 4sF_x\alpha'} \right\}$  is ambiguous.

### A.3 The Jacobian for the Centrally Planned Productive Model

Linearising the dynamic equations (117)-(211)-(122)-(123) gives the Jacobian of

$$\begin{aligned} {}^{260}\eta_1 &= \frac{1}{2} \left\{ [\alpha + sF_k - \phi] + \sqrt{[\alpha - sF_k - \phi]^2 + 4sF_x\alpha'} \right\} \\ {}^{261}\eta_2 &= \frac{1}{2} \left\{ [\alpha + sF_k - \phi] - \sqrt{[\alpha - sF_k - \phi]^2 + 4sF_x\alpha'} \right\} \end{aligned}$$



$$\left[ \begin{array}{ccc}
 (\beta - \alpha - \omega) & P(\beta - \alpha - \omega)' & 0 \\
 \frac{2\beta}{(1+P)^2} - \frac{k}{\beta} & f' - \phi - (\alpha - \beta) \frac{P}{(1+P)} & 0 \\
 -\frac{\lambda_1}{(1+P)^2} (\beta + Z\beta) - \lambda_2 (\beta - \alpha - \omega)' & -Z(\alpha - \beta) \frac{P}{(1+P)} & -\frac{\delta c}{\delta \lambda_1} \\
 \frac{\delta(u_1 c)}{\delta P} \frac{1}{(1+P)^2} & -\lambda_1 [f' - 2(\alpha - \beta) \frac{P}{(1+P)}] & -(f' - (\alpha - \beta) \frac{P}{(1+P)}) - \phi \\
 -\frac{2u_1 c}{(1+P)^3} + \frac{2\lambda_1 Z\beta}{(1+P)^3} & +\lambda_1 Z(\alpha - \beta) \frac{P}{(1+P)} & -Z(\alpha - \beta) \frac{P}{(1+P)} \\
 & -\lambda_2 P(\beta - \alpha - \omega) & -P(\beta - \alpha - \omega)' \\
 & -\frac{\lambda_1}{(1+P)^2} (\beta + Z\beta) & \frac{\delta(u_1 c)}{\delta \lambda_1} \frac{1}{(1+P)^2} \\
 & -\lambda_2 (\beta - \alpha - \omega)' & -\frac{Z\beta}{(1+P)^2} \\
 & & -(\beta - \alpha - \omega)
 \end{array} \right]$$



where

$$\frac{\delta c}{\delta P} = (\lambda_1 + u_{11}c/(1 + P)^2) / (u_{11}/(1 + P)) \quad (256)$$

$$\frac{\delta(u_1c)}{\delta p} = \lambda_1(1 + P)^2/u_{11}c + 2\lambda_1c \quad (257)$$

$$\frac{\delta c}{\delta \lambda_1} = (1 + P)^2/u_{11} \quad (258)$$

$$\frac{\delta(u_1c)}{\delta \lambda_1} = c(1 + P) + u_1(1 + P)^2/u_{11} \quad (259)$$

$$\frac{\delta(u_1c)}{\delta Z} = \frac{\delta c}{\delta Z} = \frac{\delta c}{\delta \lambda_2} = 0 \quad (260)$$

Specialising this to the values around the steady state with  $P^* = 0$  (using the steady state equations) gives

$$\left[ \begin{array}{cccc} (\beta - \alpha - \omega) & 0 & 0 & 0 \\ Z\beta - (\lambda_1 + u_{11}c)/u_{11} & 0 & -1/u_{11} & 0 \\ -\lambda_1(\beta + Z\beta') & -\lambda_1[f'' - 2\alpha' - Z\alpha''] & 0 & 0 \\ -\lambda_2(\beta' - \alpha' - \omega') & & & \\ u_1/u_{11} + 2\lambda_1 Z\beta & -\lambda_1(\beta + Z\beta') & c + u_1/u_{11} - Z\beta & -(\beta - \alpha - \omega) \\ & -\lambda_2(\beta' - \alpha' - \omega') & & \end{array} \right] \quad (261)$$



Around the steady state with  $P^* \neq 0$  the Jacobian matrix becomes



$$\left[ \begin{array}{cccc}
0 & P(\beta' - \alpha' - \omega') & 0 & 0 \\
-\lambda_1(1 + P)/u_{11} & -\frac{\lambda_1}{\lambda_2}(\beta' - \alpha' - \omega') & -(1 + P)^2/u_{11} & 0 \\
-\frac{\lambda_1}{(1+P)^2}(\beta + Z\beta') & -\lambda_1[f'' - 2(\alpha' - \beta' \frac{P}{(1+P)})] \\
& +\lambda_1 Z(\alpha'' - \beta'' \frac{P}{(1+P)}) & \frac{\lambda_1}{\lambda_2}(\beta' - \alpha' - \omega') & -P(\beta' - \alpha' - \omega') \\
-\lambda_2(\beta' - \alpha' - \omega') & -\lambda_2(\beta'' - \alpha'' - \omega'') & & \\
\lambda_1 u_1/u_{11}(1 + P) & -\frac{\lambda_1}{(1+P)^2}(\beta + Z\beta') & u_1/u_{11} & 0 \\
+2\lambda_1 Z\beta/(1 + P)^3 & -\lambda_2(\beta' - \alpha' - \omega') & & 
\end{array} \right]$$

(262)



#### A.4 Sufficiency of the Necessary Conditions for Optimality with Exogenous Growth in Prevalence

Let  $z^*(t)$ ,  $\lambda_1^*(t)$ ,  $c^*(t)$  satisfy

$$u_1 = \lambda_1^*(1 + p_0 e^{\gamma t}) \quad (263)$$

$$\dot{z}(t) = f(z^*) - \phi z^* - z^* \left( \alpha - \frac{\beta p_0 e^{\gamma t}}{1 + p_0 e^{\gamma t}} \right) - c^* \quad (264)$$

$$\dot{\lambda}_1 = -\lambda_1^* \left[ \alpha - \beta p_0 e^{\gamma t} (1 + p_0 e^{\gamma t}) + f' - \phi \right] \quad (265)$$

and let  $z(t)$ ,  $c(t)$  be any feasible path which satisfies (264). Then

$$\begin{aligned} & \int \left[ u \left( \frac{c}{(1 + p_0 e^{\gamma t})} \right) - u \left( \frac{c^*}{(1 + p_0 e^{\gamma t})} \right) \right] dt \\ & \leq \int \left[ u_1^* \left( \frac{c}{(1 + p_0 e^{\gamma t})} \right) - u_1^* \left( \frac{c^*}{(1 + p_0 e^{\gamma t})} \right) \right] dt = \end{aligned} \quad (266)$$

$$\int \lambda_1^* \left[ \begin{array}{l} \left( f(z) - \phi z - z \left( \alpha - \frac{\beta p_0 e^{\gamma t}}{1 + p_0 e^{\gamma t}} \right) - \dot{z} \right) \\ - \left( f(z^*) - \phi z^* - z^* \left( \alpha - \frac{\beta p_0 e^{\gamma t}}{1 + p_0 e^{\gamma t}} \right) - \dot{z}^* \right) \end{array} \right] dt \quad (267)$$

$$\leq \int \lambda_1^* \left[ \left( f'^* - \phi - \left( \alpha - \frac{\beta p_0 e^{\gamma t}}{1 + p_0 e^{\gamma t}} \right) \right) (z - z^*) - (\dot{z} - \dot{z}^*) \right] dt \quad (268)$$

$$= \int \left[ -\dot{\lambda}_1^* (z - z^*) - \lambda_1^* (\dot{z} - \dot{z}^*) \right] dt \quad (269)$$

$$= -\lim_{t \rightarrow \infty} \lambda_1^*(t) z(t) \leq 0$$



## A.5 The Jacobian for the Centrally Planned Public Health Investment Model with Recovery

Linearising the dynamic equations (211)-(210)-(216)-(215) for

$$\frac{\delta c}{\delta p} = \lambda_1(1+p)/u_{11} + c/(1+p) \quad (270)$$

$$\frac{\delta(u_1c)}{\delta p} = \lambda_1(1+p)^2/u_{11} + 2\lambda_1c \quad (271)$$

$$\frac{\delta c}{\delta \lambda_1} = (1+p)^2/u_{11} \quad (272)$$

$$\frac{\delta(u_1c)}{\delta \lambda_1} = c(1+p) + u_1(1+p)^2/u_{11}$$

$$\frac{\delta(u_1c)}{\delta z} = \frac{\delta c}{\delta z} = \frac{\delta c}{\delta \lambda_2} = 0 \quad (273)$$

the Jacobian is







Specialising this to the values around the steady state with  $p^* = \frac{(\beta - \alpha - \omega - \rho)}{\rho}$   
gives







which can be reparametrised as

$$\begin{bmatrix} a & b & 0 & 0 \\ c & d & e & 0 \\ f & g & -d & -b \\ h & f & -c & -a \end{bmatrix} \quad (276)$$



## References

- [1] Acevedo-Garcia, D. (2000). "Residential Segregation and the Epidemiology of Infectious Diseases", *Social Science and Medicine*, 51, 1143-1161.
- [2] Addington, W. W. (1979). "Patient Compliance: the Most Serious Remaining Problem in the Control of Tuberculosis in the United States", *Chest*, 76 (Suppl.), 741-743.
- [3] Adler, N. E. et al. (1993). "Socio-Economic Inequalities in Health - No Easy Solution", *AMA-Journal of American Medical Association*, 269, 24, 3140-3145.
- [4] Aghion, P. and Howitt, P. (1992). "A Model of Growth through Creative Destruction", *Econometrica*, 60, 2, 323-351.
- [5] Alvi, A. R. et al., (1998). "Prevalence of Pulmonary Tuberculosis on the Roof of the World", *International Journal of Tuberculosis and Lung Diseases*, 2, 11, 909-913.
- [6] Anderson, R. M. (1979). "The influence of Parasite Infection on the Dynamics of Host Population Growth", in R. M. Anderson, B. D. Turner, L. R. Taylor (Eds.), *Population Dynamics*, Blackwell, Oxford.
- [7] Anderson, R. M. (1982). *The population Dynamics of Infectious Diseases: Theory and Applications*, Chapman & Hall, London.
- [8] Anderson, R. M. (1998). "Analytical Theory of Epidemics" in R. M. Krause, *Emerging infections. Biomedical Research Reports*, Academic Press, San Diego.
- [9] Anderson, R. M. and May, R. M. (1979). "Population Biology of Infectious Diseases: Part 1", *Nature*, 280, 361-367.
- [10] Anderson, R. M. and May, R. M. (Eds.) (1982). *Population Biology and Infectious Diseases*, Springer-Verlag, Berlin.



- [11] Anderson, R. M. and May, R. M. (1984). "Spatial, Temporal and Genetic Heterogeneity in Host Populations and the Design of Immunization Programmes", *IMA Journal of Mathematical Applications in Medical Biology*, 1, 233-266.
- [12] Anderson, R. M. and May, R. M. (1991). *Infectious Diseases of Humans. Dynamics and Control*, Oxford University Press, Oxford.
- [13] Anderson, R. M. et al. (1986). "A Preliminary Study of the Transmission Dynamics of the Human Immunodeficiency Virus (HIV), the Causative Agent of AIDS", *IMA Journal of Mathematical Applications in Medical Biology*, 3, 229-263.
- [14] Annas, G. J. (1993). "Control of Tuberculosis - The Law and the Public's Health", *New England Journal of Medicine*, 328, 587-588.
- [15] Arrow, K. J. (1962). "The Economic Implications of Learning by Doing", *Review of Economic Studies*, 29.
- [16] Audibert, M. and Etard, J. F. (1986). "Impact of Schistosomiasis on Rice Output and Farm Inputs in Mali", *Journal of African Economy*, 7, 2, 185-207.
- [17] Bailey, N. T. J. (1975). *The Mathematical Theory of Infectious Diseases and Its Applications*, Charles Griffin and Company LTD, London.
- [18] Bardsley, M. et al. (1998). *The Health of Londoners: a Public Health Report for London*, Health of Londoners Project, London.
- [19] Barnhoorn, F. and Adriaanse, H. (1992). "In Search of Factors Responsible for Noncompliance among Tuberculosis Patients in Wardha District, India", *Social Science and Medicine*, 34, 3, 291-306.
- [20] Barro, R. J. (1974). "Are Government Bonds Net Wealth?", *Journal of Political Economy*, 82, 1095-1118.



- [21] Barro, R. J. and Becker, G. S. (1989). "Fertility Choice in a Model of Economic Growth", *Econometrica*, 57:, 2, 481-501.
- [22] Barro, R. J. and Lee, J. W. (1994). "Losers and Winners in Economic Growth", *World Bank Economic Review*, 267-297 Suppl. S 1993.
- [23] Barro, R. J. and Sala-i-Martin, X. (1995). *Economic Growth*, McGraw-Hill, Inc, New York.
- [24] Barron, H. L. (1993). "New York City's Tuberculosis Control Efforts: The Historical Limitations of the 'War on Consumption'", *American Journal of Public Health* , 83, 758.
- [25] Barry, M. A. et al. (1986). "Tuberculosis Screening in Boston's Homeless Shelters", *Public Health Report*, 101, 5, 487-494.
- [26] Bartel, A. and Taubman, P. (1979). "Health and Labour Market Success: The Role of Various Diseases", *Review of Economics and Statistics*, 61, 1-8.
- [27] Baumol, W. J. (1952). *Economic Dynamics*, G. Bell and Sons L.T. D., London.
- [28] Bates, B. (1992). *Bargaining for Life: A Social History of Tuberculosis, 1876-1938*, Philadelphia, University of Pennsylvania Press.
- [29] Bates, J. H. et al. (1976). "Phase Type of Tubercle Bacilli Isolated from Patients with Two or More Sites of Organ Involvement", *American Review of Respiratory Disease*, 114, 353-358.
- [30] Bayer, R. (1996). "Does Anything Work? Public Health and the Nihilist Thesis", paper presented at the *124th Annual Meeting of the American Public Health Association*, New York City.
- [31] Bayer, R. and Dupuis, L. (1995). "Tuberculosis, Public Health, and Civil Liberties", *American Review of Public Health*, 16, 307-326.



- [32] Bayer, R. and Wilkinson, D. (1995). "Directly Observed Therapy for Tuberculosis: History of an Idea", *Lancet*, 345, 1545-1548.
- [33] Becker, G. S. (1960). "An Economic Analysis of Fertility", in *Demographic and Economic Change in Developed Countries*, A conference of the Universities - NBER Committee for Economic Research, Princeton University Press, Princeton, NJ.
- [34] Becker, G. S. and Barro, R. J. (1988). "A Reformulation of the Economic Theory of Fertility", *Quarterly Journal of Economics*, 103, 1-25.
- [35] Becker, G. S. and Lewis, H. G. (1973). "On the Interaction between the Quantity and Quality", *Journal of Political Economy*, 81, S279-S288.
- [36] Becker, G. S. et al. (1990). "Human Capital, Fertility, and Economic Growth", *Journal of Political Economy*, 98, 5, S12-S37 Part 2.
- [37] Behrman, J. R. (1990). *The Action of Human Resources and Poverty on one another: What we Have yet to Learn?*, LSMS Working Paper, 74, Washington, DC, World Bank.
- [38] Behrman, J. R. (1993). "The Economic Rationale for Investing in Nutrition in Developing Countries", *World Development*, 21.
- [39] Behrman, J. R. (1996). *Impact of Health and Nutrition on Education*, World Bank Research Observer, 11.
- [40] Behrman, J. R. and Deolalikar, A. B. (1987). "Will Developing Country Nutrition Improve with Income? A Case Study for Rural South India", *Journal of Political Economy*, 95.
- [41] Behrman, J. R. and Deolalikar, A. B. (1988). "Health and Nutrition", in H. B. Chenery and T. N. Srinivasan, *Handbook of Development Economics*, Vol. 1, North Holland, Amsterdam.



- [42] Behrman, J. R. and Deolalikar, A. B. (1989). "Wages and Labour Supply in Rural India: the Role of Health, Nutrition and Seasonality", in D. E. Sahn, *Causes and Implications of Seasonal Variability in Household Food Security*, The Johns Hopkins University Press, Baltimore, MD.
- [43] Belling, E. Y. et al. (1993). "Association of Tuberculosis Infection with Increased Time in or Admission to the New-York-City Jail", *Journal of the American Medical Association*, 269, 17, 2228-2231.
- [44] Benveniste, D. and Scheinkman, J. A. (1982). "Duality-Theory for Dynamic Optimization Models of Economics - The Continuous Time Case", *Journal of Economic Theory*, 27, 1,1-19.
- [45] Bhatti, N. et al. (1995). "Increasing Incidence of Tuberculosis in England and Wales: a Study of the Likely Causes", *British Medical Association*, 275, 487-489.
- [46] Black, J. (1988). "Financing Health Care", *British Medical Journal*, 296, 6627, 1000-1010.
- [47] Blanchard, O. J. and Fischer, S. (Eds.) (1989). *Lectures on Macroeconomics*, Cambridge, Mass. M. I. T., Princeton.
- [48] Blaug, M. (1963). "A Survey of the Theory of Process Innovations", *Economica*, New Series, 30.
- [49] Bloch, A. B. et al. (1996). "The Need for Epidemic Intelligence", *TB Surveillance - Public Health Reports*, 3. 6-31.
- [50] Blower, S. M. et al. (1990). "Loglinear Models, Sexual Behaviour and HIV: Epidemiological Implications of Heterosexual Transmission", *Journal of Acquired Immuno Deficiency Syndrome*, 3, 763-772.
- [51] Blower, S. M. et al. (1995). "The Intrinsic Transmission Dynamics of TB Epidemics", *Nature Medicine*, 1, 8, 815-821.



- [52] Blower, S. M. and McLean, A. R. (1994). "Prophylactic Vaccines, Risk Behavior Change and the Probability of Eradicating HIV in San Francisco", *Science*, 265, 1451-1454.
- [53] Brinkerhoff, D. and Goldsmith, A. (1992). "Promoting the Sustainability of Development Institution: a Framework of Strategy", *World Development*, 20, 369-383.
- [54] Brogger, S. (1967). "System Analysis in Tuberculosis Control: a Model", *American Review of Respiratory Disease*, 95, 419-434.
- [55] Brudney, K. and Dobkin, J. (1991). "Resurgent Tuberculosis in New York City: Human Immunodeficiency Virus Homelessness, and the Decline of Tuberculosis Control Programs", *American Review of Respiratory Diseases*, 144, 745-749.
- [56] Bryder, L. (1988). *Below the Magic Mountain: A Social History of Tuberculosis in Twentieth-Century Britain*, Clarendon Press, Oxford, England.
- [57] Burkhardt, K. R. and Nel, E. E. (1980). "Monitoring Regularity of Drug Intake in Tuberculous Patients by Means of Simple Urine Tests", *South Africa Medical Journal*, 57, 981-985.
- [58] Burmeister, E. and Dobell, A. R. (1970). *Mathematical Theories of Economic Growth*, The MacMillan Company, New York.
- [59] Cain, L. P. (1981). "Urban Growth and City-Systems in the United States, 1840-1860", *Business History Review*, 55, 3, 433-435.
- [60] Cain, L. P. (1983). "Incomes in the 20th Century United States - Discussion", *Journal of Economic History*, 43, 1, 241-242.
- [61] Caldwell, J. C. (1976). "Towards a Restatement of Demographic Transition Theory", *Population and Development Review*, 69, 318-328.



- [62] Caldwell, J. C. (1982). "Dynamics of Population and Family Welfare, 1981", *Population Development Review*, 8, 3, 620-621.
- [63] Canetti, G. (1972). "Endogenous Reactivation and Exogenous Reinfection. Their Relative Importance with Regard to the Development of Non-Primary Tuberculosis", *Bulletin of the International Union Against Tuberculosis*, 47, 116-122.
- [64] Cantwell, M. F. et al. (1994). "Epidemiology of Tuberculosis in the United States, 1985 through 1992", *Journal of the American Medical Association*, 272, 535-539.
- [65] Carter, G. F. and Williams, B. R. (1957). *Industry and Technical Progress*, Oxford University Press, London.
- [66] Carter, G. F. and Williams, B. R. (1958). *Investment in Innovation*, Oxford University Press, London.
- [67] Carter, G. F. and Williams, B. R. (1959). *Science in Industry*, Oxford University Press, London.
- [68] Carstairs, V. and Morris, R. (1989). "Deprivation and Mortality - an Alternative to Social Class", *Community Medicine*, 11, 3, 210-219.
- [69] Cass, D. (1965). "Optimum Economic Growth in an Aggregative Model of Capital Accumulation", *Review of Economic Studies*, 32, 233-240.
- [70] Castillo-Chavez, C. (1978). "Review of Recent Models of HIV/AIDS Transmission" in S. A., Levin et al. *Applied Mathematical Ecology*, Springer-Verlag, Berlin.
- [71] Cella, D. et al. (1991). "Socioeconomic Status and Cancer Survival", *Journal of Clinical Oncology*, 9, 1500-1509.
- [72] Centers for Disease Control (Public Health Service, U.S. Department of Health and Human Services) (1989), "A Strategic Plan for the Elim-



ination of Tuberculosis in the United States", *Morbidity and Mortality Weekly Report (Recommendations and Report)*, 38 (S-3).

- [73] Centers for Disease Control (Public Health Service, U.S. Department of Health and Human Services) (1990). "Guidelines for Preventing the Transmission of Tuberculosis in Health Care Settings, with Special Focus on HIV-Related Issues", *Morbidity and Mortality Weekly Report (Recommendations and Report)* (RR-17), 39, 1-29.
- [74] Centers for Disease Control (Public Health Service, U.S. Department of Health and Human Services) (1991), "Nosocomial Transmission of Multidrug-Resistant Tuberculosis among HIV-Infected Persons: Florida and New York, 1988-1991", *Morbidity and Mortality Weekly Report (Recommendations and Report)*, 144, 745-749.
- [75] Centers for Disease Control (Public Health Service, U.S. Department of Health and Human Services) (1992). "National Action Plan to Combat Multidrug-Resistant Tuberculosis", *Morbidity and Mortality Weekly Report (Recommendations and Report)*, 41, 1-48
- [76] Centers for Disease Control (Public Health Service, U.S. Department of Health and Human Services) (1993). "Management of Persons Exposed to Multidrug-Resistant Tuberculosis", *Morbidity and Mortality Weekly Report (Recommendations and Report)* 41, 61-71.
- [77] Chan-Yeung, M. et al. (1971). "Reactivation of Inactive Tuberculosis in Northern Canada", *American Review of Respiratory Diseases*, 104, 861-865.
- [78] Chapman, K. S. and Hariharan, G. (1994). "Controlling for Causality in the Link from Income to Mortality", *Journal of Risk and Uncertainty*, 8, 85-93.
- [79] Chaulet, P. (1987). "Compliance with Anti-Tuberculosis Chemotherapy in Developing Countries", *Tubercle*, suppl., 68, 19.



- [80] Chaulet, P. (1990). "Compliance with Chemotherapy for Tuberculosis: Responsibilities of the Health Ministry and of Physicians", *Bulletin of International Union Against Tuberculosis*, 66, (Suppl. 33-35).
- [81] Chaulk, P. et al. (1995). "Eleven Years of Community-Based Directly Observed Therapy for Tuberculosis.", *Journal of the American Medical Association*, 274, 945-951.
- [82] Chiang, A. C. (1992). *Elements of Dynamic Optimization*, McGraw-Hill International Editions, Economics Series, New York.
- [83] Cigno, A. (1998). "Fertility Decisions when Infant Survival is Endogenous", *Journal of Population Economics*, 11, 21-28.
- [84] Comstock, G. W. (1982a). "Epidemiology of Tuberculosis", *American Review of Respiratory Diseases*, 125, 8-15.
- [85] Comstock, G. W. (1982b). *Tuberculosis*, in A. S. Evans and H. A. Feldman (Eds.), *Bacterial Infections in Man*, Plenum Medical Books, New York and London.
- [86] Cronje', G. (1984). "Tuberculosis and Mortality Decline in England and Wales, 1851-1910", in R. Woods and J. Woodward (Eds.). *Urban Disease and Mortality in Nineteenth Century in England*, Batsford Academic and Educational and St. Martin's Press, London and New York.
- [87] Curtin, P. (1989). *Death by Migration: Europe's Encounter with the Tropical World in the Nineteenth Century*, Cambridge University Press, Cambridge, England.
- [88] Dankowicz, H. (1997). *Chaotic Dynamics in Hamiltonian Systems: with Applications to the Celestial Mechanics*, World Scientific, Singapore.



- [89] Dasgupta, P. (1969). "On the Concept of Optimal Population", *Review of Economic Studies*, 36, 3, 295-318.
- [90] Dasgupta, P. (1974). "Some Alternative Criteria for Justice between Generations", *Journal of Public Economics*, 3, 405-424.
- [91] Dasgupta, P. (1997). "Nutritional Status, the Capacity of Work, and Poverty Trap", *Journal of Econometrics*, 77, 1, 5-37.
- [92] Deaton, A. (1992). *Understanding Consumption*, Oxford University Press, Oxford.
- [93] De Cock, K. M. and Chaisson, R. E. (1999). "Will DOTS Do it? A Reappraisal of Tuberculosis Control in Countries with High Rates of HIV Infection", *International Journal of Tuberculosis and Lung Diseases*, 3, 6, 457-465.
- [94] De Jong, M. C. M. et al. (1995). "How Does Transmission of Infection Depend on Population Size?" in D. Mollison, *Epidemic Models*, Cambridge, Cambridge University Press.
- [95] De Palma, A. and Lefevre, C. (1988). "Population Systems with (Non)-Extensive Interaction Rate", *Math. Comput. Modelling*, 10, 359-365.
- [96] Diekmann, O. et al. (1995). "The Legacy of Kenmark and Mckendrick" in D. Mollison, *Epidemic Models*, Cambridge, Cambridge University Press.
- [97] Dievler, A. (1997). "Fighting Tuberculosis in the 1990s: How Effective is Planning in Policy Making?", *Journal of Public Health Policy*, 18, 2, 167-187.
- [98] Dievler, A. and Pappas, G. (1999). "Implications of Social Class and Race for Urban Public Health Policy Making: a Case Study of HIV/AIDS and TB Policy in Washington, DC", *Social Science and Medicine*, 48, 8, 1095-1102.



- [99] Dorfman, R. (1991). "Theorists of Economic-Growth from David Hume to the Present - with a Perspective on the Next Century - Rostow, W. W.", *Journal of Economic Literature*, 29, 2, 573-591.
- [100] Drucker, E. et al. (1994). "Childhood Tuberculosis in the Bronx, New York", *Lancet*, 343, 1482-1485.
- [101] Dubos, R. and Dubos, J. (1987). *The White Plague: Tuberculosis, Man and Society*, Rutgers University Press, New Brunswick, NJ.
- [102] Duleep, H. O. (1996). "Measuring the Effect of Income on Adult Mortality Using Longitudinal Administrative Record Data", *Journal of Human Resources*, XXI, 1, 238-251.
- [103] Easterlin, R. A. (1980). *Population and Economic Change in Developing Countries*, Chicago University Press, Chicago.
- [104] Edelstein-Keshet, L. (1988). *Mathematical Models in Biology*. The Random House, Birkhauser Mathematics Series - New York.
- [105] Ehrlich, I. and Lui, F. (1991). "Intergenerational Trade, Longevity and Economic Growth", *Journal of Political Economy*, 99, 5, 1029-1059.
- [106] Ehrlich, I. and Lui, F. (1997). "The Problem of Population and Growth: A Review of the Literature: A Review of the Literature from Malthus to Contemporary Models of Endogenous Population and Endogenous Growth", *Journal of Economic Dynamic and Control*, 21, 205-242.
- [107] Elender, F. et al. (1998). "Tuberculosis Mortality in England and Wales During 1982-1992; Its Association with Poverty, Ethnicity and AIDS" *Social Science and Medicine*, 46, 673-681.
- [108] Entwisle, B. and Winegarden, C. R. (1984). "Fertility and Pension Programs in Less Developed Countries, a Model of Mutual Reinforcement", *Economic Development and Cultural Change*, 32, 2, 331-354.



- [109] Ettner, S. L. (1996). "New Evidence on the Relationship between Income and Health", *Journal of Health Economics*, 15, 1, 67-85.
- [110] Ewald, P. W. (1994). *Evolution of Infectious Disease*, Oxford University Press, Oxford.
- [111] Fairchild, A. L. and Oppenheimer, G. M. (1998). "Public Health Nihilism versus Pragmatism: History, Politics, and the Control of Tuberculosis", *American Journal of Public Health*, 88, 7, 1105-1117.
- [112] Farmer, P. (1996). "Social Inequalities and Emerging Infectious Diseases", *Emerging Infectious Diseases*, 2, 259-269.
- [113] Farmer, P. (1997). "Social Scientists and the New Tuberculosis", *Social Science Medicine*, 44,3, 347-358.
- [114] Farmer, P. et al. (1991). "Tuberculosis, Poverty and Compliance: Lessons from Rural Haiti", *Social Science and Medicine*, 49, 393-404.
- [115] Fatkenheuer, G. et al. (1999). "The Return of Tuberculosis", *Diagnostic Microbiology and Infectious Diseases*, 34, 2, 139-146.
- [116] Feinstein, C. (1990). "Britain's Overseas Investment in 1913", *Economic History Review*, 18, 2, 288-295.
- [117] Feinstein, J. S. (1993). "The Relationship between Socioeconomic Status and Health - a Review of the Literature", *The Milbank Quarterly*, 71, (2), 279-322.
- [118] Feldberg, G. D. (1995). *Disease and Class: Tuberculosis and the Shaping of Modern North American Society*, Rutgers University Press, New Brunswick, New Jersey.
- [119] Feldman, M. P. (1989). "Theory of Population and Economic Growth", *International Journal of Forecasting*, 5, 1, 142-143.



- [120] Feng-Zeng, Z. et al. (1996). "Results of Directly Observed Short-Course Chemotherapy in 112,842 Chinese Patients with Smear Positive Tuberculosis", *Lancet*, 347, 358-362.
- [121] Ferebee, S. H. (1970). "Controlled Chemoprophylaxis Studies in Tuberculosis: a General Review", *Advances in Tuberculosis Research*, 17, 28-106, Karger, Basel.
- [122] Finerberg, H. and Wilson, M. (1996). "Social Vulnerability and Death by Infection", *New England Journal of Medicine*, 334, 859-860.
- [123] Ford, L. R. (1955). *Differential Equations*, 2nd ed., McGraw-Hill Company Inc, New York.
- [124] Forsyth, A. R. (1959). *Theory of Differential Equations*, Dover Publications, Inc., New York.
- [125] Fourie, P. B. and Weyer, K. (1996). "Epidemiology of Tuberculosis in South-Africa and estimated impact of HIV" in *Tuberculosis Control in South-Africa: Joint Programme Review*, 208, WHO, Geneva.
- [126] Fox, W. (1962). "Self-Administration of Medicaments: a Review of Published Work and a Study of the Problems", *Bulletin of International Union Against Tuberculosis*, 32, 307-331.
- [127] Freudenberg, N. (1995). "A New Role for Community Organizations in the Prevention and Control of Tuberculosis", *Journal of Community Health*, 20, 15-28.
- [128] Frieden, T. R. (1994). "Tuberculosis Control and Social Change", *American Journal of Public Health*, 84, 1721-1723.
- [129] Frieden, T. R. et al. (1993). "The Emergence of Drug-Resistant Tuberculosis in New York City", *New England Journal of Medicine*, 328, 8, 527-532.



- [130] Frieden, T. R. et al. (1995). "Tuberculosis in New York City: Turning the Tide", *New England Journal of Medicine*, 333, 229-233.
- [131] Gangadharam, P. R. J. (1994). "Chemotherapy of Tuberculosis under Program Conditions" (editorial), *Tubercle Lung Disease*, 75, 241-244.
- [132] Geoffard, P. Y. and Philipson, T. (1996). "Rational Epidemics and their Public Control", *International Economic Review*, 37, 3, 603-624.
- [133] Gibson, K. F. et al. (1995). "Respiratory Diseases Disproportionately Affecting Minorities", *Chest*, 108, 5, 1380-1392.
- [134] Ginsberg, A. M. (1998). "The Tuberculosis Epidemic: Scientific Challenges and Opportunities", *Public Health Reports*, 113, 128-136.
- [135] Gittler, J. (1994). "Controlling Resurgent Tuberculosis: Public Health Agencies, Public Policy, and Law", *Journal of Health, Politics and Law*, 19, 1, 107-147.
- [136] Globe, M. et al. (1993). "Treatment of 171 Patients with Pulmonary Tuberculosis Resistant to Isoniazid and Rifampin", *New England Journal of Medicine*, 328, 527-532.
- [137] Ginsberg, A. M. (1998). "The Tuberculosis. Scientific Challenges and Opportunities", *Public Health Report*, 113, 128-136.
- [138] Grimshaw, R. (1990). *Nonlinear Ordinary Differential Equations*, Blackwell Scientific Publication, Oxford.
- [139] Grout, P. A. (1982). "Welfare Economics of Decision Making with Changing Preferences", *Review of Economic Studies*, 49, 83-90.
- [140] Grossman, G. M. and Helpman, E. (1991). "Quality Ladders in the Theory of Growth", *Review of Economic Studies*, 58, 1, 43-61.
- [141] Grzybowski, S. et al. (1965). "Reactivations in Inactive Pulmonary Tuberculosis", *American review of Respiratory Diseases*, 93, 352-261.



- [142] Guha, S. (1993). "Nutrition, Sanitation, Hygiene and the Likelihood of Death: The British Army in India", *Population Studies*, 47, 385-401.
- [143] Haan, M. et al. (1987). "Poverty and Health- Prospective Evidence from the Alameda County Study", *American Journal of Epidemiology*, 125, 6, 989-998.
- [144] Hadley, G. (1961), *Linear Algebra*, Addison-Wesley Publishing Company, Inc., Reading, MA, US.
- [145] Hadley, J. and Osei, A. (1982). "Does Income Affect Mortality? - An Analysis of the Effects of Different Types of Income on Age. Sex Race-Specific Mortality-Rates in the United-States", *Medical Care*, 20, 9, 901-914.
- [146] Hagan, L. (1977). "New Jersey Afro-Americans: from colonial times to the present", in B. Cunningham and W. H. Wise, *The New Jersey Ethnic Experience*, Union City, New Jersey.
- [147] Haggerty, M. and Johnson, C. (1996). "The Social Construction of the Distribution of Income and Health", *Journal of Economic Issues*, 30, 2, 525-532.
- [148] Hahn, F. H. and Matthews, R. C. O. (1964). "The Theory of Economic Growth: a Survey", *The Economic Journal*, 296, 74, 779-902.
- [149] Hamer, W. H. (1906). Epidemic Disease in England, *The Lancet*, i, 733-739.
- [150] Hammond, P. J. and Rodriguez-Clare, A. (1993). "On Endogenising Long-Run Growth", *Scandinavian Journal of Economics*, 95, 391-425.
- [151] Hardy, A. (1993). *The Epidemic Streets: Infectious Disease and the Rise of Preventive Medicine, 1856-1900*, Clarendon Press, Oxford, England.
- [152] Harrod, R. F. (1948). *Towards a Dynamic Economics*, Macmillan, London.



- [153] Hayward, A. (1998). *Tuberculosis Control in London - The Need for Change: a Report for the Thames Regional Directors of Public Health*, NHS Executive, London.
- [154] Hayward, A. C. and Coker, R. J. (2000). "Could a Tuberculosis Epidemic Occur in London as it Did in New York?", *Emerging Infectious Diseases*, 6, 1, 12-16.
- [155] Hethcote, H. W. (1976). "Qualitative Analyses of Communicable Disease Models", *Mathematical Biosciences*, 28, 335-56.
- [156] Hethcote, H. W. (1978). "An Immunization Model for a Heterogeneous Population", *Theor. Prop. Biol.*, 14, 338-349.
- [157] Hethcote, H. W. (1980). "Integral Equation Models for Endemic Infectious Diseases", *Journal of Mathematical Biology*, 9, 37-47.
- [158] Hethcote, H. W. (1983). "Measles and Rubella in the United States", *American Journal of Epidemiology*, 117, 2-13.
- [159] Hethcote, H. W. (1989). "Three Basic Epidemiological Models" in S. A., Levin et al. *Applied Mathematical Ecology*, Springer-Verlag, Berlin.
- [160] Hethcote, H. W. and Levin, S. A. (1988). "Periodicity in Epidemiological Models", in S. A., Levin et al. (Eds.), *Applied Mathematical Ecology*, Biomathematics, Springer, Berlin.
- [161] Hethcote, H. W. et al. (1981a). "Periodicity and Stability in Epidemic Models: a Survey", in S. N. Busenberg, K. L. Cooke, (Eds), *Differential Equations and Applications in Ecology, Epidemics and Population Problems*, Academic Press, New York.
- [162] Hethcote, H. W. et al. (1981b). "Stability Analysis for Models of Diseases without Immunity", *Journal of Mathematical Biology*, 13, 185-198.



- [163] Hethcote, H. W. and Van Ark, J. W. (1987). "Epidemiological Models for Heterogeneous Populations: Proportionate Mixing, Parameters Estimation and Immunization Programs", *Mathematical Biosciences*, 84, 85-118.
- [164] Hicks, J. P. (1932). *The Theory of Wages*, Macmillan, London.
- [165] Hitchcock, S. E. (1986). "Extinction Probabilities in Predator-Prey Models", *Journal of Applied Probabilities*, 23, 1-13.
- [166] Holm, J. (1969). *Development from Tuberculosis Infection to Tuberculosis Disease: TSRU Progress Report*, KNCV, The Hague, The Netherlands.
- [167] Hopewell, P. C. et al. (1988). *Strategies for Treating Tuberculosis: Costs and Outcomes*, Center for Disease Control and Prevention.
- [168] Hubbard, J. H. and West, B. H. (1995). *Differential Equations: A Dynamical Systems Approach*, Springer, Berlin.
- [169] Hurtig, A. K. et al. (1999). "Tuberculosis Control and Directly Observed Therapy from the Public Health/Human Rights Perspective", *International Journal of Tuberculosis and Lung Diseases*, 3, 7, 553-560.
- [170] Inada, K. (1963). "On the Two-Sector Model of Economic Growth: Comments and a Generalisation", *Review of Economic Studies*, 30.
- [171] Institute of Medicine (1992). *Emerging Infections: Microbial Threats and Health in the United States*, National Academy Press, Washington, DC.
- [172] International Union Against Tuberculosis and Lung Disease, (1996). *Tuberculosis Guide*, Geneva, Switzerland.
- [173] Iseman, M. D. (1993). "Treatment of Multidrug-Resistant Tuberculosis", *New England Journal of Medicine*, 329, 784-791.



- [174] Iseman, M. D. and Sbarbaro, J. A. (1992). "The Increasing Prevalence of Resistance to Antituberculosis Chemotherapeutic Agents: Implications for Global Tuberculosis Control", *Current Clinical Topics on Infectious Diseases*, 12, 188-207.
- [175] Iseman, M. D. et al. (1993). "Directly Observed Treatment of Tuberculosis: We Can't Afford Not to Try It", *New England Journal of Medicine*, 328, 576-578.
- [176] Jain, N. K. (1992). "Drug Resistance in India: a Tragedy in the Making", *Indian Journal of Tuberculosis*, 39, 145-148.
- [177] Jaramillo, E. (1999). "Encompassing Treatment with Prevention: the Path for a Lasting Control of Tuberculosis", *Social Science and Medicine*, 49, 393-404.
- [178] Jensen, E. R. (1990). "An Econometric Analysis of the Old-Age Security Motive for Childbearing", *International Economic Review*, 31, 4, 953-968.
- [179] Johnston, W. D. (1993). "Tuberculosis" in K. F. Kiple, *The Cambridge World History of Human Disease*, Cambridge University Press, New York.
- [180] Juvekar, S. K. et al. (1995). "Social and Operational Determinants of Patient Behaviour in Lung Tuberculosis", *Indian Journal of Tuberculosis*, 42, 87-94.
- [181] Kalemli-Ozcan, S. et al., (2000). "Mortality Decline, Human Capital Investment, and Economic Growth", *Journal of Development Economics*, 62, 1-23.
- [182] Kendall, W. S. and Saunders, I. W. (1983). "Epidemics in Competition II: the General Epidemic", *Journal Review of Statistical Society B*, 45, 2, 238-244.



- [183] Kennedy, E. et al. (1992). "Health and Nutrition Effects of Cash Crop Production in Developing-Countries - A Comparative-Analysis", *Social Science and Medicine*, 35, 5, 689-97
- [184] Kermarck, W. O. and McKendrick, A. G. (1927). "A Contribution to the Mathematical Theory of Epidemics", *Proceeding Royal Society of London*, Series A, 115: 700-721.
- [185] Kitagawa, E. M. et Hauser, P. M. (1973). *Differential Mortality in the United States: A Study in Socioeconomic Epidemiology*, Harvard University Press, Cambridge, Mass.
- [186] Kochi, A. (1991). "The Global Tuberculosis Situation and the New Control Strategy of the World Health Organization", *Tubercle*, 72, 1-6.
- [187] Kochi, A. (1994). "Tuberculosis, Distribution, Risk-Factors, Mortality", *Immunobiology*, 191, 4-5, 325-336.
- [188] Koopmans, T. C. (1965). "On the Concept of Optimal Growth", *Pontificia Academia Scientiarum*, 225-288, Vatican City.
- [189] Koopman, J. S. and Lynch, J. W. (1999). "Individual Causal Models and Population System Models in Epidemiology", *American Journal of Public Health*, 89, 1170-1174.
- [190] Kopanoff, D. E. et al. (1988). "Recurrent Tuberculosis: Why do Patients Develop Disease Again?", *American Journal of Public Health*, 78, 30-33.
- [191] Krishnaji, N. (1983). "Poverty and Fertility", *Economic and Political Weekly*, 18, 19, 2, 865.
- [192] Kunst, A. E., et al. (1990). "Socioeconomic Mortality Differences in the Netherlands in 1950-1984 - A Regional Study of Cause-Specific Mortality", *Social Science and Medicine*, 31, 2, 141-152.



- [193] LaFond, A. K. (1995). "Improving the Quality of Investment in Health: Lessons on Sustainability", *Health Policy and Planning*, 10 Suppl., 63-76.
- [194] Lahelma, E. and Valkonen, T. (1990). "Health and Social Inequities in Finland and Elsewhere", *Social Science and Medicine*, 31, 3, 257-265.
- [195] Landesman, S. (1992). "Commentary: Tuberculosis in New York City - The Consequences and Lessons of Failure", *American Journal of Public Health*, 83, 76-768.
- [196] La Salle J. and Lefschetz, S. (1961). *Stability by Liapunov's Direct Method*, Academic Press, London.
- [197] Lederberg, R. E. et al. (Eds.) (1992). *Emerging Infections: Microbial Threats to Health in the United States*, National Academy Press, Washington, DC.
- [198] Lee, R. D. (1982). "Economics of Populations", *Population Development Review*, 8, 4, 851-852.
- [199] Lee, R. D. (1987). "Population Dynamics of Humans and Other Animals", *Demography*, 24, 4, 443-465.
- [200] Lee, R. D. (1997). "Population Dynamics: Equilibrium, Disequilibrium, and Consequences of Fluctuations" in M. R. Rosenzweig, O. Stark, (Eds), *Handbook of Population and Family Economics*, Amsterdam, Elsevier.
- [201] Lee, D. K. C. and Gan, C. L. (1989). "An Economic Analysis of Fertility, Market Participation and Marriage Behaviour in Recent Japan", *Applied Economics*, 21, 59-68.
- [202] Lee, P. and Paxman, D. (1997). "Re-inventing Public Health", *Annual Review of Public Health*, 18, 1-35.



- [203] Leibenstein, H. (1969). *Economic Backwardness and Economic Growth*, Wiley, New York, NY.
- [204] Leonard, D. (1981). "The Signs of the Costate Variables and Sufficiency Conditions in a Class of Optimal Control Problems", *Economic Letters*, 8, 321-325.
- [205] Leonard, D. and Van Long, N. (1992). *Optimal Control Theory and Static Optimization in Economics*, Cambridge University Press, Cambridge.
- [206] Lerner, B. H. (1993). "New York City's Tuberculosis Control Efforts: the Historical Limitations of the 'War on Consumption'", *American Journal of Public Health*, 83, 758-766.
- [207] Lincoln, D. W. (1993). "Reproductive Health, Population Growth, Economic Development and Environmental Change" in *CIBA Foundation Symposia*, 197-214.
- [208] Listorti, J. A. (1999). "Is Environmental Health Really a Part of Economic Development or Only an Afterthought?", *Environment and Urbanization*, 11, 1, 89-100.
- [209] Lotka, A. J. (1923). "Contribution of the Analysis of Malaria Epidemiology", *American Journal of Hygiene*, 3, suppl. 1, 1-21.
- [210] Lucas, D. (1988) "Recent Fertility Trends in the Pacific Islands", *Journal of Polynesian Society*, 97, 1, 93-94.
- [211] Luft, H. S. (1975). The Impact of Poor Health on Earnings", *Review of Economics and Statistics*, 57, 43-57.
- [212] Lutter, R. and Morrall, J. F. (1994). "Health-Health Analysis - A New Way to Evaluate Health and Safety Regulation", *Journal of Risk and Uncertainty*, 8, 43-66.



- [213] McBride, D. (1991). *From TB to AIDS: Epidemics among Urban Blacks since 1900*, State University of New York, Albany.
- [214] McFarlane, N. (1989). "Hospitals, Housing, and Tuberculosis in Glasgow", *Social History of Medicine*, 2, 59-85.
- [215] McGinnis, L. (1980). *Department of Health and Human Services: Promoting Health/Preventing Disease: Objectives for the Nation*, US Government Printing Office, Washington, DC.
- [216] McKee, M. and Jacobson, B. (2000). "Public Health in Europe", *Lancet*, 356, 665-670.
- [217] McKenna, M. T. et al. (1998). "The Fall after the Rise: Tuberculosis in the United States, 1991 through 1994", *American Journal of Public Health*, 88, 1059-1063.
- [218] McKeown, T. and Record, R. G. (1962). "Reasons for the Decline of Mortality in England and Wales During the Nineteenth Century", *Population Studies*, 94, 122.
- [219] McNeill, W. H. (1992). *The Global Condition: Conquerors, Catastrophes and Community*, Princeton University Press, Princeton, NJ.
- [220] Mackenback, J. P. and Looman, C. W. N. (1993). "Living Standards and Mortality in European Community", *Journal of Epidemiology and Community Health*, 48, 140-145.
- [221] Mahmoudi, A. and Iseman, M. D. (1993). "Pitfalls in the Care of Patients with Tuberculosis: Common Errors and Their Association with the Acquisition of Drug Resistance.", *Journal of the American Medical Association*, 270, 65-68.
- [222] Malthus, T. R. (1798). *An Essay on the Principal of Population*, Penguin Books (1970).



- [223] Mangasarian, O. L. (1966). "Sufficiency Conditions for the Optimal Control of Nonlinear Systems", *Journal of SIAM Control*, 4, 139-152.
- [224] Marx, K. (1867). "Das Kapital: Volume I", English Edition (1974), Lawrence and Wishart, London.
- [225] Mas-Colell, A. and Whinston, M. D. (1995). *Microeconomic Theory*, Oxford University Press, Oxford.
- [226] Mata, J. I. (1985). "Integrating the Client's Perspective in Planning a Tuberculosis Education and Treatment Program in Honduras", *Medical Anthropology*, 9, 1, 57.
- [227] May, R. M. (1975). "Biological Population Obeying Difference Equations: Stable Points, Stable Cycles and Chaos.", *Journal of Theoretical Biology*, 51, 511-524.
- [228] May, R. M. (1985). "Regulation of Populations with Non-Overlapping Generations by Microparasites: a Purely Chaotic System", *American Natur.*, 125, 573-584.
- [229] May, R. M. and Anderson, R. M. (1985). "Endemic Infections in Growing Populations", *Mathematical Biosciences*, 77, 141-156.
- [230] May, R. M. and Anderson, R. M. (1989). "The Transmission Dynamics of Human Immunodeficiency Virus." in S. A. Levin et al., (Eds.), *Applied Mathematical Ecology*, Springer-Verlag, Berlin.
- [231] May, R. M. and Anderson, R. M. (1990). "Parasite-Host Coevolution", *Parasitology*, 100, S89-S101.
- [232] May, R. M. et al. (1988). "Possible Demographic Consequences of HIV/AIDS Epidemics", *Mathematical Biosciences*, 90, 475-505.
- [233] Meade, J. E. (1955). *Trade and Welfare*, Oxford University Press, Oxford.



- [234] Meade, J. E. (1961). *A Neo-Classical Theory of Economic Growth*, Allen and Unwin, London.
- [235] Medio, A. and Gallo, G. (1992). *Chaotic Dynamics. Theory and Applications to Economics*, Cambridge University Press, Cambridge.
- [236] Meltzer, D. (1992). *Mortality Decline, the Demographic Transition and Economic Growth*, PhD Dissertation, University of Chicago, Chicago, IL.
- [237] Menzies, R. et al. (1993). "Factors Associated with Compliance in Treatment of Tuberculosis", *Tubercle and Lung Disease*, 74, 32.
- [238] Mercer, A. (1990). *Disease, Mortality and Population in Transition, Epidemiological-Demographic Change in England since the Eighteenth Century as part of a Global Phenomenon*, Leicester University Press, Leicester, UK.
- [239] Michel, P. (1982). "On the Transversality Condition in Infinite Horizon Optimal Problems", *Econometrica*, 50, 4, 975-985.
- [240] Mill, J. S. (1848). *The Principles of Political Economy: with Some of their Applications to Social Philosophy*
- [241] Moore, M. et al. (1997). "Trends in Drug-Resistant Tuberculosis in the United States, 1993-1996", *Journal of the American Medical Association*, 278, 833-837.
- [242] Morris, M. (1993). "Epidemiology and Social Networks: Modeling Structured Diffusion", *Sociological Methods and Research*, 22, 1, 99-126.
- [243] Morse, D. I. (1996). "Directly Observed Therapy for Tuberculosis: Spend Now or Pay Later", *British Medical Journal*, 312, 719-720.
- [244] Mutatkar, R. K. (1995). "Public Health Problems of Urbanization". *Social Science Medicine*, 41, 7, 977-981.



- [245] Nakielna, E. M. et al. (1975). "Lifelong Follow-up of Inactive Tuberculosis: its Value and Limitations", *American Review of Respiratory Disease*, 112, 765-772.
- [246] Nardell, E. A. (1993). "Beyond Four Drugs: Public Health Policy and the Treatment of the Individual Patient with Tuberculosis", *American Review of Respiratory Diseases*, 148, 2-5.
- [247] Nardell, E. A. et al. (1986). "Exogenous Reinfection with Tuberculosis in a Shelter for the Homeless", *The New England Journal of Medicine*, 315, 1570-1575.
- [248] National MDR-TB Task Force, (1992). *National Action Plan to Combat Multidrug Resistant Tuberculosis*, Atlanta, GA: Center for Disease Control.
- [249] Neher, P. A. (1971). "Peasants, Procreation and Pensions", *American Economic Review*, 61, 380-389.
- [250] Nelson, R. R. (1959). "The Economics of Invention: a Survey of the Literature", *Journal of Business*, 32.
- [251] Nerlove, M. and Raut, L. K. (1997). "Growth Models with Endogenous Population: A General Framework" in M. R. Rosenzweig, O. Stark, (Eds), *Handbook of Population and Family Economics*, Amsterdam, Elsevier.
- [252] Nerlove, M. et al. (1985). "The Old-Age Security Hypothesis", *Journal of Development Economics*, 18, 2-3, 243-252.
- [253] Netto, E. M. et al. (1999). "Progress in Global Tuberculosis Control 1995-1996 with Emphasis on 22 High-Incidence Countries", *International Journal of Tuberculosis and Lung Diseases*, 3, 4, 310-320.
- [254] Neville, K. et al. (1994). "The Third Epidemic - Multidrug-Resistant Tuberculosis", *Chest*, 105, 45-48.



- [255] Nightingale, E. O. et al. (1990). "Apartheid Medicine. Health and Human Rights in South Africa", *Journal of the American Medical Association*, 264, 16, 2097.
- [256] Nisbet, R. M. and Gurney, W. S. C. (1982). *Modelling Fluctuating Populations*, Wiley, Chichester, UK.
- [257] Nuyangulu, D. S. et al. (1990). "Factors Contributing to a Successful Tuberculosis Control Program in Malawi", *Bulletin of International Union Against Tuberculosis*, 66 (Suppl. 45-46).
- [258] Orcutt Duleep, H. (1985). "Measuring the Effect of Income on Adult Mortality Using Longitudinal Administrative Record Data", *The Journal of Human Resources*, 32, 238-251.
- [259] Ormerod, P. and Skinner, C. (1980). "Reinfection Tuberculosis: Two Cases in a Family of a Patient with Drug-Resistant Disease", *Thorax*, 35, 56-59.
- [260] Pablos-Mendez, A. et al. (1998). "Global Surveillance for Anti-Tuberculosis Drug Resistance, 1994-1997", *New England Journal of Medicine*, 338, 1641-1648.
- [261] Packard, R. M. (1989). *White Plague, Black Labor: Tuberculosis and the Political Economy of Health and Disease in South Africa*, University of California Press, Berkley.
- [262] Palmer, B. L. (1989). "Implications of the Changing Male Mortality", in *Changes in the Stochastic Planning Horizon and Its Effects Upon the Elderly*, Doctoral dissertation, M.I.T.
- [263] Perko, L. (1991). *Differential Equations and Dynamical Systems*, Springer-Verlag, New York.
- [264] Phelps, E. S. (1962). "The New View of Investment: a Neoclassical Analysis", *Quarterly Journal of Economics*, 76, 548-567.



- [265] Phillips, D. R. (1993). "Urbanization and Human Health", *Parasitology*, 106, S93-S107.
- [266] Philipson, T. (1995). "Public Health and Economic Epidemiology", in M. Tommasi and K. N. Ierulli, *The New Economics of Human Behaviour*, Cambridge University Press, Cambridge, UK.
- [267] Pigou, A. C. (1932). *The Economics of Welfare* (4th ed.), Macmillan, London.
- [268] Pitchenik, A. E. (1990). "Tuberculosis Control and the AIDS Epidemic in Developing Countries", *Annales of International Medicine*, 113, 89-91.
- [269] Plant, A. J. and Rushworth, R. L. (1997). "Health Outcomes and Infectious Disease Control", *Health Policy*, 39, 1, 17-27.
- [270] Porco, T. C. and Blower, S. M. (1998). "Quantifying the Intrinsic Transmission Dynamics of Tuberculosis", *Theoretical Population Biology*, 54, 2, 117-132.
- [271] Porter, J. D. H., McAdam, K. P. W. J. (1994). "The Reemergence of Tuberculosis", *Annual Review of Public Health*, 15, 303-323.
- [272] Porter, J. D. H. and Ogden, J. A. (1997). "Ethics of Directly Observed Therapy for the Control of Infectious Diseases", *Bulletin Institute Pasteur*, 95, 117-127.
- [273] Porter, J. D. H. and Ogden, J. A. (1998). "Social Inequalities in the Re-emergence of Infectious Disease." in S. S. Strickland and P. S. Shetty, (Eds.), *Human Biology and Social Inequality*, Cambridge University Press, Cambridge, England.
- [274] Prskawetz, A. and Feichtinger, G. (1995). "Endogenous Population Growth May Imply Chaos", *Journal of Population Economics*, 8, 1, 59-80.



- [275] Radcliffe, J. and Rass, L. (1986). "The Asymptotic Speed of Propagation of the Deterministic Non-Reducible n-Type Epidemic", *Journal of Mathematical Biology*, 23, 341-359.
- [276] Raleigh, J. W. and Wichelhanen, R. (1973). "Exogenous Reinfection with Mycobacterium Tuberculosis Confirmed by Phage Typing", *Americal Review of Respiratory Disease*, 108, 639-642.
- [277] Raleigh, J. W. et al. (1975). "Evidence for Infection by Two Distinct Strains of Mycobacterium Tuberculosis in Pulmonary Tuberculosis", *Americal Review of Respiratory Disease*, 112, 497-503.
- [278] Ramsey, F. P. (1928). "A Mathematical Theory of Savings", *Economic Journal*, 38, 543-559.
- [279] Ranis, G. et al. (2000). "Economic Growth and Human Development", *World Development*, 28, 2, 197-219.
- [280] Raut, L. K. and Srinivasan, T. N. (1992). *Theories of Economic Growth Old and New*, Discussion Paper, 92-37, Department of Economics, University of California, San Diego, CA.
- [281] Raut, L. K. and Srinivasan, T. N. (1994). "The Dynamics of Endogenous Growth", *Economic Theory*, 4, 777-790.
- [282] Ravaglione, M. C. and Luelmo, F. (1996). "Update on the Global Epidemiology of Tuberculosis", *Current Issues in Public Health*, 2, 192-197.
- [283] Ravaglione, M. C. et al. (1997). "Assessment of Worldwide Tuberculosis Control", *Lancet*, 350, 624-629.
- [284] Rawls, J. (1972). *A Theory of Justice*, Oxford University Press, Oxford.
- [285] Razin, A. and Sadka, E. (1995). *Population Economics*, M.I.T. Press, Cambridge, CA.



- [286] Rebelo, S. (1991). "Long-Run Policy Analysis and Long-Run Growth", *Journal of Political Economy*, 99, 3, 500-521.
- [287] Reichman, L. B. (1991). "The U-Shaped Curve of Concern", *American Review of Respiratory Diseases*, 1144, 741-742.
- [288] Ricardo, D. (1817). *Principles of Political Economy and Taxation*.
- [289] Rich, A. R. (1951). *The Pathogenesis of Tuberculosis*, Springfield, Charles C. Thomas, Illinois, US.
- [290] Rieder, H. L. (1989). "Tuberculosis among American-Indians of the Contiguous United-States", *Tuberculosis Surveillance - Public Health Report*, 104, 6, 653-657.
- [291] Robinsons, J. A. and Srinivasan, T. N. (1997). "Long-Term Consequences of Population Growth", in M. R. Rosenzweig, O. Stark, (Eds.), *Handbook of Population and Family Economics*, Amsterdam, Elsevier.
- [292] Rodrigues, L. C. and Smith, P. G. (1990). "Tuberculosis in Developing Countries and Methods for its Control", *Trans Royal Society for Tropical Medicine and Hygiene*, 84, 739-744.
- [293] Romer, D. (1996). *Advance Macroeconomics*, The McGraw-Hill, Inc. New York.
- [294] Romer, P. M. (1986). "Increasing Returns and Long-Run Growth", *Journal of Political Economy*, 94, 1002-1037.
- [295] Romer, P. M. (1989). "Capital Accumulation in the Theory of Long-Run Growth", in R. Barro (Ed.) *Modern Mactoeconomics*, Harvard University Press, Cambridge, Mass.
- [296] Romer, P. M. (1990). "Endogenous Technical Change", *Journal of Political Economy*, 98, 5, S71-S102 Part 2.



- [297] Romeyn, J. A. (1970). Exogenous Reinfection in Tuberculosis, *Americal Review of Respiratory Disease*, 101, 923-927.
- [298] Roscoe, C. Y. et al. (1996). "Strategies for Suppression, Containment and Eradication of Resurgent Tuberculosis", *Journal of Health Care for the Poor and Underserved*, 8, 4, 424-436.
- [299] Ross, R. (1908). *Report on the Prevention of Malaria in Mauritius*. Waterlow and Sons, London.
- [300] Ross, R. (1911). *The Prevention of Malaria*, John Murray Ltd., London.
- [301] Rostow, W. W. (1990). *Theorists of Economic-Growth from David Hume to the Present*, Oxford University Press.
- [302] Rubel, A. J. and Garro, L. C. (1992). "Social and Cultural Factors in the Successful Control of Tuberculosis", *TB Surveillance - Public Health Report*, 107, 626-636.
- [303] Ruffino-Netto, A. (1995). "Avaliacao Do Excesso De Casos De Tuberculose Atribuitos A Infecao HIV/AIDS: Ensaio Preliminar.", *Revista Saude Publica*, 29, 4, 279-282.
- [304] Sah, R. K. (1991). "The Effects of Child-Mortality Changes on Fertility Choice and Parental Werlfare", *Journal of Political Economy*, 99, 3, 582-606.
- [305] Santiago, A. M. (1991). "The Spatial Dimensions of Ethnic and Racial Stratification", *PSC Research Reports*, University of Michigan, Population Studies Center, Ann Arbor, MI, 91-230.
- [306] Schultz, T. P. (1980). "An Economic Interpretation of the Decline in Fertility in a Rapidly Developing Country: Consequences of Development and Family", in R. A. Easterling, *Population and Economic*



*Change in Developing Countries*, The University of Chicago Press, Chicago.

- [307] Schultz, T. P. (1981). *Economics of Population*, Addison-Wesley, Reading, MA.
- [308] Schultz, T. P. and Tausel, A. (1993). *Measurement of Returns to Adult Health*, LSMS 95, World Bank, Washington, DC.
- [309] Scolari, C. et al. (1999). "Incidence of Tuberculosis in a Community of Senegalese Immigrants in Northern Italy", *International Journal of Tuberculosis and Lung Disease*, 3, 1, 18-22.
- [310] Seierstad, A. (1998). "Fields of Extremals and Infinite Horizon Optimal Control Problems", *Optimal Control Appl. Met.*, 19, 6, 377-392.
- [311] Sepkowitz, K. A. (1996). "How Contagious is Tuberculosis?", *Clinical Infectious Diseases*, 23, 5, 954-962.
- [312] Serfling, R. E. (1952). "Historical Review of Epidemic Theory", *Human Biology*, 24, 3, 143-166.
- [313] Sheshinki, E. (1967). "Optimal Accumulation with Learning by Doing" in K. Shell (Ed.), *Essays on the Theory of Optimal Economic Growth*, Cambridge, MA, M.I.T. Press.
- [314] Silver, M. (1972). "An Econometric Analysis of Spatial Variations in Mortality Rates by Age and Sex", in V. Fuchs, *Essays in the Economics of Health and Medical Care*, Columbia University Press, New York, NY.
- [315] Smith, A. (1776). *An Inquiry into the Nature and Causes of the Wealth of the Nations*, University of Chicago Press, Chicago, IL.
- [316] Snider, D. E. (1990). "General View of Problems with Compliance in Programmes for the Treatment of Tuberculosis", *Bulletin of International Union against Tuberculosis*, 57, 55-260.



- [317] Solow, R. M. (1956). "A Contribution to the Theory of Economic Growth", *Quarterly Journal of Economics*, 70, 65-94.
- [318] Solow, R. M. (1960). "Investment and Technical Progress", in K. J. Arrow et al., *Mathematical Methods in the Social Sciences*, Stanford University Press, Stanford.
- [319] Solow, R. M. (1962). "Technical Progress, Capital Formation and Economic Growth", *American Economic Review Papers and Proceedings*, 7.
- [320] Solow, R. M. (1974). "The Economics of Resources or the Resources of Economics", *American Economic Review*, 64, 2, 1-14.
- [321] Sommer, A. (1995). "W(h)ither Public Health?", *Public Health Reports*, 110, 657-661.
- [322] Sorlie, P. D. et al. (1995). "US Mortality by Economic, Demographic, and Social Characteristics - The National Longitudinal Mortality Study", *American Journal of Public Health*, 85, 7, 949-956.
- [323] Spence, D. P. et al. (1993). "Tuberculosis and Poverty", *British Medical Journal*, 307, 759-761.
- [324] Stephens, C. (1995). "The Urban-Environment, Poverty and Health in Developing Countries", *Health Policy Plan*, 10, 2, 109-121.
- [325] Stern, N. (1991). "The Determinants of Growth", *The Economic Journal*, 101, 122-133.
- [326] Stiglitz, J. E. (1974). "Incentives and Risk Sharing in Sharecropping", *Review of Economic Studies*, 41, 219-255.
- [327] Styblo, K. (1985). "The Relationship Between the Risk of Tuberculosis Infection and the Risk of Developing Infectious Tuberculosis", *Bulletin of International Union Against Tuberculosis*, 60, 3-4, 117-119.



- [328] Sudre, P. et al. (1992). "Tuberculosis: a Global Overview of the Situation Today", *Bulletin of the World Health Organization*, 70, 149-159.
- [329] Sumartojo, E. (1993). "When Tuberculosis Treatment Fails", *American Review of Respiratory Diseases*, 147, 1311-1320.
- [330] Sundstrom, W. C. and David, P. A. (1988). "Old-Age Security Motives, Labor Market and Farm Family Fertility in Antebellum America", *Explorations in Economic History*, 25, 2, 164-197.
- [331] Sutherland, I. et al. (1982). "The Development of Clinical Tuberculosis Following Infection with Tubercle Bacilli", *Tubercle*, 62, 255-268.
- [332] Susser, M. (1994). "The Logic in Ecological: I. The Logic of Analysis", *American Journal of Public Health*, 84, 825-829.
- [333] Swan, T. W. (1956). "Economic Growth and Capital Accumulation", *Economic Record*, 32, 343-361.
- [334] Szreter, S. (1988). "The Importance of Social Intervention in Britain's Mortality Decline, 1850-1914: A Re-Interpretation of the Role of Public Health", *The Society for the Social History of Medicine*, 1, 7-10.
- [335] Ten Dam, H. and Pio, G. A. (1982). "Pathogenesis of Tuberculosis and Effectiveness of BCG Vaccination", *Tubercle*, 63, 225-233.
- [336] Tomes, N. (1989). "The White Plague Revisited", *Bullettin of the History of Medicine*, 63, 467-468.
- [337] Tulskey, J. P. et al. (1998). "Screening for Tuberculosis in Jail and Clinic Follow-Up after Release", *American Journal of Public Health*, 88, 2, 223-226.
- [338] Twumasi, P. A. (1996). "Non Compliance with Tuberculosis Treatment: the Kumasi Experience", *Tropical Doctor*, 26, 43-44.



- [339] United Nations (UN) (1996a). *World Urbanization Prospects: The 1996 Revision*.
- [340] UN (1996b). *United Nations Urban Agglomeration Chart*.
- [341] UN (1997). *The Urban Challenge*.
- [342] UN (1998). *State of the World Population: The New Generations*.
- [343] UN University/World Institute for Development Research (UNU/WIDER) (1998a). *Health Status and Health Policies in Sub-Saharan Africa: A Long-Term Perspective*, Working Paper n.141.
- [344] UNU/WIDER (1998b). *The Urban Challenge in Africa. Growth and Management of Its Large Cities*.
- [345] Velasco, H. J. X. (1996). "Effects of Treatment and Prevalence Dependent Recruitment on the Dynamics of a Fatal Disease", *Journal of Mathematics Applied in Medicine and Biology*, 13, 3, 175-192.
- [346] Verhulst, F. (1996). *Non-Linear Differential Equations and Dynamical Analysis*, Springer, Berlin.
- [347] Villarino, M. E. et al. (1992). "The Multidrug-Resistant Efforts to Control Tuberculosis", *Public Health Report*, 107, 6, 616-625.
- [348] Viscusi, R. (1994). "Mortality Effects of Regulatory Costs and Policy Evaluation Criteria", *RAND Journal of Economics*, 25 (1), 94-109.
- [349] Volterra, V. (1926). "Variazioni e Fluttuazioni del Numero d'Individui in Specie Animali Conviventi", *Mem. Acad. Lincei*, 2, 31-113.
- [350] Vynnycky, E. and Fine, P. E. M. (1997). "The Natural History of Tuberculosis: the Implications of Age-Dependent Risks of Disease and the Role of Reinfection", *Epidemiological Infections*, 119, 183-201.
- [351] Waaler, H. T. (1968). A Dynamic Model for the Epidemiology of Tuberculosis, *American Review of Respiratory Disease*, 98, 591-600.



- [352] Waldman, R. J. "Income Distribution and Infant Mortality", *Quarterly Journal of Economics*, 32, 1283-1303.
- [353] Wallace, D. (1990). "Roots of Increased Health Inequality in New York", *Social Science and Medicine*, 31, 1219-1227.
- [354] Wallace, R. and Wallace, D. (1993). "Inner-City Disease and the Public Health of the Suburbs: the Sociogeographic Dispersion of Point-Source Infection" *Environment and Planning A*, 25, 1707-1723.
- [355] Wallace, R. and Wallace, D. (1995). "US Apartheid and the Spread of AIDS to the Suburbs: a Multi-City Analysis of the Political Economy of Spatial Epidemic Threshold", *Social Science and Medicine*, 41, 333-345.
- [356] Wallace, R. and Wallace, D. (1997). "The Destruction of US Minority Urban Communities and the Resurgence of Tuberculosis: Ecosystem Dynamics of the White Plague in the Dedeveloping World" *Environment and Planning A*, 29, 269-291.
- [357] Wallace, R. et al. (1994). "Will AIDS Be Contained Within US Minority Urban Populations?" *Social Science Medicine*, 39, 8, 1051-1062.
- [358] Wallace, R. et al. (1995). "The Spatio-Temporal Dynamics of AIDS and TB in New York Metropolitan Region from a Sociogeographic Perspective: Understanding the Linkages of Central City and Suburbs", *Environment and Planning A*, 27, 1085-1108.
- [359] Wallace, R. et al. (1997). "AIDS, Tuberculosis, Violent Crime, and Low Birthweight in Eight US Metropolitan Areas: Public policy, Stochastic Resonance, and the Regional Diffusion of Inner-City Markers", *Environment and Planning A*, 29, 525-555.
- [360] Walker, A. P. et al. (1989). "Per Capita Income in Breast Cancer Patients", *Journal of National Medical Association*, 81, 1065-1068.



- [361] Walt, G. (1993). "WHO under Stress - Implications for Health Policy", *Health Policy*, 24, 2, 125-144.
- [362] Walters, A. A. (1963). "Production and Cost Functions", *Econometrica*, 30.
- [363] Ware, J. E. et al. (1986). "Comparison of Health Outcomes at a Health Maintenance Organization with Those of Fee-for-Service Care", *Lancet*, 1, 8488, 1017-1022.
- [364] Watts, S. J. (1997). *Epidemics and History: Disease, Power and Imperialism*, New Haven, Yale University Press.
- [365] Weatherall, D. J. et al. (1996). *Oxford Textbook of Medicine*, 3rd ed., Oxford University Press, Oxford.
- [366] Weis, S. E. et al. (1994). "The Effect of Directly Observed Therapy on the Rates of Drug Resistance and Relapse in Tuberculosis", *New England Journal of Medicine*, 330, 17, 1179-1184.
- [367] Werhane, M. J. et al. (1989). "The Tuberculosis Clinic", *Chest*, 96, 815-818.
- [368] Whitehead, M. E. (1986). "Housing Economics - An Applied Approach", *Environmental Planning*, C 4, 3, 380-381.
- [369] Willis, R. J. (1980). "The Old Age Security Hypothesis and Population Growth", in T. Burch (Ed.), *Demographic Behaviour: Interdisciplinary Perspectives on Decision Making*, Westview Press, Boulder, CO.
- [370] Willis, R. J. (1986). "Externalities and Population", in *The Economic Consequences of Population Growth in Economic Development: Contributed Papers*, National Academy Press, Washington, DC.
- [371] Willis, R. J. (1989). *Public and Private Intergenerational Transfers, Economic Growth and Demographic Transition*, Academia Sinica, Taipei, Taiwan.



- [372] Wilson, L. G. (1990). "The Historical Decline of Tuberculosis in America: Its Causes and Significance", *Journal of the History of Medicine and Allied Sciences*, 45, 366-396.
- [373] Wilson, M. E. (1995). "Infectious Diseases: an Ecological Perspective", *British Medical Journal*, 311, 1681-1684.
- [374] World Bank (2000), *World Development Indicators*, <http://www.worldbank.org/data>
- [375] World Health Organization (1998a). *Health for All in the 21st Century*, Geneva, Switzerland.
- [376] World Health Organization (1998b). *Tuberculosis and HIV. A Clinical Manual*, <http://www.who.int>
- [377] World Health Organization (2000a). *Global TB Report*, Geneva, Switzerland.
- [378] World Health Organization (2000b). *Global Tuberculosis Control. WHO Report 2000*, Geneva, Switzerland, <http://www.who.int/gtb/publications/globrep00/index.html>
- [379] World Health Organization (2000c). Fact Sheet N. 104. <http://www.who.int/inf-fs/en/fact104.html>
- [380] World Health Organization (2000d). *World Health Report 2000*, Geneva, Switzerland.
- [381] World Health Organization/GTP (1997). *The Epidemiology of Tuberculosis Control: An Analysis Using Mathematical Models*, TRAC Geneva, Switzerland.
- [382] World Health Organization/International Union Against Tuberculosis and Lung Disease (1997). *Anti-Tuberculosis Drug Resistance in the World*, Geneva, Switzerland.



- [383] Yaari, M. E. (1981). "Rawls, Edgeworth, Shapley, Nash - Theories of Distributive Justice Reexamined", *Journal of Economic Theory*, 24, 1, 1-39.
- [384] Young, R. C. et al. (1997). "Strategies for Suppression, Containment and Eradication of Resurgent Tuberculosis", *Journal of Health Care for the Poor and Underserved*, 8, 3, 424-436.
- [385] Zumla, A. (1998). "Establishing a United Front against the Injustice of Tuberculosis", *International Journal of Tuberculosis and Lung Diseases*, 2 (3), 179-181.