

**THE EVOLUTION OF THE  
ENGLISH BUILDING REGULATIONS  
1840 – 1914**

**Volume I**

THE EVOLUTION OF THE ENGLISH BUILDING  
REGULATIONS 1840 - 1914

---

Roger Henley Harper  
M.A., Dip.Arch., (Cantab.) A.R.I.B.A.

---

The first of two volumes

A Thesis for the Degree of Doctor of Philosophy  
presented to  
The Faculty of Architectural Studies  
The University of Sheffield

June 1978

## CONTENTS

### Volume 1

	page
List of Tables	2
List of Abbreviations	4
Acknowledgements and Declaration	5
Summary	6
Introduction	7
Definitions	10
Plan of Thesis	14
Prelude	15
I Sanitary Reform and the Regulation of Buildings 1840 - 1844	19
II The Metropolitan Building Act 1840 - 1855	67
III Provincial sources, Town Improvement and Public Health pre 1840 - 1858	124
IV The Metropolitan Building Act 1855 - 1875	162
V Early Provincial Building By-laws 1858 - 1875	223

### Volume II

VI Model and Provincial Building By-laws 1875 - 1890	266
VII London : the pressure for change 1875 - 1891	342
VIII The London Building Act : 1894	389
IX Model and Provincial Building By-laws 1890 - 1914	441
X London : Fire, Steel and Reinforced Concrete 1895 - 1914	508
Conclusion	558
Bibliography	592

**TABLES**

**ABBREVIATIONS**

**ACKNOWLEDGEMENTS**

**SUMMARY**

LIST OF TABLES

Following		Page	
CHAPTER I	T1	Bill for Improving the Dwellings of the Working Classes 1840.	57
	T2	Bill for the Better Drainage and Improvement of Buildings in Large Towns and Cities. January 1841.	58
	T3	Bill for Regulating Buildings in Large Towns. May 1841.	60
CHAPTER II	T4	Metropolitan Building Act 1844.	111
CHAPTER III	T5	Towns Improvement Clauses Act 1847.	159
CHAPTER IV	T6	Act for the Better Management of the Metropolis 1855.	212
		Metropolitan Building Act 1855.	214
CHAPTER V	T7	Form of By-laws as to New Streets and Buildings 1858.	261
CHAPTER VI	T8	Model By-laws as to New Streets and Buildings 1877.	320
	T9	Amendments to the above, made 1877-1883.	334
	T10	Amendments to the above, made 1883-1889.	337
CHAPTER VII	T11	Metropolis Management and Building Act Amendment Act 1878. By-laws made in 1879 under Section 16 of the above act.	382
	T12	Metropolitan Management and Building Act Amendment Act 1882. By-laws made in 1886 under Section 16 of the Metropolis Management and Building Act Amendment Act 1878.	384
	T13	By-laws made in 1891 under Section 31 of the L.C.C. (General Powers) Act 1890. By-laws made in 1891 under Section 16 of the Metropolis Management and Building Act Amendment Act 1878. Regulations made under the Public Health (London) Act 1891.	386
CHAPTER VIII	T14	London Building Act 1894.	417
	T15	Housing Regulations of the L.C.C 1889-1900.	439
CHAPTER IX	T16	Model By-laws made 1890-1905.	491
	T17	Rural Model By-laws 1901.	495
	T18	Amendments made to Model By-laws in 1904.	497
	T19	Intermediate Model By-laws 1905.	500
	T20	Model By-laws made under the Public Health (Amendment) Act 1907.	502
	T21	Model By-laws. Urban Series IV, 1912.	503

CHAPTER X	T22	London Building Act 1894 (Amendment) Act 1898.	548
	T23	By-laws made in 1900 under Section 202 of the Metropolis Management Act 1855.	549
	T24	London Building Acts (Amendment) Act 1905.	550
	T25	L.C.C (General Powers) Act 1909 - steel skeleton frame regulations.	553
	T26	L.C.C (General Powers) Act 1909 - reinforced concrete regulations 1915.	556

## LIST OF ABBREVIATIONS

T	=	Table (followed by its number)
S	=	Sheet (followed by its number)
C	=	Clause (followed by its number)
Sc	=	Schedule (followed by its number)
P.P	=	Parliamentary Paper
H	*	Hansard
T	=	The Times
B	=	The Builder
M.B.A.	=	Metropolitan Building Act
L.B.A.	=	London Building Act
L.C.C.	=	London County Council
U.D.C.	=	Urban District Council
R.D.C.	=	Rural District Council
D.S.	=	District Surveyor
R.I.B.A.	=	Royal Institute of British Architects
A.A.	=	Architectural Association
d.p.c.	=	damp proof course
w.c.	=	water closet
e.c.	=	earth closet
s.v.p.	=	soil vent pipe
r.w.p.	=	rainwater pipe
Q.B.D.	=	Queen's Bench Division
J.P.	=	Justice of the Peace (Journal)
L.T.	=	Law Times
L.J.	=	Law Journal
C.B.	=	Common Bench

## ACKNOWLEDGEMENTS

John Nelson Tarn B.Arch., Ph.D., F.R.I.B.A.  
Roscoe Professor of Architecture  
University of Liverpool

for his valuable advice and criticism at all stages of this work.

The Town Clerks, Archivists, Surveyors and Librarians of  
Liverpool, Manchester, Bristol, Birmingham, Leeds, Newcastle upon  
Tyne, Blackburn, Birkenhead and Sheffield  
and in particular

Frank D Entwisle F.R.I.C.S., C.Eng., F.I.Struct.E., P.P.I.A.A.S.  
Former Building Surveyor, Department of Planning and Design  
Sheffield City Council Metropolitan District

for their assistance in locating and obtaining local acts, by-laws  
and records.

The staff of:

The Royal Institute of British Architects,  
The British Architectural Library,  
Department of the Environment Library,  
Public Record Office and  
Sheffield University Library

for providing access to original sources of information.

Financial assistance in the form of a  
Royal Institute of British Architects Research Award, 1975

The Department of Architecture, University of Sheffield for providing  
secretarial facilities and  
Miss Lynne Jarvis for kindly typing this Thesis.

---

## DECLARATION

Certain parts of this Thesis have been used as the basis for two  
published articles, namely:

"Concrete's Battle for London 1867 - 1886" CONCRETE Journal of  
the Concrete Society, Vol 10 No 10 October 1976 p28-30, 42

"The Conflict between English building regulations and architectural  
design 1890 - 1918" JOURNAL OF ARCHITECTURAL RESEARCH (R.I.B.A.  
and A.I.A.) Vol 6 No 1 March 1977 p.24-33

---



THE EVOLUTION OF THE ENGLISH BUILDING REGULATIONS : 1840 - 1914

Thesis for the Degree of Doctor of Philosophy

Faculty of Architectural Studies : University of Sheffield

Roger H. Harper 1978

SUMMARY

This Thesis sets out to analyse the growth of the building regulations in this country during their most formative years in the nineteenth and early twentieth centuries. The originality of the study is that it is the first complete history of the regulations.

The study concentrates upon the regulations which relate primarily to building design and construction. Particular emphasis is placed on the national trend, as exemplified by the Model Building By-laws in conjunction with the influential role played by the London Building Acts. Reference is also made, by way of illumination, to the content and implementation of various local building acts and by-laws.

The pressures which affected the building regulations - from society, from more complex buildings, new building types and new materials for example - are all duly assessed. As a result, the work reflects upon a number of lesser known facets of the Victorian building world.

The material used has included the Acts and By-laws themselves, commentaries and opinions contained in contemporary journals, papers and reports, as well as the discussion in Parliamentary debate and at the meetings of the Professional bodies. The first three chapters describe three separate routes into the subject : the sanitary reform movement, the legislation in London, and provincial activities. The sequence of chapters then proceeds chronologically, alternating between London and the Provinces, highlighting the principal London regulations of 1844, 1855 and 1894 and the Model By-laws of 1858, 1877 and 1890. The intervening amending Acts and modifications to the By-laws are also included. The principal technical details are collated, tabulated and connecting links established between them.

The study provides, in addition to the detailed documentation and historical interpretation, evidence of the factors which have determined the form of our present building regulations.

**INTRODUCTION**

**DEFINITIONS**

**PLAN**

**PRELUDE**

## INTRODUCTION

The architectural historian may, it has been suggested,<sup>(1)</sup> be in a key position to make a number of useful and relevant contributions to contemporary society. In the first place, he may be able to show that something similar has happened before and that the problems which presently beset society are not so new as may be thought. Secondly, he may help to trace the causes and roots of those present problems and conditions. Thirdly, he may help by drawing the attention of his contemporaries to the framework within which the present problems are being discussed. This Thesis is presented with the intention of making a similar set of contributions in the subject of the building regulations.

In the context of this work, the first of these contributions, namely that a good deal of our present problems are not new, will become more and more self evident as the Thesis unfolds. It needs no further comment at this stage beyond recording the sad fact that complexity, undue interference and confusion have apparently characterised the regulations and plagued the architect for some considerable time in the past.

The second contribution, the tracing of the causes and roots of the present conditions is more substantial and forms the main bulk of the material presented here. A Thesis would normally commence with the establishment of the proposed field of study within the context of work already undertaken by others. In this case, the task is surprisingly simple. With perhaps one exception, there appears to be no single substantial study directly related to the history of the building regulations.<sup>(2)</sup> One may look in vain for a chronological and critical account which attempts to piece together this very diffuse and difficult subject. The one exception is the work of Knowles and Pitt<sup>(3)</sup> but their work refers only to London, is rather slender and strays towards a history of the District Surveyors. On the other hand, building regulations, in the form of acts and by-laws, have been introduced in many other parallel areas of study, as an important adjunct to a particular theme - notably in the study of town planning, urban history, public health and working class housing. In many of these studies the regulations are mentioned where they are relevant to the main subject, but their own developing pattern is never followed through. The reasons for this, and for the fact that building regulations have not received more attention from architectural historians, are not hard

to find.

Firstly, as a subject in itself, the building regulations do not strike any sympathetic chords, least of all in architects themselves. They are seen as cold, impersonal, obscure and negative devices invented by an inhuman and insensitive bureaucracy. Secondly, they have a long history, at least as far back as 1189 in this country, their contents often border on the tedious and they are so intimately bound up with a number of other subjects - law, local government, politics, economic and social history for example. It would obviously be impossible to do justice to the entire history and every detail of every regulation and therefore, in the face of such a daunting task, some form of limitation (as in this Thesis) would of necessity have to be imposed. Finally, it might not be unreasonable to say that earlier studies of architectural and building history have tended to concentrate, naturally enough, on the more obvious development of theory and style at the higher and more attractive end of the architectural spectrum. Within the period covered by this Thesis, this has been to some extent true of the pioneer and valuable work of Hitchcock and Pevsner. But our knowledge of the building world in this period has expanded, particularly with the more recent and significant work of Summerson, Tarn, Dyos and others, and we are becoming more aware of the significance of the greater bulk of anonymous building lying within the shadow cast by the more sophisticated examples of Victorian architecture. It may be argued that the un-selfconscious 'backs' of Victorian buildings are in a sense just as informative about the Victorian attitude to buildings as the self conscious facades. Building regulations are part of this emerging scene - and they tend to have more to do with the anonymous 'backs' than the more fashionable 'fronts'. The nature of the regulations reflects the desires of the society in which they are formed and tend to act as a mirror, reflecting indirectly the world of building. Such is the nature therefore of the second contribution made by this Thesis.

The third contribution, the establishment of a framework in which our present problems are set, is more properly a subject for discussion at the conclusion of a work of this nature, and it is therefore held over until the end. The following pages meanwhile, explain the scope and content of the Thesis in more detail and set the stage for the main body of the work.

## Notes to Introduction

1. Suggested by B.Allsopp, Third Bosson Lecture, Royal Society of Arts. Dec, 1967. "Why do architects need history" R.I.B.A. Journal, vol.75. Oct, 1968. p.472.
2. This lack of any serious historical study of the building regulations is confirmed by R.S.Ferguson in his article "Building Regulations, problems of Tradition and Knowledge", Journal of Architectural Research, vol.4. No.2. Aug.1975. p.37.
3. See Bibliography at end of Thesis for details of this and other relevant works.

\* \*

## DEFINITIONS

### The terms and scope of the Thesis

- 1) The work is written primarily from the point of view of the architectural and building world. The subject of building regulation is however closely associated with a number of other subjects, particularly law, politics, local government, economics and sociology. Reference is made to these subjects from time to time in this Thesis as the situation demands, but specialised knowledge in each of these subjects is not claimed by the author and statements in these areas are therefore made with due deference.
- 2) The term 'building' is used here only as a noun, with the meaning that is most commonly understood, namely an edifice or stationary structure with enclosing walls and roof. Any more precise definition would be difficult and elaborate, especially when, as will be seen, the legislature itself in the 19th century found it impossible to produce a more precise legal definition. The meaning of 'building' as a verb is not included here, and therefore regulations concerning safety on a building site and regulations which may occur as part of a national policy to regulate the amount or the location of building, as in wartime for example, are not referred to.
- 3) Regulations for specific building types which are covered by their own special statutes, such as theatres, cinemas, factories and schools, are outside the main line of the building regulations and although they may be seen at times to be closely related (and references are again made to them as the situation demands), for the sake of relevance and brevity, they have been largely excluded from this work. The same policy is adopted towards standards, particularly those regulating rented local authority housing.
- 4) In addition to 'buildings' however, the regulations for 'streets' and 'drainage' have been included. The topic of streets was intimately bound up with the early regulations for buildings, being seen at that time as a part of the provision of the necessary 'breathing spaces' between buildings, rather than having any relation to traffic factors. Drainage was likewise intimately associated with building and therefore drainage controls within the curtilage of the building have been

included, but not, it should be noted, controls on the main public sewerage system. The subject of drainage unfortunately contains a good deal of rather tedious technical detail which again, for the sake of relevance and clarity, it has been necessary to omit - although all the more essential clauses have been retained wherever possible.

5) Generally only those regulations which affect - or which are themselves affected by - matters of building design and construction are included here. Many of the lengthy regulations which deal with matters of administration, the submission of notices, the payment of fees, with party wall notices, obnoxious trades or dangerous structures have been omitted. Furthermore, only those regulations which are framed either within the Acts themselves or as by-laws or regulations made within the framework of a controlling piece of statute law are included here. Matters of Common Law, concerning "ancient lights" for example, are therefore excluded.

6) The geographical limits are confined to England and Wales. Scotland had, and still has, its own regulations, which are based on a different legal system to that in England. Reference is made at times to Scotland however, and also to other influences from abroad, notably those from France and America.

7) The time limits of the Thesis are set at 1840 and 1914 for the following reasons:

1840, the date of the Health of Towns Report, marks a significant stage in the growing concern with health, a concern which had been emerging in the years preceding that date. It does not correspond with any major piece of building legislation, but it can be taken in general terms to mark the start of the move to graft health controls onto the existing building regulations. 1914 as a terminating date is perhaps rather more obvious. It is a recognisable date in general history, with the outbreak of the Great War marking the end of an era. In our terms it also marks the date of a major enquiry into building by-laws in the provinces and it also sees the virtual completion of the process of the incorporation of the health controls into the building regulations. In terms of London's building regulation however the date is not so convenient, and the pattern here is allowed to run on to include the reinforced concrete regulations of 1916.

8) The main thread of the Thesis follows the more substantial and continuous development of the building regulations as they were generated in nationally produced legislation, particularly in the form of the Model By-laws and in the dominant legislation produced in London throughout the period. Certain other local acts are included, as are a number of examples of the formation and implementation of local building by-laws. These serve to illuminate the text, to show something of the variety of local interpretation, but, with the exception of Sheffield, where the author has more immediate access, undue significance must not be attributed to them. They are examples which the building or architectural journals of the time thought worth recording for the benefit of their readers of the day - they have a newsworthy significance of the time, but no other stronger relationship.

9) The basic source of much of the material presented here is provided by the pages of 'The Builder' which, founded in 1842, covers virtually the whole of the period. Described by one authority as a journal which "throughout its history has clearly and honestly reflected its times"(1), in its week by week account it presented a fine mesh which caught the major part of the development as it emerged. At the same time it provided a source leading to contemporary publications elsewhere. It was of course supplemented by a considerable number of other sources of original material, from Parliamentary Papers and Reports, Hansard, The Times, other building and architectural journals, books and pamphlets - the majority of which are listed in the bibliography at the end of the Thesis.

10) The pattern of the work is shown on the accompanying diagram, (page 14) which also acts as a summary index. The first three chapters discuss three separate but related routes into the main body of the work. After that the work proceeds generally in a chronological order, alternating between developments in London and developments in the provinces. It will be seen that certain chapters can be paired, since they cover virtually the same period of time.

11) Illustrations are graphical rather than pictorial, since it is felt that contemporary correspondence, discussion and court cases reflect a more vivid picture. With reference to the court cases it should be noted that the legal aspects and the validity of the judge-



ments are not the prime interest - it is more the subject of the case, as it reflects the nature of the regulations at the time, which is more relevant in this context.

12) Tables summarising the main regulations are numbered and arranged chronologically, with the connecting links to both earlier and later legislation shown wherever possible. These links are generally made by association of topic, though in some cases direct transfer between one set of regulations and another can be identified. The precise moment of the 'invention' of a regulation is of course almost impossible to determine in many cases, since they were more the result of slow emergence of a concensus of opinion, which an anonymous legal draftsman would later translate into precise terminology. In the Tables the clauses are of necessity abbreviated - the originals, whilst being precise, are far too long for full incorporation, and only the essence of the clauses is therefore stated here. The originals can of course be seen in the Acts themselves or can be traced to their original source by the references given at the head of each Table.

---

1) F Jenkins, 'Nineteenth century architectural periodicals', in Summerson, Sir J (ed), Concerning Architecture, London, 1968 p.158.

CHRONOLOGICAL ORDER OF CHAPTERS AND SUMMARY INDEX

chapter	page	PROVINCIAL REGS. and PUBLIC HEALTH	year	LONDON REGULATIONS	page	chapter			
I	19	Cholera 23 Health of Towns Report	1840						
	30	Lord Normanby's Building Bills							
	35	Enquiry into Regulation of Buildings							
III	45	Enquiry into State of Large Towns	1845	Proposals for amending L.B.A. Analysis of M.B.A. 1844 Streets Structure Ventilation - Drainage	67 71 73 74 77	II			
	125	The Local Act							
	129	Municipal Reform 132 By-laws							
	134	Towns Improvement Clauses Act 1847							
	141	Health of Towns Bill - 145 Public Health Act							
V	147	Local Government Act	1850	Course of M.B.A. 1844 - 1855 M.B.A. in practice	80 86 87 92 99	IV			
	225	Analysis of Form of By-laws	1855	Analysis of M.B.A. 1855 Streets - Drainage Structure Ventilation	162 164 165 168				
	226	Streets - Structure							
	229	Ventilation							
	230	Drainage							
	230	Provincial Building By-laws 1850 - 1875	1860	Course of M.B.A. 1855 - 1875	169				
	240	Developments in Health Legislation	1865	M.B.A. in practice	182 189 196				
	252	Towards a National Building Act	1870	Fire Structure Health					
			1875						
	VI	268	Towards a National Building Act	1875	Pressures for change		342	VII	
273		Introduction of Model By-laws 1876-7							
276		Model By-laws 1877							
277		Streets							
278		Structure							
283		Ventilation							
284		Drainage							
285		Course of Model By-laws 1878-82							
289		" " " 1882-84							
294		Royal Com. on Housing of Working Classes.							
300		Public Health Act (Buildings in Streets) Act.							
301		By-laws in practice, 1886-90.							
304		Sheffield and the Model By-laws.							
308	Public Health Amendment Act.								
IX	441	Model By-laws made after Public Health Amend. Act	1880	Amendment Act 1878 and By-laws, 1879	344	VIII			
	441	Streets							
	441	Structure							
	444	Ventilation, Drainage							
	444	Rural Model By-laws, 1890-1901.					1885	Amendment Act 1882 and By-laws, 1886	349
	451	By-laws in practice, Regional variations, Case studies, 1890-1901.							
	459	Pressures for change, 1902-1914.					1890	M.B.A. and By-laws, 1875-91 Fire Structure Health	367 367 370 371
	466	By-laws in practice, Regional variations, Case studies, 1901-1914.							
	478	Dept. Committee Enquiry on Building By-laws,							
							1895	London County (General Powers) Act 1890 and By-laws 1891	353
		1900	Prelude 1891-4 London Building Act, 1894 Streets+Structure p.406. Ventilation and Drainage	389 403 410					
		1905	Initial reaction to L.B.A. 1894.	508					
		1910	Fire, and the Amending Act of 1905	512					
		1914	L. B. A. (Amendment) Act, 1905.	522					
			Steel and reinforced concrete frame structure and the L.C.C. (General Powers) Act, 1909.	524					
			Case histories, 1895 - 1914.	532					
			Matters of Design and Regulation.	538					

## PRELUDE

In order to provide an outline of the context within which the evolution of the building regulations takes place in the 19th century, this prelude takes the form of a brief review of the more significant factors involved and at the same time acts as an introduction to the three routes which will be taken by the first three chapters of the Thesis - namely via the Sanitary Movement in the first chapter, the legislation in London in the second and the legislation in the provinces in the third. These factors are fundamental and are those most commonly accepted as being valid by historians of the period. Each factor would however, in order to justify its validity, demand separate works of its own. They are therefore accepted here merely as a form of aide-memoire, to refurbish a familiar picture.

The period witnessed an increase in population - a population which doubled between 1801 and the year of the Great Exhibition, 1851, and which was to double again before the end of the period reviewed in this Thesis. Most of the increase was absorbed in the growing industrial towns, the causes of whose expansion was rooted in the economic conditions established towards the end of the 18th century. This expansion was assisted by what is popularly described as the Industrial Revolution, generating industry and trade, with its attendant prosperity and poverty, and which attracted labour from the poorer rural areas and also from a devastated Ireland. Developments in transport further served to encourage trade and the mobility of the people, to facilitate the communication of ideas and to reduce the geographical scale of the country. Altogether there was a rapid increase in the general rate of change, but it was to have its most severe effect on the fragile fabric of the towns, as overcrowding, lack of sanitation, rampant poverty, dirt and disease were to testify. In most towns no responsibility was accepted for this state of affairs and it made little impact on the town fathers or on the medical profession generally. Indeed, to many people it reflected a handsome state of material progress and was seen and accepted as a very natural state of affairs. It could be kept out of sight, kept in its proper place amongst the lower orders of society and out of mind of the upper classes. Cholera however could not be so easily relegated - and it is the incident of this disease which introduces chapter I and the control of buildings as a part of the public

health campaign, the 'Sanitary Question' whose solution so occupied the Victorians.

\*

Turning now to the actual state of building regulation as it existed at the opening of the period under review, mention is to be made in chapter III of the situation in the provinces whilst the business of chapter II is fully occupied with the important developments in London after 1840 - London being the axis in these early years around which much of this account of building regulation revolves - and a brief note must therefore be made here, by way of introduction to that chapter, of the existing state of building regulation in that city prior to 1840.

The great London Building Act of 1774 (14 Geo.III cap.78) was already nearly seventy years old, virtually unamended and still the basic controlling building statute in the Metropolis. This Act, which Sir John Summerson has correctly called "a milestone in the history of London improvement", was largely a codifying measure, bringing together the various strands which stretched back through the Building Acts of Queen Anne to the one made by Charles II following the Great Fire of London - and then even further back to more distant origins in 1189. More comprehensive accounts of these and other related regulations can be found in other works outside this Thesis (1).

The 1774 Building Act related principally to matters of fire control, the restriction of encroachments into the streets and to the control of dangerous structures. Party and external walls had to be of an incombustible material (though the size of openings in the external walls was not restricted) and wall thicknesses were related to a standard schedule of 'rates' according to the different sizes and categories of building. Little ornamentation was allowed, because of the risk of fire spread, except for shop fronts and door surrounds. These restrictions, as Summerson remarks, in fact accorded well with the character of Georgian architecture, but they produced a standardised style of architecture which to the Victorians appeared monotonous and altogether unpalatable, so much so that the Victorians referred to the 1774 Building Act as the 'Black Act'.

The controls on fire reiterated those made in an Act of 1707 (6 Anne

cap.58) which, in banning wooden eaves and cornices, resulted in the use of parapet walls and the controversial requirement for party walls to project above the roof - and an Act of the following year (7 Anne cap.17) set window frames back 4" from the outside face of the wall. The 1774 Building Act made no controls which related to matters of health. There were no controls on the amount of open space related to a dwelling, on the width of streets, on the height of buildings or on the height of rooms - even though these last two matters had had some tentative control under an earlier Act of 1667 (18 and 19 Chas.II cap.8). The Building Act of 1774 was nevertheless of great importance. It established over its long career a machinery for control which was well tried and tested. It established the origins of the District Surveyors and above all it acted as a model for subsequent regulations. The Building Acts in Bristol were closely modelled on it and there were certain similarities with the Acts in Liverpool. When it came to Lord Normanby's proposals for a national Building Act in 1841, it was natural, as we shall see, to find the 1774 Building Act being used as a guide. It was also inevitable that the consideration of the 1774 Building Act in this light should serve to highlight some of its shortcomings and, on the abandonment of Normanby's Bills, to lead to a major revision of the London Act - the subject of chapter II.

\*

The development of local government was one of the major innovations of the 19th century. Without it the generation and operation of the building regulations would have been even more difficult and diffuse. It is the sources and movements in this area which form the third route into our subject and the content of chapter III.

The appalling state of many parts of the denser urban areas showed that any semblance of administrative order in the towns had been left far behind. The extent of the problem and the miserable state endured by the poor was not recognised, or if it was, it was not accepted, and with no accurate statistics being available it was difficult to prove the case objectively. The Civil Service, such as it was, was of little relevance, being largely recruited by patronage, and there was precious little in the way of co-ordinated expert knowledge or experience available. Above all, public opinion really did not expect any form of central Government intervention in these matters. They were not seen to be a part of Government's business, to whom matters of state and

foreign policy were more attractive than involvement with the betterment of the lower orders of society. That was an area which it was understood would look after itself. It would also have been seen as an unwarranted interference with a man's personal liberty, and in controlling buildings it could be seen as an attack on the widely held fundamental belief in the sanctity of private property - a belief that was also sustained by the legal system. Parliament, as the law maker, was largely aloof from these matters and indeed, before the Reform Act of 1832, many of the expanding manufacturing towns had no representation at all in Parliament. The only fear held was that of the mob - a fear inherited from the Revolution in France - but one which was seen by many as a threat, although it was possibly exaggerated, in the growing faceless numbers occupying the slums and rookeries of the towns.

In addition to this uncertainty about the extent of central state intervention and control, there was also a wide disparity between the standards and methods of control at the level of local government and, quite understandably, a long standing suspicion held by the provincial towns of the activities of the Metropolis - a suspicion still held in some quarters today. However, in spite of some obscurity in defining the areas, aims and methods of reform, and in spite of some timidity in execution, the need for reform was slowly accepted. This was to be assisted by one of the more healthy characteristics of the age, namely a willingness to experiment, even if the consequences of such experiments were rarely anticipated. It becomes possible with the benefit of hindsight to look back and to see these trends towards centralisation, standardisation, coherence and uniformity as they underlie the progress of the 19th century, even though at times they are somewhat obscured by fluctuations on the surface.

These general comments must serve as a prelude to the Thesis and as an introduction to the first three chapters in particular.

---

1) There are a number of works relating to the history of London's building legislation, and the following may be referred to:-

a) Knowles, C. C. and Pitt, P. H., 'The History of Building Regulation in London 1189-1972', London, 1972.

b) Davidge, W. R., 'Development of London and the London Building Acts' RIBA Journal, Vol. XXI, No. 11. 11 April 1914 p.333-374.

c) Summerson, Sir J., 'Georgian London', London, 1948.

For other related works, reference should be made to the Bibliography at the end of this Thesis.

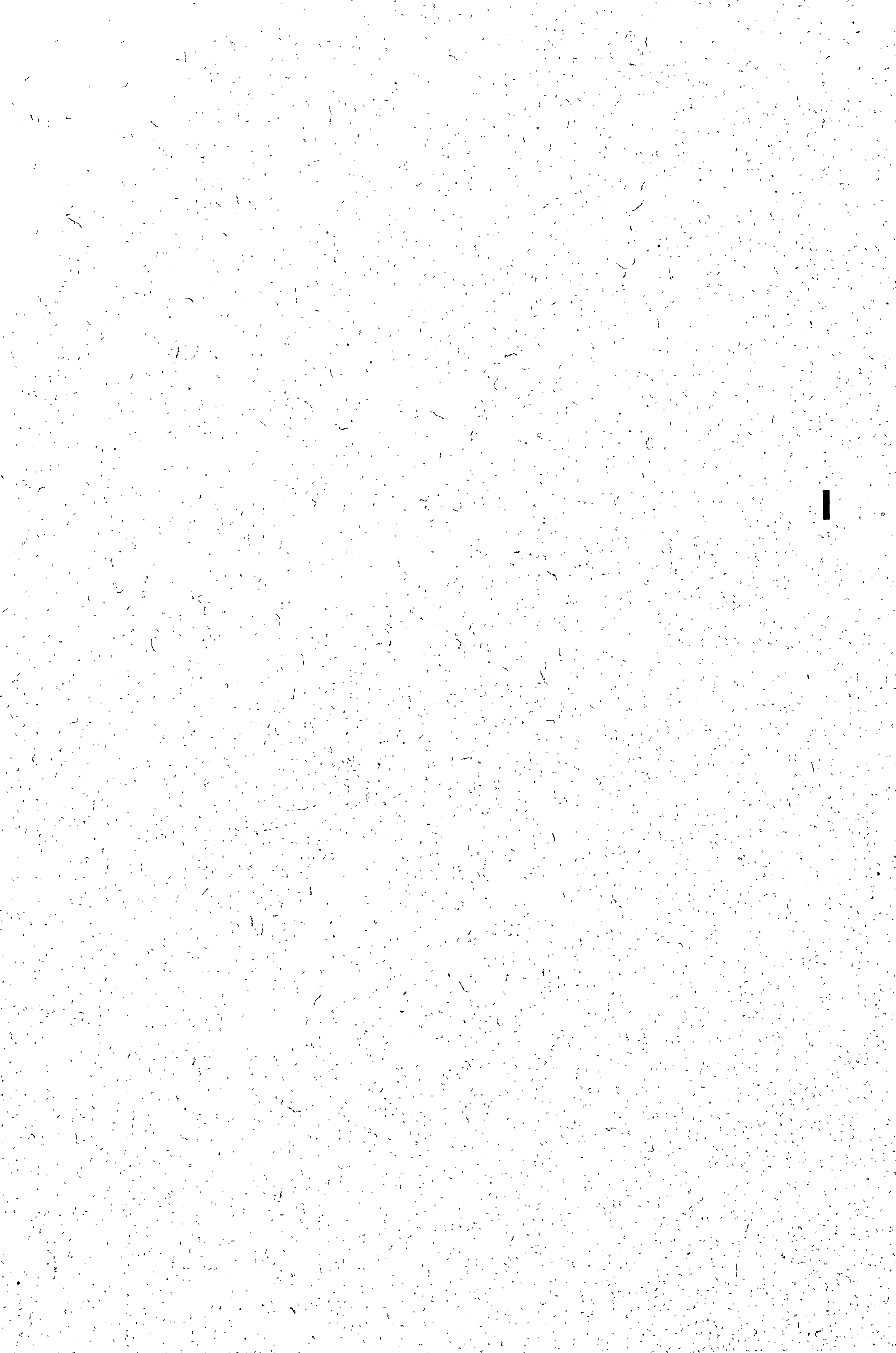

Cholera and Sanitary Reform

Cholera, that insidious disease, was the most fearful product of the appalling insanitary conditions of the densely overcrowded rookeries which characterized the rapidly expanding towns of the early nineteenth century. Coming from Russia, it appeared first in Sunderland in October 1831, but within three months it had spread southwards and had secured a foothold in London. Ignoring the social divisions of society, it could strike at both rich and poor alike, causing panic and fright throughout the country:

"Politics were disturbed, recurrent financial crises bewildering, but the cholera could neither be ignored nor even studied dispassionately. Something had to be done. The memory of the Plague had never been entirely obscured in London" (1)

The first tentative measures introduced to meet this threat took the form of locally established Health Boards, which were granted certain elementary powers of control and which received advice and guidance from a central government department. Such a novel activity on the part of central government was received with considerable suspicion, since any interference with local control, however inefficient it might be, was viewed with alarm and repugnance by the majority of Englishmen. It was not the business of Government to concern itself with such matters. Not surprisingly therefore, once the cholera epidemic had apparently died down the local boards of control were allowed to disband. But the cholera was not dead - it was merely dormant.

Of more fundamental significance in the 1830's were the number of separate, yet often interrelated movements towards the reform of many of the firmly established and archaic institutions of English society. Between 1832 and 1835 for example, there were three very important legislative measures, each of which codified a critical area of reform. The first was the Reform Act itself of 1832 (2), bringing a new political power to the growing ranks of the wealthier middle classes in the expanding towns; the second was the Poor Law Amendment Act of 1834 (3), which set a new pattern of administration based on central



and local control and which, incidentally, brought into prominence the dynamic and controversial figure of Edwin Chadwick; and thirdly there was the Municipal Corporation Act of 1835 (4) which set in motion the formation of the modern system of local authorities. Behind these was the ghost of Jeremy Bentham, the philosophical radical, whose insistence on the universal application of the criterion of utility and whose ceaseless search for logic and honesty in the world of government was embodied in his creed and in the aphorism of the greatest happiness of the greatest number. Behind these movements also was the newly emergent expert, the collector of accurate facts and figures, whose scientific approach to the collection of data and its analysis would result in the reasoned and unemotional presentation of a valid hypothesis.

It was the Age of Reform. Against this background, cholera served to precipitate the campaign for 'Sanitary Reform' - or what we refer to today as the Public Health Movement. Within this movement lie the first clues to a complex pattern of events which result in our present system of building regulation. Before this period of sanitary reform, it should be remembered that the function of building regulation had been limited in the main to the prevention of the spread of fire and the stability of structures - and even then, only the larger towns, such as London, Liverpool and Bristol, had their own Building Acts to control these hazards. A number of other towns, of course, had their local Improvement Acts, but these only involved buildings indirectly, since they were concerned with matters such as encroachments into the street, unguarded cellar flaps or the inconvenience to passers by of rainwater cascading off roofs. These are matters we shall return to in Chapter III.

In this chapter we trace two developments. First the introduction of regulations intended to safeguard the health of the public and the occupants of buildings - regulations concerned with ventilation, drainage and the open space between buildings - and see these new regulations incorporated alongside the traditional controls for fire prevention and structural stability. Secondly, we are following the very first attempts to introduce a comprehensive set of building controls designed to apply throughout the whole country.

\*

In the Whitechapel district of London, a French visitor in the 1830's

noted "partout des mares fétides qui attestent l'absence de toute règle pour l'écoulement des eaux", (5) and it was near one of these "mares fétides", known as Wellington Swamp, that a serious outbreak of cholera occurred in 1838. The local Poor Law authorities appealed for assistance to Edwin Chadwick, the Secretary of the Poor Law Board, and he in turn persuaded the Board to send three distinguished doctors to investigate and report. One of these three doctors, Thomas Southwood Smith, is of particular interest.

Originally a Unitarian minister in Edinburgh, Southwood Smith had established a medical practice in London in 1820. There he came under the influence of Jeremy Bentham and, like Chadwick, became Bentham's close friend and secretary-so close in fact that he was allowed, under the terms of Bentham's will, to dissect his body and to pronounce a funeral oration over it. His medical work was distinguished and in 1824 he was appointed Physician to the London Fever Hospital. He inherited the traditions established by the leading physicians of the previous century, maintaining careful and accurate records of his observations and producing systematic interpretations of his findings. He was the first, incidentally, to introduce the use of illustrations into official reports, realising that Members of Parliament in particular were busy people and could not be expected to read a mass of undigested facts.(6) Referring to Southwood Smith, and his successor John Simon, the historian G.M.Young was to write: "In the career of men like these..... we see the impact of the educated intelligence on the amorphous, greedy fabric of the new civilisation"(7). But not all the medical profession were so enlightened - the reluctance to accept the fact that cholera was not an air-borne disease was to take many years to overcome, long after Snow had first published his proof in 1849. (8)

The conditions in Whitechapel and Bethnal Green were the subject of detailed reports in the appendices to the Fourth and Fifth Reports of the Poor Law Commission in 1838 and 1839. In Southwood Smith's report in the appendix to the Fifth Report in 1839, we see promoted the idea of extending the Building Acts to embrace matters of health, and as such it becomes the first small link in the chain of enquiries, reports and bills which focussed attention on health and buildings in the nineteenth century. But the origins of this subject are now necessarily

distant and somewhat obscure. Southwood Smith was not in fact the first to draw the connection between health and building control - we hear of Henry Belinaye in 1832 for example, recommending building laws to 'assure free ventilation' (9), but Southwood Smith's report can be seen, not as an isolated call, but the first part of the growing and interlinked chain of development.

The following extract is from the last part of Southwood Smith's report:

"There can be no security against the constant recurrence of this calamity [i.e cholera] but the adoption of measures adequate to diminish very materially, if not entirely to prevent, the generation of the febrile poison in every district. This might be done to a large extent by an amendment of the Building Act: by carrying into those districts of the poor, improvements similar to those already completed or now in progress, in the places inhabited by the wealthier classes : by removing as far as practicable the obstacles to a free circulation of air in the closest and most densely populated neighbourhoods: by the construction of underground sewers with effectual surface drainage into them, and by the immediate removal of refuse animal and vegetable matters by an efficient body of scavengers. The expenditure necessary to the adoption and maintenance of these measures of prevention, would ultimately amount to less than the cost of the disease now constantly engendered. The most pestilential of these places, when once put into a wholesome condition, could be maintained in that state at a comparatively small expense: whereas as long as they are allowed to remain in their present condition, the results must continue the same; it follows that the prevention of evil, rather than the mitigation of the consequences of it, is not only the most beneficent but the most economical cause". (10)

The report accepted the fact that the appalling conditions of the poor were not necessarily inevitable, that these conditions were not necessarily the fault of the poor, and nor could they be cured by the poor themselves. Some form of public intervention and control was therefore seen to be required, unpalatable as it might be in certain quarters. It was clear that a constant supply of clean water, adequate sewers, measures to avoid overcrowding, the control of obnoxious trades, as well as the proper regulation of building and the geographical extension of such controls, would all now have to be seriously considered.

The report was widely read and its influence was considerable. In the House of Lords, Charles Blomfield, the Bishop of London, pressed for an extension of the enquiry into the conditions of the larger towns in the rest of the country, a request granted by the Home Secretary, Lord John Russell, and in August 1839 the letter of authorization was sent

to Chadwick and the Poor Law Commission. This was the start of Chadwick's major enquiry into the 'Sanitary Condition of the Labouring Population of Great Britain', a work which Chadwick pursued with thoroughness and relentless enthusiasm, despite the political altercations between the Whigs and Tories, and which eventually appeared, with tremendous impact, in 1842. Almost immediately after the Bishop of London had secured his enquiry in the House of Lords, Robert Slaney instigated a similar enquiry through the House of Commons. A Select Committee of 15 Members of Parliament was ordered on 12 March 1840 to enquire into the Health of the Towns.

The Sanitary Reform movement, and the evolution of the modern building regulations, was under way.

\*\*\*

#### The Health of Towns Report and the First Bill of 1840

The Select Committee which enquired into the Health of Towns worked with commendable speed, interviewed some 47 witnesses during its fortnight long sitting and succeeded, in the space of three months, in producing a Report containing over 200 pages of minutes. It was published in June 1840.(11) Representative witnesses came from both the medical and building world. One name which catches the eye is that of Dr. Duncan, later to become the country's first urban Medical Officer of Health for his home town of Liverpool; another name is that of Thomas Cubitt, a prominent figure in the building world as one of the more organised and enterprising building contractors in London.

The three principal recommendations made by the Committee were for a general building act, a sewerage act and the establishment of a Board of Health for every town. It is the first of these recommendations that we must look at more closely.

The words of the recommendation were: "A general building act, applicable to towns now, or at any future time, comprising a certain amount of population".(12) Although the Committee's terms of reference were confined to the larger towns and mining districts, what they proposed here is in effect a building act for the larger towns of the whole

country, although the figure defining the 'certain amount of population' was not specified. It would therefore have to be produced by some form of central government agency, rather than being locally generated by each individual town. Such central government activity was in itself novel, although there had been signs in the earlier efforts to combat cholera and perhaps more significantly, in the central collection of statistics instituted under the Act for the Registration of Births and Deaths in 1838 (13).

An analysis of the evidence presented to the Committee shows that all who spoke on this topic were in favour of the general building act and saw no problems in its implementation. The London District Surveyors, basing their views on the accumulated experience of operating the still current London Building Act of 1774 (14), anticipated the simple extension of the London system to the rest of the country. The Committee however saw the execution of the new building act being carried out at the local authority level — the level established by the Municipal Corporation Act of 1835. This Act in fact excluded London from its consideration as it was seen to be a 'special situation' and this reason may well account for the later exclusion of London from any general building regulation measure.

James White, District Surveyor for Marylebone, when asked "do you think that there is nothing at all impracticable in a general building act, the particular regulations of which would be carried out by the local authority, but which would be applicable generally?", replied that he saw no objection to this (15). He agreed 'beyond all doubt' that "a general building act would obviate the expense and difficulty and delay arising from the necessity of a local act in each particular case". (16) This particular point refers to the matter of local bill legislation and is taken further in Chapter III (page 124).

It was George Smith, District Surveyor to the City of London South, who pointed out the important fact that "in the neighbourhood of the Metropolis, the London Building Act did not take in many of the places which are growing rapidly in population" (17) Indeed, the existence of a stringent local act was an obvious fact which would encourage a builder to build outside its geographical control and yet, whilst town expansion was not in itself discouraged, it was felt that it must not

be at the expense of escaping control and allowing the construction of shoddy and unhealthy buildings.

James Pennethorne, Surveyor to the Commission of Woods and Forests, agreed that it was desirable to have a general building act that would lay down regulations "to prevent such forms of structures as are injurious"(18). But in his use of the term 'forms of structure' one sees the perpetuation of the traditional thinking of the existing Building Acts. There is no awareness of the importance of the spaces between the forms of structure, the space necessary for the adequate movement of air and the key to the sanitary reformers' obsession with ventilation.

The Committee, after calling for a general building act, limited it somewhat by requiring "the laying down of regulations respecting the construction of certain rates of houses (well understood amongst builders) which are fitted for the dwellings of the working classes"(19). This tended to emphasise housing - and working class housing in particular. It is understandable, considering the identification of the health problem within such areas of working class housing, but it tended to lead in future legislation to an imbalance in the controls, over-emphasising the housing area and giving less attention to other types of building.

"These regulations would" the Report recommended "forbid and prevent such forms of construction specified, as experience and undoubted testimony show to be inconsistent with health. These would embrace 1. cellar dwellings, unless they had areas [i.e open spaces] in front and back, and drains; 2. rows of houses erected in close courts built up at the end and 3. rows of dwellings built back-to-back, so as to prevent any thorough ventilation. These regulations so far would be of a preventive character and would not otherwise interfere with the discretion of builders" (20).

Cellars, as habitable dwellings (or lowermost rooms, as they were referred to in London) will occupy our story as far as the Public Health Act of 1875 and the Public Health (London) Act of 1891. The Proclamation of Charles I of 2 May 1625 had been an early and ineffective measure to prohibit their use. The abortive Liverpool General Improvement Bill of 1802 had also attempted to control them, by requiring the ceiling to be at least 3'0" above the level of the

street outside, as well as requiring an external window and a chimney to the outside. But as Dr. Duncan told the Committee, Liverpool had no such controls (21), but efforts to secure this important regulation were afoot, and they eventually appeared in the Liverpool Building Act of 1842 (22). As an indication of the size of this problem, it is worth noting that Liverpool had 35,000 people (and Manchester 15,000) (23) living in cellars, the majority of which defied adequate description. No regulations existed to control the 'close courts', nor the back-to-back houses, and although some witnesses felt it would be desirable to have regulations to control these forms of building, the interests of the local speculative builders were strong enough to delay their regulation, even as permissive regulations, for many more years.

The Committee's recommendations continued:

"There are, however, a few other rules which ought to be introduced into such an Act, one of the most important is to require that before and behind every row of houses of this description, a certain space should be left open, proportioned to the height of the houses. What this proportion is would be a matter of consideration. Experienced builders, who have given evidence before your Committee (and who are unanimous in opinion as to the necessity of such a provision) differ slightly as to details, one proposing the space in front should be the height of the houses themselves [24], whilst another thinks two-thirds might be sufficient, and in like measure with regard to the space necessary to be left open at the back of these small houses" (25).

Thomas Cubitt however, had some reservations. In answer to the question "do you think that in a building act it would be desirable to provide for the width which the street should bear in proportion to the height of the house?" replied

"I have though so, but, on further consideration, I am afraid that a house would become like a slave ship, with the decks too close for the people to stand up right, they would put the floor and ceiling too near and rather than occasion that I would say that no street should be under a certain width, I should say not less than forty feet" (26).

This raises the point that what the Committee was considering was only the space outside the dwelling; there was no consideration of internal space, the area of rooms or the heights of ceilings at this stage.

Turning to a more delicate matter, the Committee noted

"some provisions have likewise been suggested as proper to be inserted in a building act, which might insure to these humble classes of houses such conveniences as are absolutely necessary for health and decency, and such receptacles for refuse, ashes, etc, as cannot be dispensed with consistent with cleanliness and comfort. There should

also be a sufficient underground drain connecting with a common sewer" (27).

This tentative acknowledgement of the needs of sewerage and drainage - itself a novelty in many thousands of such houses - and its introduction as a topic into a building act is a further reflection of the extension of controls into the health field for the first time.

These therefore are the provisions which the Committee felt to be essential and which were new concepts in building regulation. But the traditional matters of the building acts would still have to be considered:

"Regulations as to the thickness of party walls, to hinder the spread of fires and others to prevent overhanging projections and dangerous chimneys, are now in the Building Act applicable to the Metropolis, and probably in some provincial acts, and would, of course, be necessary" (28).

Having thus put forward these positive recommendations, the Committee felt obliged to consider the problems which might be generated by the introduction of these new measures. The most serious were the interference with the rights of the individual and the sanctity of private property, and the effects on the costs and rents of housing.

The concept of the sanctity of private property was fundamental. The owner of property received a recognition of respect from society - the concept had almost a 'divine right of property' associated with it. As an inevitable corollary of this was the strong opposition to any form of official inspection of private property:

"The regulations would be framed so as to interfere no further with everyone's right to manage his own property than was necessary to protect the health of the community, nor would they extend beyond what the necessity of that urgent duty of Government justified. Such regulations would fall strictly under that rule of public law universally acknowledged which lays down as a maxim "Sic utere tuo ut non alienum laedas" [29]. And again "In these suggestions your Committee have kept in view the policy of interfering as little as possible with private property and no farther than the strict necessity of the case justified" (30).

Such deep concern for this fundamental right is one of the most important aspects of the early history of building regulation, giving it its permissive character rather than inflicting any strong obligatory control. Yet the Committee kept one eye on the alternative view and anticipated the growth of central control when it added that the regulations were "in the nature of strictly sanitary regulations, and are only the fulfilment of one of the first duties of a humane



Government, to protect those who cannot protect themselves" (31). In an age of laissez-faire and the independence of the individual, such an attitude, with its hint of the future welfare state, is particularly interesting at such an early date. The spirit of the doctrine of Bentham was also reflected in the Committee's opinions:

"It may be said that such regulations as have been spoken of, forbidding buildings being erected in certain forms considered prejudicial to health, is an interference with private property. This is doubtless the case, but appears to be amply justified on the plea of the general good, and the same necessity is constantly held to justify similar interference, in various Acts of Parliament, for the construction of roads, railways, canals and in the enforcement of regulations regarding police, quarantine, etc". (32)

The second major objection was again a fundamental matter which has also continued to temper the acceptance of building regulations. These early regulations set higher standards of construction and higher standards of the amount of space around buildings, thereby affecting the density of land use. Both aspects had the effect of raising building costs. These increased costs were borne initially by the speculative builder, but they were then in turn passed on in the form of increased rents to the already impecunious tenants of his property. Evictions, overcrowding and its attendant social evils would, it was feared, lead to an even lower standard of living in the towns.

The Committee's argument ran thus:

"The outlay on the houses themselves in construction and material (which are the main points of cost) might be the same, whether there are twenty or fifteen on the same number of square yards, yet the effect on the health and comfort of the inmates would be very different in one case from the other. Still it must be admitted that if a larger space of ground is required for a given number of dwellings, and they are constructed in a better and more costly manner, and have appendant to them some conveniences which they are now without, that the rent paid for them must be somewhat higher: but your Committee assert with confidence, that this addition will be amply compensated to the working classes by the additional convenience and comfort they will enjoy; and that they will gain in freedom from disease, which now so frequently attacks them and their children, a saving greatly exceeding their outlay" (33).

The character of the 'inmates' would improve, they would be less likely to injure their houses, be more punctual in paying their rent and would require less "watching" (i.e. policing). But the Committee naturally saw no need to improve the lot of the working classes beyond the minimum level necessary to maintain their accepted position and function in the economic society:

"The chief property of these persons is their labour.....the evidence shows how often this (labour) is interrupted by fevers and other disorders, arising from the causes adverted to. Regulation, therefore, which might protect them from these evils, and allow them the uninterrupted advantage of the wages derived from their labour [what these advantages were, other than drink, was not too clear] would make up to them some augmentation of rent" (34).

The problem was much easier to identify than it was to solve. Nevertheless, the Committee Report of 1840 had contained a number of recommendations which were to affect the way in which the regulation of building was to develop. Yet the complexity and interaction within the whole subject had not been properly appreciated - except perhaps by Chadwick, who was then busy gathering facts and assembling his own far-reaching and more intensive Report. Chadwick scathingly dismissed the Committee Report of 1840 as containing "off hand and easy generalisations which could be reduced to little practice" (35). Whilst he had supported the idea of an extended building act initially, Chadwick's views on this particular matter had changed by the time his own Report appeared in 1842. Rather than tinkering with piecemeal regulations for cellars, close courts and back-to-backs, he preferred to stress the faults which lay hidden beneath the system and which produced the visible evidence in the form of unhealthy dwellings.

But we are moving ahead too rapidly and must return to 1840 and the legislative measure that Richard Slaney and Edward Tufnell attempted to introduce following the publication of the Report on the Health of Towns on 17 June 1840. They had both been members of the Select Committee and their short bill, just three pages long, was obviously hastily prepared as an immediate response to the recommendations of the Committee. Entitled 'A Bill for Improving the Dwellings of the Working Classes' (36) its main clauses relating to building matters are summarized in Table 1. It will be seen that it closely echoed the Report's recommendations, following the same sequence and proposing that the Bill should be a nationwide measure. Only the requirement for windows to be openable appears to be an additional requirement to the recommendations in the Report. The inclusion of London would doubtless have led to some conflict with established procedures of the District Surveyors, but such matters were never given an opportunity for discussion. The Bill was too premature and too superficial in its terms. Parliamentary time for its debate was not available and the proposed measure was allowed

to drop. Out in the provinces, certain towns kept a watchful eye on these and the later legislative measures, and one, Liverpool, jealous of its own rights and abilities and anticipating the economic and social consequences, determined to have nothing to do with these national bills and quickened its pace in formulating its own local Building Act - an Act which appeared in 1842 (37) but which even so, contained a number of clauses whose origins can be seen in the recommendations of the Select Committee.

Meanwhile, the initiative in Parliament moved back to the House of Lords. At Southwood Smith's instigation, Lord Normanby, the Home Secretary in Melbourne's second Whig cabinet, had undertaken a tour of the slum areas of London in 1840. Confronted with these revelations he became a convert to the cause of Sanitary Reform. Having read, so he claimed, every word in the Report of the Select Committee enquiring into The Health of Towns, Lord Normanby introduced a bill into the House of Lords in January 1841 (38) entitled 'An Act for the better drainage and Improvement of Buildings in large Towns and Cities'. This Bill forms the next link in the chain of developments.

\*\*\*

#### Lord Normanby's Building Bills of 1841

The principal contents of Lord Normanby's first Bill of January 1841 are summarized in Table 2. It received its first reading in the Lords with little comment, but by February some doubts were beginning to be expressed. Lord Ellenborough regretted that it was not retrospective and that it took no steps to secure 'a more free ventilation':

"The Marquis might have been deferred in the framing of his measure by an apprehension of interfering with what were called 'vested rights'. I do not think that reason sufficient. No man should be at liberty so as to abuse his property as to effect the health and endanger the lives of the community". (39)

He sought a wider scope for the Bill and more stringent enactments. Normanby evaded the issue of 'vested rights' and concentrated his reply on the aspects of health and the construction of houses, quoting Pennethorne's evidence to the Select Committee on the Health of Towns with regard to narrow courts and shoddy construction, and Dr. Duncan's statistical evidence of the distress caused by the 'subtle poisons

which affected the vital energies' and the 'air saturated with malaria' (40). But the Marquis of Salisbury would not let the matter of 'vested rights' drop and continued his protestations. He was followed by the Earl of Wicklow who, whilst supporting the Bill in general, was concerned in particular over clause 25, feeling that the control of room sizes was unnecessary if measures for sufficient sewerage and proper ventilation were secured (41). Together with the Marquis of Northampton he was also concerned about Clause 22, considering the proposed street width to be insufficient (42). Cubitt, it will be remembered, had suggested 40'0" in his evidence to the Select Committee. They were also concerned at the lack of any control over the relationship between the height of buildings and the width of streets.

Objections were also raised outside Parliament. The Editor of the journal 'Justice of the Peace' for example, whilst agreeing that the measure was of "paramount necessity" added "whether this is the one best calculated to effect the object, is very questionable". In the first place, the powers of implementation were to be left in the hands of the inefficient Commissioners of Sewers -

"the lethargic motions of the Commissioners of Sewers which stagnate together with the motionless pools of putrescence that have been so long accumulating before their eyes";

and secondly there were the economic consequences of the controls as they affected the costs of the houses, throwing additional burdens of expense on the tenants - "Houses must be built according to the pecuniary ability of the tenants, to attempt anything beyond is futile and will be ineffectual". (43)

The Editor of 'The Times' also took the Bill to task. Whilst agreeing that it was "a measure of incalculable practical importance", he noted that "it contained provisions of a very mixed character" and was extremely concerned at "some vexatious matter contained in it". He felt that Normanby had gone far beyond the terms outlined in the Select Committee Report. Three areas of control in particular were singled out for criticism. First there was the extension of the controls to include small towns and villages - The Times saw no proof that such controls were necessary in these places. Secondly, there was a requirement for the occupier of an existing house to build a 9" diameter barrel drain in brick or stone. Ignoring the merits of small bore drains, it was

considered to be very unfair to throw the extra charge that this would cause onto the poor occupier of the house. Thirdly, and more significantly, was the increasing interference with the rights of private property:

"Lord Normanby proposes to settle, by Act of Parliament, the size of rooms and the height of windows . This is monstrous. A construction is enjoined, which in all probability does not generally prevail in any village in the Kingdom, and which is departed from continually without the smallest risk of injury to the health of the inhabitants or their neighbours. We should have thought that none but the veriest cockney could have drawn such a clause. A man cannot build, nor alter or divide a room in his house without risk of having it pulled down. Yes, incredible as it may appear, pulled down. This reckless and wanton invasion of property and liberty is proposed by a Liberal Government in the 19th Century, and in a country where everyman's 'house' was formerly said to be his 'castle'. Any unfortunate workman who may 'wilfully, carelessly or negligently make a window an inch too small, or a room a foot too small, is to be visited with heavy penalties. The impossibility of carrying out such inquisitorial enactments into effect must strike everyone, their vexatiousness is equally evident, they would be a source of additional and needless outlay to the builders of cottages, which would be exacted again from the poor occupiers in the shape of additional rents. We feel that by exposing such clauses we have already done enough to prevent their ever becoming law". (44)

This was indeed to be the case. Room sizes did not reappear in the revised Bill (although they were to appear elsewhere - in the Liverpool Act of 1842 for example) and window sizes were similarly excluded, except in the case of cellar windows.

Following the second reading in the House of Lords in February 1841, the Bill went to Committee, through its Report stage on the 1st April (45), and then, rather belatedly to a further committee stage on 23 April, in which the original Bill was divided, and a separate 'Building Regulation Bill' drawn up (46). It was considerably revised and re-written, and extended to incorporate most of the traditional matters of the existing London Building Act - (The course of the other Bills for the Improvement of Boroughs and the Drainage of Towns ran parallel to the Building Regulation Bill, but they do not directly concern us further). A Report was received and the Bill was read for the third time on 4 May (47). Three days later the Building Regulations Bill moved to the Commons, but after its first reading and report, it was delayed by more pressing parliamentary activity in other areas. In answer to Viscount Sandon's question on 28 May on the future of the Bill, Lord John Russell said that there were still certain points

which required attention "and would probably create a lengthy discussion and it was not his intention to press the Bill this session" (48). It was withdrawn on June 8.(49) Upstairs, the Earl of Wicklow asked Lord Normanby what had happened to his Bill. He replied that it had been abandoned "since the session had terminated earlier than had been expected"(50).

In August 1841, Lord Normanby tried a second time to secure his Bills, even though the Whig Government was ailing fast. It is possible that he thought these measures would have sufficient popular appeal to halt the Government's decline. It had completed its three readings in the Lords by 30 August (51), but in September the Government finally fell, and the Bill was again lost. The change to the Tories brought the cautious Sir James Graham to the position of Home Secretary.

February 1842 saw the start of Lord Normanby's third attempt, but opposition came now at the second reading from the Marquis of Salisbury. He felt that "in its details it tended to perpetuate the very evils it professed to remove" (52), since any regulation which enforced the erection of better houses would necessarily increase the cost of building and increase the rent burden of the poor. Normanby was not deterred however, and the Bill passed its third reading and moved then to the Commons (53). Here it encountered further setbacks. The Speaker claimed that the Bill contained provisions "as coming from the Lords, which were inconsistent with the privileges of the Commons". Fox Maule proposed a postponement of the second reading until July, but did not oppose a proposal for the Bill to be examined by a Select Committee of the Lords. Lord Ashley regretted this possible postponement "due to some informality" and Viscount Sandon nervously hoped "that they would proceed cautiously, lest, while in pursuit of certain remedies for admitted evils, they aggravated instead of curing them" (54). The postponement was agreed to and, on 3 March 1842, a Select Committee was appointed to consider the "Regulation of Buildings and Improvement of Boroughs".

In the event, in spite of drastic pruning following the Select Committee's enquiry, Lord Normanby's Bill was not taken further. Its contents were absorbed in a new Building Bill for London only, proposals for which had been under consideration since the previous year, and which eventually

passed into law as the Metropolitan Building Act of 1844 (55). (This is the subject of Chapter II).

The only person to gain any satisfaction from the delays to Lord Normanby's Bill was Edwin Chadwick. Not only had Normanby put a temporary stop to his own enquiry in January 1841, but Chadwick had fought the Building Bill all along, considering that it contained outdated technical requirements and was based on faulty premisses. It avoided the major issue of a really significant administrative re-organisation which was clearly necessary before the details of building regulation could be properly considered. "Concocted by Home Office Lawyers and Palace Architects" (that is, the Department of Woods and Forests) was Chadwick's phrase (56).

The delay caused by the Select Committee enquiry between March and June 1842 gave Chadwick time to complete his own report - which duly appeared in July. Of such an impact was this Report (57), so fundamental and wide ranging in its span of enquiry, its detail and its recommendations, it is not surprising to find that attention was turned away from small scale details of regulations out to the whole spectrum of the sanitary reform movement. Building regulation was mentioned by Chadwick, but with a different and new emphasis:

"The most important immediate general measure of the nature of a Building Act, subsidiary to measures for drainage, would be a measure for regulating the increments of towns and preventing the continual reproduction in new districts of the evils which have depressed the health and the conditions of whole generations in the older districts" (58).

The report quotes the evidence to support this : from Thomas Cubitt again, reiterating the fact that builders would move outside the control of the London Building Act to continue building shoddy dwellings (59) and from George Gutch, a District Surveyor, who quoted four-storey tenements in Kensington with only 9" thick walls, built outside the control of the Building Act (60). The Act had stipulated 14" thickness for walls above the basement.

Whilst not wishing to under-estimate the importance of Chadwick's Report in the larger story of the public health movement, it is necessary for us to dwell a little longer on Lord Normanby's Bill. Although it never passed into law, it forms a significant step in the evolution of a national set of building regulations and the contents

of the Select Committee Report of June 1842 which enquired into the Bill serve to illuminate the theory and practice of building regulation at this time.

\*\*\*

The Select Committee Enquiry into the Regulation of Buildings 1842

The membership of the Select Committee which enquired into Lord Normanby's Bill between March and June 1842, together with the names of the witnesses interviewed, is given separately (61). The following analysis of the Bill (as it was on 5 May 1841) is illustrated by examples from the evidence presented to the Committee, the sequence of clauses as they appeared in Normanby's Bill is re-arranged so that they can be more conveniently and logically considered under the broad subject headings of cellars, streets, structure, ventilation and space about buildings and drainage and the clauses are shown on the accompanying Table 3.

Before turning to detail, certain general points need to be made. The Bill was originally intended to be a national measure. It was generally agreed by the witnesses that the time was right for a new Building Act, one suitable for the whole country, and, as one witness considered, for the whole Empire (62). It was to apply to all the Borough Councils, as defined under the Municipal Corporation Act of 1835, including those in Ireland and Scotland, but certain sections of the proposed Act were to be excluded from operation in London, Liverpool and Bristol - towns which already had their own Acts covering matters of fire, stability, party walls and projections.

It soon became apparent in the course of the enquiry that the Bill had certain anomalies and shortcomings. There were conflicts with the existing provisions of the London Act. Clause 13 for example, requiring dwellings below ground level to have an open area, did not feature in the London Act (63). On the other hand, London had provisions for the establishment of fire engine keepers and fire cocks, matters which were not included in Normanby's Bill. Again, Normanby's Bill made no distinction between brick and stone construction for walls, yet Bristol



(64) had separate schedules for wall thicknesses for the two materials (65). Sizes for timber joists, purlins and rafters had been a feature of the Liverpool Acts from 1825 onwards (66), and had been in the London Act of Charles II (67) but no mention of timber sizes appeared in Normanby's Bill. Improvements in construction were overlooked. One witness felt that practice of inserting timber into party walls was unsafe and that the ends of the timbers should be carried on iron shoes (68). Following the ban on boys for chimney sweeping, new mechanical devices for sweeping were being promoted. The Chimney Sweepers Act of 1840 (69) set a flue dimension of 14" x 9" and the thickness of a withe (the dividing wall between flues) at 4½". With the prospect of cleaning machines "armed with whalebone" it was feared that the withes would soon be eroded and it was hoped that Normanby's Bill might have made an allowance for this (70). No attempt was made either to amend or compensate for the other piece of legislation which impinged on building design, namely the harsh and archaic Window-Tax. One witness called for the need for light and ventilation to small internal rooms, but the Bill made no provision for this, except for cellars, and for the sake of health such a measure was obviously necessary (71). (Liverpool, in its 1842 Act, was currently calling for every room to have an outer window as well as specifying a minimum ground floor room area of 108 sq. feet (72).

Local legislation and regional variations in building practice were also ignored. Manchester was content with 4½" thick party or division walls (73) yet here was Normanby's Bill calling for 13½". Manchester was noted, then, as now, for having a damp climate:

"The strength of the houses is commonly thrown into the outside walls, rather than into the division walls, because when the additional brickwork is placed there, it protects the house from the rain : in drier climates they probably would throw more strength into the division wall. On the ground storey, they generally build them with a cavity to keep the damp out, there is a cavity between the two courses to prevent the damp coming through, it would come through a 1½ brick [13½"] solid wall : there being that space, keeps the room dry" (74).

This is an early reference to a practice now accepted generally, but one which was unusual at the time and not surprisingly therefore the legislature saw fit to ignore it.

Whilst London and Bristol took the party walls not only up through the roof space but out above the level of the slates as parapets to prevent fire spread, Manchester did not even take walls up into the roof space.

Long garrets were a traditional feature, being occupied separately from the rest of the house below. They were used as schools, as workshops by the textile workers and even, we read,

"The Guardian printing office, a well known Manchester newspaper, is in an upper room, the garret of a considerable block of buildings".(75)

Finally, there were developments in the design of buildings which it was feared the Bill would hinder. Shops, for example, were introducing the concept of the double height shop front. Two witnesses identified this restriction in the Bill:

"Bressummers [i.e lintels or beams] that shall be fixed not higher than the ceiling of the ground floor. That is usually the case, but in these improving times we find bressummers run up almost to the parapet of the house, there are several houses being built in which instead of confining the shop front to the level of the first floor, the object is to take in more than one floor in the same shop front and that would entail the necessity of throwing the bressummers up to the second floor. There is no object gained by this clause but you prevent improvement" (76).

These examples must suffice to show the range of matters discussed before the Select Committee and illustrate some of the ill-considered regulations drawn up by the 'experts at the Department of Woods and Forests'. We can now look more closely at the detailed clause under the various topic headings.

\*\*\*

#### Cellars (Table 3, sheet 1)

To meet the obvious hardships which would result from the sudden displacement of people currently living in cellars below the new standards after the Act came into force, the rules were to be applied in stages. No cellar without a window was to be let after 1 Jan 1844, without a window or an area after 1 Jan 1847 and without a window, area and fireplace after 1 Jan 1850.

Liverpool was ahead of London in this matter. It had already drafted a bill (which became their 1842 Act) containing clauses requiring a minimum cellar height of 7'0", one third or 2'0" minimum of which was above the level of the street; an open area 2'0" wide in front of the cellar and an openable window not less than 3'0" square. The London

witnesses were reluctant to accept these measures. They were not in their existing legislation. If it was introduced they asked for the area to be 6" below the level of the cellar - presumably to prevent water running back into the room (77). The Liverpool men in turn objected, they could see no necessity and consequently that requirement was not in their proposed Act. A London builder wanted the word "open" removing from the clause because, although an allowance was made for an archway over the area to gain the necessary access to the front door of the house, he saw no objection to the extension of parts of the cellar dwelling into the area - "such as the butler's pantry, as seen in the gentlemens' residences in Portland Street" (78).

Then there was the effect that this open area, 3'0" wide in the Bill, would have on shops, - traditionally at this time the ground floor of a "house". It would, it was feared, be inconvenient for trade, since it would have to be surrounded by iron railings with the shop window being set too far back from the pavement. Iron gratings were suggested as an alternative, as in the houses in the Edgware Road, so as to allow people to approach the shop window (79). This respect for the influential power of trade and commerce, in a growing nation of small shopkeepers, could not be underestimated and it is one we shall encounter again later. 3'0" wide for the "area" was felt to be excessive - "it would be used as a common privy" (80). But the Committee, in its later deliberations, proposed 4'0" and even 5'0". A vote was taken within the Committee on this issue on 10 June. The result was an even split in favour of both dimensions. The Chairman cast his deciding vote in favour of 4'0" and so that dimension came through in the revised Bill. Such was the manner, no doubt, in which many of these technical issues were determined.

\*\*\*

### Streets (Table 3, sheet 1)

Streets were classified either as 'carriageways' or for "foot passengers" only. The dimensions of street widths have a long history of varying standards, before they settle eventually in the Model By-laws of 1877 as 36'0" and 24'0" respectively. Normanby's Bill set dimensions which were not too far removed from the 1877 standard, and indeed, his

dimensions were to be maintained in the Towns Improvement Clause Act of 1847 (81). (see Chapter III page 135). But Normanby's first Bill set 25'0" for carriageways and Liverpool was currently proposing 24'0" for its Act of 1842. This may have been influenced by Manchester, where the Improvement Commissions Act of 1830 had called for no street or court to be less than 24'0" (82). The Liverpool Surveyor explained that 24'0" was chosen since it was sufficiently wide to allow two 7'0" wide carriages to pass each other comfortably and allowed 6'0" for foot paths, and also because it was felt that it was the right width in relation to the height of the houses in Liverpool, which were generally three storeys high. He agreed however that 30'0", as proposed in Normanby's Bill, was more suitable to the taller houses in London (83). This need for the establishment of some relationship and control between the height of buildings and the width of streets was still felt by many of the witnesses to be important (84). It had existed in a simple form in the London Act of 1667, in the City only (85), but although the issue had been raised in Parliament the year before (see page 31) it was never introduced into Normanby's Bill. It will be recalled that Thomas Cubitt had suggested 40'0" - a Birmingham Commissioners Act even set a width at 42'0" (86) - and it was 40'0" which was to reappear in the Metropolitan Building Act in 1844.

With regard to courts and alleys, it was intended to establish controls to prevent the erection of "close alleys", that is, alleys and courts so built up at the ends to result in a lack of through ventilation. The Committee wondered if the dimensions of 30'0" and 20'0" should be reduced to 24'0" and 15'0" respectively, but it was felt that, with two storey houses being approximately 20'0" high, the minimum court width should remain at 30'0". In Liverpool however, the Surveyor considered that 15'0" was satisfactory (87), the scale of building being lower than that of London, and he also saw no need for the court to be open at both ends, as Normanby's Bill specified (88). This was to be the regulation incorporated in the Liverpool Act of 1842. The lower standard of Liverpool was further emphasized by the fact that it was possible for the entrance to be narrowed to 6'0" by the placing of privies, not over 10'0" high, at the entrance. The Birmingham Surveyor also objected to the standard in Normanby's Bill. Courts open at both ends would increase building costs - "it would knock up

the building of such houses and interfere with the accommodation of that class of people in Birmingham" (89).

\*\*\*

Structure Table 3, sheet 1

The requirement for walls to be of "good, sound, well burnt bricks or good sound stone, properly bonded and set in good mortar or cement" was a long established requirement in the Building Acts of London, Liverpool and Bristol. (Bristol incidentally included the rather unusual requirement for walls to be perpendicular). Timbers were allowed in certain situations, notably in the traditional practice of inserting bond or chain timbers within the wall itself, for joists, partitions, lintels, frames, bressumers and storey posts. The specification of mortar departed from the Liverpool standard (90) of 1 part of cement to 2 parts of sand, but in Scotland, where the Bill was also to apply, it was noted that "there are scarcely two limes in Scotland which require the same quantity of sand, therefore that part is quite useless" (91). All timbers to be set back  $4\frac{1}{2}$ " from the face of the wall was the same as in Liverpool and had been a feature of the London Act for many years, although the precise dimension there was 4".

Clause 31, regulating the size of openings in warehouses and shops to 10'0" followed the Liverpool standard, although Manchester usually had goods entrances up to 12'0" wide (92). The use of iron was increasing, Liverpool permitting storey posts and bressumers in shop fronts to be of cast iron "with sufficient caps and base plates" (93) and it was pointed out that with the introduction of iron beams "you may have three times 10'0" without a storey post and be strong enough".(94) Once again, the Bill was conservative, reluctant to accept any relatively new and experimental technical possibilities. Clause 32 was more stringent than both Liverpool and London, where  $4\frac{1}{2}$ " and 4" respectively was considered satisfactory.

Rather surprisingly, there was no mention of foundations in the Bill, although they had been specified in the first draft (Table 2, clause 23). The idea of a separate strip foundation does not reappear for a number

of years. Footings however, in the form of stepped brickwork were now indicated in conjunction with the schedule for wall thicknesses. There was no reference to the proper preparation of the site itself, nor any direct reference to a damp proof course, although clause 20 introduced the dimension of 6" for the level of the ground floor above the level of the adjoining footpath or roadway. This rule was also the result of the speculative builders' practice of building houses directly on the turf in a field, before the line or level of any road or drainage had been established (95). The 6" step was considered reasonable for houses, but once again, the opposition of the shopkeepers was feared, since any form of step was considered to be of great inconvenience to customers (96).

Parapet and party walls projecting above the level of the roof, clause 33, was an established requirement in the existing Building Acts and its effectiveness in preventing the spread of fire was generally accepted, though not by all. One witness thought the parapet to be 'an unnecessary hardship' (97) and another, the Birmingham Surveyor, thought they were unnecessary in small houses. But if they were included then he felt they should be higher - "the flame will lap a 12" parapet" - and he was troubled by the very real problem of wet penetration at the base of the parapet. They were, he added, an uncommon feature in Birmingham (98).

Projections beyond the 'line of fronts' were prohibited under clause 44, with certain exceptions as shown in Table 3. Many towns had local Improvement Acts to control projections, both from the point of view of safety to passers-by and to reduce the spread of fire from one building to another. The Bill set no dimensional limits to the extent of most forms of projection and concern was expressed that this would constitute a great nuisance in towns which did not have a local act to control them - Birmingham, for example, set a maximum of 14" for projections (99). Restrictions on shop stall boards and cornices were however included, based on the London practice. Liverpool had even more stringent regulations for these features.

The business of projections was always a source of contention. Sir John Soane's House had encountered a problem in this respect in 1812 (100) and many cases were to occupy the magistrates' courts in later

years. In an age when the picturesque delight in ornamentation was to receive encouragement from the revival of the Gothic style, as well as the use of elaborate cornices in the revival of the Classical school, the possible detrimental effects on 'street architecture' were viewed with apprehension.

Cutting into party walls, clause 47, raised an interesting discussion in the evidence to the Committee. The general introduction of the watercloset, in more fashionable circles, brought with it the inevitable problem of incorporating the large and unsightly - and noisy - supply and drainage pipes. The waste pipe was frequently inserted into a chase in the party wall, the neighbouring house doing likewise and as a result the wall's strength was considerably reduced. And where it crossed a bond timber, a hole was simply cut in the timber, further reducing its effective strength. It was stated that the pipe could not go outside 'as you could not get at them, the pipe being immediately under the w.c.(101). Furthermore, with joists being 10" deep:

"you would have to carry the waste pipe horizontally for 10' to 15' before reaching the outside and it would be continually stopping up"....." And if taken down the inside face of the party wall, it would very likely come through the Drawing Room and would be a disfigurement"(102).

The w.c. was still a discreet internal device - the idea of a separate room, preferably on an outside wall was not conceivable within the traditional Georgian concept of a house. Inevitably therefore, it was to become an additional room, added to the back of the narrow fronted, deep terrace house.

Roof construction, clause 42, perpetuated the requirements of the established Building Acts as did the next clause concerning the proper disposal of rainwater from the roof - although at least one witness could see no good reason for the exception made in the case of porticos and shop roofs (103). (This control of water from roofs also has a longer history in many local Improvement Acts, see Chapter III page 126).

The construction of chimneys, with its long series of regulations, clauses 34-41, was another area where the origins can be seen in the earlier Building Acts.

Normanby's Bill however introduced certain changes and not all of them were welcomed by the expert witnesses. The increase in the thickness

of the back wall of a flue at the chimney opening was considered unnecessary. The old rule had worked well enough and all that would result would be the further intrusion of the chimney breast into an already small room (104). The matter of the withes and the mechanical sweeping of chimneys has already been referred to. The limit of timber to a minimum of 9" from the inside of a flue (clause 36), whilst close to the London standard, was more severe than that in Manchester. There it was considered that "4½" would be plenty safe against fire" (105). The height of a chimney, clause 39, was also felt to be too severe. One witness thought the whole requirement to be absurd (106), another saw no objection to a height of 9'0" (107), yet the Liverpool Act of 1825 had been more severe with a control set at 4'0". The pargetting of the inside of and outside of flues, clause 40, raised the obvious point that such a requirement would deface the appearance of the end or corner house (108). The quaint regulation for painting the lines of flues on walls, clause 41, should be noted here. It disappeared from building legislation but reappeared many years later in the London Building Act of 1894. (see chapter VIII, page 409)

\*\*\*

Ventilation, Space about Buildings and Drainage (Table 3, sheet 3)

Clause 17, preventing back-to-back houses, was new. It had appeared in the first Bill but it faced considerable opposition in the evidence presented to the Committee, and it was not to reappear in their modified Bill. Objections came from London, Birmingham and Leeds (109). It was felt to be extravagant and it would be difficult to implement, particularly on corner sites, where much valuable land would be lost as a result. Similar objections were raised to clause 23. It was 'not practical' for Liverpool - court houses would have to be exempt anyway and the requirement of a privy for every house was felt to be over generous (110). One privy to every four houses was felt to be quite sufficient (111). The yard provision would add materially to costs (112) and another witness said "no corporation could afford to purchase property and carry through a new line of street sufficient to afford space for building sites and yards behind - it would be quite impossible" (113). Two witnesses however supported the provision of



yards, recommending them for all houses and proposed a schedule. Fourth rate houses were to have yards of 50 sq.ft, Third rate to have 70 sq.ft, Second rate to have 100 sq.ft, and First rate to have 150 sq.ft. They did not think these provisions would add materially to the rent (114). Another agreed that the privy should be provided to each house and optimistically hoped that water would be laid on as well (115). On matters of drainage, however, the Bill was notably quiet. The significance of bad drainage was not fully understood, The emphasis in this Bill was on the removal of bad air - that rather than water, being seen as the medium through which disease was transmitted. Nevertheless, it should be remembered that the Health of Towns report of 1840 had made a point of mentioning, though somewhat tentatively, the need for proper drainage.

Internal ventilation of dwellings was covered, not, as in the first Bill, by reference to window and room sizes, but only in the control of room heights. Certain witnesses however still felt that room sizes should be included (116) and it is worth noting that Liverpool was currently incorporating a minimum room size of 108 sq.ft, in its own Bill.

The issue of room heights was as controversial then as it is today. The restriction of 7'0" in the upper storey was opposed:

"I would not allow any room to be less than 8'0", for in the upper part of the house you feel the heat of the roof, and it is much worse than other part, and especially in the sleeping rooms, and 8'0" is not an inch too high" (117).

One witness proposed revising the order, making the cellar 7'0" (as in Liverpool) and 8'0" elsewhere. The advantage then was you would have "far more fall on your drain where you are pinched" (118). The control of one storey in the roof, clause 22, was generally accepted, but there was some confusion in terminology between the 'upper storey' and the 'attic'. If the upper storey meant a garret or attic, within a curbed roof for example, then the London witness was prepared to consider a lower ceiling height than 7'0". "For many garret storeys are not more than 6'6" or 6'9" in tolerably good houses" (119). Asked to be more specific, he replied "not less than 6'9". As to whether that 6'9" should be to the lowest or highest point under the roof he concluded that "the average would be the best way to take it, nothing should be less than the average of 6'9" (120). This appears to be the beginning

of that awkward rule which controls the height of a room under a sloping ceiling and which, in a modified form, is still with us today.

Finally, it must be noted that a regulation requiring ventilation below the ground floor joists was not included, although it had been in the first Bill - see Table 2, clause 24. This is another matter which disappears temporarily from the story, but which reappears in the later Model By-laws in 1877.

\*\*\*

The Royal Commission Enquiry into the State of Large Towns and Populous Districts, 1844-5

The Tory Home Secretary, Sir James Graham, inherited Lord Normanby's Bill and quickly terminated its course. Early in 1843 he announced that the whole of the public health matter, now brought into further prominence by Chadwick's work, was to be referred to a Royal Commission. At the same time, it was announced that a new building bill for London was to be introduced (121). The Earl of Lincoln had consulted with various architects and surveyors and "looking at the complication of details, and the number of towns, such as Liverpool, which had local acts of their own, he felt that any general measure would be inapplicable to different places" (122). So ended the first attempt at a national building act. The course and contents of the new London Bill are followed in the next chapter; we must meanwhile turn to consider the implications of the Royal Commission's Report.<sup>(123)</sup> Published in two parts in 1844 and 1845, the Report reiterated most of Chadwick's findings, stressing the need for health controls, in particular now proper sewerage and cleansing, an efficient water supply, the establishment of single local authorities under central control and the appointment of Medical officers of Health. These matters form part of the history of the public health movement and form the link with Chapter III. Within the Report were also certain detailed recommendations which bear more closely on building regulations.

Courts and alleys were recommended to be a minimum of 20'0" in width, with an opening not less than 10'0" wide, open from the ground upwards,

at each end of the Court, and the width of the court was to be in proportion to the height of the houses. This last proviso is important, reintroducing the concept of a relationship between the height of a building and the space before it (124). But regrettably the Committee now saw no objection to back-to-back houses. The mere provision of open space at the back as well as the front offered, it felt, "little security for a due supply of fresh air in the interior, while the addition of another outer wall, besides enhancing the cost of the building, increases the surface exposed to damp and cold, which readily penetrates through the scantily constructed walls of inferior houses" (125).

This was a severe setback, reflecting the underlying repressive pressures of entrenched opinion. Controls on cellars however, in line with Normanby's Bill, were recommended for extension to the whole country, as was the provision of privies to all houses (126). Both these matters eventually appeared in the Public Health Act of 1848. Turning to the structure of buildings in relation to fire, the Committee's recommendations make surprising reading. It was concluded that it was "unnecessary to interfere with the minute details of building for the poorer classes in the great majority of towns in England and Wales" (127). They saw no evidence of fires occurring in the houses of the poor, where there were no regulations concerning party walls - due, it was said, to the rooms being rarely unoccupied and to the small quantity of firing generally in use. There was no need for any regulations - it would only increase costs. It was too early, they felt, to see the effects of the recent Acts in Liverpool and Bristol, and the stringent requirements on timber sizes at Liverpool were noted with great concern.

On ventilation, the Committee were more loquacious. Poor ventilation was the cause of all the evils, and the scientific control of this element would be the salvation of the poorer classes. They wrote at great length on this - part is quoted below:

"The advanced state of medical enquiry has led to a conviction of the vast evils consequent upon breathing vitiated air.....it is now well ascertained that living in such impure atmospheres induces consumption, renders the constitution more prone to, and less able to resist, the attacks of diseases of various kinds, especially fever, and by depressing the physical energies causes a resort to stimulants, resulting in habits of intemperance. A minute examination of the circumstances of the case has assured us that no field of improvement holds out a more promising result than that which may be anticipated in future from the more successful ventilation, even of the humblest dwellings" (128).

They dwelt on the balance of warm air against the replacement of vitiated air, without causing draughts - "The poor are particularly sensitive to currents of air". Methods of warming and ventilating should, they argued, be properly incorporated in the original design of a building, "not merely applied, as is too often the case at present, to buildings already constructed or designed".(129) They called the attention of architects to this problem and discussed several patent inventions designed to secure adequate ventilation, many based on the idea of flues with apertures at the top of the room, warmed by adjacent chimney flues, so causing the vitiated air to be raised and extracted. The Professor of Architecture at King's College London, William Hosking, was one of the many ingenious inventors.

Yet having dwelt for considerable length on this topic, the Committee found themselves unable to recommend the enforcement of ventilation systems in the private dwellings of the poor.

"Even if capable of enforcement [it] must lead to an interference with the privacy of domestic life [and would be] most objectionable.. The application of proper principles must be the result of a more general acquaintance with the subject on the part of individuals".(130)

Here again, the fear of interference with the individual, even in the face of growing 'scientific' evidence, won the day. In the end, the recommendations of the Committee was limited to requiring ventilation for "all edifices for public assemblage and resort, especially those for the education of youth" (131). The same requirement was to appear later in the Towns Improvement Clauses Act of 1847 (see Chapter III page 137).

The most deplorable restriction to proper ventilation was the Window Tax.

"The legislature now says to the builder, plan your houses with as few openings as possible, let every house be ill-ventilated by shutting out the light and air, and as a reward for your ingenuity, you shall be subject to a less amount of taxation than your neighbour" (132).

The working of this iniquitous tax was presented to the Committee (133). The tax was 8s 3d per window, regardless of size. In many houses one large window was made to serve two rooms and privies rarely had any light or ventilation. Even a one foot square opening, without glass, cost 8s 3d. The Committee enquired about the effects of the 'relaxation' introduced by the Act of 1835 (134), under which all occupiers of houses, if duly assessed for tax in 1835, were then permitted to open

as many windows as they pleased without any additional charge. Naturally nearly everyone immediately put in more openings, but there was a trap awaiting them. The lawyers quibbled over the phrase "duly assessed", proved that nobody was "duly assessed" in 1835 - and the openings were at once stopped up again. "It was a breach of faith on the part of Government"(135). In certain medical quarters windows were seen as something of a danger, presumably because of the notion that cholera and other diseases were transmitted through the air:

"windows are not recommended as affording the best means of insuring ordinary ventilation, though they may be resorted to with advantage when the weather is not severe" (136).

Two architects in their evidence reflected a growing concern at the relationship between legislation and design and construction. Henry Austin remarked:

"I believe such legislation to be not only ineffective, but that much detailed improvements in building is consequently checked. I may instance the increased use of iron and slate that might advantageously take place, improved construction of flues and drains, and the judicious employment of superior cements. I consider that much discretionary power should be vested in proper official authorities in all matters of constructive detail. I have no doubt that many materials, particularly slate and iron, would be used more generally if it was not for the statutory restrictions" (137).

Professor William Hosking said "I should desire indeed to extend the provisions for liberating architecture from unnecessary restraint on the part of the legislature". Concerned at the problem of parapets for example, he added

"It would be both structurally, and as a matter of architectural disposition, an advantage that roofs should not only cover, but should oversail the external walls of buildings, to protect them from the weather, and for the sake of effect" (138).

This was 1843. The architectural profession was established, though still rather as an elitist club at the Institute of British Architects, yet its voice was beginning to be heard (139). The magazine 'The Builder' had just started, giving a weekly detailed record of the opinions from the building world. From this point on the interaction between building and legislation becomes much more evident.

Let us close this chapter as we started, with the voice of Southwood Smith. Here he is, giving evidence to the Royal Commission on 15 June 1843, still very much concerned with health, building and legislation and still carrying the banner, now somewhat tattered, for the

cause of the national building act.

"Whatever regulations are made for one part of the country should be made for all, as far as it may be found practicable to devise measures which can be carried out in all. I should rejoice to see the present prevalent system of separate local Acts abandoned. If there are certain regulations which are required for the whole country, and of this every fresh enquiry affords additional evidence, then such regulations should be made universal, and if local Acts are retained at all, their enactments should consist of regulations expressly adapted to each respective locality, in accordance with the great general regulations, and subservient to giving practical effect to them" (140).

\*\*\*

This first chapter has seen the establishment of the need for health controls in the context of buildings and it has also seen, at a remarkably early date, a proposal for building regulations to be applied on a national scale, a measure which would have extended these new controls right across the country. It came to nought however, not because its intentions were at fault, but because most of its ideas were too far ahead of public and political opinion and because it was based on the existing mechanism used in London, a mechanism which was not entirely suitable for these new demands. It was also hastily prepared and crudely formulated, open to attack on technical grounds and suffered from being caught in the political activities of the period. In addition there was apathy, self-interest, a fear of over control, of interference and uncertainty about the economic and social consequences. Yet this outburst of activity between 1840 and 1843, in such a short space of time, is very important because it represents the first steps, positively, in a new direction. There is now something of a humanitarian concern, but it is bedevilled by self interest rather than national interest. Beyond that there is a move towards more centralised control, a growing awareness in the public of a new attitude to the function of law, the beginning of a breakdown in some areas of privilege and tradition, a growth in expertise and the start of a reform in the attitudes and roles of the classes in society. Although all this does not materialise immediately in the form of statutes or regulations, it does have two important consequences. In the first place it accelerates a much needed reform of London's own regulations and precipitates those in Liverpool, which in turn will affect, as we shall see, the later national building by-laws. Secondly, the liberal ideals of the younger generation, with their Benthamite

inspirations, whilst they were now being held back by the older and more conservative generation will, as we shall also see, come into their own at the mid century, when this younger generation has reached the same position of power and control, and then many of the ideals of this early period can be realised.

The regulations proposed for constructional matters maintained the Georgian tradition. This is to be expected, since the traditional practice of building remained largely unchanged and indeed continued to remain unchanged until well into the 19th century. To what extent it was itself perpetuated by the very terminology of the legislation is debatable, but clearly it will have acted as a brake on certain innovations.

Within the regulations which were proposed in this period we should particularly the introduction of what may be termed the 'health controls' - space to allow the free movement of air in cellars, in the streets, in the spaces between buildings and in the rooms inside buildings. These were being grafted onto the existing mechanism of the older building acts, and this graft remains in all subsequent building regulation and reveals a fundamental flaw. This is because these 'health' regulations embody dimensions which are subjective - that is they can never be precise and are difficult to prove. With the constructional controls there is of course an immediate and empirical test. Impending collapse or the spread of fire can be readily observed and the need and nature of the regulation can be readily appreciated. With the 'health' controls this is not the case - no immediate outbreak of illness will result from a minor variation in the height of a room for example. There is no direct test and proof, and much of the subsequent history of building regulation is to be spent in searching and attempting to refine and prove these subjective and variable areas of control. They have come through in a number of examples in our present regulations. The geometric construction of a zone of open space outside a window is a crude mechanical device to achieve a very subjective control of the ventilation of a room, as is the control on the height of a room, unrelated to either area or cubic size. We can attribute these types of regulations to the period immediately after 1840. They were an obvious and convenient device at the time, but very artificial and simple in their technique.

Having now reached the end of the first of our three routes into this subject, it is time to turn and follow the second, namely the developments in London. These partly overlap in time the subject of this first chapter, but continue to take the account up to the middle of the century.

\*\*\*



NOTES TO CHAPTER I

- 1 G.M.Young, (Editor), 'Early Victorian England 1830-1865', Oxford, 1934: chapter III 'Town Life' by R.H.Mottram. p.201.
- 2 2 and 3 Will.IV cap.45.
- 3 4 and 5 Will.IV cap.76.
- 4 5 and 6 Will.IV cap.54.
- 5 L.Faucher, 'Etudes sur L'Angleterre', 1845. p.22. Quoted in J.H. Clapham, 'An Economic History of Modern Britain', Vol. I, 1820-1850 Cambridge, 1964. p.543.
- 6 M.Bruce, 'The Coming of the Welfare State', London, 1974, ed it. p.72.
- 7 G.M.Young, (Editor), 'Early Victorian England 1830-1865', Oxford, 1934: 'Portrait of an Age' p.449.
- 8 J. Snow, 'On the Mode of Communication of Cholera', 1849. (but according to R.A.Lewis, the theory was still fighting for acceptance as late as 1894, as the sceptical comments in Creighton, 'History of Epidemics in Britain' 1894, demonstrates. See R.A.Lewis, 'Edwin Chadwick and the Public Health Movement 1832-1854 : London, 1952, p.357.
- 9 H.Belinaye, 'The Sources of Health and Disease in the Community', 1832, quoted by B.Keith-Lucas, 'Some Influences affecting the Development of Sanitary Legislation in England', Economic History Review, Vol. 6, 1954, p.294.
- 10 Fifth Annual Report of the Poor Law Commission 1839. Appendix C No 2 : 'Report on the Prevalence of Fever in Twenty Metropolitan Unions or Parishes during the year ended 20 March 1838' by T. Southwood Smith M.D., Physician to The London Fever Hospital.
- 11 Select Committee Report on the Health of Towns 1840 P.P. 1840 Vol.XI p.277 (hereafter referred to as (Health of Towns 1840')).  
Evidence was given by (amongst others):-  
James White, District Surveyor for Marylebone.  
George Smith, District Surveyor for City of London South.  
Thomas Allison, Surveyor to the Fire Office.  
James Pennethorne, Surveyor to the Commission of Woods and Forests.  
William Duncan M.D., Physician to the Liverpool Infirmary.  
Thomas Cubitt, Builder.
- 12 Health of Towns 1840, p.xv.
- 13 6 and 7 Will.IV cap.86 and 7 Will.IV cap.22,
- 14 14 Geo.III cap.78.
- 15 Health of Towns 1840, para.2559.
- 16 Ibid. para.2573.
- 17 Ibid. para.1636.
- 18 Ibid. para.2831.
- 19 Ibid. recommendations, p.xv.
- 20 Ibid.
- 21 Ibid. evidence, para.2438.
- 22 5 Vic.cap.44. Liverpool had, however, already shown its concern over the state of the town by establishing a 'Select Committee of Improvement' towards the end of the eighteenth century. An Improvement Act was passed in 1786 (26 Geo III cap.12) and again in 1826, an Act (7 Geo.IV cap.27) promoted the planned extension of the town and the rebuilding of streets in accordance with a previously determined architectural design. (see W.Ashworth, page 56-57, and Sir J.A Picton, 'City of Liverpool, Municipal Archives and Records from 1700 to the passing of the Municipal Reform Act 1835', and J.Touzeau, 'The Rise and Progress of Liverpool from

- 1551-1835' p.586). But even so, Liverpool was hardly ready to meet the problems posed by the rapid influx of Irish in the 1840's.
- 23 The Times, 16 Feb 1841 p.4 col.d.
- 24 Health of Towns 1840 Evidence, para.2553. James White referred to a Mr Griffiths, the Police Magistrate of Marylebone, who had suggested that houses should not be nearer to each other than their height (in 1829).
- 25 Health of Towns 1840, Recommendations, p.xv.
- 26 Ibid. evidence, para.3427.
- 27 Ibid. recommendations, p.xv.
- 28 Ibid.
- 29 Ibid. ("So use your own property so as not to damage that of anyone else").
- 30 Ibid.
- 31 Ibid.
- 32 Ibid.
- 33 Ibid.
- 34 Ibid.
- 35 R.A.Lewis, op.cit. p.39.
- 36 H.Vol.55 17 June 1840 p.780.
- 37 5 Vic.cap.44
- 38 H.Vol.56 29 Jan 1841 p.138.
- 39 H.Vol.56 12 Feb 1841 p.536-540.
- 40 H.Vol.56 12 Feb 1841 p.543.
- 41 H.Vol.56 12 Feb 1841 p.551-2.
- 42 H.Vol.56 12 Feb 1841 p.553.
- 43 'Justice of the Peace', Vol V, No 10, 6 March 1841.
- 44 The Times, 16 Feb 1841 p.4 col.d.
- 45 H.Vol.57 1 Apr 1841 p.768.
- 46 H.Vol.57 2 April 1841 p.806 and 23 April 1841 p.1018.
- 47 H.Vol.57 4 May 1841 p.1447.
- 48 H.Vol.58 28 May 1841 p.892.
- 49 H.Vol.58 8 June 1841 p.1317.
- 50 H.Vol.58 18 June 1841 p.1568.
- 51 H.Vol.59 30 Aug 1841 p.474.
- 52 H.Vol.60 10 Feb 1842 p.236.
- 53 H.Vol.60 14 Feb 1842 p.316.
- 54 H.Vol.60 23 Feb 1842 p.902.
- 55 7 and 8 Vic.cap.84.
- 56 R.A.Lewis, op.cit. p.83.
- 57 Poor Law Commissioners' Report on the Inquiry into the Sanitary Condition of the Labouring Population of Great Britain, 1842.  
(Chadwick's Report)
- 58 Ibid. p.287.
- 59 Ibid. p.282.
- 60 Ibid. p.394.
- 61 Select Committee Report on the Regulation of Buildings and the Improvement of Boroughs 1842 P.P. 1842 Vol.X. (hereafter referred to as Report on the Regulation of Buildings 1842)  
Membership of Committee: Fox Maule; Wood; Manners Sutton; Craig; Beckett; Tufnell; Lord Ashley; Matthew Wood; Viscount Sandon; Brotherton; Hodgson; Hinde; Duncan; Hogg; Muntz; Col.Wood.  
Evidence was given by (amongst others):-  
Thomas Chawner, Commissioner of Woods and Forests.  
Joseph Franklin, Surveyor, Liverpool.  
Hugh Biers, Builder, and also on behalf of the Society of Master Carpenters.  
Robert Pilling, Manchester.

- Edwin Eddison , Town Clerk, Leeds.  
 William Lawrence , Builder, on behalf of the Corporation of London.  
 Richard Kelsey , District Surveyor, Surveyor to the Commissioners  
 of Sewers, City of London.  
 Thomas Hopkins , Manchester.  
 George Shorland , Manchester.  
 Ebenezer Robins , Surveyor, Birmingham .  
 John Kempson , Surveyor, Birmingham.  
 Scott , Surveyor of Works, Dundee.  
 James Leslie , Engineer to the Harbour Trustees, Dundee .
- 62 Report on the Regulation of Buildings 1842 , Evidence of Biers,  
 para. 622.
- 63 Ibid. evidence of Chawner, para.67.
- 64 3 Vic.cap.77 (1840).
- 65 Report on the Regulation of Buildings 1842 , evidence of Chawner,  
 para.42 .
- 66 6 Geo.IV cap.45 (1825).
- 67 Report on the Regulation of Building 1842 , evidence of Lawrence,  
 and Kelsey, para.1062.
- 68 Ibid. evidence of Chawner, para.68 (see also chapter II, page  
 and note 54).
- 69 3 and 4 Vic.cap.85 (1840).
- 70 Report on the Regulation of Buildings 1842 , evidence of Chawner  
 para.68.
- 71 Ibid. evidence of Biers , para.498.
- 72 Ibid. evidence of Franklin, para.277-8.
- 73 Report on the Regulation of Buildings 1842 , evidence of Pilling  
 and Hopkins, para.687 and 1346 .
- 74 Ibid. evidence of Shorland , para.1639.
- 75 Ibid. evidence of Shorland and Hopkins, para.1590-8.
- 76 Ibid. evidence of Lawrence and Kelsey, para.1035.
- 77 Ibid. evidence of Chawner, para.72-91.
- 78 Ibid. evidence of Biers , para.485.
- 79 Ibid. evidence of Biers, para.490.
- 80 Ibid. evidence of Lawrence and Kelsey, para.966.
- 81 10 and 11 Vic.cap.34.
- 82 S. and B. Webb, 'English Local Government Statutory Authorities  
 for Special Purposes', London, 1922. p.253.
- 83 Report on the Regulation of Buildings 1842 , evidence of Franklin,  
 para.392 .
- 84 Ibid. evidence of Biers, para.575.
- 85 C.C.Knowles and P.H.Pitt, 'The History of Building Regulation in  
 London 1189-1972 , 1972, p.31.
- 86 Report on the Regulation of Buildings 1842 , evidence of Robins,  
 para.1705.
- 87 Ibid. evidence of Franklin, para.399.
- 88 Ibid. evidence of Franklin, para.405.
- 89 Ibid. evidence of Robins, para.1710.
- 90 As in the Liverpool Building Act (Amendment) Act 1835. 5 and 6  
 Will.IV cap.54.
- 91 Report on the Regulation of Buildings 1842 , evidence of Scott ,  
 para.1192,
- 92 Ibid. evidence of Shorland , para.1619.
- 93 Ibid. evidence of Franklin, para.432 .
- 94 Ibid. evidence of Lawrence and Kelsey, para.1035.
- 95 Ibid. evidence of Chawner, para.133-4 .
- 96 Ibid. evidence of Lawrence, para.1023.
- 97 Ibid. evidence of Scott, para.1194.

- 98 Ibid. evidence of Kempson, para. 1841.
- 99 Ibid. evidence of Kempson, para. 1863.
- 100 In 1812, a 3'6" wide projection was added by Soane to his house at 13, Lincolns Inn Fields. The District Surveyor maintained that it infringed Section 49 of the London Building Act of 1774, but Soane's defence was that it was a portico similar to that at the Royal College of Surgeons, which had not caused any offence. Besides, it was, he maintained, his own freehold property and he had a right to project as he pleased, provided he did not interfere with the street. In spite of the District Surveyor's protestations, the Magistrate decided that house owners could lawfully build as far as the iron railings in front of their 'area'. Continual pressure from the Surveyor to get this decision reversed was unsuccessful : the case was allowed to drop and Soane's projecting facade was allowed to remain. See article by John Hebb, RIBA Journal August, 1896. p.539. Also A. Ainger, 'The Building Act with Notes and Cases' London, 1836.
- 101 Report on the Regulation of Buildings 1842 evidence of Biers, para. 592-616.
- 102 Ibid. evidence of Biers, para. 604.
- 103 Ibid. evidence of Kempson, para. 1861.
- 104 Ibid. evidence of Biers, para. 588.
- 105 Ibid. evidence of Shorland, para. 1603.
- 106 Ibid. evidence of Leslie, para. 1242.
- 107 Ibid. evidence of Kempson, para. 1855.
- 108 Ibid. evidence of Shorland, para. 1602.
- 109 Ibid. evidence of Kempson, para. 1819; Biers, para. 517; Eddison, para. 823.
- 110 Ibid. evidence of Franklin, para. 420.
- 111 Ibid. evidence of Franklin, para. 430.
- 112 Ibid. evidence of Shorland and Hopkins, para. 1576.
- 113 Ibid. evidence of Scott, para. 1182.
- 114 Ibid. evidence of Lawrence and Kelsey, para. 1025-6.
- 115 Ibid. evidence of Chawner, para. 156.
- 116 Ibid. evidence of Chawner and Franklin, para. 149.
- 117 Report on the Regulation of Buildings 1842, evidence of Kelsey, para. 1024.
- 118 Ibid. evidence of Biers, para. 580-6.
- 119 Ibid. evidence of Chawner, para. 150.
- 120 Ibid. evidence of Chawner, para. 154.
- 121 H. Vol. 66 14 Feb 1843 p. 575.
- 122 H. Vol. 66 29 Feb 1844 p.
- 123 Report of the Royal Commission Enquiry on the State of Large Towns and Populous Districts, (First Report 1844, Second Report 1845) (hereafter referred to as Report on State of Large Towns) Members of Commission: Buccleuch; Lincoln; R.A. Slaney; G. Graham; H.T. de la Beche; Lyon Playfair; D.B. Reid; R. Owen; W. Denison; J.R. Martin; J. Smith; R. Stephenson; W. Cubitt. Evidence was given by (amongst others):  
Henry Austin, Architect  
H. Biers, Builder  
James Braidwood, Superintendent of the London Fire Brigade  
E. Cresy, Architect  
T. Cubitt, Builder  
S. Foden, Architect  
W. Hosking, Professor of Architecture at King's College, London  
J. Savage, Architect  
J. Stevens, Architect and District Surveyor  
T. Southwood Smith M.D.

- 124 Report on State of Large Towns 1845, Recommendation No.23.
- 125 Ibid. recommendation no.23.
- 126 Ibid. recommendation nos.24 and 25.
- 127 Ibid. recommendation no.26.
- 128 Ibid. Second Report p.63.
- 129 Ibid.
- 130 Ibid.
- 131 Ibid. recommendation no.27.
- 132 Ibid. First Report, p.436.
- 133 Ibid. Second Report, evidence of W.Hickson, para.6172-3.
- 134 4 and 5 Will.IV cap.54.
- 135 Report on State of Large Towns Second Report 1845, Evidence of W.Hickson, para.6172-3.
- 136 Report on State of Large Towns Second Report 1845, Appendix ii, p.27 also J.L.and B.Hammond, 'The Age of the Chartists', London, 1930, p.96.
- 137 Report on State of Large Towns 1844-5, evidence, para.6049 (17 April 1844).
- 138 Ibid. evidence, para.432 (10 June 1843).
- 139 The full title of Royal Institute of British Architects was officially adopted from 1866 onwards.
- 140 Report on State of Large Towns 1844-5, evidence, para.988 (15 June 1843).
-

(Small Tenements Bill)

AUTHORS: Robert Slaney and Edward Tufnell

DATE: 17 July 1840

SOURCE: P.P. 1840 (508) p.657

References in text to page: 29

	SELECTED CLAUSES relating to building design and construction. Summary of contents	LINKS	
		ANTE	POST
1	<b>HABITABLE CELLARS</b> Houses not to be built below the level of the ground without areas or drains.	Health of Towns Report 1840	T2.c19 and c28
2	<b>STREETS</b> Houses not to be built in close alleys (i.e with closed ends). No dimensions given.		T2,c20
3	<b>SPACE ABOUT BUILDINGS FOR VENTILATION</b> Houses not to be built 'back-to-back'.		T2,c21
4	Rows of houses not to be built too close (no dimensions given), but not less than two thirds the height of the walls of the highest house in either of the rows opposite each other.		
6	Houses not to built unless the windows are constructed so as to allow them to be opened.		
5	<b>DRAINAGE</b> Houses without drains not to be occupied.		T2.c2
6	Houses without privies and ashpits not to be let.	T2.c27	

Notes 1) There were 11 clauses in all. Nos 7 and 8 concerned the appointment and fees for house wardens, no.9 the penalty for letting uncertified houses, no.10 the restriction of the Bill to houses with a yearly value under £30 and no.11 allowed the measure to be amended or repealed.

2) Controls on cellars had been attempted in London in the 17th century and also in the abortive Liverpool General Improvement Bill of 1802.

**BILL:** for THE BETTER DRAINAGE AND IMPROVEMENT OF BUILDINGS IN LARGE TOWNS AND CITIES

TABLE 2  
Sheet 1

**AUTHOR:** Lord Normanby (Henry Phipps, 1st Marquis of Normanby.)

**DATE:** 29 January 1841

**SOURCE:** 'Justice of the Peace' vol V. No.10

Reference in text to page: 30

	SELECTED CLAUSES relating to building design and construction Summary of contents	LINKS	
		ANTE	POST
19	<b>HABITABLE CELLARS</b> No room or cellar to be occupied unless there is an open area, 3'0" wide min. at the front and back of the room and extending from one party wall to the other.	T1.c1	T3.c13-c15
28	... and cellar to have a window and fireplace		
22	<b>STREETS</b> Carriageways = 25'0" min. Alleys and footways = 20'0" min.	new	T3.c18
20	Courts and alleys to have an open space at each end, 20'0" wide, and entirely open from the ground up.	T1.c2	
23	<b>STRUCTURE</b> Walls to be built on a bed of concrete, 12" deep by 18" wide, of lime and flint gravel or broken stone - or other construction approved by Surveyor as being suitable for 'shutting down the damp'.	new	T4.Sc.D
21	<b>SPACE ABOUT BUILDINGS FOR VENTILATION</b> To prevent 'back-to-back' houses, a minimum of 20'0" between back walls of houses - but additions and outbuildings allowed if not more than $\frac{1}{2}$ height of the walls of the houses, nor more than $\frac{2}{3}$ the width of the house.	T1.c3	T3.c17
24	Level of ground floor to be 18" above footway or road adjoining, with air-brick in front and back wall, 9" below level of floor.	new	T3.c20
25	No room in any house ... having only one room on ground floor, or having 4 rooms in all, to be less than 8'0" from floor to ceiling. In every such house, at least one room to be 12'0" clear, front to back, and 12' 0" side to side, excluding a closet or stair.  cont.....	Note*	T3.c21

26	Every room of 144 sq.ft. to have at least one window, 4'9" x 3'0" wide, clear of sash frame. Window either casement on hinges or double hung sash, opening at top and bottom.	T1.c6	T4.c5 T3.c23
27	No houses to be built without own enclosed back yard which, excluding any building thereon, shall be to extent of $\frac{1}{4}$ part min. of ground area covered by the house.	new	T3.c23
2	<b>DRAINAGE</b> Required the construction of drains for houses already built.	T1.c5+6	T3.c23
27	No house to be let without a 'necessary house' or privy, with proper doors and coverings, either in house or yard, screened from public view.		

Note\* London Act of 1667 required 8'6" in upper storey, 10'6" on main floor and 6'6" in the cellar.





32	Party and end walls, constructed as cl.30 above but no timber girders, beams, joists to be nearer than 9" to end of other timbers inserted in other side of party wall.	L'pool 1825 and London 1774	T4.ScD
33	All side, end and party walls to be carried above roof to form 12" high parapet.	London 1774 height = 18" Bristol 1788 height = 12" L'pool 1835 height = 24" Bristol 1840 height = 18"	
34	Chimneys: No flue to be nearer than 9" to face of party wall, nor nearer than 4½" to other flue. Back wall at chimney opening to be 8½" thick generally, and 13½" (1½ brick) in cellar.	London 1774 (dim = 4½")	T4.Sc.F
36	No timber in wall to be nearer than 9" to the inside of flue. No timber to support chimney opening.	London 1774 (dim = 8½") L'pool 1825 (dim = 9") L'pool 1835 (dim = 4½") Bristol 1788 (dim = 9")	T4.Sc.F
37	Arch over chimney opening to be of brick, stone or iron bar. Hearth slab to be 15" broad by 12" wider than length of chimney opening, on brick or stone trimmers at least 15" broad before chimney opening.	In all early acts in London, Bristol and Liverpool. (but London 1774 gave as 18" $\phi$ )	
38	Ovens and furnaces to have protecting walls, 9" thick.	L'pool 1839	
39	Height of chimney above roof = 6'0" max. unless held by iron stays. Min. side dimension of stack to be 22". (Not applied to buildings more than 18'0" from public way).	L'pool 1825 (dim = 4'0") L'pool 1835 allowed iron stays	
40	Inside and outside of every flue to be rendered or pargetted.	In all early acts in London, Bristol and Liverpool	
41	Lines of flues to be painted in 3" wide bands on buildings when they adjoin vacant land.	London 1774 L'pool 1835	T14.c64

42	<p><b>Roofs:</b> All flats, gutters, roofs, turrets, dormers, lantern lights etc, to be covered with incombustible material (except woodwork necessary for door and window frames).</p>	<p>L'pool 1835 L'pool 1839 London 1774</p>	<p>T4.Sc.G</p>
43	<p>Water not to drip onto streets, except from porticos etc. Pipes of lead, copper, tin or iron or brick or stone funnels to connect drains or channel stones to cisterns or reservoirs. (or may be below surface of ground).</p>	<p>In many early major acts e.g. London 1662 and many local acts elsewhere</p>	
44	<p><b>Projections:</b> No projections from houses onto public way, except as necessary for copings, cornices, facias, doors and window openings, open porticos, steps, iron pallisades, and shop windows. Shop stall boards: max projection = 10" in streets 30'0" wide or more and 5" in streets less than 30'0" wide. No cornices to shop windows to project more than 18" in streets 30'0" wide or more and 13" in streets less than 30'0" wide.</p>	<p>London 1774 Bristol 1788 but L'pool 1825 and L'pool 1839 were more stringent</p>	<p>T4.Sc.E</p>
47	<p>Cutting into party walls: 2½" or halfway. Width of chase not to be wider than 14" for bressummers, beam ends or storey posts, not deeper than 6" for insertion of iron or stone steps, or for stone corbels for chimneys.</p>	<p>London 1774 L'pool 1835 Bristol 1788</p>	<p>T4.Sc.D</p>
48	<p>Openings in party walls allowed only if iron doors and frames are fitted.</p>	<p>London 1774 L'pool 1825</p>	
17	<p><b>SPACE ABOUT BUILDINGS FOR VENTILATION</b> Houses not to be built back-to-back. All houses except corner houses, to have a clear space 20'0" wide between back wall and wall of opposite house. (excludes back additions and out-buildings not more than ½ height of back wall of house and not extending more than ⅔ width of house. No out-building to be nearer than 7'0" to other building, except privies and sheds not over 8'0" high.</p>	<p>T2.c21</p>	<p>T4.Sc.K</p>
19	<p>See under <b>STREETS</b> above.</p>		

20	Level of ground floor to be at least 6" above level of footway or roadway adjoining.	T2.c24	T4.ScC
21	Height of rooms in small houses: cellar, ground and upper floors, except upper storey in 3rd and 4th rate houses = 8'0" min. In upper storey or 3rd and 4th rate = 7'0" min.	T2.c25	T4.Sc.K
22	Only one storey allowed in roof.	new	
23	Third and fourth rate houses only, to have an enclosed yard, 1/6 <sup>th</sup> at least the area of the ground covered by the house.	T2.c27	T4.Sc.K
23	<b>DRAINAGE</b> Roof drainage - see clause 43, above. All houses to have a privy, with proper doors, screened from public view.	T2.c27	T4.Sc.H

NOTES:

- 1) Clause 26: "future buildings in Towns without local building acts to be built in accordance with this act".  
Clause 27: Exempted the subsequent clauses (i.e no 28 onwards) from operation in London, Liverpool and Bristol, where their own existing Acts would apply.
- 2) Amendments to this Bill were made as follows:
  - i 24 May 1841 (P.P. 1841 Vol I p125) increased number of clauses from 77 to 79 adding two related to Surveyor's fees.
  - ii 18 Feb 1842 (P.P. 1842 Vol I p 287) amended Bill to 78 clauses.
  - iii 27 May 1842 (P.P. 1842 Vol I p 351) as amended by Select Committee into Building Regulations of 1842. Reduced Bill to 35 clauses. Excluded clause 17 (back-to-back) clause 19 (close courts), clauses 26-28 (rules for additions), 30-62 (constructional requirements in existing legislation), clause 68 (fire in sheds), amongst others.
  - iv 27 June 1842 (P.P. 1842 Vol I p. 367) inclusion of new clause 36 which totally excluded Liverpool, which now had its own Act. (5 Vic.cap.xliv) of 18 June 1842.

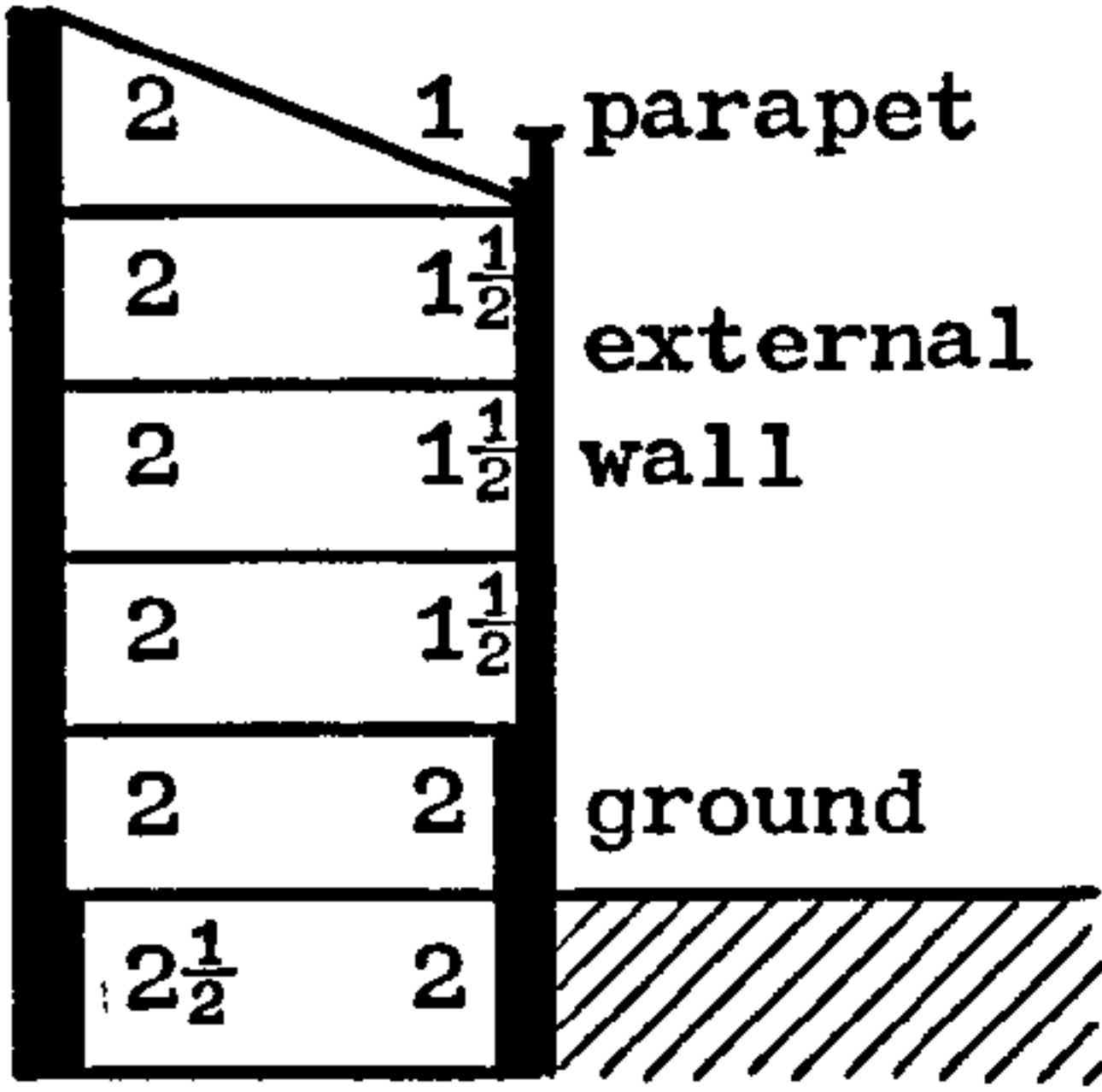
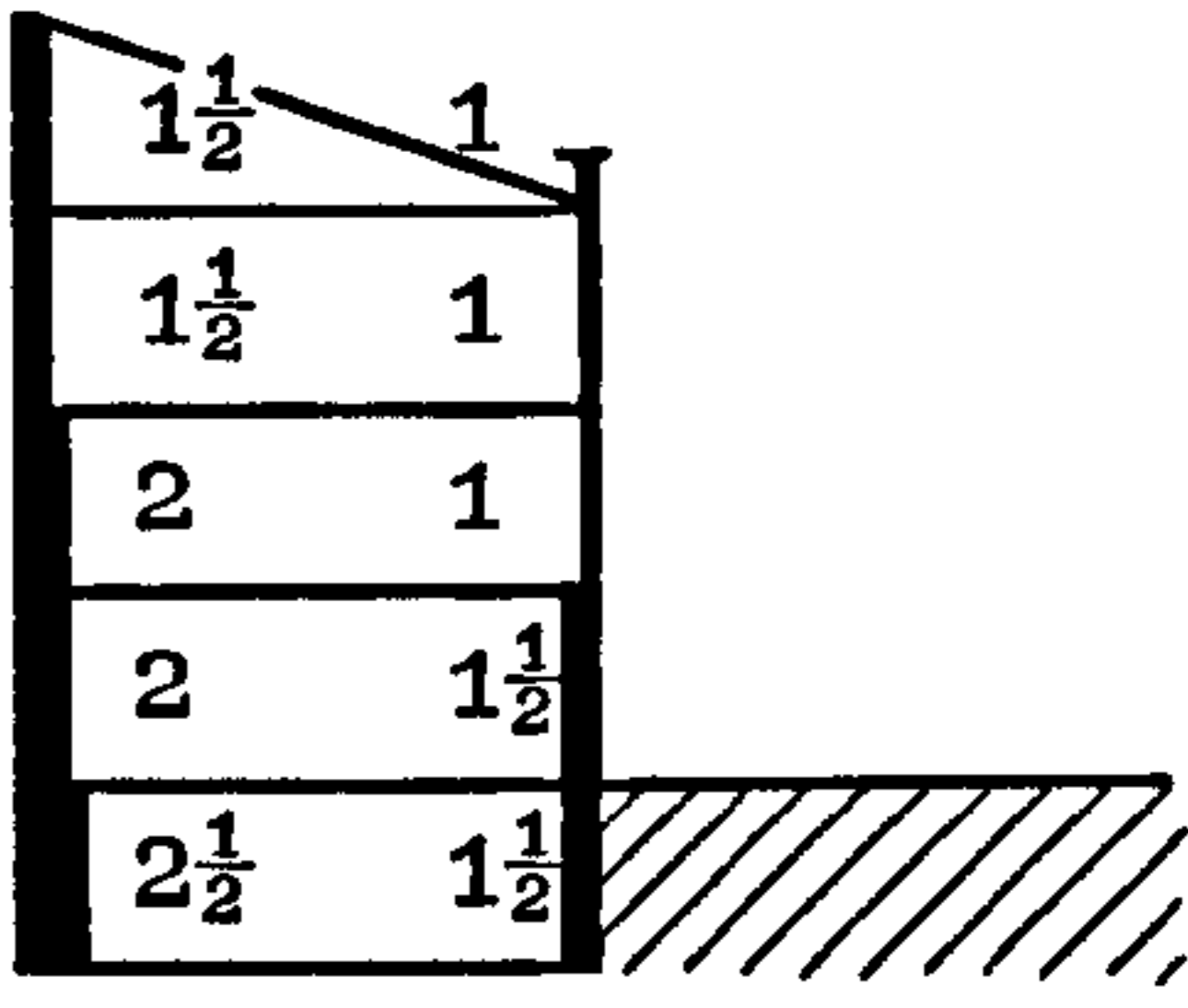
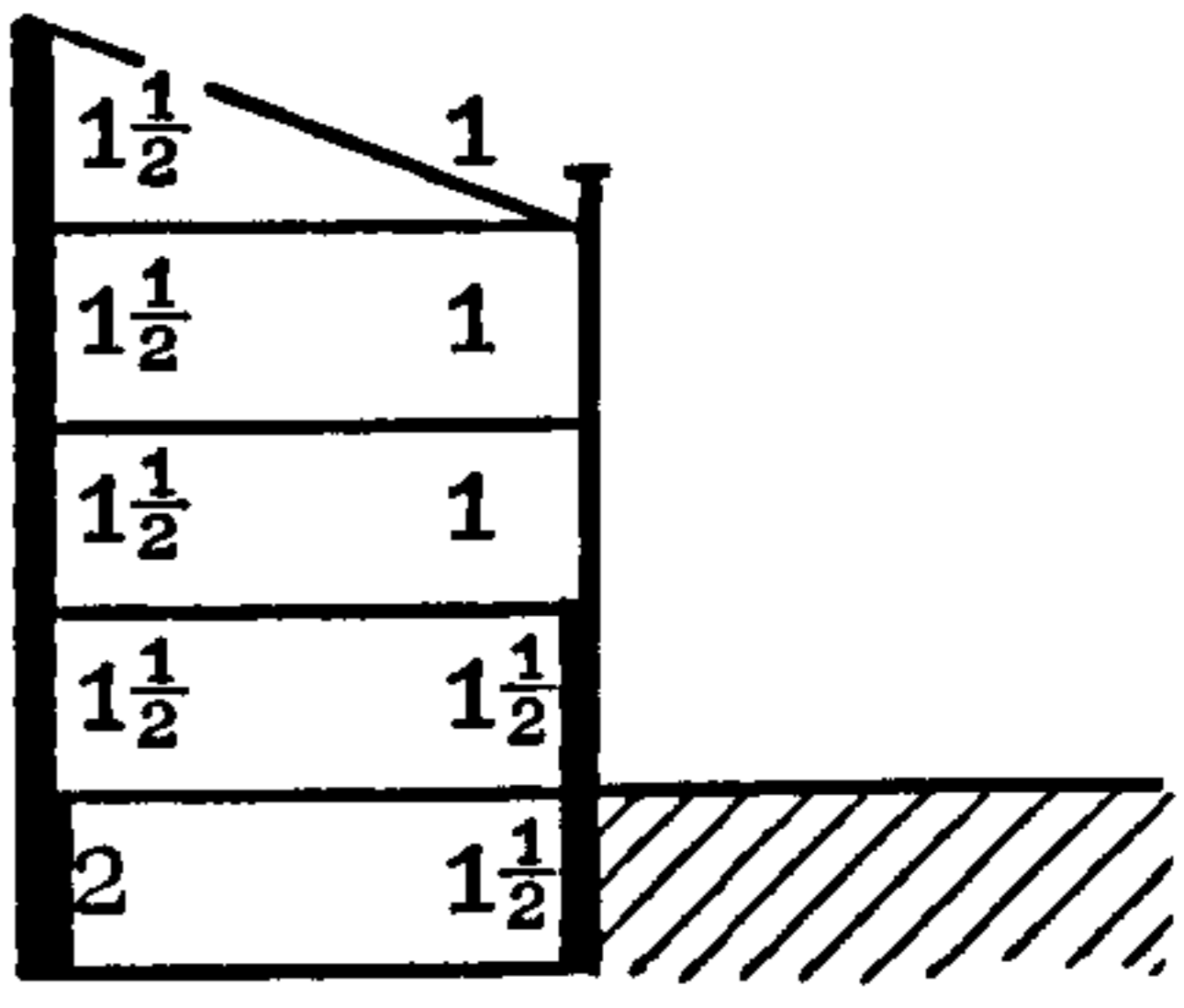
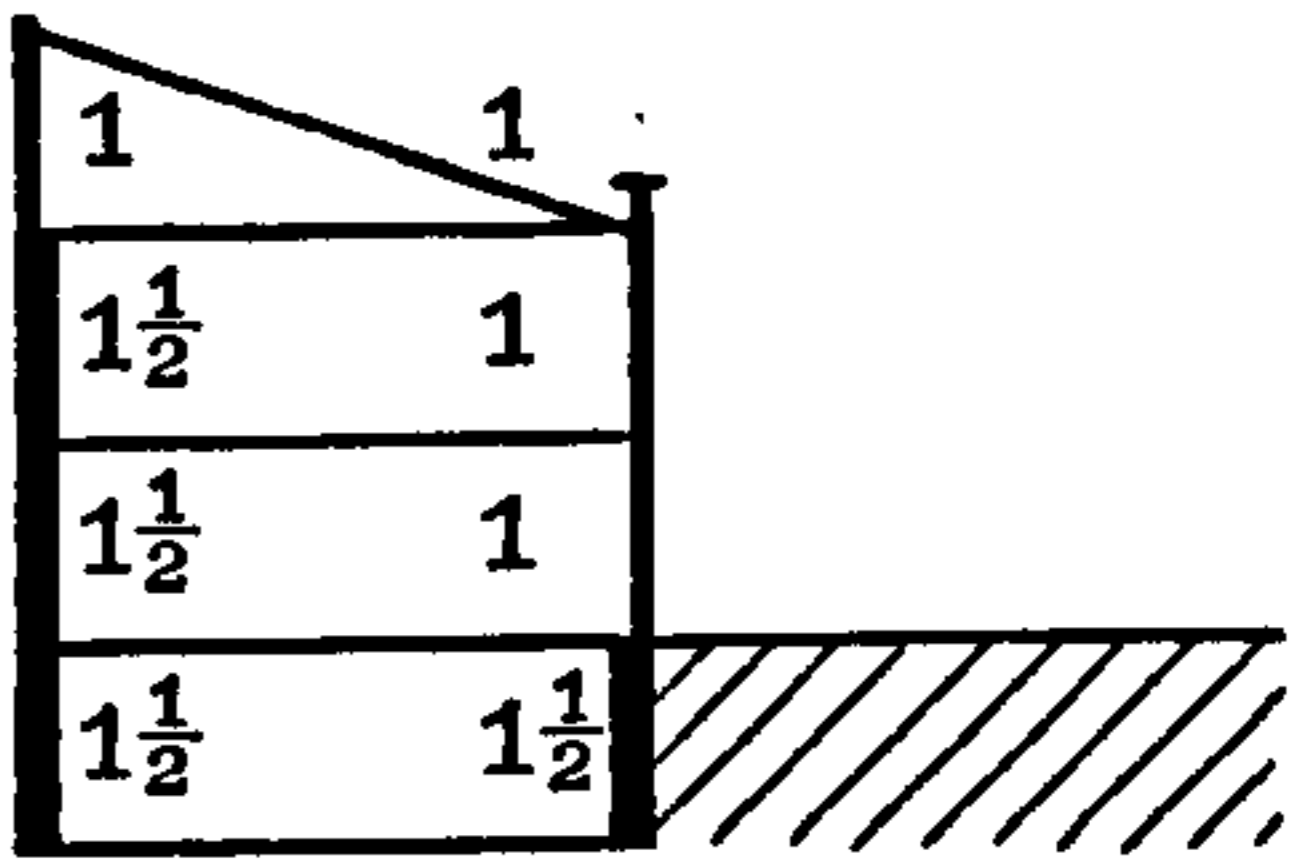
<p><b>FIRST CLASS</b></p> <p>Church, chapel, place of worship etc; Brewery, distillery, manufactory, etc; Warehouse or other building (not a house in class 5 or 6) which is higher than 31'0". Dwelling house which is higher than 50'0" or which contains more than 9 squares on the ground floor. Every dwelling house or other building which has more than three clear storeys above ground.</p>	<p>party wall</p>  <p>parapet</p> <p>external wall</p> <p>ground</p> <p>cellar</p>
<p><b>SECOND CLASS</b></p> <p>Warehouse or other building (not in classes 1, 5 or 6 nor a house) which is higher than 22'0" or which has three clear storeys above ground. Every dwelling house having three clear storeys and no more above ground and which is higher than 40'0". Every dwelling house which contains more than 5 and not more than 9 squares of building on ground floor.</p>	
<p><b>THIRD CLASS</b></p> <p>Warehouse or other building (not in classes 1, 2, 5 or 6 nor a house) which is higher than 13'0" and which has two clear storeys above ground. Every dwelling house having three clear storeys and no more above ground and which is higher than 37'0". Every dwelling house which contains more than 3 1/2 and not more than 5 squares of building on ground floor.</p>	
<p><b>FOURTH CLASS</b></p> <p>Warehouse or other building (not in classes 1, 5 or 6) which is higher than 13'0". Every dwelling house having 2 clear storeys and no more above ground and which is higher than 35'0". Every dwelling house which has not more than 1 clear storey above ground, or which does not contain more than 3 1/2 squares of building on ground floor.</p>	
<p><b>FIFTH CLASS</b></p> <p>Every building not in class 1 or a dwelling house, 4'0" min. and 10'0" max. from street and 16'0" min. from another building.</p>	<p>(Isolated building) NO RULES APPLY</p>

<p><b>SIXTH CLASS</b></p> <p>Every building not in class 1 which is 10'0" min. from a street and 30'0" from another building.</p>	<p>as above</p>
---	-----------------

## NOTES:

1. The numbers in the diagrams refer to the thickness of the wall in bricks, for example, 2 = 2 bricks thick (18" nominally).
2. A square = 100 square feet.
3. Footings : External and party walls : 4 courses min. Each two courses projecting  $2\frac{1}{4}$ " beyond wall above. Internal walls : 2 course min.  $4\frac{1}{2}$ " wider than wall above. (This is double the Liverpool 1835 and 1839 standards which required 2 courses to external and party walls and 1 course to internal walls).
4. The terminology used in this bill to determine the position for the changes in the wall thicknesses is the same as in the Liverpool Act of 1839.
5. This bill specifies that the side and end walls are to be 1 brick thick, but  $1\frac{1}{2}$  bricks thick if the wall is over 24'0" high. (Liverpool Act 1839 also specified side and end walls to be 1 brick thick, but  $1\frac{1}{2}$  bricks thick if over 24'0" high in churches and warehouses)
6. Liverpool Act 1839 included warehouses in the first class along with churches, chapels, manufactory etc.
7. Liverpool Act 1839 and Bristol Act 1840 regulated walls according to length as well as by height. The dimensions used in Liverpool and Bristol were similar to each other, but not the same as in this bill.
8. Dimensions for warehouses in this bill are the same as the London Act of 1774, as is also the regulation of the areas of houses according to the number of squares.
9. In Liverpool 1839 the Fifth class was for buildings not over 14'0" high, and not less than 3 yards from the street or other buildings. Bristol 1840 was similar, but at a distance of 10 yards from other buildings. There was no Sixth class in either Liverpool 1839 or Bristol 1840 Acts.
10. In general this bill of Lord Normanby can be compared to the Liverpool Acts of 1835 and 1839, Bristol 1840, London 1774. There are certain similarities between them as noted above, but direct comparison is difficult since each of the earlier acts used different systems for identifying the various classes. However, the wall thicknesses shown in this bill are the same as the London Act of 1774, except that the 1774 Act had party walls in the roof of the first class at  $1\frac{1}{2}$  bricks thick, external walls to ground floor of the third rate at 1 brick thick and the party walls of the ground and first floors of the fourth rate at 1 brick thick.  
Compared with the Liverpool Act 1839, Normanby's bill has a higher standard for party walls - generally  $\frac{1}{2}$  brick thicker, except that the wall in the roof of the Fourth class is the same as Liverpool, the wall of the cellar of the Second class is 1

cont.....

brick thicker, the first floor wall of the Second class is 1 brick thicker and in the First class houses the party wall to the first floor is  $\frac{1}{2}$  brick thicker and 1 brick thicker in the roof space.

11. Bristol had a separate schedule for stone walls.





## CHAPTER II

### THE METROPOLITAN BUILDING ACT 1840-1855

In this chapter we turn away from public health and the movement towards a national building measure to consider our second route, namely the parallel and important developments in building control in London. London is important here for the following reasons. First, it had a long established history of building regulation, a history going back to the Twelfth century, which has been well documented in the work of Knowles and Pitt (1). Secondly, it was in operation in the largest and most rapidly expanding city in the country and it therefore faced all the new problems generated by advances in building in a far greater concentration than elsewhere. Thirdly, being the seat of Government and fountainhead of legislative activity, its particular situation had inevitably a strong influence on the thinking of the drafters of the legislation, an influence which had determined the basic pattern of Normanby's Bills and which was to influence subsequently the later national measures when they appeared in the form of the Model By-laws.

The first half of the chapter outlines the formation of the Metropolitan Building Act of 1844, analyses its contents and surveys its progress up to the time of the introduction of a new Act in 1855. The second half considers the operation of this legislation in practice, tracing the factors which affected the conflicts which arose between legislative controls and the building world, factors which subsequently modified or extended the nature of the controls themselves.

With such attention to sanitary matters and the proposals for a new national Building Act, as we have seen in the first chapter, it is not surprising to find London itself considering the prospect of revising its still current yet by now out-dated Building Act, passed as long ago as 1774 and which, according to Lord Ellenborough, "possessed the only merit that no person could understand it" (2). Its shortcomings had been highlighted by the Select Committee enquiry of 1842. By 1843, a new bill had been prepared, in rather secretive circumstances, still broadly based on the pattern of the 1774 Act yet incorporating some of the innovations raised by Normanby's Bills.

The readers of the new journal 'The Builder' in 1843 were told of a "Bill being prepared secretly". The correspondent had learnt from private information "that the majority of clauses are exceedingly arbitrary and will cause great inconvenience and expense to all concerned with building" (3). The Editor of 'The Builder', architect John Hansom, pledged the attention of his new journal to this subject, noting that "legislation on matters affecting building interests, above all things, should be deliberate and not capricious"(4). Hansom's pledge was to be maintained and 'The Builder', particularly when edited by George Godwin after 1844, became one of the most faithful reporters of all matters relating to building regulation in the 19th century.

The Bill was read in Parliament for the first time in April 1843 (5). There was apparently still an expectation that some form of national building measure was imminent. 'The Builder' thought that "the new Bill would have a more influential bearing on the Provinces than its predecessors" and also that "it was drawn with more attention to the present state of building..... and must no doubt be regarded as a prelude to the introduction of a general measure, at least for the majority of large towns in the empire" (6). Yet all was not well with this Bill. It was conservative in its scope and did little to anticipate new developments in building. "We do not see a sufficient provision for meeting those exceptional cases that will undoubtedly occur in this age of improved structure" wrote Hansom (7). In some of his examples of this 'improved structure', Hansom showed an imaginative foresight. Querying the Bill's provision for all habitable rooms to have a fireplace and window, he wrote "will this always be the case? There are other modes of flueing the walls and carrying off the foul air, through walls for example". And again, he anticipated a frame construction in his reference to walls with "iron frameworks with concrete filling, or encaustic tile and brick facing"(8).

As the year went on, more and more objections were raised to the Bill. A gentleman signing himself "A Brickbat" bombarded 'The Builder' throughout June. An alley could be as wide as Watling Street : chimney breasts had to be of equal width throughout their height - 'what was wrong with corbeling?'; external walls 'should be thicker than 9" to stop the rain' and, contrary to the opinion of the Master Carpenters' Society 'sizes for timber scantlings should be specified' - as indeed

they were in Liverpool (9). The determination of a rate of a building by measuring the height of its walls only offered a premium on the formation of the 'curbed' or mansard roof, then considered to be unsightly, and the limitation of a shop height to 15'0" would, it was claimed, prevent the double height shop fronts like 'the two most attractive shops in London at the corner of the Quadrant and in Ludgate Hill' (10). Alfred Bartholomew, in succession to Hansom as Editor of 'The Builder,' advised caution and guarding against over legislation. To prevent fire spread in the lowest rate of house he felt a 9" wall was quite adequate - the Bill specified a 14" wall. That was no doubt reasonable, but his reluctance to accept timber size controls - "they will be vexatious, causing unnecessary interference by the District Surveyor and lead to extravagance" - and his fear of overcrowding and increased costs caused by the introduction of regulations for ventilation and drainage (11), whilst understandable in the context of the time, were unduly conservative.

Following its second reading in July 1843, the Bill went for revision by a small committee which included two gentlemen from the Institute of British Architects - "so it should be greatly modified and improved" (12). But unfortunately Parliamentary procedures and the lack of time before the end of the Session resulted in its failure to reach its third reading and it lay in abeyance until the following year.

Lord Lincoln, in introducing the revised Bill in February 1844, noted that it now excluded the provisions for fire which had featured in the 1774 Act, but confirmed that a new measure would be introduced shortly to cover that matter (13).

Similarly, drainage had also been excluded - except for the provision that no house should be erected without provision for proper drainage - since the matter was currently being examined by the Royal Commission into The State of Large Towns and Populous Districts. But widths of streets were now included, as were controls on buildings dealing with obnoxious trades and the prohibition of cellars for habitation except under certain conditions (14). In the Lords, Lord Normanby still maintained that the Bill should apply to the whole country - in fact he felt it was less applicable to London than to other towns. "A little effort on the part of the Government might make it applicable to other

parts" - but the Government, in its political wisdom, thought otherwise (15). The Duke of Buccleuch however, who was incidentally Chairman of the Royal Commission on the State of Large Towns, countered Normanby by saying that many towns now had their own local acts, but when the new London Act was passed and put into practice "it would be in the power of the municipalities in large towns to consider whether its enactments were applicable to their districts" (16). He did not wish to extend the Act because there was, he said, "the prospect of introducing a really effective measure next session". The idea of a national measure, or at least the idea of London setting a standard for the rest of the country to adopt, was still very much alive. Normanby continued to argue for the wider geographical extension of the regulations on cellar dwellings, but the Marquis of Salisbury, whilst admitting the evil of having persons huddled together, did not consider it practical, since 'the tenants would have to pay still higher rents for their abodes'. The extension of cellar controls had to wait until the Public Health Act of 1848.

Back in the building world, 'The Builder' generally welcomed the Bill as 'a measure as a whole which is calculated to effect much good' (17), although the Editor still retained a note of caution, particularly over the 'natural concern' people felt about the increasing extent of legislation and its possible infringement of their liberty. "A Brickbat" was now convinced of the Bill's superiority: "a very great step in advance of all late attempts" (18).

The revised Bill received its second reading in March (19), went through its report stage in May (20) and, in a debate in the Commons in July, Lord Lincoln proposed that it should go to a Committee (21). This debate again brought up the problem of possible further intrusion into the rights of the private individual, as well as the increased fees payable to the District Surveyors, the fear of interference with trade and the possible effect on the voting system. This latter point was a political concern since, as a Mr. Hawes explained,

buildings divided into separate tenements were rated separately and a vote allowed for each. Under the new Bill, only one vote would be allowed unless a separate entrance and stair were made and the tenement divided by a party wall. This was costly and would, he feared, extinguish a great number of valuable £10 votes (22). Mr.

Hawes was followed by Mr. MacKinnon (who had been on the Health of Towns Committee in 1840) who drew attention to three further areas which he felt needed more consideration. The first was the need to secure the abolition of the blind alley, "what the French call a cul-de-sac", in order to secure a free ventilation of air (a matter controlled in Acts elsewhere such as Liverpool); the second the prevention of back-to-back houses and the third the need for proper house drainage. These were all matters recommended by the Select Committee into the Health of Towns back in 1840. In reply, Lord Lincoln, who was also currently on the Royal Commission enquiry into The State of Large Towns, reminded first Mr. MacKinnon of the fact that Normanby's Bills had failed to survive the Select Committee enquiry of 1842, then said that he saw no harm in back-to-backs as 'he believed these buildings might be so contrived as not to be injurious to the health of the inhabitants', and finally stated that he did not propose any measures on drainage 'since a Committee was deliberating on that matter at that very moment'. Turning back to Mr. Hawes, Lincoln quickly dismissed any fears of interference with trade, private interests or the effects on the franchise system, and then successfully urged the acceptance of the Bill. It was duly read for the third time in July (23), passed its three readings in the Lords (24) and finally received the Royal Assent on 9 August 1844 (25).

At first the new Act was welcomed by the building interests, but the technical problems of its execution had yet to be experienced. It did not appear to stray too far from the confines of traditional building practice and was therefore seen as a relatively safe measure - initially at least. The Times, however, was more astute:

"The field it opens is wide indeed, interference is all but universal, and not a little injurious, while its remedy is partial and its execution by no means clear of difficulties" (26).

To the problems of its execution and its succession of proposed amendments we shall return shortly. At this point we turn to analyse the main contents of the Act itself.

\*\*\*

#### Analysis of the Metropolitan Building Act of 1844

The 'Act for regulating the construction and the Use of Buildings in

the Metropolis and its Neighbourhood' was an important and comprehensive measure, extending the geographical boundaries of control beyond those of the 1774 Act and repealing most of its regulations - although many of them were to be reframed in the new Act. Buildings were now grouped in three classes : the First for dwellings, the Second for warehouses, etc, and the Third for public buildings. The subdivision of the first two classes into the various rates is given in Table 4, sheets 10 and 11. Public buildings, in Class Three, were treated as a special case under control of the District Surveyors and the Official Referees. (The general establishment of the Surveyors and Referees is fully discussed in Knowles and Pitt's work - it is interesting to note here, however, that one of the two official Referees was Professor Hosking, whose opinions on building regulation matters have been referred to already). This section now concentrates on the technical aspects of the Act and, as in Chapter I, the contents of the Act are selected and arranged under the broad subject headings of cellars, streets, structure, ventilation and drainage.

Certain buildings were exempt from the controls of the Act (listed in Schedule B to the Act) and they included the major buildings such as the Royal Palaces, Mansion House, Bank of England and British Museum, as well as bridges, quays and gaols. More significant, however, was the exemption of certain buildings for the docks and railways, buildings covered by their own private Acts and buildings which, thus freed from building control, were able to experiment and develop new forms of building construction, the large iron frames for railway station shed roofs being but one example. This area of exemption is one which will be referred to again at a later point (see pages 163 and 218).

\*\*\*

#### Cellars (Table 4, sheet 1)

The cellar "area" was now allowed on either the front, back or external side of the building, whereas previously it had been restricted to the front only. This gave more flexibility in planning, but it was constrained by the new requirement for a certain area of open space to be immediately outside the cellar window. The acceptance now of an iron grating over the area was no doubt the result of the pressure to

maintain pedestrian access to shop windows on the ground floor, as suggested by the evidence to the Select Committee enquiry of 1842 (27). Similarly, the setting of the window size at 9 sq.ft. follows the evidence to the enquiry (28), although in the earlier stage of the Bill it had been set at 6 sq.ft., and the floor of the cellar to be 6" above the level of the area had also been discussed (29). In his evidence to the Royal Commission enquiry into the State of Large Towns and Populous Districts, Professor Hosking stated his conviction that cellars could be 'wholesome' dwellings (30) provided that they were above the drainage level and that they had a free circulation of air (31), the necessary fireplace and a flue (32). He further suggested a 6" space under the floor for ventilation (33), which would have implied a suspended timber floor - an expensive ideal, and one which did not appear in the Act. Hosking also made the interesting observation that under the old 1774 Act it has been the practice to ascertain the rate of the building - and thereby in consequence the thickness of its walls - by measuring its height from street level. It became a common device therefore to sink the building in effect and create a cellar room, thereby reducing the official height and consequently the rate, the wall thickness, and therefore the cost of the building. In the new Act the height was now to be measured from the surface of the lowest floor, not the adjacent street level (see Table 4, sheet 9), to one of three possible positions in the top storey or roof. This tended to limit the 'free' addition of a room in the curbed roof, a practice which the earlier proposal to measure to the top of the parapet only would have encouraged.

\*\*\*

#### Streets (Table 4, sheet 1)

Within the controls on streets, the important innovation was the establishment of a control which related the width of street to the height of the building, over certain minimum street widths. The 40'0" minimum dimension had been suggested by Cubitt (34) and in the first Bill the dimension had been subdivided into 24'0" for the actual carriageway, two footpaths of 5'0" width each and a further 6'0" to allow for the two 3'0" wide areas. The Act itself did not refer to these subdivisions. In Liverpool's Act of 1842, 24'0" only had been

allowed, giving 14'0" for the carriageway, 6'0" for two footpaths and 4'0" for the two 'areas'. Surprisingly, Hosking was satisfied with only 10 or 12 feet for the street width (35), but he stressed the need for a relationship to be established between the street width and the height of the houses (36), considering that the space in front of the house should at least equal the height of the house (37). In the Act, the width of alleys was reduced from Normanby's Bill, coming down to 20'0", and only one of the two entrances to an alley or court was now required to be 'open from the ground upwards'.

\*\*\*

#### Structure (Table 4, sheet 1)

The foundations to walls now received more attention, but no precise definition of 'other sufficient foundation', other than solid ground, was given. Footings in stepped brickwork or stonework followed traditional practice, although in its earlier stages the Bill had called for 'squared stone' both for footings and for walls. 'The Builder' thought this requirement unnecessary. "Those stone foundations (sic) which are of materials not squared but closely united at various angles, in general are the soundest and freest from settlement" (38). Bartholomew was also very much in sympathy with Pugin's insistence on 'opus incertum' for walls. Pugin, it will be recalled in his 'True Principles of Pointed or Christian Architecture' published in 1841, had sought to re-establish the mediaeval practice of small and irregular stonework as a universal principle. Not surprisingly therefore, Bartholomew objected to its omission from the Bill. "Opus incertum" masonry

"such as most ancient Gothic buildings are composed of, and which has in many thousand instances survived walls of squared materials. We advise an hour's two shilling ride to Cheshunt Church, which is of such masonry, sound and without fracture" (39)

The objections were successful - and the specific reference to squared stone was removed from the Act, as indeed were references to the quality of wall materials in terms of 'well burnt' brick or 'good sound' stone. A further objection was to the regular upward diminution of the footings under the wall on each side as called for by the Bill, 'The Builder' claiming that there were "many cases where walls need to be out of perpendicular, with their footings more on one side than on the other" (40).



The Act contained no specific mention of a damp proof course, although in Schedule D, Part I, there was a requirement for a minimum 6" between the ground floor level and the adjacent earth level. At the Royal Commission enquiry, which was proceeding at the same time that the London Act was being finalised, Thomas Cubitt had recommended a slate damp proof course, considering the alternative of asphalte as being too expensive. (41).

Professor Hosking proposed an alternative in the form of a gravel trench running alongside the wall, rather like a field drain. He considered that this would be more effective than asphalte, since it allowed the water to drain away (42). If this was not practical however, he was prepared to acknowledge that the use of slate, asphalte or a metal damp proof course might help "in some degree" (43). The cavity wall was not mentioned in the Act. We have noted a reference to it in Manchester as a means of countering damp penetration, but it was Hosking again which kept the idea alive, but this time from the point of better insulation. An inner lining of lath and plaster, separated by a cavity from the outer wall would, he felt, give better insulation "due to the body of air intervening" and he quoted the example of the traditional wainscotted room as evidence (44). "A half brick wall, battened, lathed and plastered would be more effective to withstand the variation in temperature than a 9" wall without.....and it would probably be cheaper" (45).

Table 4, sheets 10-11 show the schedule of wall thicknesses for the various rates of building and can be compared with those of Normanby's Bills in Table 3, sheet 5. It will be seen that no limit was now set on the height of walls, nor on the height of rebuilding walls to buildings in existing streets, which resulted in claustrophobic conditions in the old narrow streets. The Act also maintained the practice of inserting bond or chain timbers in walls, a practice deplored by Hosking (46). With poor bricks they no doubt helped to tie and strengthen a wall, but the effects of fire, decay and settlement were a constant hazard. Specifications for the bonding agents, lime, cement and sand, were also now omitted in the Act.

Parapets were maintained in the Act, but they were losing their popularity in certain quarters, more particularly in the camp of the

Gothic exponents. To Bartholomew they were

"ridiculous, tending to injure the formation of gutters properly, and affording no advantage. Nothing could be more absurd than to compel Gothic pierced parapets, carried up for ornaments, to be made expensively gouty : those roofs last far the longest which project without any parapets at all, the wet, in case of imperfection, falling without the building" (47).

Party wall parapets reverted from Normanby's standard to the 18" of the old 1774 Act, though 'The Builder' felt that from about two or three feet back from the public way they could be as low as 12" - that is, to Normanby's standard (48).

The rules for bressummers over openings in external walls were extended and became more complex than before. A rule of thumb method relating the height and span of beams was introduced, total reliance on a party wall for support was avoided, heights were more generous, not being limited to the ground floor only (allowing higher shop fronts thereby) and iron was now allowed, following Liverpool's example of 1835.

The restrictions on corbelling for chimneys, mentioned above in the objections to the first Bill, were maintained and still strongly opposed:

"The party walls being stronger as they advance towards the ground, and the chimneys growing lighter as they proceed upwardly, by the increase in the number of flues and chimney openings, the fears of want of sufficient support below are altogether unfounded : the constant finding of the finest buildings, several centuries old, unfractured and unflinching, although from their first erection they have had chimneys corbelled out, even externally from the face of the building, shows how needless would such prevention be" (49).

Similar objections were raised to the limitations on corner angle chimneys. Pargetting on the outside, called for by the Act, would be a disfigurement "giving secret licence to inferior work, because such work is to be concealed" (50). The angle of flues being changed to a minimum of  $135^{\circ}$  from the  $120^{\circ}$  in the Chimney Sweepers Act of 1840 (which was incorporated into this London Act) and the allowance of any angle if the flue was larger than 9" square, were both deplored - "by which soot may be collected in horizontal and flat flues and an addition to the execrable nuisance of soot doors be induced" (51). The setting of chimney pots into the top of the stack, which the Act stipulated as 2'0" min. penetration, was seen to be highly dangerous - "we lately had a case in which a zinc smoke funnel so fixed was blown

down in a storm, carrying with it, attached thereto, a lump of 4 cwt. brickwork.....escaping by only a few inches a man who was there at work" (52).

But all these regulations concerning fire and chimneys, the most controversial was to be the one controlling the distance of hot water or steam pipes from timber - but that only came to the fore in the course of the Act's operation, and we return to it in the latter part of this chapter.

The control of the pitch of warehouse and factory roofs to a maximum of 40° (it had been 50° in the first Bill) tended to prevent curbed roofs and their unofficial use for storage or hazardous processes, but there were no new controls on domestic roofs. Projections maintained their own elaborate set of constraints, the main point of contention being a ban on projections over public ways:

"The utterly forbidding of cornices and other decorations to private buildings to project over public ways would be fatal to architecture, and would have an effect of deterring, on that account, many persons from altering or rebuilding the fronts of their houses. It would be quite sufficient to forbid the dripping of water or other liquids from such projections upon any public way" (53).

In relation to party walls, Chawner's recommendation (54) that timbers be carried on iron shoes or corbels rather than penetrating the wall, was now incorporated, and houses were allowed to be united by openings through the party walls, although if the combined area exceeded 1400 sq.ft, the Official Referees sanction had to be obtained. Chases in party walls were still closely controlled, and there is a reference in the Act to metal pipes in chases, reflecting both the introduction of internal plumbing and heating pipes. Horizontal party floors, referred to as 'party arches' and party fence walls were also controlled, and maintained the same standard of controls as in the London Building Act of 1774.

\*\*\*

#### Ventilation Space about Buildings and Drainage (Table 4, sheet 7)

The new Act extended Normanby's proposal for backyards to lower rate houses only to cover now all houses, and established a minimum area of 100 sq.ft. for such a yard. There were obscure modifications to this rule, allowing a smaller area to suffice above the level of the

second storey - a rule which was to cause problems of interpretation once the Act was in operation. This variation was apparently introduced to meet the case where the site of a proposed backyard was already found to be occupied by buildings. Then "inasmuch as the light and air would not have to descend so low, an area of three quarters of a square (75 sq.ft.) to each house instead of back yards of one square (100 sq.ft.) each would suffice" (55). Hosking opposed these small enclosed yards, fearing that they would become "noisome from neglect" and preferred open courts both in front and behind the houses (56). This London rule generally prevented back-to-back houses, although a backyard was not required if all the rooms could be lit and ventilated from the street, but this was rare. Specific clauses banning back-to-backs had not survived the Select Committee enquiry of 1842, but it was raised again and discussed in the evidence to the Royal Commission enquiry into the State of Large Towns and Populous Districts. Three architects - Hosking, Savage and Austin - all felt that back-to-backs could be built without danger to health, and, of course, they were cheaper to build (57). The width of the court between opposite rows of back-to-backs was discussed. Hosking suggested 20'0" and also that the width be in proportion to the height of the houses - relationships which were incorporated in the Act and which confirmed the earlier discussions in 1841 and 1842 (58).

Room heights were set at a minimum of 7'0", a foot lower than those in Normanby's Bills, and additional rules were introduced for attics. The 3'6" restriction in the attic would, it was felt, "certainly operate detrimentally by occasioning the cubic contents of attics to be diminished by the lower parts being battened out with ashlar quarters to render them perpendicular" (59). There was no relationship between room height and room area in the Act. A minimum area of 100 sq.ft. had been considered in the first Bill, but it was later dropped (60), even though Liverpool still retained a minimum room size of 108 sq.ft. in its Act of 1842. The possibility of the control of the cubic size of a room for health purposes had been raised by the Royal Commission. The architect Henry Austin had agreed that such a control was necessary (61), but when questioned further about the specific amount of air needed for living or sleeping he answered that whilst it was very necessary for health, it was impossible to achieve (62). "As to their height, it appears to me a point that will not admit of

much abuse, but for the purpose of more perfect ventilation, it would be much more desirable to restrict the height (rather) than the area of the room" (63).

At an earlier stage in the Bill, an attic room height of 10'0" had been introduced. "Would it not be advantageous" the Royal Commission asked Austin "to say that they (attics) shall contain so many cubic feet, which would permit them to be in convenient forms for the building and not restrict them to be always exactly square or parallelograms". Austin agreed. "I think it would be better - there is no restriction I think with respect to the sloping of rooms in the roof, it is only required that there shall be the height of 7'0" at one point, but this clause is somewhat ambiguous" (64).

A final point on ventilation was raised by Hosking. He called for the need for underfloor ventilation to prevent dry rot occurring in floor timbers (65). He suggested a 'grating in the walls to allow a current of air to pass" (66), with an airbrick every 5 or 6 feet along the wall (67). He also considered that the floors of houses should be boarded (68) - in cellars as well, where, as noted earlier, he called for a 6" ventilation space underneath (69). But no such controls appeared in the Act - their introduction into building regulations was to happen much later (see page 284).

Drainage controls were extended somewhat beyond those of Normanby's Bill, but the infernal cesspool was still a feature with main sewerage still in its infancy. Hosking in his evidence to the Royal Commission had sought legislation to prevent any house being built without a proper sewer (70), but that was too premature. Water closets are now briefly referred to in the Act under drainage, but there was of course no compulsion to provide one. Thomas Cubitt, in his evidence to the same Commission, thought it was not yet time to provide a w.c. in every dwelling (71) but it was becoming more and more apparent that many were being installed - or rather added in rear extensions to houses. 'The Builder' reckoned that some 50,000 were being erected, without control, in the form of dangerous wooden erections (72). Hosking favoured the w.c., particularly if it was at the highest point in the building (presumably for ventilation) but he also mentioned the almost prohibitive costs involved (73). He suggested that each house should at least have its own privy (74) - an improvement over the Liverpool standard of one to every four houses.

The Act made a number of other important provisions in relation to fire. A building containing a particular fire hazard was to be at least 50'0" from another building, and 40'0" from a public way. Warehouses were limited in cubic contents to 200,000 cubic ft, without party walls. In First and Third Class buildings, fire proof access ways and stairs were required, the stairs being of stone or other incombustible material, as were also the passages connecting to the exterior. In Third Class or public buildings, the floors of halls, vestibules, corridors, stairs used by the public "must be wholly supported, constructed, formed and made and finished fireproof." Finally, it should be noted that the parts of the old 1774 Act concerning fire engines, ladder, firecocks, engine keepers and associated matters were retained and contained in force under the new Act.

This concludes the summary of the main contents of the Metropolitan Building Act of 1844, the most important set of building regulations to reach the Statute Books within this early period. Nearly all the controls discussed here are to reappear, albeit in modified form, in the subsequent Metropolitan Building Act of 1855, in the Form of By-laws of 1858 and in the Model By-laws of 1877. We now return to follow the course of the Act as it ran from 1845 to 1855.

\*\*\*

#### The Course of the Metropolitan Building Act Between 1844 and 1855

The new Act, before it came into force on 1st January 1845, was preceded by a spate of hasty and bad building, rushed up in an effort to avoid the imminent new restrictions. Lord Calthorpe's model dwellings at the Bagrigge Wells Estate for example, just avoided the new rules. His fifteen houses faced a narrow court, open at one end only and the yard to each house was described as being "literally what its name imports in feet, or very little more" (75). Elsewhere, the erection of shops on front gardens continued, built beyond the 'general line of fronts', avoiding the requirements of the Act and lowering the value of adjacent property (76). 'The Builder' considered, in the first month of its operation, that the Act was too stringent and it emphasized the danger of trying to act on it to the letter and thereby losing its spirit (77). With a fee and notice being required by the

District Surveyor for such simple matters as letting an iron air brick into a wall or a hole for a bellwire at a street door (78), these fears were justified. Two minor amendments were made in September and October 1845 by the Commissioners of Works and Buildings, one to allow privies and wash-houses to be built 'no longer at the rate to which they would have belonged if built separately' (79) and the other to modify the ruling on dividing walls in warehouses (80). By the end of the year, 'The Builder' was receiving a 'rush of correspondence' complaining about the new Act (81), the main area of concern being the strict administration imposed by the District Surveyors and Official Referees. Agitation for its amendment was rife early in 1846. 'The Times' gave its opinion

"The constitutional and very comfortable theory that every man's home is his castle has been virtually knocked on the head by this most annoying Act of Parliament" (82). And a week later - "it is seldom that a law becomes so rapidly and so universally unpopular as the new Metropolitan Building Act. Throughout the whole of its 120 clauses there really seems to be nothing worth preserving, and the only good which can possibly be made of it is to apply to itself a portion of its 18th clause, which provides for the abatement and abolition of anything declared to be a nuisance" (83).

The disproportionate amount of administrative interference over relatively trivial matters had quickly brought the whole Act into disrepute. As 'The Builder' said "The Metropolitan Building Act has been wrecked on pig styes, pigeon houses and chimney stops" (84). A petition from Kensington, an area previously outside the controls and notorious for its "jerry building," asked for a repeal of the whole Act (85), and a District Surveyor called for a return to the old system of judication by the police magistrates (86). The removal of Lord Lincoln from the Office of Commissioner of Works threatened a delay or even postponement of an amending bill (87), but under pressure and direction from Sir James Graham, an amending bill was introduced. But it was far from radical, certainly not meeting Mr. Hawes' demands in Parliament for a complete repeal and return to the old Act (88). All that this hastily prepared amendment succeeded in doing was to introduce a third Official Referee, it having been painfully obvious to all that disagreement between the two original referees simply resulted in a stalemate. The amending Bill was law by the end of March 1846 (89).

With only one minor amendment secured, pressure was naturally maintained for a more far reaching review of the Act. Under fire from Mr. Hawes in the Commons, Sir James Graham accepted that there were difficulties

with the Act and announced his intention of splitting the Act into four parts. The first two, to regulate buildings and control the Official Referees, would be introduced in June, the remaining two, to control property in relation to adjacent buildings and to control nuisances, "would take longer" (90). But no sign of the promised Bills appeared and the session of 1846 expired without result (91).

Faced with a renewed threat of Cholera in 1847, Parliament directed its attention towards the public health problem (see Chapter III page 141). But the curtailment of the Health Bill in May gave Lord Morpeth time to bring in an amendment to the London Act. He had intended a totally new measure, but time, he claimed, had prevented him from touching on only the more striking grievances (92). As a hasty stop-gap measure, it only succeeded in causing yet more confusion and complaint. It gave almost unlimited powers to the Official Referees, altered the wall regulations, banned wood plates in 9" brick walls (considered bad practice by 'The Builder'), introduced a new and controversial 16'0" rule in Schedule D - "an unjust and unnecessary interference with private rights" (93), restricted building over a public way, and required the continuation of all open areas at the back of houses down to the lowest floor. This latter was seen as being bad for tradesmen, depriving them of a valuable part of their property in the form of a rear ground floor room and resulting in the creation of a 'receptacle for filth' (94). The Bill was withdrawn.

In November 1847, Lord Morpeth established a private committee to reconsider the Act (95). The report was not published, but it was rumoured to contain a recommendation for an entirely new act (96), but no more was heard from that quarter. The Public Health Bill occupied Parliamentary attention in 1848, though in the face of another Cholera outbreak, this time in Southwark, two new Sewers Acts were passed, one for the City (97) and one for the rest of the Metropolis (98). The subject of the Building Act reappeared in 1849 when the Earl of Carlisle introduced a new bill in July. With its 150 clauses and 12 schedules, 'The Builder' wearily noted that "some of the clauses seem on a hasty inspection so singularly different from what we looked for" (99). In fact it contained some interesting new concepts. A supreme Registrar and Board of Appeal was a welcome proposal and in the constructional regulations a simplification of the wall thickness rule



was proposed. All buildings, except public, were to be of one class, the same wall thickness would apply to both external and party walls within each rate (except the upper two storeys of the 4th rate) and the wall thickness was to be determined by the number and height of the storeys (100). But yet again there was disagreement and prevarication, and the Bill floundered.

Lord Seymour saw no prospect of any new measure in the Session of 1850 (101), the areas of contention lay with the proposed Court of Building and the role of the Official Referees, rather than with the technical regulations. In January 1851 it was learnt that Lord Seymour now had plans for a new bill, and it duly appeared in February (102). Its future was still uncertain. "Cabinet making is going on in Downing Street, but there is difficulty in obtaining joiners, so that what work will be done is uncertain" (103). The new bill had only 45 clauses. The idea of the Registrar was abandoned : the Secretary of State was to appoint a Judge of the Court of the Metropolitan Building, who could be assisted by an 'architectural referee'. In constructional matters, the main changes were the enlargement of areas for First and Fourth rate houses, external and party walls to be the same thickness - except the party walls of the Third rate, which were to be 9" thick instead of 14" (104). No recognition was given to the imminent repeal of the Window Tax. A correspondent to 'The Builder' had suggested that the new Bill could have determined window sizes in relation to the size of rooms and allowed existing windows which did not let in enough light to be enlarged (105) - but to no avail. In general the measures in the new Bill were welcomed, although the role of the 'architectural referee' was viewed with some suspicion - in fact, throughout the Bill - "the abregation of the rights of the architectural profession is apparent" (106). The Institute of British Architects appeared on the scene, sent a deputation to Lord Seymour and, after a polite skirmish, retired to enlarge their Committee and to collect opinions from their colleagues (107). Although Seymour's Bill was withdrawn in May 1851, the Institute of British Architects still met on June 19 to discuss the Bill. It managed to assemble a grand total of 20 members, hardly representative, yet it focussed its discussion on the proposed Court and parallel administrative matters, and concluded by generally approving the Bill.

A new bill, very similar to its predecessor, appeared in July 1851. The Court of Building was now to be presided over by a 'barrister of not less than seven years standing' - whose knowledge of building matters was not, naturally enough, specified! (108). The areas and nomenclature for the various rates of building was again altered - the lowest rate reverting to the old standard of 400 sq.ft. - a retrograde step "which had led to the erection of thousands of habitations woefully insufficient for the comfort and health of the inhabitants" (109). A new development concerned wall thicknesses. Besides the external and party walls being the same, their thickness was now to be determined by the total height of the wall, not the number of storeys as before. There was a new clause requiring all building to be made or kept safe and secure, both for the 'inmates and persons outside', a clause which it was felt "would lead to much annoying and unnecessary interference" (110). Once again, debate and delays resulted in the abandonment of the Bill.

The following year, 1852, Lord John Manvers introduced a new bill which simply reverted to all the clauses of the existing 1844 Act, only introducing a new form of Court and an 'architectural referee, in case he should be needed' (111). Within a week, the Bill had sunk. "We must strenuously protest against this uselessly occupying the public attention and wasting the public money" thundered 'The Builder' (112). The solution to the problem of obtaining a new Building Act for London seemed as remote as ever. Parliamentary obstructionism and the warring between rival interests were rampant. Yet as one correspondent pointed out:

"The building interest has two active representatives in the House of Commons - Alderman Cubit and Mr. Peto. They would add to their laurels.....if they would apply themselves to the question of a practical and simple Building Act" (113).

As an example of the pathetic state to which Parliament's awareness had sunk by this time, we have the extraordinary example of the Bill introduced by Viscount Hutchinson later the same year. The sole purpose of this expensive, futile and time-wasting Bill was to legislate for the introduction of Mr. Donald Grant's Patent Ventilating Apparatus. In fact it only reached its second reading in the Lords, being properly rejected on the grounds that it merely authorized a private invention (114). Only once before had a private invention, that of 'John's Patent Tessera' received the approval of Parliament, but that had

reached the Statute Books back in 1810.

"When is the Metropolitan Building Act to be amended?" was the desperate plea of 'A Quiet Observer' in October 1853 (115). The existing Act was wearing thin. At the Architectural Association, Mr Inman referred to it as one of the greatest obstacles the architect now had to contend with, although "endeavours were being made to harmonize its requirements to the necessities of the day" (116). In March the following year, Sir William Molesworth announced that the Board of Health were again considering an amending bill (117), but in May Lord Palmerston reported that "the difficulties in the way were so very great that he very much doubted whether there would be any possibility of introducing it that session" (118).

Matters came to a head in 1855. Parallel to the new Public Health Bill being prepared by Sir Benjamin Hall, a new Metropolitan Local Management Act was proposed, into which the areas of streets and cellars were to be diverted from the Building Act. Sir William Molesworth brought in his new Building Bill for London in April although, as a sign of the confused state of parliamentary business, on the day before he brought it in, Lord Palmerston claimed to have no knowledge of when such a bill would be introduced (119). The new Bill contained 120 clauses within its 46 pages. The reaction was vehement. "Some of the clauses seem to us to be positive nonsense - how much has it cost the country - it is obscure and insufficient, if not wholly impractical" said 'The Builder' (120). The rules for calculating wall thicknesses, for example, were positively bizarre (these are elaborated further in the following section). A parliamentary committee was set up to enquire into the Bill (121). Fortunately, it decided to simplify the wall thickness rules, condensing them into one straightforward schedule. The Committee sat throughout May, hearing evidence from many authorities, including Gwilt and Tite from the architectural profession and Braidwood from the Metropolitan Fire Brigade. The Institute of British Architects again assembled to discuss the Bill in June, spending considerable time on Hesketh's theories of wall thickness regulations, yet concluding that there was really very little wrong with the existing Act. Charles Barry, Papworth and Tite all supported a motion to this effect, which was duly passed (122).

By June the amended Bill was seen in a more favourable light, yet there were still areas of doubt. For example, the requirement for eaves and cornices to be of brick, stone, slate, tile or other fireproof material would, it was felt "put an obstacle in the most natural and proper way of roofing" (123), and at one stage in the Bill's progress it was rumoured that a 'leading architect and builder' had proposed that there should be no projections facing onto streets, even over the owners own ground, except for small porches (124). Fortunately for the sake of "street architecture", the Lords rejected this amendment and reverted to the existing rules requiring incombustible materials for overhanging roof eaves. The 100 sq.ft. of open spaces was now required to belong exclusively to each house, a rule which many still felt to be too stringent, the complete coverage of the ground floor for a shop could, it was argued, hardly injure the owners health. The removal of wall thickness rules for public buildings, leaving this and other aspects of public building to the discretion of the District Surveyor was also viewed with considerable suspicion (125). Nevertheless, the Act to amend the laws relating to the construction of Buildings in the Metropolis and its neighbourhood was duly passed on 14 August 1855, coming into force on the 1st January 1856 (126). In the last week of 1855 'The Builder' wrote "The new Metropolitan Building Act will, we fear, raise many questions" (127). These questions and the details of the new Act, we shall discuss in Chapter IV. This section has shown how the pressures for amendment developed over the years, attempting to adjust the controls to meet new standards of the period, yet thwarted by Parliamentary mismanagement. The remaining part of this chapter now looks at the operation of the legislation in practice in the real world of building, giving further evidence of the changes which new standards and advances in building brought to bear on the legislation.

\*\*\*

#### The Metropolitan Building Act in Practice 1845-1855

The section is divided into three parts, relating to the operation of the regulations from the point of view of the three main forces which are the basis of the controls, namely : fire, structural stability and health.

## Fire

"The constant recurrence of destructive fire will one day lead to an entire alteration in our manner of building" said 'The Builder' in 1846 (128). The most obvious cause was the excessive use of timber, the root cause, in Professor Hosking's view, of fire-spread through timber partitions, hollow floors and stairs. He advocated a greater use of brick for internal walls instead of timber, giving an additional benefit of added strength, and drew attention to the systems employed by the French who used oak quartering partition filled with rubble and covered with plaster of Paris as well as various novel systems of fire proof flooring constructions, many of which employed a solid mortar packing between the joists, a similar technique apparently being used in the Charnwood Forest area of Nottingham where 'the houses are said never to be burnt' (129). 'Aliquis' writing in 1848 reiterated the need for regulations to be introduced to prevent open timber in floors, ceilings and partitions (130), and J.C. Loudon, in his 'Encyclopaedia of Cottages and Villa Architecture' had made similar demands (131). The call for legislative attention ran right through the period. Even in 1855, an article in the 'Quarterly Review' complained about hollow timber floors and partitions -

"a method which has the effect of circulating the fire from the bottom to the top of the house in the quickest possible space of time. As we understand that the Building Act is to be amended this session, we trust Sir William Molesworth will extend the clauses relating to party walls to rooms as well as to houses" (132).

But the call for attention to this area remained unheeded by the legislature, the economic and practical consequences for the building trade successfully resisting such stringent measures.

Cast iron, used for some time in the early mills and warehouses, also came under attack. Although allowed by the acts, it was patently unsafe in the case of fire. "Bearing beams and girders of cast iron, in bresssummers and storey posts, are liable to break when dashed with water in a fire or to soften and fuse" (133). Braidwood, of the Metropolitan Fire Brigade, addressed the Institute of Civil Engineers in March 1849 on the effects of cast iron in a fire. He recommended that the whole of warehouse building be of incombustible material, with external openings kept closed, isolated stairs to every storey, water pipes connected to a street main, iron beams and columns together with brick arches designed to resist not only dead load, but

also impact forces, and a current of air within hollow iron columns to prevent them melting (134). Many warehouses managed to evade the Act - Cook's warehouse near St. Paul's for example was reported to contain over a million cubic feet, undivided by party walls, The Manchester warehousemen evaded the Act, claiming that their buildings were for 'breaking bulk' for trade and not simply storage warehouses. "It was like taking 25 dwelling houses and removing the party walls" (135). Undivided roof spaces ran over Somerset House and over the 'Doctor's Commons', where wills were stored. Even Cubitt's famous so-called fireproof works at Pimlico had succumbed to the flames - "the latest proof of the entire fallacy of supposing stone and iron can withstand the action of a large body of fierce flame" (136). Two buildings met with Braidwood's approval. One was the new Record Office in Fetter Lane, designed by Sir James Pennethorne and built of iron and stone, but with room sizes limited to 17'0" x 25'0" and with vaulted corridors and iron doors (137). The other was a new block of 'flats' in Victoria Street, Westminster, which had vaulted floors filled with concrete on the French system described earlier (138). Liverpool had taken more advanced legislative measures than London in 1843, amending its Act following a great fire in Formby Street in 1841. Party walls ran up 5'0" above the warehouse roofs, the cubic contents were strictly limited and doors and penthouses had to be of iron (139). But London, with increased building sizes, did not match the Liverpool standard.

"London is growing upwards to the sky - no house in any valuable portion of the Metropolis being now rebuilt without the addition of at least one storey. 80 to 90 feet is getting a common height for our great offices and warehouses" (140).

The Building Act, it will be recalled, set no upper limit to wall heights, and such buildings were beyond the reach of the Fire Brigade, thwarted also by a lack of mains water pressure and a constant supply - even though Braidwood was anticipating steam assistance for his engines.

The use of timber for stairs was considered more dangerous than stone, although the friable nature of stone under heat and in contact with water was not fully understood, and it was specifically opposed until 1865. The London Act reinforced this attitude to stone, allowing it for fireproof stairs, landings and passages in First and Third Class buildings. An alternative was the use of other routes of escape, for

example, over the roofs of adjoining properties (141) but not everyone was convinced of this:

"The legislation.....instead of enacting that builders shall provide for the escapade of obese citizens and dowagers, unused to gymnastics over the tiles (I speak felinely) .....would strike at the tap root of the evil and prohibit the use of wooden stairs" (142).

This correspondent then advocated the free standing Scottish 'turnpike stair', connected to the building only by landings at each floor level - an idea which was to recur from time to time. A succession of dramatic theatre fires - the Theatre Royal in Quebec in 1846 (143), the Theatre Royal in Glasgow in 1849 (144) and the Victoria Theatre in London the same year (145), all served to emphasize the need for fire precautions in Third Class or public buildings.

Asphalte for roof coverings was a further material to cause problems with the Act from the point of view of fire. Claridge's asphalt on a flat timber roof at a house in the Fulham Road was not allowed by the District Surveyors in 1845 (146), yet a month later, the official view had been reconsidered and Asphalte of Seyssel was considered acceptable, provided the roof structure itself was wholly composed of incombustible matter (147). But the use of this material remained in a state of uncertainty, and it was to be questioned again in a later period (see page 190).

As mentioned in the previous section, the most controversial matter was the clause setting hot water, air or steam pipes a minimum of 14" away from any timber. The public baths in George St, Euston Square were an early example of an infringement of this clause. Despite the nature of the building, the position of the pipes had to be adjusted to conform (148). Collards, the piano manufacturers in Tottenham Court Road 'inadvertently' infringed the Act, but they claimed that they could control the temperature of the steam in the pipes and that it was essential for cabinet making (149). Opinions varied on the severity of this clause. One writer considered that whilst hot air in pipes had to be controlled by regulation, he added that:

"such a rule need not be applied with respect to air which is only to be gently warmed, say, by warm water or steam and the prohibition of pipes conveying steam or hot water near woodwork is a useless and vexatious interference, except indeed with regard to pipes in which water heated under pressure is to be conveyed, such rules.....throw great obstacles in the way of improved modes of warming and ventilating buildings, and thus retard sanitary advancement" (150).

But Braidwood, in his evidence to a House of Lords Committee in 1846 had felt otherwise. He believed that after long exposure to heat, "timber is brought into such a condition that it will fire without the application of a light", possibly taking as much as ten years before ending in spontaneous combustion (151). Professor Hosking supported Braidwood's view, quoting the example of Day and Martin's Blacking Manufactory in High Holborn which had caught fire in 1848 apparently from just such a cause. The 'Quarterly Review' cited the fire at the Mercer's Hall in 1853 and added "it is commonly imagined that the introduction of hot water, hot air and steam pipes, as a means of heating buildings, cuts off one avenue of danger from fire. This is an error" (152). As we shall see in our analysis of the 1855 London Act (page 127), these rules were to be altered in the light of this type of evidence, and rules based on these London standards were to come through in the Form of By-laws of 1858.

Outside the building, the problem of fire served to highlight three areas of controversial regulation - the space between isolated buildings, eaves and projections, and the projection of party walls above the roof.

The regulation controlling the space between building is shown on Table 4, sheet 9. The 30'0" dimension caused great concern, since the pressure to build houses close together, with the cheapest and traditional timber eaves - the most 'natural way', was very strong. Houses in Canonbury Park, 30'0" apart but only 15'0" from the ground of the adjoining owner was a test case in 1846. The Official Referees granted a waiver, allowing timber eaves provided it could be guaranteed that the 30'0" distance remained permanently clear of building (153). Hosking, in his work (Hosking 1848) had recommended that the distance between houses should be the same as their height. If it was to be less, then he suggested that windows should be arranged so as not to be opposite each other. This may have influenced the formation of the 16'0" rule mentioned in the preceding section and shown in the diagram (Table 4, sheet 12). Again, this was an area of regulation which was to be revised in 1855 Metropolitan Building Act (see page 219) and it was to come through in the subsequent Model By-laws.

The problem with the eaves was one of suitable materials. The Act



required them to be of the same material as the walls. Four houses in Norfolk Road, Marylebone, therefore had to have their wooden eaves with plaster soffits replaced by iron laths and plaster in 1847 (154). Houses built by Charles Delay in Kensington had the ends of the rafters covered with zinc - but zinc was not in the schedule of wall materials. George Godwin, Editor of 'The Builder', pointed out that the eaves were really part of the roof, and zinc was acceptable as a roofing material under the Act. Yet the Official Referees refused to accept this (155). A year later however, villas on the Mount Eliot Estate in Blackheath came before the Official Referees, since they had lath and cement for the eaves. The Referees view was now expressed as follows: "we understand from very high authority that a wooden cornice or soffit to a roof, not overhanging over the public way, is not contrary to the Act". To the astonished District Surveyors protests the Referees retorted "Well, we understand not - do not bring any more such cases before us". The decision vindicated Godwin's earlier interpretation of Mr. Delay's case. It was now accepted that the eaves were part of the roof and not part of the wall (156). The diagram on Table 4, sheet 13 shows the change of architectural interpretation of this condition. The following Building Act of 1855 listed the suitable materials for the eaves or cornice to any overhanging roof, removing the reference to the same materials as the wall.

Finally, the projecting party walls above the level of the roof. This was traditional in London, but its effectiveness was often questioned as a fire precaution. It was a difficult detail to build satisfactorily, demanding skill in proper flashings to prevent damp penetration. Its use was not confined to London - it occurred in Bristol and we read of two other provincial towns where its use was proposed. In Northampton, the local builders petitioned the Improvement Commissioners in 1853, claiming the 15" projection above the roof to be objectionable on the grounds that 'the wet got in'. 'The Builder', edited as it was by Godwin, a London District Surveyor, said the builders should attend to "effecting it in a sound and efficient manner" (157). Similarly, the builders in Rugby petitioned their Local Board in 1854, claiming that taking the party wall to the underside of the slates was just as effective and much cheaper. Again 'The Builder' was aghast, considering that there 'must be some mistake in this report' (158). The regulation remained in London - and duly appeared in the first Form of

By-laws in 1858.

\*\*\*

### Constructional Stability

In spite of the elaborate range of controls over wall thicknesses within the Act, it did little to prevent the continuation of 'jerry-building' - "perhaps the greatest evil of the Industrial Revolution" (159)

"That previous Building Acts for the Metropolis ... have failed to ensure sounder construction than is found in places where there are no legislative enactments on the subject, is certain" (160).

The provision of the Act were, it is reported,

"constantly and perse veringly disregarded by some builders. The more respectable builders on speculation have as strong an objection as any to these proceedings, and to scarping work ... and urge that they themselves are forced in self defence to build less well than they would desire, or they would be driven out of the market" (161).

Reports told of lack of bond in brickwork, 'arches' over windows made of straight bricks placed at angles with a rough off-cut jammed in as a keystone, no control over timber sizes and appalling bad mortar - "out of the solid part of a chimney breast, into which we had occasion to cut the other day, six barrow loads of dry rubbish ran out like sand" (162). None of these matters were controlled by the Act. Roof

construction perpetuated the cheap but unstable 'V' roof, its central valley gutter running down the centre of the house, supported, if at all, on a timber partition only. Of the "notorious abomination, the 'V' roof", 'The Builder' wrote : "the ruin which the groaning instability of place bricks and the failure of breastsummers, false arches and quartered partitions has begun, this completes" (163). The Act included roof covering materials - but its supporting construction remained outside its control. Accidents and collapses abounded.

Cast-iron columns, overloaded by enormous weights of brickwork, shattered; 60'0" high walls, badly bonded, with no other support from top to bottom, swayed and fell (164). The Act evaded major areas of construction, but made great play of 'greenhouses, vineries and aviaries'. No allowance was made to W.S.H. to build a lath shelter for his pigeons in his own backyard in Bermondsey (165) although slight relaxations were allowed to this control in the 1855 Act.

Relaxations were allowed in the trivial matter of corbelling chimneys - a waiver granted in March 1845 allowed chimneys to be 'gathered over'

in Third rate houses in Regents Park Terrace - but only on the third floor (166). The Official Referees cautiously allowed corbelling within certain limits in April 1846 (167) and by 1855, more generous allowances for chimney corbelling was set out in the new Act. One other harsh restriction had required proper walls of brick or stone to replace timber on the rebuilding of existing houses where most of the front had had to be removed - this too was modified, its interference with street widening schemes had been found to be severely expensive (168).

The Act was vague on the requirements for foundations and evasions were frequent. Eleven houses in Winchester St., Camberwell, were found to be set on no less than 14'0" of made up ground (169). No damp proof control was included in the Act, as we have noted earlier, but its necessity was apparent. One writer suggested in 1854 that all the footings and walls up to 3'0" above ground level should be of vitrified brick, and that the earth under the cellar floor be excavated to a depth of 3'0", a concrete layer put in "and covered over with rough plate glass, thereby preventing any smell or vermin from annoying the inmates". He also suggested that air bricks should be 9" above ground level - not below ground level as he had seen in the houses in Bemarten St, Caledonian Road (170). Amusing too were some of the attempts to avoid the Act altogether, a common device being to call a small building 'movable'. John Walker's building of a 'photographic establishment' in Upper St, Islington, in 1854 was such an example. Built of timber and glass, it contravened the Act - but Mr. Walker had set it on wheels 14" in diameter. Unfortunately the wheels were found on inspection to be below the level of the ground, and Mr. Walker lost his case (171).

Of the newer materials, hollow bricks were to fall foul of the Act, since they were not accepted as 'solid work'. The great arch ceiling of St George's Hall Liverpool used them effectively (172) and it was generally agreed that such bricks could produce walls "as strong as those in common bricks, though thinner and cheaper, such are also warmer and drier" (173). But they did not meet the requirements of the London Act. The test case came in 1853 when a Mr. Hodge built the Congregational Church and School at Battle Bridge, Clerkenwell, with "Norton and Bories patent hollow bricks". The official Referees overruled the poor District Surveyor's objections, confirming that "they

will be sound bricks and with cement and mortar will produce solid work as required by the Act for external walls and footings" (174). By the 1855 Act therefore, the words 'sound' and 'solid work' were replaced by 'hard and incombustible' and 'solidly put together' respectively.

The control of timber sizes for joists, rafters and purlins did not feature in the London Acts, although they had been included in the abortive Bill of 1843 (175) and were in the Liverpool Act of 1842. The need for them was surely obvious, as an 'Observer' noted in 1855, hoping to see them included in the new Act (176) - but the pressure of the Master Carpenters' Society was particularly strong. They appear in the later Model By-laws in 1890 and a reference to their earlier course in Liverpool is therefore necessary here. According to Joseph Boulton, the Liverpool rules were based on Tredgold's formula (177), but Tredgold's rules were merely elaborate 'rule of thumb' devices (178) and lacked precision. Mr. Hay, the architect for a church in Sackville Street, Liverpool, had used 10" x 6" purlins to span 14'0", at 6'6" spacing, whilst the Liverpool Act required 9" x 7" sections. Yet according to Tredgold, the 10" x 6" was stronger than the 9" x 7", although the latter contained more timber and complied with the Act (179). The Liverpool Act did not specify the method of fixing and it was quite in order to lay a joist, of the correct section, on its side, that is, in its weakest position. No mention was made of the species of timber, and distances were set between joists, rather than from centre to centre. The proposed amending bill of 1851 attempted to overcome these failings, "but it was too great a step forward" (180).

Materials other than brick or stone for walls were viewed with suspicion by the legislators. Glass constructions frequently met with opposition. George Godwin's own construction for a small glazed extension on a flat roof for "plants or taking portraits in the photographic way" caused controversy (181), and the glazed clerestory of St. Peter's Scotch Church in Liverpool had to be compared with the precedent set by St. John's and St. James' markets in the same city before the building surveyor would agree to its construction (182).

Concrete for walling was still a novelty, although it was used in foundation work. Hosking considered that "concrete ... is not to be regarded as a proper substance with which to form the lofty walls of

buildings in towns" (183) and although there is a reference to an early pair of cement concrete villas on the Isle of Wight (184), we have to wait until a later period (see page 191) for the main confrontation between this material and building control. We have referred to cast iron under the topic of fire; now its structural performance was also open to question. There was "the common custom in all large towns of omitting or removing the outer walls throughout the ground floor storey, on two sides of corner houses, to admit of returned shop fronts - a practice so full of danger as to condemn itself the moment it is reflected on" (185) - and the collapse of shop fronts was a constant recurrence (186). Used in conjunction with patent fireproof flooring systems its use appears to have been relatively more satisfactory. J.C.Christopher, a London District Surveyor saw Dr. Fox's patent system in use at a lunatic asylum near Bristol and remarked that 'the only repairs ever needed are performed by the gardener" (187). The development of wrought iron was proving more reliable, and with the box girders of the Menai Bridge as a successful example (188), the Railway Companies, exempt from the Buildings Act, were breaking new ground in their station buildings and shed roofs. But even there, there were failures. Barlow, later engineer of the St Pancras shed roof, designed a 'patent girder' bridge for the South Eastern Railway at Tooley Street. It collapsed in October 1850, to the delight of 'The Builder' who had anticipated its weakness and had looked to Brunel and Rennie to confirm its view. Whilst identifying possible iron buildings which might be expected to cause trouble, it noted that correspondence had been received about another iron building which many viewed with alarm, the 'iron building in Hyde Park', later to be known as the Crystal Palace. This important building was outside the control of the Building Act. It was indeed a building impossible within the Act (189) and in fact had its own private Act. The year of the Great Exhibition also witnessed the major calamity in Gracechurch St. when a four storey office building collapsed when a cast iron girder snapped:

"At present" said The Times" 15-20,000 persons daily trust their lives to the stability of these iron girders ... we are told that when an architect desires fireproof construction, they must rely upon cast iron girders" (190).

The point was also that, although walls could be carried on iron girders and pillars, the walls had to be of the thickness stipulated by the Act according to the rate of the building, regardless of the

fact that the entire wall was not built of solid brick (191). Hence there was an inevitable overloading by the superstructure bearing on the iron members. In spite of these failures with iron, T.L.Donaldson, a District Surveyor, called on smiths and ironfounders to 'support the intention of the legislative' and introduce more iron in building - presumably for fire safety:

"Why not cast iron cornices, as in Paris? Why not iron balconies and verandas? Why not iron bars over door and window openings, as well as chimney openings, particularly since nowadays no attention is paid to make voids over voids and solids over solids and the weight of walls comes over window openings. Why not iron bars over the whole length of a house, in cement, immediately over the openings? and iron hoop bond in place of timber bond in walls?" (192).

Timber bond was still allowed in the Act through the period, in spite of its dangers, although it was not to give support to the wall above (except for bressummers). Hosking sought its prohibition wherever possible, but 'The Builder' thought he was wrong to do so (193). It was a traditional and convenient means of tying the poorly built wall together, but in spite of its susceptibility to fire, rot and decay, it remained possible under the Act. The 1847 amending Bill had tried to restrict the bond timber to not more than one third the wall thickness, and to be set between brick or stonework facing, but it was felt that 'it will lead to much bad building' (194) and it did not reappear in the 1855 Act.

The final area within structure concerns the complex matter of wall thickness. In line with Hosking's recommendation that cross walls gave additional strength to buildings, the 1847 amending Bill acknowledged this and extended their use beyond the limits set in the 1844 Act. (see Table 4, sheet 13). The 1849 amending Bill took the wall thickness controls further, as noted earlier, and put all buildings, except public, in one class and allowed the same thickness to apply to both external and party walls within each rate (195). The number and height of the storeys regulated the thickness for the various rates (196). Seymour's Bill of 1851, whilst reverting in most matters to the 1844 Act, simplified the wall thickness rules, abolished the difference between the First and Second class and maintained the same thickness for the external and party walls (197). 'H' noted in his article 'Who can make a building Act' that this Bill preserved the fallacious idea that the stability of a building depended on the thickness of its external walls only:

"now it is very evident that the internal walls may carry much of the weight and besides, by acting as buttresses contribute very materially to the strength ... further, it is clear that there is no invariable proportion between the size of a building and the strength necessary for its walls, nor between the strength of its walls and their thickness. Yet upon such presumptions the Bill is founded" (198).

Seymour's revised Bill of July 1851 introduced a proportional system for heights and thicknesses of walls, party walls of the Third rate house for example "shall not be less in thickness at the top thereof than  $13\frac{1}{2}$ " and shall be of such thickness for not more than half their whole height, and thence downwards to the top of the footings shall not be less than  $17\frac{1}{2}$ ." External and party walls were again to be of the same thickness (199). But it was in Sir William Molesworth's Bill of 1855, described by 'The Builder' as "obscure and insufficient, if not wholly impracticable" (200) that the summit of absurdity in all building regulation was reached. The following example is surely proof enough:

"As to the thickness of such walls (external and party walls of houses) at their bases - the thickness shall be determined, in cases where the dwelling house does not contain any storey exceeding 12'0" in height, by adding together the following measurements, that is to say: 1. Fifteen times the height of the building, 2. Eight times the breadth, 3. Five times the length, and by taking the thousandth part of this sum for the thickness of the wall at its base; but if the length exceeds twice the breadth, it shall be lawful to take the sixtieth part of the sum of the height and the breadth for the thickness of the wall at its base. The thickness of the base of the wall, in cases where the dwelling house does contain any storey exceeding 12'0" in height, shall be determined by taking the thickness as before, and adding for every storey that exceeds 12'0" in height to such thickness one fortieth part of the excess of such storey over 12'0" (201).

Fortunately for posterity, these devious rules were removed from the Bill by the middle of May 1851. At the Institute of British Architects in June, Robert Hesketh discussed the whole problem in a lengthy and complicated paper (202). The idea of introducing cross walls and compartments, the wall thickness being set by the size of the compartment and not the whole buildings, was welcomed - it had the additional benefit of encouraging brick rather than timber for internal walls, to assist the prevention of fire spread. Hesketh had first suggested this to Seymour in March 1851. But the rules were still complex, based as they were on the results of Rondelet's experiments (see Table 4, sheet 13) (203). The discussion itself was involved, various rule of thumb methods were put forward, but the lack of any real scientific

understanding of the problem was painfully obvious. Almost in desperation, it was finally agreed that the existing rules in the 1844 Act were probably still the most realistic. (In the recast schedule in the Bill of June 1855, the 1844 rules were indeed retained, with only slight modifications (204).) During the discussion, William Tite, the Chairman, said that he was not too worried by the various formulae being discussed since he was sure, 'speaking as a practical architect', that the regulations would break down. Charles Barry considered that the existing schedule had been in use for a sufficiently long time, worked well, and needed no change. Such was the attitude of the elder leading architects to the regulations. Papworth was equally concerned at the proposal to abolish the system of dividing buildings into various rates, but it was Penrose who pointed out that it was the District Surveyors themselves who had raised doubts on the rating system - and he knew, since he had himself, as he said, worked on the preparation of the Bill (205). The legislators had thought it better to regulate the walls in themselves, rather than putting all buildings 'as it were, into five boxes of fixed size'. He also confirmed that Rondelet had indeed been the legislators' authority, and they had tested 'hundreds of examples' of walls. He knew many who agreed with him that the old rating system was inconvenient. The new general rule proposed was basically: when the length of a wall was not over half its height, then its thickness should be  $\frac{1}{50}$ th. of its height. A Mr Burnell countered all this, objecting to any alteration at all in the existing Act - "as the principle of all law was its certainty". As for Rondelet's formulae, he explained that the walls of the Strasbourg Railway Station in Paris were only 1'10" thick, and if Rondelets' rules had been applied, they would have needed to be 3'7 $\frac{1}{2}$ " thick, without buttresses, or 2'5" with buttresses. Alderman Cubitt preferred the new simpler rules. It was more rational, he felt, to take the height of each individual wall, rather than to consider the area of a building. With distinguished sagacity he added "The present is an age of reform, in which it would not do to uphold a system because it was old and well understood". But the Institute of British Architects was not aware of these characteristics of the age of reform. It approved a motion calling for the retention of the rating system as a basis of wall thickness rules and supported a general adherence to the existing schedules of the 1844 Act (206).

At the third reading of the Bill in July 1855, the controls on wall



thicknesses for public buildings were removed, leaving this area, along with floors, roofs, galleries and stairs to the direct approval and satisfaction of the District Surveyors- much to the concern of 'The Builder'. "Why regulate minor matters, but not important areas?" (207). The Act itself, as finally passed in August 1855, did away entirely with the system of rates, simply dividing buildings into dwelling houses and warehouses for the purposes of wall thickness regulations. It should be noted with regard to public buildings however that they still came generally within the Act, even though the function of the District Surveyor was more specific in their cases. In clause 30 it was stipulated that 'every public building shall, throughout this Act be deemed to be included in the term building and be subject to all provisions of this Act in the same manner as if it were a building erected for a purpose other than a public purpose.'

\*\*\*

### Health

The provision of the external yard to the house, as open space for ventilation of the dwelling, caused problems in interpretation. It was an obvious one for the speculative builder to try and circumvent, since any subtractions of 'valuable' building land, for such reasons, was an interference with his business. For example, a builder of three houses at the corner of St. Martin's Lane and Cranbourne St in 1845 thought that the provision of one and three quarter "squares" for yards for three houses to be quite sufficient (instead of the stipulated three "squares") and in this he claimed to be supported by an 'eminent architect'. The Official Referees confirmed that it had been the intention of the legislature to provide the minimum space for each house, but as 'The Builder' pointed out, the Schedule in the Act did not say that 'the area should be appropriated exclusively to this one house, any more than that the street should be" (208). There seemed to be nothing to prevent the erection of three or more houses around the area of only three quarters of a square - the minimum allowed above first floor level. It was further held that a w.c. could not be built on the yard to thereby reduce its area below the minimum (209), and although the proposed Bill of 1847 attempt to rectify these matters (210), it was not until 1855 that the Act specified the hundred square

feet of space to belong exclusively to the building. The worry over the effect of this on shopkeepers was still maintained (211), but the clause remained and duly came through to the Model By-laws, though with an increased area.

This clause was included not only for air, but also for daylight. The need to relate window size and room size, during the period when the repeal of the window tax seemed imminent (p. 83) has already been noted. Although the Act of 1855 did not take up this point, a new interest in daylight penetration into buildings followed the repeal of the tax in 1851. One writer held the theory that light falls on and enters a building at an angle of  $45^{\circ}$ , and therefore if no erection infringed the  $45^{\circ}$  line, there would be adequate light in the room. This erroneous theory was based on the 1844 Act which specified street widths to be the same as the height as the buildings on either side "which is in effect  $45^{\circ}$ " (212). Earlier, Hosking in 1847 had considered sun penetration in relation to streets, claiming that over-wide streets brought the backs of rows of houses too close together and prevented buildings being lighted from opposite sides (213).

Robert Hesketh propounded a complicated geometrical explanation on daylight in his paper to the Institute of British Architects on May 17, 1852 (214), but the matter was not incorporated in the 1855 Act, and the only clauses relating to window sizes, and then only in relation to cellars, were taken out of the Building Act and incorporated in the Metropolis Local Management Act of the same year. Nevertheless, the provision of window sizes in relation to the floor area of the room was to appear in the Form of By-laws just three years later, in 1858.

The relationship between street widths and building heights was set in the 1844 London Act and also in the Liverpool act of 1842. It is of interest to hear Newlands, the Liverpool Borough Engineer's explanation of this in 1848, since London saw fit to exclude it from its 1855 Act.

"That these should be a relation betwixt the width of streets and the height of houses on each side is self evident. The minimum width of streets in towns should be fixed by consideration of health, and not of traffic; and the relative height of the houses should be such as to admit radiant light and air to the street for the greater part of the day. When the houses are in height equal to about two thirds of the width of the street, this will be ensured. Conversely, if houses are two storeys high above the street, and few houses less than two

storeys in height are built, the minimum width of a street will be found to be 40'0" [the same as the London standard]. To ensure perfect ventilation, every street should be straight or should form a portion of a simple curve, without bends, turning or projections beyond the general line. There should be no back passages of less width than 10'0" to allow room for a dust cart, and these passages should, like the streets, be free from bends or projections" (215).

But London decided to relax this control, and indeed it excluded a number of the health requirements which, although they later appeared in the 1848 and 1875 Public Health Acts, did not exist in London until 1891. In his article 'Who can make a Building Act'. 'H' wrote in 1851:

"Lord Seymour's Bill.....contains few regulations of a sanitary nature and most of these are very unsatisfactory. For instance, although it prescribes the minimum width of new streets, it does not limit the height of the buildings in proportion to the width of the street, as is done by the Local Act in Liverpool ... The observance of some such proportion is evidently requisite to secure the full benefits of light and ventilation. Again, The Bill provides that no room without a window towards a street or alley shall be inhabited. This provision will not prevent the erection of houses back-to-back which cannot be properly ventilated, and are necessarily insalubrious. The construction of cellars for habitants is not prohibited, as they are in places where the Public Health Act is in operation, nor are the regulations for existing cellar dwellings in the Bill so protective of the public health as those of that Act" (216).

In point of fact, cellar and street width regulations were to be taken from The Building Act and incorporated in The Metropolis Local Management Act in 1855, but no relationship between heights and widths remained in the legislation - nor in the Model By-laws - and it only reappeared in London in 1862 (see p.170). (Drains and cesspool controls were also incidentally transferred from The Building Act, this time into the Metropolitan Sewers Act of 1848 (217).

The problem of the removal of 'vitiating air' from the interior of buildings was the preoccupation of many, and various patent systems were invented. C.Candland proposed that the legislation should require an ornamental ventilator in the ceiling of every room (218) and Toynbee, addressing the Institute of British Architects in 1847 (219) proposed that the law should require no living, sleeping or workroom to be less than 144 sq.ft.in area, nor less than 8'0" in height and that such rooms should have one window at least, opening at the top - a requirement to appear in the Form of By-laws of 1858. Besides having a fireplace, such rooms were also, he proposed, to have some method of allowing the foul air to escape in the upper part of the room and a means of admitting a continuous supply of fresh air. For this he favoured Leslie's Patent

Ventilating Stove, but, as with many of these devices, their use was in fact hindered by the chimney clauses in the Building Act, which prevented the use of the small diameter flues that these stoves required. Devices to remove the products of the combustion of gas from public buildings and a requirement for all public buildings, schools, workshops etc. to have a means of ventilation approved by a Medical Officer of Health, were also suggested by Toynbee. In this he was repeating the same matter, in the control of ventilation in public buildings, as The Towns Improvement Clauses Act of the same year (see Chapter III page 137). The 1853 amending Bill for the Building Act appears to have taken note of this, since in Section 1, it required a 'foul air tube to be put in the ceiling of every apartment of buildings here - after erected'. But it effectively nullified this in Section 2 by specifying the Patent Ventilating Apparatus of one Donald Grant of Greenwich (as mentioned earlier, page 84). No one had apparently heard of Grant or his apparatus. A District Surveyor asked, through the columns of 'The Builder', Viscount Hutchinson who had introduced the Bill "to make provision that the foul air shall ascend the said tube in section 1 and to ask Mr Grant to give a description of his apparatus" (220). Grant claimed to have given details to the House of Lords in 1846 and again in 1848 (221) - but no details appeared in 'The Builder' and, as we have seen, this obscure measure was quickly abandoned. More ingenious, though thankfully for the future of building regulation and building generally it was not implemented, was the suggestion Mr. W.A. Boulnois made to the Institute of British Architects in 1854. This was "that every house to be built or rebuilt should have a flue in the party wall for the use of the Commissioners of Sewers if they need it to ventilate the sewer at that point - this does not seem impractical, perhaps it will be considered in the new Building Act which is in the hands of the Board of Health" (222). The planning, legal and administrative problems of this suggestion are rather frightening to contemplate.

\*\*\*

Looking back at the Metropolitan Building Act of 1844, and considering its course up to 1855, we can begin to see more clearly its significance, both in its own context and in the longer term of the development of building regulation.

In national terms its contents were not entirely original, since Liverpool had secured many of the same controls in its own building act just two years before. It is important in our context as the link with the traditional pattern of building regulation of London as it came down from the 18th century, the incorporation of the recommendations for certain 'health' controls made in 1840, the clauses proposed in the abortive Bills of Lord Normanby, and the later developments in the Model By-laws of the mid-century. It was significant in the fact that it was the first major new Building Act in London for seventy years. It put onto the statute books for the first time many of the concepts which had been so hastily drawn up and then lost in the rush to produce Lord Normanby's Bills. At the time it was also seen as being a possible prelude to a national measure, or at least as being worthy of emulation by the rest of the country - a view that was not however necessarily shared outside the Metropolis.

The controls which were new were the health regulations - for cellars, streets, space about buildings and drainage. The most important perhaps, because of its implications on the planning of the town, was the clause regulating street width in relation to building heights. But its significance and effect on density and economics of development were not fully realised at first. When they were, the clause was soon to be dropped, and it failed to reappear in the Metropolitan Building Act of 1855. This clause also revealed a further development in the use of what may be termed 'relationship controls' - that is, when one variable element is regulated in relation to another variable element. This is a rather more sophisticated control than the simpler and older form of the direct one-to-one control.

Drainage controls do not receive the detailed attention that they later attract, partly due to the lack of understanding at this time of their full significance in terms of health, but also, more practically, because of the cost, and because there was little in the way of proper civic main drainage systems into which house drainage could connect. It was still left therefore in the inefficient hands of the local vestries.

The origins of the actual dimensions used in the regulations would seem to be based largely on the measurement of existing and commonly accepted standard dimensions inherent in the building tradition. The size of

the openable window in the cellar for example, at 9 sq.ft., may be derived simply from the area allowed for the almost square cellar window of the later Georgian period. The width of the opening in the brickwork was approximately 3'6", which, allowing for the exclusion of the sash frames, gave an opening size of some 9 sq.ft. Such an argument is perhaps supported, though not proven, by the fact that much of the Metropolitan Building Act of 1844 followed its predecessor of 1774 in its constructional controls, based on the traditional construction which remained in operation for much of the nineteenth century.

Certain builders, such as Thomas Cubitt, revealed more advanced thinking in construction as their wider experience and more business-like approach to building would tend to encourage, but they were few and far between. The architectural profession had yet to make a mark in the 1840's; it was still in its infancy and tended to be conservative in its opinions. The elder members, such as Charles Barry and William Tite, as with their elder colleagues in the legal profession, seemed reluctant to accept the need for change. It may be argued that they operated at a higher architectural level, well above the mundane level embodied in the Building Acts. But there were signs as the period progressed of more awareness on the part of the architect. There was for example, a growth of belief in the correctness, both structurally and ethically, of construction, which may be attributed to the influence of Pugin. There was more experiment, more debate, newer materials to consider and new building types in demand. There was a search for more scientific explanations and for justifiable formulae. One example of this was the lengthy discussion at the Institute of British Architects about the formula for wall thicknesses. Another was the realisation, embodied in the amending Bill of 1847 of the structural relevance of the cross wall in its relation to the external wall. This idea of a relationship between elements of a building, how they affect each other, is of particular interest. It continues right throughout this history, even reappearing in unfortunate and surprising circumstances, such as when the R.I.B.A. itself failed to accept its validity in the debate over the steel frame controls in 1909 (see page 524). Our present regulations, it may be noted, are divided into separate topic sections for convenience, but they are also largely independent of each other and therefore tend to ignore the reality of building, in which all these elements interact with each other.

To return to the nineteenth century, our second route into the subject is now completed for the present, although it will be resumed in chapter IV. We must now turn to the third of our routes and in the next chapter continue the threads of the public health movement from the point at which they were left in chapter I and pursue the theme of municipal reform and the development of the local improvement acts.

\*\*\*\*\*

NOTES TO CHAPTER II

- 1 C.C.Knowles and P.H.Pitt, 'The History of Building Regulation in London 1189-1972', London, 1972.
- 2 B.Vol. 1 No. 14 13 May 1843 p.169.
- 3 B.Vol. 1 No. 2 18 Feb 1843 p.19 (letter from John Reid, District Surveyor for Lambeth).
- 4 Ibid.
- 5 H.Vol. 68 10 April 1843 p.744.
- 6 B.Vol. 1 No. 12 29 April 1843 p.137.
- 7 Ibid.
- 8 Ibid.
- 9 B.Vol. 1 No. 17 3 June 1843 p.210.
- 10 B.Vol. 1 No. 18 10 June 1843 p.221. (Swan and Edgar's had put tall corner windows into their shop in the Quadrant, Regent Street, in 1840).
- 11 B.Vol. 1 No. 21 1 July 1843 p.253.
- 12 B.Vol. 1 No. 26 5 Aug 1843 p.312.
- 13 Damage by Fire (Metropolis) Bill.
- 14 H.Vol. 73 29 Feb 1844 p.393 and B.Vol. 2 No. 57 9 Mar 1844 p.109.
- 15 H.Vol. 73 12 Mar 1844 p.844.
- 16 H.Vol. 73 Ibid.
- 17 B.Vol. 2 No. 60 30 Mar 1844 p.163.
- 18 B.Vol. 2 No. 62 13 Apr 1844 p.197.
- 19 H.Vol. 73 29 Mar 1844 p.1616.
- 20 H.Vol. 74 17 May 1844 p.1251.
- 21 H.Vol. 76 16 July 1844 p.919.
- 22 H.Vol. 76 16 July 1844 p.914.
- 23 H.Vol. 76 22 July 1844 p.1176.
- 24 H.Vol. 76 22 July 1844 p.1144 and p.1505; and 2 Aug 1844 p.1669.
- 25 H.Vol. 76 9 Aug 1844 p.1944.
- 26 The Times, 18 Dec 1844 p.4 col.c.
- 27 Report of the Select Committee on the Regulation of Buildings and Improvement of Boroughs 1842. Evidence of H.Biers, para.490-3.
- 28 Ibid. Evidence of T.Chawner, para,98.
- 29 Ibid. para.91.
- 30 Report of the Royal Commission on the State of Large Towns and Populous Districts 1844-5 Minutes of Evidence, para.291.
- 31 Ibid. para.292.
- 32 Ibid. para.312-3.
- 33 Ibid. para.414-5.
- 34 See chapter I page
- 35 Ibid. Evidence of W.Hosking, para.273.
- 36 Ibid. para.266.
- 37 Ibid. para.321.
- 38 B.Vol 2 No.73 29 June 1844 p.322.
- 39 Ibid.
- 40 Ibid.
- 41 State of Large Towns 1844-5, Evidence of T.Cubitt, para.208.
- 42 Ibid. Evidence of W.Hosking, para.314-6.
- 43 Ibid. para.320.
- 44 Ibid. para.350 and 359.
- 45 Ibid. para.356 and 358.
- 46 Ibid. para.417.
- 47 B.Vol 2 No.73 29 June 1844 p.322.
- 48 B.Vol 2 No.74 6 July 1844 p.331.
- 49 Ibid. p.333.



- 50 Ibid.
- 51 Ibid.
- 52 Ibid.
- 53 Ibid. p.332
- 54 Report of the Select Committee on the Regulation of Buildings and Improvement of Boroughs, Evidence of T.Chawner, para.68.
- 55 B.Vol.3 No.109 8 March 1845 p.109.
- 56 State of Large Towns 1844-5, Evidence of W.Hosking, para. 326-7.
- 57 Ibid. paras. 284,326, 327 and 331; and evidence of Savage, para. 660; and H.Austin, para. 776-9.
- 58 See chapter I, page 31 and page 39.
- 59 B.Vol.2 No.74, 6 July 1844 p.334.
- 60 B.Vol.2 No.72 22 June 1844, p.307-8.
- 61 State of Large Towns 1844-5, Evidence of H.Austin, para. 831.
- 62 Ibid. para.832.
- 63 Ibid. para.833.
- 64 Ibid. para.834.
- 65 Ibid. evidence of W.Hosking, para.333.
- 66 Ibid. para.329.
- 67 Ibid. para.334.
- 68 Ibid. para.311.
- 69 Ibid. para.294.
- 70 Ibid. para.363.
- 71 Ibid. evidence of T.Cubitt, para.174-181.
- 72 B.Vol,2 No.75 13 July 1844 p.343
- 73 State of Large Towns 1844-5, evidence of W Hosking, para.334.
- 74 Ibid. para.287.
- 75 B.Vol.3 No.100 4 Jan. 1845 p.1.
- 76 B.Vol.3 No.101 11 Jan. 1845 p.13.
- 77 B.Vol.3 No 103 25 Jan. 1845 p.37.
- 78 Ibid.
- 79 B.Vol.3 No.137 20 Sept. 1845 p.446.
- 80 B.Vol.3 No.140 11 Oct. 1845 p.486.
- 81 B.Vol.3 No.149 13 Dec. 1845 p. 593.
- 82 The Times, 27 Feb. 1846 p.5 col.f.
- 83 The Times, 6 Mar. 1846 p.4 col.c.
- 84 B.Vol.4 No.163 21 Mar. 1846 p.133.
- 85 B.Vol.4 No.160 28 Feb. 1846 p.97.
- 86 B.Vol.4 No.157 7 Feb. 1846 p.61.
- 87 B.Vol.4 No.159 21 Feb. 1846 p.85.
- 88 B.Vol.4 No.161 7 Mar. 1846 p.113.
- 89 9 and 10 Vic.cap.5.
- 90 B.Vol.4 No.173 30 May 1846 p.261.
- 91 B.Vol.4 No.180 18 July 1846 p.337.
- 92 B.Vol.5 No.223 15 May 1847 p.231.
- 93 B.Vol.5 No.227 12 June 1847 p.273. See also Table 4, sheet 12.
- 94 B.Vol.5 No.228 19 June 1847 p.238.
- 95 B.Vol.5 No.249 13 Nov. 1847 p.537.
- 96 B.Vol.6 No.257 8 Jan. 1848 p.23.
- 97 11 and 12 Vic.cap.163.
- 98 11 and 12 Vic.cap.112.
- 99 B.Vol.7 No.339 4 Aug. 1849 p.367.
- 100 B.Vol.7 No.341 18 Aug. 1849 p.385 and B.Vol.8 No.363 19 Jan. 1850 p.278.
- 101 B.Vol.8 No 379 11 May 1850 p.219.
- 102 B.Vol.9 No.417 1 Feb. 1851 p.80.
- 103 B.Vol.9 No.421 1 Mar. 1851 p.131.

- 104 Ibid.
- 105 B.Vol.9 No.418 8 Feb. 1851 p.88.
- 106 B.Vol.9 No.423 15 Mar. 1851 p.163-5.
- 107 B.Vol.9 No.428 19 Apr. 1851 p.248-9.
- 108 B.Vol.9 No.442 26 July 1851 p.459.
- 109 Ibid.
- 110 Ibid.
- 111 B.Vol.10 No.486 29 May 1852 p.347.
- 112 B.Vol.10 No.488 12 June 1852 p.379.
- 113 B.Vol.10 No.509 6 Nov. 1852 p.706.
- 114 B.Vol.11 No.546 23 July 1853 p.476 and C.C.Knowles and P.H.Pitt, 'The History of Building Regulation in London 1189-1972', London, 1972, p.56.
- 115 B.Vol.11 No.556 1 Oct.1853 p.618.
- 116 B.Vol.11 No.558 15 Oct. 1853 p.639.
- 117 B.Vol.12 No.581 23 Mar. 1854 p.158.
- 118 B.Vol.12 No.590 27 May 1854 p.283.
- 119 B.Vol.13 No.635 7 Apr. 1855 p.167.
- 120 B.Vol.13 No.639 5 May 1855 p.205.
- 121 B.Vol.13 No.640 12 May 1855 p.221.
- 122 B.Vol.13 No.645 16 June 1855 p.277-9.
- 123 B.Vol.13 No.647 30 June 1855 p.304.
- 124 B.Vol.13 No.650 21 July 1855 p.337.
- 125 B.Vol.13 No.651 28 July 1855 p.354.
- 126 18 and 19 Vic.cap.122.
- 127 B.Vol.13 No.673 29 Dec.1855 p.629.
- 128 B.Vol.4 No.180 18 July 1846 p.337.
- 129 B.Vol.6 No.257 8 Jan. 1848 p.14. Also, the carpenters strike in Paris in 1840 had led to the use of rolled iron joists filled between with coarse plaster of Paris. R.I.B.A. Journal Vol.VII. No.4, 23. Dec. 1899, p.59.
- 130 B.Vol.6 No.297 14 Oct. 1848 p.498.
- 131 B.Vol.6 No.301 11 Nov. 1848 p.541.
- 132 Quarterly Review, Vol.XCVI, 1855, No.cxcii, p.31.
- 133 B.Vol.6 No.273 29 Apr. 1848 p.209.
- 134 B.Vol.7 No.318 10 Mar. 1849 p.116.
- 135 B.Vol.13 No.625 27 Jan. 1855 p.46.
- 136 Quarterly Review, Vol.XCVI 1855, No.cxcii, p.28.
- 137 Ibid. p.30.
- 138 Ibid. p.31. It may be noted also that the National Gallery had originally had arches built of fire pots - RIBA Journal, Vol.VII, No.4, 23 Dec. 1899. p.69.
- 139 Ibid. p.30 and (6 and 7 Vic.cap.cix 24 Aug.1843).
- 140 Ibid. p.32.
- 141 B.Vol.6 No.297 14 Oct. 1848 p.497.
- 142 B.Vol.6 No.308 30 Dec. 1848 p.627.
- 143 B.Vol.180 No.180 18 July 1846 p.337.
- 144 B.Vol.7 No.317 3 Mar. 1849 p.47.
- 145 Ibid.
- 146 B.Vol.3 No.147 29 Nov. 1845 p.570.
- 147 B.Vol.3 No.151 27 Dec. 1845 p.618.
- 148 B.Vol.4 No.181 25 July 1846 p.351.
- 149 B.Vol.5 No.209 6 Feb. 1847 p.58.
- 150 B.Vol.9 No.431 10 May 1851 p.294.
- 151 Quarterly Review, Vol.XCVI, 1855, No.cxcii, p.16.
- 152 Ibid.
- 153 B.Vol.4 No.190 26 Sept. 1846 p.460 and No.192 10 Oct. 1846 p.484.

- 154 B.Vol.5 No.204 2 Jan 1847 p.5.
- 155 B.Vol.8 No.411 21 Dec. 1850 p.601.
- 156 B.Vol.9 No.432 17 May 1851 p.313 and No.434 31 May 1851 p.349.
- 157 B.Vol.11 No.518 8 Jan. 1853 p.31.
- 158 B.Vol. 12 No.583 8 Apr. 1854 p.191.
- 159 G.M.Trevelyan, 'A Shortened History of England', London, 1942, p.459.
- 160 B.Vol.10 No.471 14 Feb. 1852 p.97.
- 161 B.Vol.11 No.564 26 Nov. 1853 p.709.
- 162 Ibid.
- 163 B.Vol.2 No 75 13 July 1844 p.344.
- 164 B.Vol.11 No.565 3 Dec. 1853 p.121.
- 165 B.Vol.3 No.123 14 June 1845 p.279.
- 166 B.Vol.3 No.117 3 May 1845 p.205.
- 167 B.Vol.4 No.167 18 Apr. 1846 p.182.
- 168 B.Vol.4 No 191 3 Oct. 1846 p.470.
- 169 B.Vol.5 No.225 29 May 1847 p.249.
- 170 B.Vol.12 No.583 8 Apr. 1854 p.192.
- 171 B.Vol.12 No.574 4 Feb. 1854 p.61.
- 172 B.Vol.7 No.324 21 Apr. 1849 p.183.
- 173 B.Vol.9 No.431 10 May 1851 p.294.
- 174 B.Vol.11 No.547 30 July 1853 p.491.
- 175 B.Vol.8 No.363 19 Jan. 1850 p.27.
- 176 B.Vol.13 No.632 17 Mar. 1855 p.130.
- 177 J.Boult, 'Remarks on the Liverpool Building Act' A Communication to the Liverpool Architectural and Archaeological Society, 1856.
- 178 B.Vol.11 No.568. 24 Dec. 1853 p.773. An example of one of Tredgold's rules is as follows:- For the size of joists, divide the square of the length in feet by the breadth in inches, and the cube root of the quotient multiplied by 2.2 for fir and 2.3 for oak, will give the depth in inches.
- 179 B.Vol.7 No.338 28 July 1849 p.353. (The 9"x7" broke at 13,365lbs and the 10"x6" at 23,357lbs).
- 180 J.Boult, op.cit.
- 181 B.Vol.5 No.220 24 Apr. 1847 p.190.
- 182 B.Vol.6 No. 300 4 Nov. 1848 p.533.
- 183 W.Hosking, 'A Guide to the Proper Regulation of Buildings in Towns as a Means of Promoting and Securing the Health, Comfort and Safety of the Inhabitants', London, 1848, p.94.
- 184 B.Vol.10 No.490 26 June 1852 p.414.
- 185 B.Vol.6 No.257 8 Jan. 1848 p.14.
- 186 B.Vol.6 No.273 29 Apr. 1848 p.209 and B.Vol.6 No.284 15 July 1848 p.346.
- 187 B.Vol.6 No.301 11 Nov. 1848 p.542.
- 188 Ibid.
- 189 B.Vol.8 No.407 23 Nov. 1850 p.553.
- 190 The Times, 22 May 1851 p.5 col.e.
- 191 B.Vol.9 No.431 10 May 1851 p.294.
- 192 B.Vol.9 No.463 20 Dec. 1851 p.796.
- 193 B.Vol.5 No.254 18 Dec. 1847 p.597.
- 194 B.Vol.5 No.224 22 May 1847 p.239.
- 195 B.Vol.7 No.341 18 Aug. 1849 p.386.
- 196 B.Vol.8 No.363 19 Jan. 1850 p.28.
- 197 B.Vol.9 No.423 15 Mar. 1851 p.163.
- 198 B.Vol.9 No.431 10 May 1851 p.194.
- 199 B.Vol.9 No.442 26 July 1851 p.459.
- 200 B.Vol.13 No.639 5 May 1855 p.205.
- 201 Ibid.

- 202 R.Hesketh 'As to the Method which it is most advisable to adopt in the Metropolitan Building Act for regulating the thickness of walls'. Address to the Institute of British Architects, 11 June 1855.
- 203 J.B.Rondelet, 1734-1829  
Architect, Professor at 'École Spéciale d'Architecture' and author of major treatise on building construction : "Traité théorique et pratique de l'art de bâtir", Paris, 1802-1817.
- 204 An example of these modifications was as follows:- 'Every external or party wall for houses to be in thickness at least 1/15 the height of the storey and 1/12 in the case of warehouses'.
- 205 B.Vol.11 No.524 19 Feb. 1853 p.119.  
(Mr T.Nelson, speaking on the subject, said that the rates in the Act in effect restricted a poor man's dwelling to 25'0" x 16'0", i.e. 400 sq.ft. or the four squares of the fourth rate house. "It was absurd to put restrictions on the size of houses, any more than it was to put the extent of ships, mills or other buildings. In the last 100 years, sizes of houses in Paris had increased, whilst those in London had decreased. 'A sort of mésquin appearance was given to our public buildings and our countrymen were classified as inferior to their continental neighbours as architects').
- 206 B.Vol.13 No.645 16 June 1855 p.277-9.
- 207 B.Vol.13 No.651 28 July 1855 p.354.
- 208 B.Vol.3 No.109 8 Mar. 1845 p.109.
- 209 B.Vol.4 No.156 31 Jan. 1846 p.51.
- 210 B.Vol.5 No.224 19 June 1847 p.238.
- 211 B.Vol.13 No.651 28 July 1855 p.354.
- 212 B.Vol.10 No.470 7 Feb. 1852 p.83.
- 213 W.Hosking, op.cit. p.69.
- 214 B.Vol.10 No.487 5 June 1852 p.363 (Entitled 'The Admission of daylight into buildings, particularly in the narrow and confined localities of towns').
- 215 B.Vol.6 No.294 23 Sept. 1848 p.457.
- 216 B.Vol.9 No.431 10 May 1851 p.294.
- 217 11 and 12 Vic.cap.112 sec 47.
- 218 B.Vol.4 No.162 14 Mar. 1846 p.125.
- 219 B.Vol.5 No.219 17 Apr. 1847 p.179.
- 220 B.Vol.11 No.546 23 July 1853 p.476.
- 221 B.Vol.12 No.589 20 May 1854 p.272.
- 222 B.Vol.12 No.582 1 Apr. 1854 p.170.
-

	SELECTED CLAUSES relating to building design and construction Summary of contents	LINKS	
		ANTE	POST
cl.5 and 53 Sch.K	<p><b>HABITABLE CELLARS</b> (Lowermost rooms, in this act) Floor at least 3'0" below street level. Open area: 3'0" wide, at either front, back or external side, and extending the full length of such side. Open area 5'0" x 2'6" in front of the window (but may have iron grating over). Fireplace and window required. Window size to be 9 sq.ft.min. of which half to be openable. Floor to be 6" above level of outside area. Ceiling height = 7'0" min. (1) Lowermost room must be properly drained.</p>	T3.c13-c15  (1) L'pool 1842	T6.c103 and Public Health Act 1848  (1) T5.c119
cl.5 and 52 Sch.I  Sch.K	<p><b>STREETS</b> Streets 40'0" min. width, between fronts of buildings. If buildings fronting street are more than 40'0" high then width to be equal to height of building. Alleys and Mews 20'0" wide min. with same formula as for streets for heights of buildings. Two entrances for each alley, to be full width of alley, and one to be open from the ground upwards. Every building of class 1 to have road access for scavengers' cart.</p>	T3.c18-c19	T6.S1
Sch.D part 1	<p><b>STRUCTURE</b> Foundations and Footings: All walls, to be on a constructed footing, on solid ground or other sufficient foundation.  Walls to stand equally on each side in relation to the top of the footing. Footings to be of brick or stone, set in mortar or cement. Sizes of footings are shown on the wall thickness schedule - see Table 4, sheet 10.</p>	T2.c23  London 1774	T6.ScI
Sch.D pt. II	<p><b>External Walls:</b> To be of sound bricks or stone, laid in and with mortar or cement.</p>	T3.c30	

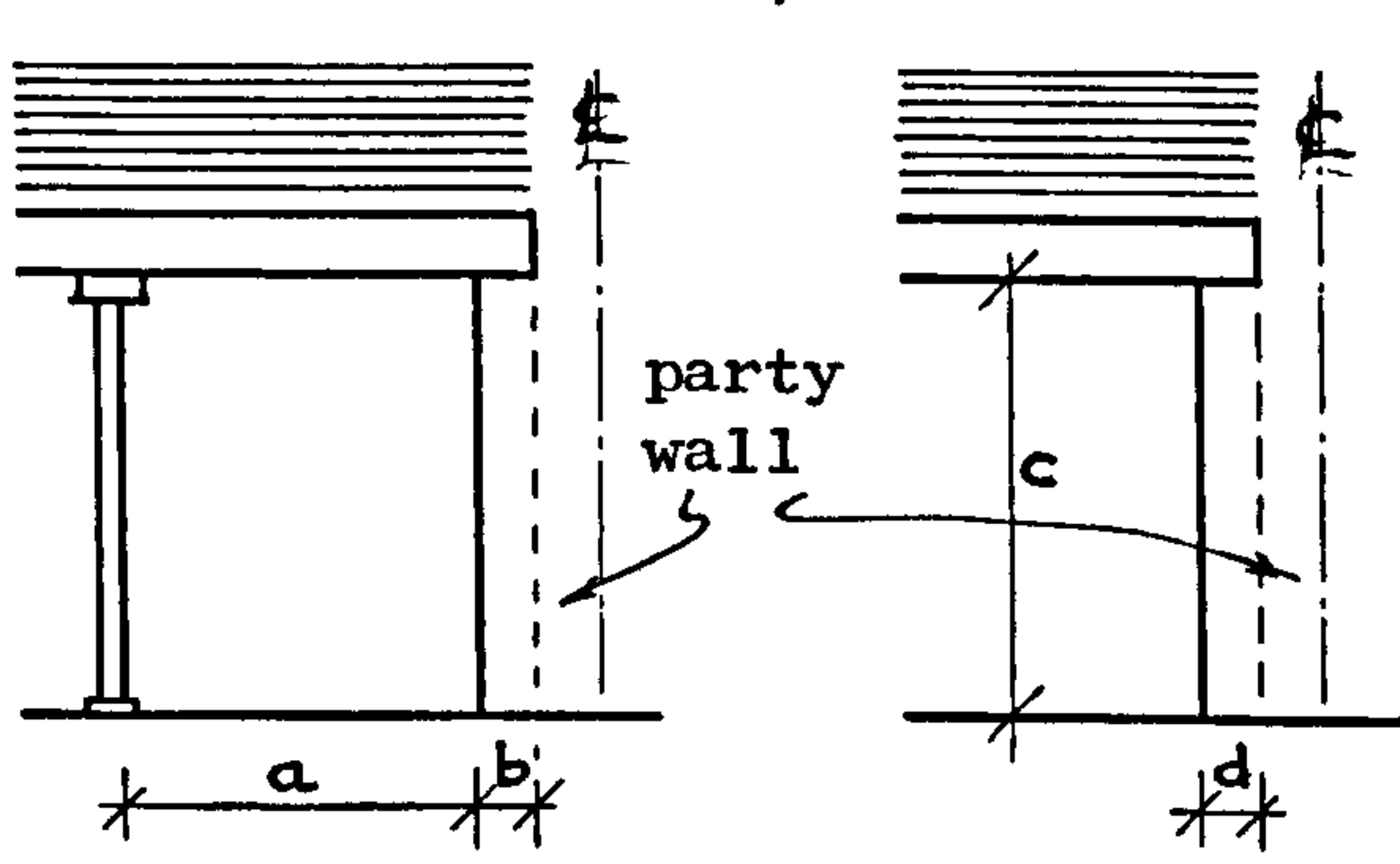
<p>Thickness of walls - see schedule T4.s10. (for rules involving cross walls - see T4 s12).</p> <p>Recesses: allowed in external wall if <math>8\frac{1}{2}</math>" of thickness still remains. Timber and iron allowed in walls for lintels, plates, bonds, corbels, etc No timber to be nearer than 4" to external face of wall. (but tiers of doorcases to warehouses can be 2" from wall face), No timber, except for bressummers, to be in wall so that wall above depends on it for support.</p> <p>Openings in Front Walls: Bressummers adjacent at one end to a party wall to be carried on stone or iron corbel or template. This to be tailed into the wall for at least <math>\frac{2}{3}</math> the thickness of the wall. In addition, a bearing required on a pier (brick or stone) or column (iron or timber) as well as by the party wall. If both ends of bressummers are carried by party wall, then at least 2 columns or piers also required; alternatively, returns of wall under ends of bressummers allowed, viz:</p>  <p>If <math>a=6'0''</math> then <math>b=4''</math> If <math>a=12'0''</math> then <math>b=5''</math> If <math>a=18'0''</math> then <math>b=6''</math> etc.</p> <p>If <math>c=16'0''</math> then <math>d=8\frac{1}{2}''</math> If <math>c=17'0''</math> then <math>d=9\frac{1}{2}''</math> If <math>c=18'0''</math> then <math>d=10\frac{1}{2}''</math> etc.</p> <p>Supporting return wall to be same thickness as bressummer.</p>	T3.c30	T6.ScI
	London 1774	
	T3.c30	London 1774

Sch.D Part III	<p>Parapets to External Walls : Min 12" high above the highest part of a gutter adjacent to an external wall. Thickness of parapet = 13" (1st and 2nd rate), 8½" elsewhere.</p>	T3.c33	T6.c16
	<p>Party Walls : To be of similar construction to external walls. Timber allowed into party walls for beams, etc., to a depth of 4" min from centre of party wall. Ends of timbers could be carried on iron shoes or stone corbels, built into party wall for at least ½ its thickness. Top of party wall to have one course of stock bricks, on edge, or other coping of waterproof and fireproof covering. For thicknesses of party walls see Table 4 sheet 10.</p>	T3.c32	T6.ScI
	<p>Openings in Party Walls : First class: allowed, but if united houses total more than 1400 sq.ft., then to be approved by Official Referees. Second class: 8'0" x 6'0" wide max. Brick, stone, iron for floor, jambs head. Wrought iron door on both sides of opening, ¼" thick. No woodwork.</p>	London 1774	T8.c27
	<p>Recesses and Chases : With official Referee approval only. Back of recess to be 7" min. from centre of party wall in lowest storey, 4" elsewhere. No chase to be less than 9" from front or back wall, no two chases on same side of wall to be nearer than 7'6", no chase to be wider than 9".</p>	T3.c48	T6.c28
Sch.D part III	<p>Party Walls above Roofs : To project 18", measured at right angles to the slope of roof. Adjacent to gutter, height to be 2'0" in First class and 3'0" in second class buildings. If turret, dormer, lantern light, etc., is within 5'0" of party wall, then wall to be carried up 18" higher and 18" wider than the turret/dormer.</p>	T3.c47	T6.c18
		London 1774	T6.c17

Sch.D part IV	<p><b>Party Arches :</b> In buildings with intermixed properties, such intermixed properties must be separated from each other by party walls and party arch or stone floor - or floor of iron girders or brick arches etc. 9" thick arch if span is 9'0" max. 13" thick arch if span exceeds 9'0" and with proper abutments.</p>	London 1774	T6.c24
Sch.D part V	<p><b>Buildings over Public Way :</b> Basically as for party arches. (This Act also covered the administrative aspects of party fence walls - i.e walls on party boundaries).</p>		T6.c25
Sch.F cl.5	<p><b>Chimneys :</b> Stack to have similar foundations and footings as adjoining wall. No overhanging or corbelling allowed except: in First rate : above ceiling of third storey in Second and Third rates : above ceiling of second storey. On brick, stone or iron corbels to a max. of 9" projection. Angle chimneys allowed only if width of breast not over 5'0", supported on iron girder, brick arch or stone landing, 4" thick min. tailed 9" min. into the angled walls. Jams = 8½" min. width. Breast, Front, Back, Withe = 4" min. Flue = 8½" min internal diameter. Inside, and outside face of flue next to interior of building to be rendered or pargetted. No timber allowed over opening in chimney breast. Opening to be arched over with brick or stone arch with iron bar, built 9" into each side to tie in abutments wherever breast projects more than 4½" from wall, and where jambs are less in width than 2/3 of the opening. No timber in any wall under chimney opening to be within 18" of surface of hearth. Fixing of timbers against walls containing flues or against chimney breast or jambs to be with iron nails or holdfasts, min 4" from flue itself. No timber nearer than 9" from opening in chimney.</p>		T14.c201
		new	T6.c20
		London 1774	
		T3.c40	
		London 1774	
		T3.c37	
		London 1774	T6.c20
		T3.c36	



Sch.F cl.5	<p>No timber to be nearer than 3" to face, breast, back, side, jambs - if the brick or stonework is less than 8½" thick. No flooring, battens, grounds skirtings, linings etc, to be fixed against flue unless it is rendered or pargetted. Such render being in addition to 4" of solid fireproof structure.</p> <p>Hearth slabs to be of brick, tile, stone, slate, marble, etc, 12" min. longer than opening and 18" min. in front of opening, on stone, iron bearers or brick trimmers. (on brick fender or solid ground in lowest floor). Hearth, bedded on brick or stone, solid 9" thick below surface of hearth Chimney backs: in all rates (except lowest storey in 4th rate) to be, in lowest storey, 13" thick, from hearth to 12" above mantle, and 8½" thick in other storeys. In lowest storey of 4th rate, back to be 8½" thick, from hearth to 12" above mantle. If chimney not in party wall, then back may be 4½" less than above dimensions. In back-to-back chimney openings, thickness must be at least thickness for back of one chimney opening.</p> <p>Flues may be at any angle if size of openings in flue not less than 9" square and if proper close doors are inserted so every part can be swept by machine. If not, then min. angle = 135°, with rounded-off angles (4" min) and protected by rounded stone or iron bar.</p> <p>Close fires. Ovens, furnaces for trade, manufactures, etc, to be 6" min from party wall and 18" min from woodwork. Floor under oven to be of brick, stone, tile, slate, 2" thick, for a distance of 2'0" all round. Chimney shafts: of 4" brick or stone min, 3'0" above highest part of roof. No higher than 8'0" (except for engine chimneys) unless secured properly, of increased thickness or bonded to another chimney.</p> <p>Chimney pots. If higher than 4'0" above the brick or stonework of flue, then pot must be fixed 2'0" into brickwork.</p>	London 1774	
		T3.c40	
		T3.c37	T6.c20
		T3.c34	T6.c20
		London 1774	
		new (but also Chimney Sweepers Act 1840)	
		T3.c28	T6.c21
		T3.c39	T6.c20
		new	abandoned

	<p>Smoke pipes: no funnel or pipe conveying smoke, heated air or steam to discharge on front face of building, also no such pipes to be nearer than 14" to any timber on inside of building.</p> <p>Cutting into chimneys: only for repair, for making soot doors, or altering or inserting stove pipes or smoke jacks.</p>	<p>London 1774 L'pool 1825</p>	<p>T6.c21</p>
	<p>Sch.G cl.5 Roofs : Materials for roofing any building, projection or erection, to be of slate, tile, metal, glass, artificial stone or cement (except wood for frames and sashes).</p> <p>Rainwater pipes required to prevent water dripping on public way from roof, flat, gutter, projection, balcony, verandah and shopfront.</p>	<p>London 1774</p>	<p>T6.c20</p>
	<p>Sch.C part IV Roofs to warehouses.etc,in order to prevent curbed roofs, to be pitched no greater than 40° from horizontal, from external and party walls.</p>	<p>new</p>	<p>T6.c19</p>
	<p>Sch.E cl.5 Projections : Porticoes of churches, theatres and public buildings of Third class allowed to project in streets of 50'0" min width, with official sanction.</p> <p>Copings, parapets, cornices, piers, columns, entablatures, fascias, door and window dressings or other 'architectural decorations' could project if built of same material as wall. Balconies, verandahs, porches, porticoes, shop fronts, inclosures of areas, steps, rain water pipes all not part of external wall, could project beyond the line of fronts, if of brick, stone, tile, slate, artificial stone, metal, etc not overhanging ground of neighbour or obstructing his light and air.</p> <p>No projections, including steps, cellar doors and area inclosures allowed over public ways.</p> <p>Bow windows not to extend beyond line of fronts except as in case of porticoes above, or to overhang ground of adjoining owner or to obstruct light or air to other owner.</p>	<p>T3.c42</p>	<p>T5.c109 and T6.c19</p> <p>T5.c74 and T6.c26</p> <p>T6.c19</p> <p>T6.c26</p>

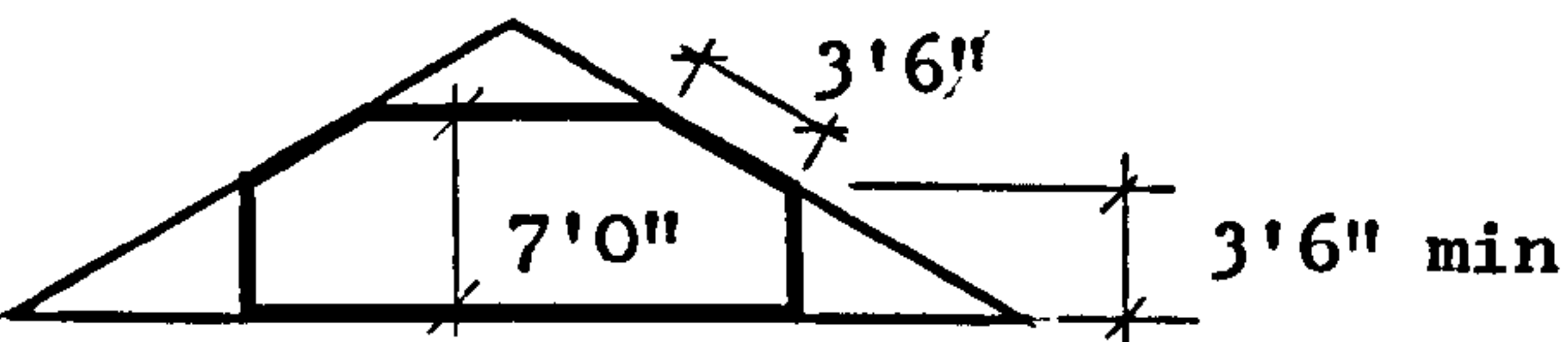
	<p>Insulated buildings (see Table 4 sheet 9 for definition) are exempt from this Act as regards projections. But any projections on them are to be at least 8'0" away from a street and at least 20'0" away from another building not in the same ownership. Shop fronts and shutters in wood: In streets under 30'0" wide, then no part of shop to be higher than 15'0" and cornice can project 13" max and no other part more than 5". In streets over 30'0" wide, then cornice can project 18" max and no other part more than 10" with no limit on height of shop front in this case. No woodwork of shop to be nearer than 4½" to centre of party wall. If at 4½" from centre then brick or stone pier or corbel 4½" wide min. required in line with party walls as high as woodwork and projecting 1" beyond face of woodwork. Every signboard of building close to public way to be 18'0" max. above street level.</p>	London 1774	T6.c26
		T3.c44	
		new	
			Defunct
Sch.C Pt. 1 cl.6	<p><b>SPACE ABOUT BUILDINGS FOR VENTILATION</b> Level of ground floor to be at least 6" above surface of earth or any paving except pavement of public way.</p>	T3.c20	(T8.c17 indirectly)
Sch.K cl.5 and 53	<p>Height of rooms: 7'0" min. (except attics), Attic rooms as below:-</p> 	T3.c21	T6.c23
	<p>Only one storey allowed in roof.</p>	T3.c22	T14.c62
Sch.K cl.5 & 53	<p>Backyards to all houses to be 100 sq. ft. min. To be inclosed, with no building thereon, except if all rooms could be lit and ventilated from a street, or from an area of 75 sq. ft. above the level of the second or third storey.</p>	T3.c23 and c17	T6.c29
Sch.H cl.5 & 51	<p><b>DRAINAGE</b> No cesspool to be built if house is within 50' of sewer, unless cesspool had itself a drain to sewer. Any cesspool under a house to be air tight.</p>	new	T6.c71-c81

	<p>Every privy to have a door for privacy.</p> <p>Soil drains - of brick, stone, tile or slate set in mortar, Air tight under building. 9" dia. min. Fall <math>\frac{1}{2}</math>" in 10'0". Drains to be built before walls reach 10'0" high.</p> <p>Drains to connect to common sewer if within 100'0" of building or to the best outlet that can be obtained.</p>	T3.c23	T6.c71-c81
		new	T5.c35

Miscellaneous Main Act clauses LIV and LV : Buildings containing dangerous businesses (from point of fire or obnoxious trade) to be 50'0" from other building and 40'0" from public way.

Schedule A Acts or parts of acts repealed by this act:-  
 1) 14 Geo III cap.78 1774. Wholly repealed except for matters related to fire engines, ladders, fire-cocks, etc in clauses 74-86 of that act.  
 2) 50 Geo III cap.75 1810. Wholly (the act which permitted the use of John's Patent Tessera for roofs.  
 3) 3 and 4 Vic.cap.85 1840. Act for the regulation of chimney sweepers and Chimneys - repealed as much as relates to chimneys in this act (M.B.A. 1844).

Schedule B Part I - listed buildings under special supervision.  
 Part II - listed buildings exempt from supervision. (generally buildings of docks and railways)

Schedule C Part I Rules for determining classes and rates and wall thicknesses.  
**FIRST CLASS:** Dwelling houses.  
**SECOND CLASS:** Warehouses, stores, granaries, brewery, distillery, manufactory, workshop, stable.  
**THIRD CLASS:** Church, chapel, college hall, hospital, theatre, public rooms etc for the 'assemblage of persons in large numbers.  
 All buildings in above classes to belong to one of certain rates - see sheets 10 & 11.

Rules for ascertaining height - from lowest floor to underside of ceiling of top storey or to underside of tie beam or to 3'0" below the level of the ridge.

Rules for ascertaining area - in squares (100 sq.ft. each) and cubic capacity for second class only.

Rules for ascertaining number of storeys - counted from foundations upwards.

Determination of lowest storey:-

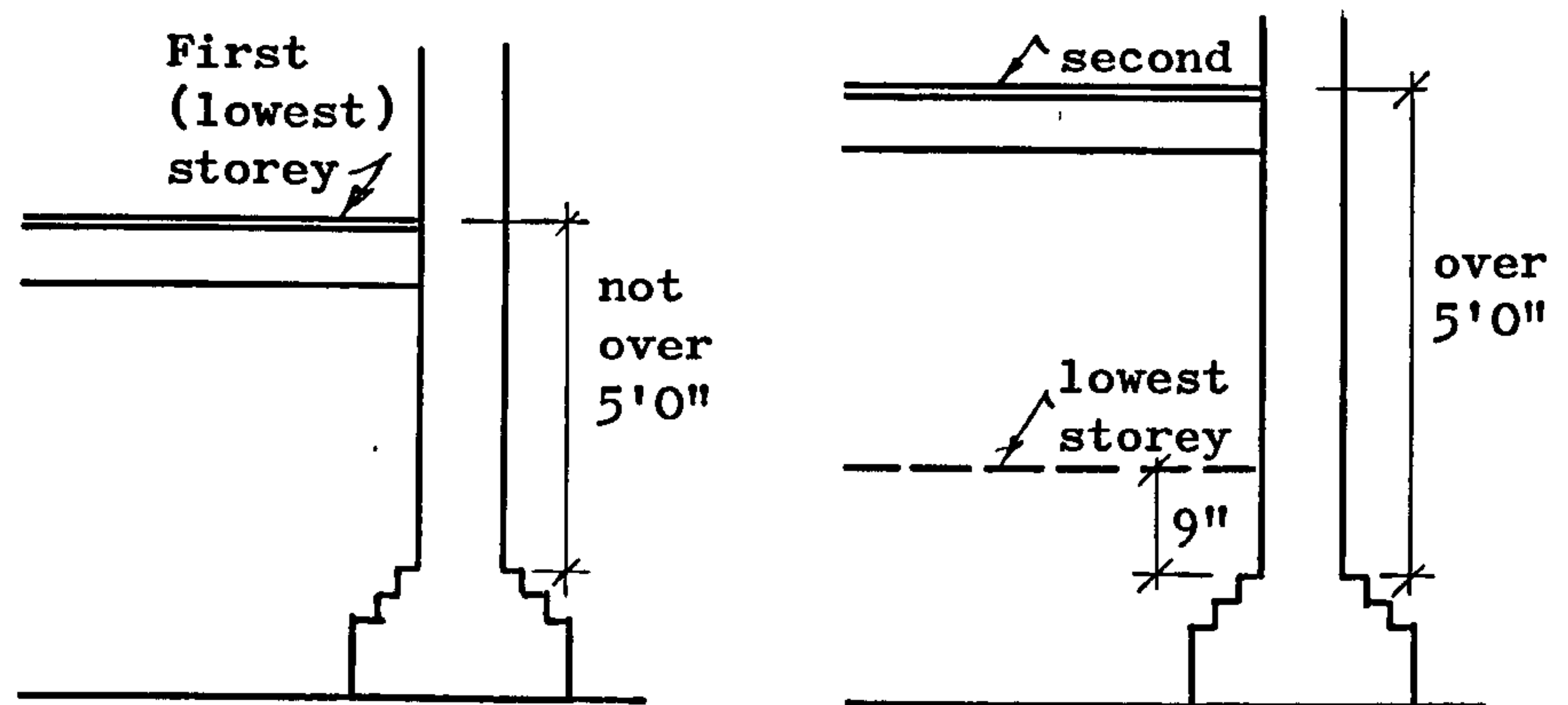

Parts II and III Rules for wall thicknesses - see sheets 10 and 11.

Part IV Rules for Second (warehouse) class - max 200,000 cu.ft. If over then to be divided by party walls to give compartments not over 200,000 cu.ft.

Part V Third or public class - if comparable in form and structure to a dwelling houses, then rates of First class to apply, or Second class if comparable to a warehouse - with additional 4" thickness to walls and footings throughout. If neither of above, then to special approval of Official Referees.

Part VI Rules for fireproof access and stairs to First and Third class :

First Class : stone stairs, with fireproof construction for support landings, passages to exterior entrance.

Third class : all floors to halls, corridors, stairs, galleries etc to be fireproof.

Part VII Associated buildings, and offices, detached or attached (except greenhouses, vineries, aviaries etc) to have walls according to the rate 'to which they would belong if they had been built separately.

Insulated buildings : First and Second class :

Every building more than one third its height away from a public street, and if not over 24'0" high, then at least 8'0" from public street;

and every building 30'0" or more from other building or ground not in same ownership - then the rules for rates and walls do not apply.

Schedule D

Part II Exterior walls demolished to height of one storey, or for a space equal to  $\frac{1}{4}$  of whole surface of exterior wall, to be rebuilt in accordance with this act.

**WALL THICKNESS SCHEDULE**  
 Metropolitan Building Act 1844  
 First class buildings

TABLE 4  
 Sheet 10

<p><b>FIRST RATE</b>                      Height = 70'0" to 85'0"                      Area = 10 to 14 squares (i.e one square = 100 sq.ft.)                      Storeys = 7 max.                      (If building is above these figures, then building to be classed as EXTRA FIRST RATE with dimension * to be 21½" and all wall above to be 17½" and dimension ** to be 17½".                      Footings : to both party and external wall:-                      width at bottom to be 17½" wider than the wall thereon and at the top to be 4" wider than the wall thereon. Height of footing above foundation to be 11".</p>	
<p><b>SECOND RATE</b>                      Height = 52'0" to 70'0"                      Area = 6 to 10 squares.                      Storeys = 6 max.                      Footings : to both party and external wall:-                      width at bottom to be 13" wider than the wall thereon and at the top to be 4" wider than the wall thereon.                      Height of footing above foundation to be 8".</p>	
<p><b>THIRD RATE</b>                      Height = 38'0" to 52'0"                      Area = 4 to 6 squares.                      Storeys - 5 max.                      Footings : as for Second rate above.</p>	
<p><b>FOURTH RATE</b>                      Height = up to 38'0"                      Area = up to 4 squares.                      Storeys = up to 4.                      Footings : at both party and external wall:-                      width at bottom to be 8½" wider than the wall thereon and at the top to be 4" wider than the wall thereon. Height of footing above foundation to be 5".</p>	

**Notes**

The top of every footing to be 3" min. below surface of ground or area adjoining and 9" below surface of lowest floor.

<p><b>FIRST RATE</b> Unlimited height.</p>	
<p><b>SECOND RATE</b> Height 44'0" to 66'0".</p>	
<p><b>THIRD RATE</b> Height 22'0" to 44'0".</p>	
<p><b>FOURTH RATE</b> Height up to 22'0".</p>	

Additional rules for enclosing walls for all buildings in First and Second Classes:-

**FIRST CLASS:** If storey is over 11'0" high, then walls to be 13" thick min.

If storey is over 15'0" high, then walls to be 17 1/2" thick min.

**SECOND CLASS:** If storey is over 9'0" high, then walls to be 13" thick min.

If over 12'0" then 17½" thick.  
If over 15'0" then 21½" thick.  
If over 18'0" then 26" thick.

The above to apply throughout at least one third of length of such wall on piers 'properly distributed' and from the top of storey to the top of the footings.

Metropolitan Building Act 1844 Additional rule for wall thicknesses:  
First class only

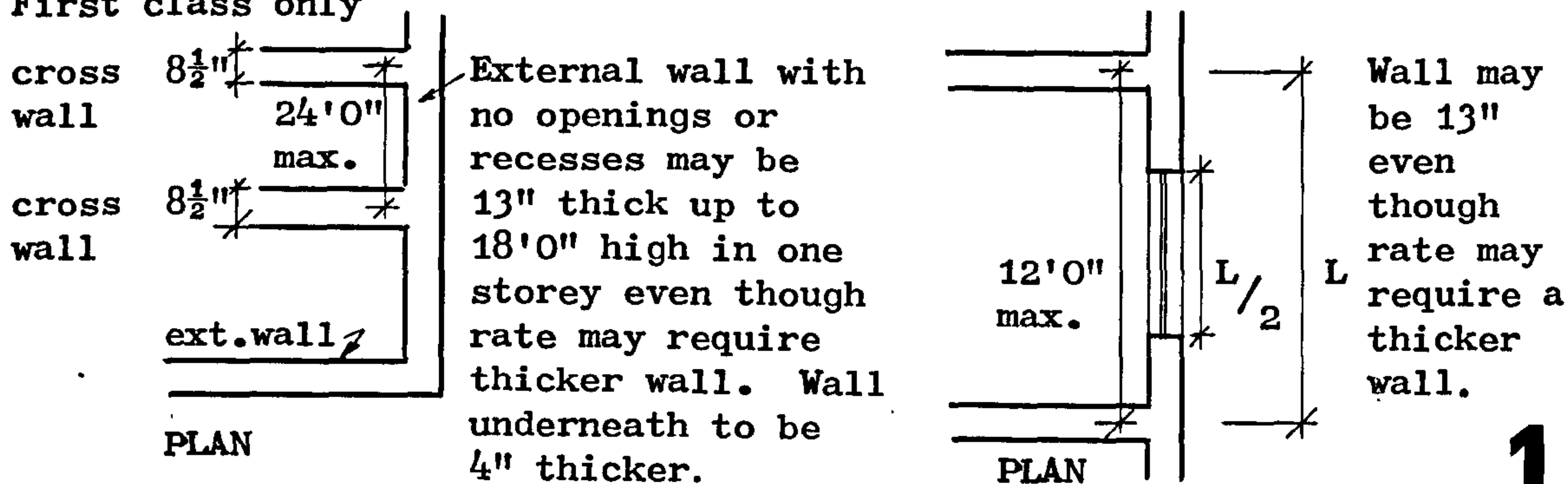

Metropolitan Building Act Amendment Bill 1847 sch.D Part II  
(see text pages 82 and 90)

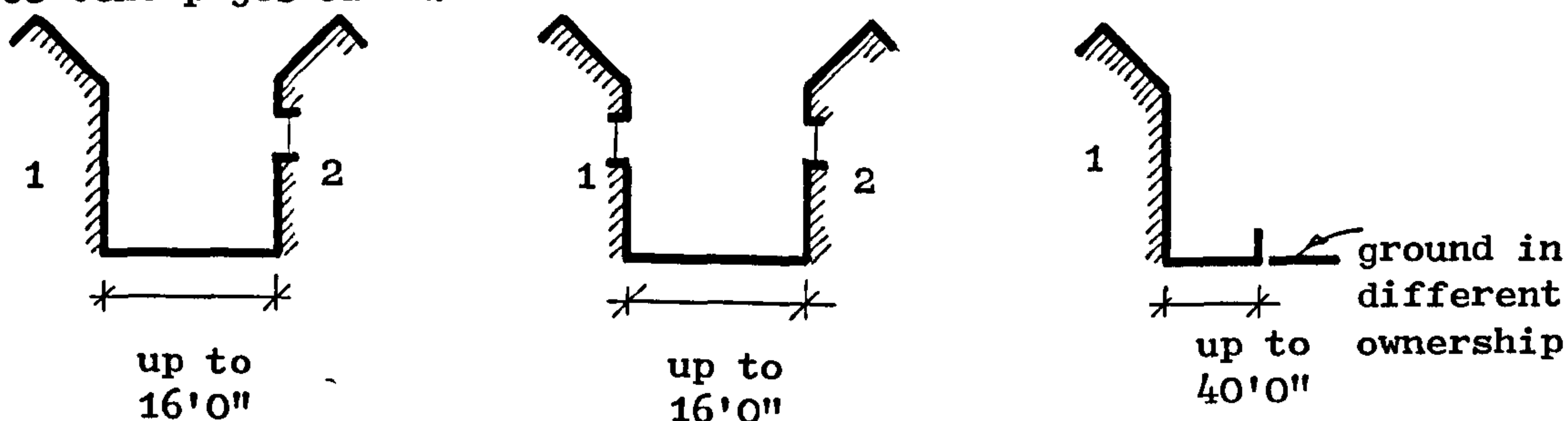

Buildings in different ownership. If opening in existing building, then no opening in opposite building.

Buildings in same ownership, but if ownership changes then openings in building 1 to be blocked.

no openings allowed in wall of building.

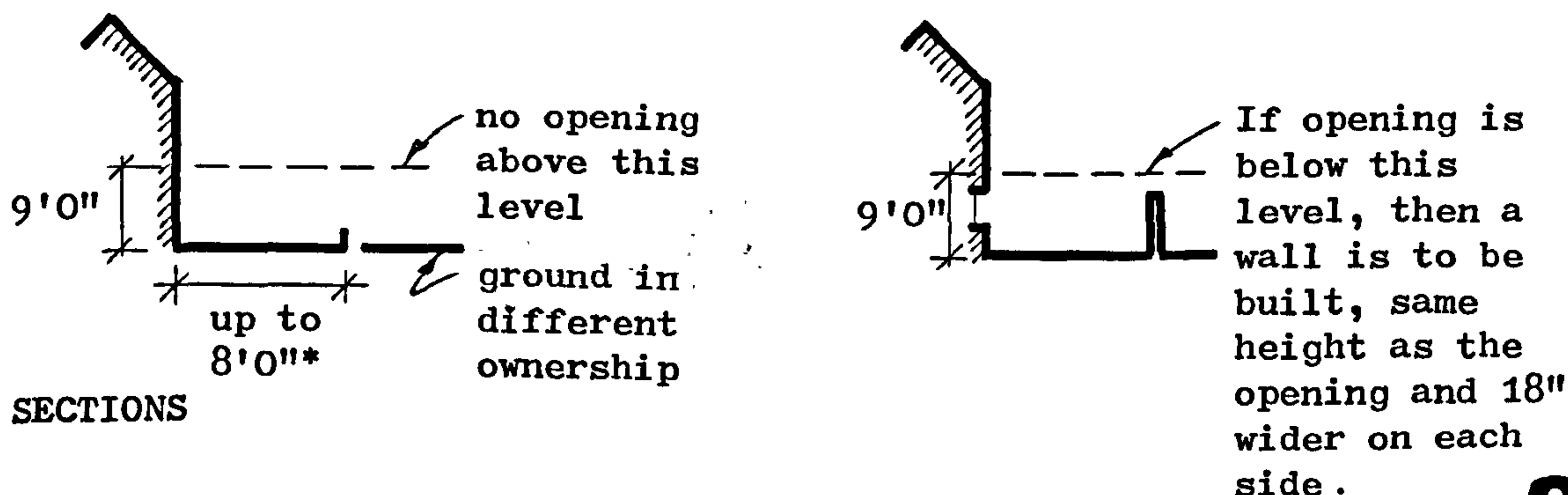



see text page: 91

SECTIONS

Cornice - as part of wall | Eaves - as part of roof

see text page: 97

Rondelet's formula example. Elevation of wall. ab & cd are return walls. On diagonal ad draw ax at a distance - 1/12 the height of ab. The shaded area is the thickness of the wall.

3
4

see text page: 96 Metropolitan Building Act Amendment Bill 1847  
Sch.D Part I

Cross wall

party wall

PLAN

$L/3$  min or  $L/6$  min

Party wall in First Class (except 4th rate) may be of thickness prescribed for next lower rate if cross wall(s) of  $8\frac{1}{2}$ " min. thickness are introduced as on diagrams to left. (Cross wall in 1st rate to be 13" where it meets a party wall of 17" upwards in thickness. No openings in cross wall in any storey over  $\frac{3}{4}$  height of that storey, and all openings in same storey not to exceed  $\frac{1}{2}$  length of cross wall.

5

Note: \* dimension may be 6'0" if building is a house not over two storeys in height.

(in diagram No.2)

Diagrams are not to scale.



### CHAPTER III

#### PROVINCIAL SOURCES, TOWN IMPROVEMENT AND PUBLIC HEALTH Pre 1840-1858

The Land Clauses Consolidation Act of 1845 (1) was the first in a series of a new type of Act which was designed to consolidate the many standard matters which constantly reappeared in an increasing number of new local acts. Joseph Hume, a Benthamite, had recommended their introduction in an effort to cheapen and simplify the tedious procedures which were necessary to obtain a local act (2). Such a collection of standard clauses could be adopted and incorporated, either totally or in part, into a local act, thereby easing the drafting and reducing debate, but it was still necessary to obtain an act in the normal way and it was not until the Local Government Act of 1858 (3) that it became possible for a town to adopt only the Clauses Act, if it wished, without entering into the costly and lengthy business of obtaining its own local act.

The concept of the Clauses Acts is important, firstly because their existence confirms the fact that there were matters common to most towns which could be standardized once and for all, and secondly because they were grouped together in various sets, based on the accumulated results of local experience, yet co-ordinated by a central body of government. In a sense therefore they are precursors of the concept of the Form and Model sets of By-laws which followed in 1858 and 1877. Though no compulsion was brought to bear on towns to adopt these measures, the need for consolidation and an increase in the effectiveness of the administrative machinery was beginning to be recognised and accepted by the Parliament. This move was further strengthened by the Government's own activities on the public health front, where their efforts to achieve a general act relating to the health of the towns occupied this same period and reached its conclusion in the first Public Health Act in 1848, a matter which is discussed further in the latter half of this chapter.

Between the first of these Clauses Acts and the main group passed in 1847 (4) there was a further measure which must be noted here in passing, since it fits into this pattern of consolidation and simplification of legislative procedures. This was the Preliminary Inquiries Act of

1846 (5), whose stated purpose was "to procure more complete and trustworthy information previous to Inquiries before either House of Parliament on application in certain cases or local acts". Notice of intended works related to "waterworks, drainage, paving, lighting, cleansing or otherwise improving any town, district or place" had to be given to the Commissioners of Her Majesty's Woods, Forests, Land Revenues, Works and Buildings and the Commissioners in turn were to appoint officers to make all the necessary inquiries. Since between 1800 and 1845 there had been nearly 400 local acts passed (6), such a measure was obviously necessary since it was intended to remove some of the anomalies which occurred between these many local acts. But the experiment failed, due to the way in which it was mishandled by the Commissioners and the Act was repealed just four years later (7).

Before considering in detail the one Clauses Act which had the most direct bearing on building, namely the Towns Improvement Clauses Act of 1847, it is necessary to outline first the earlier history and nature of private bill legislation which preceded it. It is not within the scope of this work to enter into the complex and often obscure area of the early local acts, but a reference to them is necessary here in order to establish the context for later developments. The original work of Clifford, Spencer, and the Webbs (8) is the acknowledged source for this subject and forms the basis for the following sections.

\*\*\*

### The Local Act

The majority of the legislation produced between 1745 and 1845 was in the form of private, personal or local acts, rather than in the form of additions or amendments to the general law of the land. It related to the affairs of individuals and companies or, more specifically in our case, to the affairs of a defined locality. Originating in the form of petitions to Parliament, this type of legislation had a long history, concerning itself in its earlier years with matters such as the settling of estates or the dissolution of marriages, but it was later found to be a medium capable of meeting the problems generated by the new social conditions of the age, and it was used in fact for the production of the Canal, Turnpike and Railways Acts. Such local

acts were therefore suitable for the growing urban communities who, at least before the Municipal Corporations Act of 1835, lacked any precise form of local government. Peculiar to each locality, they were generally classified as public general acts, even though they had been initiated and passed as private acts. The rudimentary powers of the Justices of the Peace had been generally sufficient to control the minor problems of communities in the 16th and 17th centuries, but the growth of towns and the consequent growth of local acts started the process by which the citizens of the towns began to supply themselves co-operatively with the means for a civilised life. "This mass of legislation represents the first efforts of a community undergoing a very rapid economic development to provide itself with local institutions suitable to its changing individual organisation" (9).

Although each town promoted a bill for its improvement on its own initiative, and although there was no model established for its guidance, it is possible to determine what Spencer refers to as the "Normal Act", that is, a set of provisions to which at any one period the local act tended to conform. Whether it was sought consciously or not is now uncertain, but it can be identified with hindsight.

The contents of this "Normal Act" were largely concerned with the convenience and safety of the users of the streets - "Eighteenth century local improvement legislation is very largely the study of man as a street-using animal" (10). Matters covered included the paving, lighting (though this <sup>was</sup> not general until after 1750), cleansing, watching (that is, policing) and the control of nuisances and obstructions in town streets. The encroachment of sheds, stalls and similar erections onto the street appears in London in 1662 (11) and is common in local acts elsewhere after about 1770 (12). Poles, steps, cellar flaps (13) - even washing lines (14), and architectural features such as penthouses, porches and projecting windows, (15) were also included. Further matters covered were the need for proper roof gutters and downpipes (16), buildings having to rise 'perpendicularly from their foundations' (17), the control of a building line (18) and the removal of entire buildings which infringed that line (19). The prevention of the discharge of smoke on the front or side of a building (20) and the general control of the type and height of chimneys was also a common feature (21). The requirements to ensure the proper emptying of privies were in most acts

after 1780, but although sewers were in use for land and later street drainage, the need for provisions for house drainage into sewers were rare before the 1830's. One early example of a move towards controlling private drains and anticipating compulsory house drainage was the Newport Local Act of 1826:

"They (the Commissioners) might also cause new private drains to be made, where they deemed it necessary, for the purpose of conveying, draining and taking away any sink, float or other refuse water, and preventing the same running over any streets, lanes, roads ... and other public places" (22).

The first local act compelling house drainage to run into a public sewer was that at Leeds in 1842 (23), being followed by Rochdale, Southampton and Manchester in 1844 (24). All these Acts forbade the building of any house until a proper drain was made to a sewer, if one were situated within 10 yards; if not, to some cesspool within the same distance. This was something of an advance, since in sanctioning this system of compulsory house and street drainage, Parliament had come to accept that the cheapest and most effectual method of removing the offensive matter from the interior of dwellings was by underground channels, but until a constant and effective means of water supply was available, the towns had to enforce this system with discretion. Indeed, although they existed on paper, the degree of effectiveness of controls for proper house drainage in actual practice was almost totally nullified by constant evasions of the acts and administrative inefficiency.

Not all local acts applied to entire districts. They often referred just to particular groups of buildings or estates - the select residential area of Kensington Square in London for example, had its own Act to ensure the construction of gutters, drains and sewers (25).

All the clauses outlined above were common to the 'Normal Act' for local improvement but, except for the clauses requiring the sewerage and channelling of new streets before dedication, they were only permissive. There was one further 'non-normal' clause which occasionally appears from about 1820 onwards, concerning the provision of fire engines, fire plugs and a fire 'police'. It was rare outside London but nevertheless its importance was realised in time for it to be included in The Towns Improvement Clauses Act in 1847 (26).

It was not unusual for one town, when considering the production of a

private bill for its own 'improvement', to look closely and possibly to directly copy the existing Act of a neighbouring town. When Manchester and Salford jointly obtained a local act for example, they were soon imitated by their neighbours in Chorlton upon Medlock, Hume and Ardwick (27). Furthermore there was a tendency for Parliament itself to operate some measure of control and uniformity on the various local bills as they were submitted to its Private Bill Committee for approval. Parliament eventually established a separate Private Bill Office, with the Lord Chairman of Committees as a permanent salaried official and it also insisted on some uniformity amongst the private bills of any given kind. It became well known in Parliament that certain clauses were essential to a particular type of Bill and in some cases Parliament would insist, by reference to its Standing Orders, that particular clauses be included. It was the slow and expensive procedure of enacting such clauses in act after act that led to their consolidation in the Clauses Acts.

Whilst the Clauses Acts enabled a town to produce its own bill incorporating such accepted and approved clauses as it felt necessary for its own situation it was of course possible for a town to adopt any general act which had been passed once the desirability of some general provision had been established, instead of once again, promoting its own Act. Such a mechanism is a further example of the move towards consolidation and simplification. It formed the basis of the Public Health Act of 1848, but as a legislative device it had a number of antecedents, of which the following are selected as examples. Gilbert's Act of 1782 (28) was one of the earliest, enabling parishes to form themselves into Unions, and in the field of town improvements there was Michael Angelo Taylor's Act of 1817 (29), which enabled various London parishes to provide themselves with basic street services and to suppress certain nuisances. Parts of this Act are still in force (30). A general Highways Act of 1814 (31) gave Surveyors the power to compel owners of properly adjoining streets to either clean the main sewers and drains, or to pay for the expense of having them cleaned; the later Highways Act of 1835 (32) incorporated provisions for carrying away surface water from streets. It became common for these street drains to be used for carrying away soil refuse from houses, a purpose for which they were not designed and which inevitably resulted in the seizure or breakdown of the system, with the well documented effects on public health. A

rarely used provision for street drains and the drainage of adjacent houses was contained in The Turnpike Act of 1823 (33), in which costs were to be apportioned between the Turnpike Trust and the persons using the drains, but it was intended for surface water only. Just bordering our field was the Lighting and Watching Act of 1837 (34), repealing an earlier Act on the same matter of 1830, in which a vestry might adopt and use to provide for the lighting and policing of streets.

It is necessary to understand that many such important regulations relating to the improvement of towns existed at quite an early date, but they had many shortcomings when it came to their practical operation, and the visible effects of their existence were painfully absent. Besides being permissive, they were frequently limited to selected parts of the town only, often failing to cover the more needy densely populated and rapidly growing areas. It was certainly exceptional for the paving of the courts and alleys of the poor to come within the Act. As one writer suggests,<sup>it was</sup> because of the legal interpretation of the words 'streets', lanes, ways, passages and places' normal in such acts (35). Therefore although these regulations existed (and that they did in fact exist is important in the context of this Thesis), they rarely had any effect on the larger part of the town and did almost nothing to prevent the spread of the appalling squalor which assisted the Cholera, and which led to the legislation of the public health movement.

\*\*\*

### Municipal Reform

The reform of local town government in the third decade of the 19th century has a direct bearing on the early history of building regulation, establishing as it did the basis for the present machinery for administrative control. It enabled building regulations to be administered at the local level and gave a focus to the constant concern which was felt between the relative extent of central and local control. As with the subject of local bill legislation, the subject has a long and complex history in its own right and the basis for this short review is based on the authoritative work of Redlich and Hirst (36).



The reform of the municipalities was a continuation of the general Reform movement and it was brought to the Statute Books in 1835, just three years after the passing of the Reform Act itself. Its origins lay partly in the decay, corruption and irregularity of the constitution of the majority of towns and partly, and more significantly, in the emergence of the new political power which the Reform Act had given the middle classes. In the growing towns this new section of society, living near its work, or indeed directly 'over the shop' began to demand higher standards of control in public order and health, seeking its practical reflection in improved paving, drainage, lighting, cleansing and policing.

Working within the principles of Jeremy Bentham, and following the pattern of the Poor Law enquiry, a Royal Commission was appointed in 1833 to report and investigate the state of the organisation of the towns. It soon decided to exclude London as a case deserving 'special treatment'. Its importance/<sup>was</sup>so great and its institution so devious and peculiar, that the case of London was set outside the general municipal reform movement and also from the general public health acts, a policy which was later seen to be also politically convenient.

The Commissioners report of 1835 was a well prepared and very thorough document. They had found many examples of abuse and had identified an almost complete breakdown in administrative efficiency, due principally to the political corruption of the ruling oligarchies which had succeeded in degrading local government for its own local political purposes. Most towns were under some simple form of control, but it was often in the form of 'ad hoc' bodies, such as the Improvement Commissioners, and they all suffered from divided responsibility, excessive waste and unnecessary expense. They were all basically incompetent to meet the increasing demands of the time and all totally unable to control properly the state of the buildings, health, safety and finances of the town.

The Report was printed in March 1835. By June, Lord John Russell had already brought in the Bill to provide for 'the regulation of municipal corporations of England and Wales' and by September the Royal Assent had been granted to the Act.

Two general points are important here, since they reflect the continual antagonism and suspicion between central and local government control which lies behind the framework on which subsequent legislation concerning building regulation was to be established.

First, the new Act did not abolish entirely the established Improvement Commissioners. It was felt that such a move would lead to the over concentration of control in one authority and could lead to further mismanagement. Parliament, and the will of the people, were against such stronghanded and single direction from above : hence the retention of the local Commissioners. It was also recognised that the machinery of local acts allowed piecemeal legislation, a more conservative and gradual technique which was preferred by the English to the alternative as exemplified by the French counterpart of elaborate total codes - and it also had the advantage of allowing the legislation to be modelled to suit the local conditions. This concept underlay the later notion of allowing towns, whilst modelling their own by-laws on the model established by central government, to modify or adapt them to suit their own local conditions. A clause in the Municipal Corporations Act did incidentally enable, though not compel, the Improvement Commissioners to be transformed to the reformed Corporation "if it shall seem to them expedient".

Secondly, the new municipal corporation, now made autonomous under the Act, was to be made the Sanitary Authority under central control when the Public Health Act was passed in 1848. It was therefore to be subject to regulations made by a central department (the General Board of Health) in much the same way as it implemented the central control of the Poor Law Commission - the first establishment of the principle of central control. The Poor Law Amendment Act of 1834 operated on the principal of central administration on a large scale and determined the Poor Law Union boundaries, not on historical or local factors, but purely on the basis of administrative convenience. The controls in the early stages were not excessive. Nevertheless they were established and, as the century developed, the range of these controls increased, permeating other areas, not least the area of building regulation. Here therefore was the start of the system of local officials having to implement regulations largely devised by others in central government. To balance the picture however one must remember that the Reform Act

itself had reflected the continuing growth of the representative power of an increasing percentage of the population to direct Parliament through its elected representatives, and furthermore, that the central government agencies producing the regulations were subordinate to that very reformed Parliament as well as ultimately to the Courts of Law.

\*\*\*

### By-laws

The literal and original meaning of the term 'by-law' is not, as is sometimes assumed, a sub-ordinate law, but, coming from the Saxon and old English word By, meaning a town, it is taken to be a law which is partial and local in its operation. Lumley (37) has further defined a by-law as "a law made with due legal obligation, by some authority less than the Sovereign or Parliament, in respect of a matter specially or impliedly referred to that authority, and not provided for by the general law of the land". The object of the by-law was to enable local communities (or organised societies) to apply legal regulations to details of a special or local character, such as the more general scope of statute law was unable to consider adequately. It facilitated the application in detail of a general statute, and yet it could not enforce or direct anything contrary to that statute nor to the law of the land in general. It was additional to the Statute law, and, as such, it had to be certain in its enactment, free from any ambiguity, general in its application and reasonable in its requirements. It was therefore, provided it conformed to these conditions, a particularly suitable device for controlling the local and detailed problems of a town, including of course, in later years, the regulation of buildings within the broader statutes of the Public Health and Local Government Acts.

Two subsequent refinements were made to the concept and operation of the by-laws in 1879 and 1899, and although they are strictly outside the time limit set by this chapter, they are relevant and may conveniently be mentioned here.

First, after the passing of the Summary Jurisdiction Act in 1879, it was possible for Justices, when hearing a case and deciding that the case was unreasonable, to exercise their own discretion (even though

there may have been a breach of the by-laws) and to dismiss the case or to impose only a nominal penalty (38).

Secondly, once a by-law was made and validated, a local authority could not dispense with its requirements in any individual case, unless the by-laws themselves gave a dispensing power. This was decided in a case in 1899, when it was ruled that a local authority had no power to sanction plans which contravened its own properly made by-laws (39).

Under the powers of the Municipal Corporations Act 1835, it was possible for towns to create by-laws "for the good government of the town". These early by-laws were not classified in any way and were a random collection of widely differing matters related to the good government of the town. The example of the Sheffield Borough By-laws of 24 July 1844 maybe quoted. They contained 79 separate regulations ranging from throwing slates off the roofs to fights in the streets, from securing flower pots on the outside of houses to the control of prostitutes and disorderly houses and from offences on the Lord's Day to painting the names of owners on coffee houses and the sides of carts. But within them are a number which touch on the matter of buildings and the following are selected, either because they are commonly found in similar by-laws elsewhere or because they reappear in The Towns Improvement Clauses Act in 1847. Leaving cellars uncovered or cellar doors unfastened (40), erecting proper fences for the safety of pedestrians passing buildings under repair (41) and the making secure of ruinous buildings (42) may seem very self evident nowadays, but they all had to be spelt out in by-laws at this early stage. Preventing water from falling from the roof, except by downpipes (43), preventing doors from opening directly outwards onto a street and preventing dangerous projections (44) were likewise all in the Sheffield By-laws and these are matters which will be considered shortly in the analysis of the Towns Improvement Clauses Act. Certain other matters, such as the rules for slaughter-houses also reappeared in the Towns Improvement Clauses Act, but other local by-laws on public behaviour reappear in The Town Police Clauses Act.

Having considered its antecedents, it is now possible to return to the Towns Improvement Clauses Act and to analyse those clauses which relate to building. The Act was entitled "An Act for Consolidating in one Act certain provisions usually contained in Act for paving, draining,

cleansing, lighting and improving Towns". It received the Royal Assent on 21 June 1847 and was greeted by The Times as being "decidedly beneficial" (45).

\*\*\*

#### Towns Improvement Clauses Act 1847

The Act, which applied to both England and Wales, could be incorporated, either in whole or in part, within a local act. Powers were given for a Surveyor and Inspector of Nuisances to be appointed (who could be the same person) (46) and also for an Officer of Health (47); both of these provisions were to be reaffirmed in the Public Health Act of the following year. (Liverpool, incidentally, had already anticipated this last requirement in its Act of the previous year, when Dr. Duncan had been appointed to the post of Medical Officer of Health (48).) The Act also allowed a survey and map to be made of the district (49), the map to have bench marks shown on it (50). This was further sign of a more methodical approach to the problem of improving a town by actually attempting to accurately survey and plot the state of affairs, rather than relying on rumour and local pressures, and it was a requirement which also reappeared in the Public Health Act - but curiously without mentioning the bench-mark provision (51).

Table 5 shows in summary form those clauses in the Towns Improvement Clauses Act which have a bearing on building design and construction. Though the Act was not principally directed towards building regulation, it inevitably impinged on building matters when seen in relation to the external improvement of the town. The clauses selected have been grouped in accordance with the pattern established earlier in this work, grouping them into main subject headings.

#### Cellars (Table 5, sheet 1)

Cellars for habitation maintained the standards relating to room heights and the prevention of cellars in courts, that were seen earlier in the Liverpool Act of 1842 and which were copied by Wallasey in 1845 and Southport in 1846 (52). Such regulations did not, however, appear in the 'Normal Act' discussed earlier, the problem of cellar dwellings being

only recognised as a health hazard in the early 19th century - being highlighted by the Health of Towns Report of 1840 - and not seen as a area of public concern in the time of the Improvement Acts of the late 18th century. In the Towns Improvement Clauses Act we follow this matter of cellars, en route, as it were, towards the Public Health Act of 1848. We have noted in the preceding chapter (page 101) a parallel move in London, taking cellars from the 1844 Building Act across to the Metropolis Local Management Act of 1855.

### Streets (Table 5, sheet 1)

Streets were naturally one of the principal areas of the Act. The widths set here maintained the standards of Lord Normanby's Bill of May 1841, reflecting perhaps a certain consistency on the part of the drafters of the legislation. Liverpool had now also fallen into line, its Act of 1846 bringing its street widths up to 30'0" and 24'0" and, just after the Towns Improvement Clauses Act was passed, Bristol also conformed and included the same dimensions in its new Act. Bristol also included the provision of the London Act of 1844 which related the height of buildings and the width of streets. The control of street width was also not a feature of the 'Normal Act' and without established precedents, when it came to setting street widths for health reasons, towns frequently set their own standards with little apparent consistency: Nottingham for example had 36'0" for streets and 20'0" for alleys (53), Birkenhead had 24'0" and 18'0" respectively (54). Almost as a recognition of this local prerogative, the standards in The Towns Improvement Clauses Act were only offered as a guide and the Commissioners in the towns could still set their own widths if they preferred. This must have been a jealously guarded right, for, by the Public Health Act of the following year, all references to dimensions for street widths had been removed.

Building or Improvement Lines were part of the 'Normal Act'. The Dover Local Act of 1810 for example (55) allowed building both beyond the existing line of foundations, at the Commissioner's discretion, so as to be 'one line with adjoining buildings' and also, on the reconstruction of a street, the Commissioners could order a building to be set back to the 'repair line of the street'.

The paving of streets had had a long history in the 'Normal Act' (56).

Originally each property owner was required to repair the street in front of his property, up to the centre line of the street, but later the Improvement Commissioners undertook this work, charging a proportion of the cost to the adjacent property owners. As the Webbs state in their study (57), the Improvement Commissioners had done much work before 1835 which was not to be despised - the paving of Portsmouth in 1769, for example, had saved it from "intermittent fever" and their work on drainage at the nearby town of Kilsea in 1793 had subdued the "agueish disposition" (58). Standards for paving were sometimes laid down in the Local Improvement Act itself, as at Devonport in 1781 (59), and this setting of such a standard in principle was taken through into clause 69 of the Public Health Act of 1848. But, of course, these attempts at paving were only a small part of the problem:

Who could pave properly among the "three rows of house, of which the lowest rise directly out of the river, one above the other on the steep bank of the Irk?" From this filthy stream in Manchester in dry weather "bubbles of miasmatic gas constantly arise and give forth a stench unendurable even on the bridge, 40 to 50 feet above the surface of the stream" (60).

The control of projections into streets, originally for the safety of passers-by along the thoroughfare, though also with implications for the spread of fire and blocking out of light and air, had also had a long history within the 'Normal Act'. The prevention of doors opening outwards onto the streets was a common clause within this area, but it is interesting to note the proviso included in clause 71 of the Towns Improvement Clauses Act for the doors of public buildings still to open outwards, allowing for the safer exit of the public in an emergency, a requirement which the increasing number of fire tragedies in theatres had brought to the public's attention (61).

Proper covers or flaps to cellars had also been a feature of the 'Normal Act'. We read that

"a considerable proportion of the London poor hid themselves at nightfall in cellars. These inhabitant of cellars were permitted to enjoy and utilise a modicum of daylight that came to their darksome rooms from the streets, and even to keep the flaps of their street doors thrown back by day, provided they closed the flaps at nightfall" (62).

The protection of the cellar opening by a fence or rail was, for some unknown reason, included in The Town Police Clauses Act (63). The provision of public street lighting was very uncommon before 1750, it

being accepted as a private service to be undertaken by each householder. The Towns Improvement Clauses Act included a provision for the Improvement Commissioners to contract out for this service, and this facility was taken on into the Public Health Amendment Act of 1849.

#### Structure (Table 5, sheet 1)

The structure of walls was limited in the Towns Improvement Clauses Act to only the provision for the carrying up of the party walls to a height of 12" above the slope of the roof. This requirement was not in the 'Normal Act', but its precedent with the same dimension was again Lord Normanby's Bill of 1841 and the Bristol Act of 1788. London, it will be recalled, was still maintaining its old standard of 18" for this regulation, but it was to be later reduced to 15" in their Act of 1855 - perhaps as the average, being a compromise between the Metropolitan 18" and the Provincial 12". Included also under this topic was the requirement for roofing materials to be incombustible - again a long standing regulation. At Calais for example, in 1548 thatch and straw were banned - "to the great danger of fire, which God defend" and by 1552, all roofs there had to be of tile or slate (64).

#### Ventilation and Space about buildings (Table 5, sheet 2)

These subjects were in The Towns Improvement Clauses Act, limited to just one clause. At first sight it seems rather too particular and therefore somewhat incongruous, referring as it does just to the ventilation of public buildings. It appears to be a rather hasty insertion and comes almost certainly as a direct result of the 26th recommendation of the Report of the Royal Commission on the State of Large Towns and Populous Districts of 1844-55 : "we therefore recommend that measures be adopted for promoting a proper system of ventilation in all edifices for public assemblage and resort, especially those for the education of youth". There is little else on internal ventilation before 1858, though it is occasionally found in some provincial acts, such as that of Nottingham in 1845 (65) where no room could be used as a workshop or bedroom without a fireplace or proper ventilation.

#### Drainage (Table 5, sheet 2)

The provisions for drainage of surface water in public sewers, under the



control of Commissioners of Sewers, had possibly the longest history, certainly as far back as the time of Henry VI (66). The Commissioners' duties had included the cleaning of streams and rivers, maintaining the sea defences and the removal of street water. From the middle of the 17th century, the increase in house building in towns had, simply for the convenience of the public, led to the construction of forms of underground sewers for the disposal of rainwater but, being in close proximity to the houses, they naturally became a ready means of disposing of liquid and solid refuse and quickly became polluted (67). What powers there were in local acts only related to surface drainage, not to house drainage or sewerage (68). The early Improvement Acts of Liverpool and Bristol in fact contained no provision at all for drainage.

The matter of house drainage has been mentioned in the earlier discussion of the 'Normal Act'. The concept of house drainage did not really appear until the 1830's - the stagnant cesspool, often under the floor of the house, was very common. Some towns actually prohibited house drains from connecting with the sewers since they were held, quite rightly to be for surface water only. In some areas, permission to connect was: "commonly deemed the concession of a privilege, subject to regulations and separate proceedings, with attendant expenses, tending to restrict the use of sewers for these most important purposes, or to confine this advantage to the wealthy" (69).

The reason for this exclusiveness would appear to be the introduction of the water closet around 1810 - and then, of course, only in the more wealthy houses. It would have overloaded the capacity of the existing sewers if freely adopted, and it also needed that rare commodity, an efficient supply of water. Its adoption was at first slow, but its advantages in promoting domestic cleanliness became gradually appreciated and after 1830, its progress became rapid and remarkable. The w.c.'s were originally made to discharge into cesspools, but this large addition to their contents rendered it necessary to introduce overflow drains running from the cesspools into the street sewers (70).

There were two clauses in the Towns Improvement Clauses Act which referred to drainage construction, one controlling the building over sewers and the other the need for proper traps 'or other coverings or means of ventilation so as to prevent stench' - this need for traps having again been anticipated in the Liverpool Act of the year before (71).

Powers to provide privies, as included in the Towns Improvement Clauses

Act, can be traced back through the Local Acts of Burnley and Newcastle of 1846 (72) to Nottingham of 1845 (73) which had stipulated a separate privy for each house, to Birkenhead 1843 (74) and Leeds 1840 (75) where, under clause 190, the Council had power to compel a proper privy for each new house. But the implementation of these powers was, as we have seen with most of the legislation of this time, largely of a permissive nature and was rarely enforced. In the case of Leeds for example, Hole noted in 1866 that no one there appeared ever to have been sued for the breach of that regulation (76).

The provision of roof drainage was an established feature of the 'Normal Act' as described earlier, and can be traced back to London in 1662 and Liverpool in 1786 (77). The reference to fire-plugs has also been mentioned earlier. Both these matters appear in the Towns Improvement Clauses Act. Rather surprisingly however, the prohibition of chimneys and funnels on the face of buildings did not appear in the Act although it appears in a number of earlier local acts such as Liverpool 1825 (78), Chorlton upon Medlock 1832 (79), London 1844 (80) and Bristol in 1788 (81). The requirement for factories to 'consume their own smoke' was however included - a precedent being an early by-law under the Macclesfield Local Act of 1825 (82) where the type and height of chimneys, flues and furnaces were controlled in such a manner as "most effectively to destroy and consume their own smoke".

This completes the survey of the more significant clauses in the Towns Improvement Clauses Act, but before turning to the continuation of the public health movement it is necessary to outline briefly here some of the other Acts and controls that were in existence immediately prior to the Public Health Act. London has been discussed in Chapter II, the 'Normal' local improvement act and the Towns Improvement Clauses Act have occupied this Chapter so far. Liverpool, Bristol and certain other towns had Acts passed around this period which also contain matters related to buildings.

\*\*\*

Liverpool, in anticipation of the moves in Parliament towards a general Public Health Act, had already decided to pre-empt the situation by introducing its own local measure, the Liverpool Sanitary Act, on June

26, 1846 (83). It reinforced the regulations of the earlier Act of 1842, and as B.D.White observes (84), it closely followed the recommendations made by Holmes and Duncan to the Royal Commission enquiry into the State of Large Towns and Populous Districts in 1844. Holmes' recommendations had included the proper construction of buildings to ensure their stability, adequate widths for public thoroughfares to ensure the through ventilation of courts and alleys, adequate sewers for draining the streets and private drains for houses. The Act authorized the connection of house drains to public sewers and, as noted earlier, the use of trapped gullies. Its street widths were adjusted to 30'0", but its courts were set at 15'0". There was an acknowledgement of the relationship between the height of houses and the width of streets in its requirement for an extra one foot in the width of a court for every house which exceeded the basic number of eight. Heights of houses were limited to two storeys and were not to exceed 30'0", the houses had to be built to proper levels and had to be not less than 6" above the level of the adjoining foot path or road. Cellars had a minimum height of 7'0", as in the London Act of 1844, but whereas in London the level of the cellar floor had to be 3'0" or more below the level of the road, the cellar in Liverpool had to have its ceiling 4'0" above the level of the road (an increase of 2'0" over the 1842 Act). Minimum room heights, other than in cellars, were set at 8'0" and attics were given a more complicated set of room height controls. Only one attic storey was allowed in a house and it only came under the control of this clause if it was in a house with three floors above the basement and had part of its attic room higher than the level of the spring of the roof. It is shown in diagrammatic form on Table 5, sheet 3)

Bristol's new Building and Improvement Act Amendment Act of 1847 (85) was passed just eleven days after the Towns Improvement Clauses Act. It was largely in line with the scope of the London regulations, particularly with regard to chimneys, party walls and projections, though with local variations, such as a separate schedule for stone walls (as opposed to brick) for its wall thickness regulations. In its street widths it followed Normanby's Bill of 1841, though it was unusual in setting a maximum standard as well - 50'0" in the case of a street and 30'0" in the case of a footway. The relationship between street width and height of buildings followed the London example, and it also

required every footway (i.e court) to have an entrance of the full width and open from the ground upwards.

It is worth noting briefly here the inclusion of other regulation matters that have appeared in our earlier discussion and which were being perpetuated in a number of other local acts passed at around this same period. The sizes of rooms, for example, were under control in Liverpool, Birkenhead and Wallasey (86) and in Nottingham in 1845 (87) it was determined that every house should have three bedrooms of a fixed size. The size of windows was included in Liverpool and Birkenhead (88) and the ban on houses in close courts was maintained in Birkenhead 1843 and Manchester in 1845. Back-to-back houses were prevented, in theory at least in Nottingham in 1845 (89), where no house was to adjoin another on more than two sides and the same intention was sought by the Manchester Police Act of 1844, where each new house was required to have a privy and an ashpit in a yard behind each house (90). Nottingham also controlled building heights by requiring a building to be no higher than the width of the street (91) and the height of rooms were controlled in Birkenhead and Wallasey (92) on the lines set by the Liverpool Act.

\*\*\*

#### The Health of Towns Bills and the Public Health Act 1845-1848

This second half of the chapter continues with the account of the public health movement from the point at which we left it at the end of Chapter 1, namely with the Report of the Royal Commission on the state of Large Towns and Populous Districts. The Report was received in February 1845 and Lord Normanby immediately introduced a petition in the Lords calling for the adoption of its recommendations (93). The Health of Towns Bill received its first reading in July (94). It took the recommendations of the Report - which largely restated the earlier conclusions of Chadwick - but which introduced the concept of the Crown being empowered to supervise and inspect the sanitary laws of the larger towns; the local authority, as a single body, being given responsibility for the paving, draining and cleansing. The Home Office was to become the central controlling department, the Home Secretary appointing inspectors for local administration and local enquiries.

The central authority would now have powers to deal with negligent local authorities. The Bill therefore marks a further step in the process of centralisation and rationalization of the health controls - the controls which were to bring further building regulations in its wake. Needless to say, many of the more jealous local authorities were hostile and suspicious, but the support of the popular Health of Towns Association was to prove of value in the face of such opposition. The detailed account of the successive Public Health Bills is involved and cannot be fully described here. Suffice it to say, by 1846 the Bill had been lost, as Peel's Conservative government suffered internal dissension following the effects of the Corn Law crisis - the final result being Peel's resignation in June 1846.

The year did however see the passing of the hastily prepared Nuisance Removal Act (95), rushed through in the face of another threatened Cholera outbreak. This had a side effect on the latter pattern of local rural administration since it entrusted its duties to the Board of Guardians, and the Poor Law Authority was recognised for the first time as the rural sanitary authority. Its district, the Poor Law Union, foreshadowed the later rural sanitary districts to whom rural by-laws were to be entrusted towards the end of the century.

The return of the Whigs to power in 1846 brought Lord John Russell to the Premiership and the dynamic Lord Morpeth to the Commission of Woods and Forests, from where he started to organise a stronger Parliamentary movement towards sanitary reform. But there were obstacles ahead, not only in the form of the ambitions and abuses of the representatives of the towns, but also in the limitations to more extensive powers which were required but which were restrained by the Municipal Corporation Act of 1835. The reformers now looked to the Poor Law Commission as a model, rather than to the Home Office as the central agent. The 'Leeds Intelligencer' had suggested a Ministry of Health in December 1846 (96), but Lord Morpeth had proposed instead an organisation similar to the Poor Law Board. This was to be a body of Commissioners, of equal authority with a Minister as an ordinary member, not a department under a minister's control with direct authority and responsibility to Parliament.

The Bill as it appeared on 30 March 1847 was elaborate, containing larger

powers of reform. It defined boundaries and set up a Public Health authority for each district. In corporate towns, the Town Council would be the appropriate authority; in non-corporate towns, local commissioners would be appointed, partly by the Crown, and partly by the ratepayers. They in turn would appoint surveyors and inspectors to look after the streets, drainage, building regulations, smoke, slaughterhouses, cemeteries and to build gas and water works.

Opposition from Lincoln was a politically based attack. He now criticised the Bill for giving too much power to the central authority and he felt that town councils, being basically political in character, could not be given the control of the larger areas with safety. Coupled with this, there was opposition from the water, gas and burial companies. In an effort to save the Bill, Morpeth conceded a limitation of the measure to Corporate towns - and to non-corporate towns on petition only - by allowing the election of all the Commissioners by the ratepayers only, and the exclusion of London from the provisions of the measure. But with a combination of bad drafting and mounting political pressure, the Bill was again abandoned in July 1847. Its return was promised for after Christmas, but no decision about the inclusion or exclusion of London was reached (97).

On February 10, 1848, Lord Morpeth introduced his revised Bill (98). It was a modified version of the earlier Bill. London was to be excluded <sup>and</sup> administrative boundaries were not to be enlarged to coincide or relate to the areas of natural drainage as had previously been proposed. Local Boards could compel house owners to provide drains and a water supply, but the other powers were only permissive and included provisions to alter sewers, pave streets, alter new buildings and appoint Medical Officers of Health.

The Bill was to operate on the basis of the old Poor Law Commission, a decision that was viewed by The Town Councils with disfavour. The continuation of the idea of a form of central control and authority was still viewed with apprehension. Yet there was a growing body of support for this area of reform. Following the representation by various local authorities, Morpeth made further concessions, allowing the Town Clerk of Manchester and Mr Beckett, Member of Parliament for Leeds, an opportunity to discuss the remodelling of the Bill with the

parliamentary draftsmen. The main result of this was the disappearance of the general superintending power of the new central department (99). On this basis the Bill received the Royal Assent on 31 August 1848 (100).

The Act was permissive only - "this Act may from time to time be applied in manner hereinafter provided to any part of England or Wales" - excluding London. Any town could adopt the Act if it wished, but there was more bite in the provision which enabled the central Board of Health to force the Act on the towns where the death rate was over 23 per 1,000, or where 10% of the inhabitants requested it. The General Board of Health was set upon the lines of the Poor Law Commission, with Lord Morpeth as President, assisted by Lord Ashley and Edwin Chadwick. As a concession to the fear of the 'local autonomists', it was set up for five years only. Local Boards of Health were created - in the municipal Boroughs it was the Town Council itself, elsewhere it was to be a special board, elected by the ratepayers, on the lines of the Board of Guardians under the Poor Law.

The Act provided the first almost complete code of Public Health. It could be adopted anywhere without the expense of obtaining a local act - it was in fact to be in some 200 towns within the first six years of the operation of the General Board of Health, saving about £2,000 for the cost of each local act (101). Some towns, however, continued to defy the Act, promoting bills of their own. Birmingham for example, spent £10,000 on its own local act. As under the Municipal Corporation Act of 1835, local boards could make by-laws.

Although it could be forced on certain towns or districts, the Central Board could not actually compel the town to take any effective action, since it had no legal powers of inspection. A town could defy the Board (102), but nevertheless, the supervisory powers of the Board, acting through its inspectors, could have some effect (103). It suffered from having its pattern based on the Poor Law Amendment Act of 1834 rather than the Municipal Corporation Act of 1835, since votes were not allowed to each householder but were allocated on a classification based on wealth. The Clerk, Surveyor and Inspector of Nuisances were all appointed - and subject to dismissal - by the local Board itself, except that the removal of the Surveyor had also to be approved by the General Board - a rule later abolished in 1858.

Similarly, financial control of its affairs, by auditors appointed again by the Local Board, was somewhat unwise. This was to be partially repealed in 1858 and totally in 1875. Fundamentally there was therefore a split in responsibilities, the local authorities operating the Public Health Act under central control, yet undertaking other activities under the full local autonomy established by the Municipal Corporations Act of 1835. That certain by-laws and regulations could be made under both statutes did little to ease the inevitable problems of conflict and divided loyalties - to the eventual confusion and annoyance of the public itself.

\*\*\*

#### The Public Health Act 1848

Being principally concerned with the fundamentals of health control in the form of water supply, sewerage, drainage, cleansing and paving towns, the Act itself did not specifically cover building construction. Its principal importance to us is its administrative framework and its formation as the principal legislative measure, together with its counterpart in the Local Government Act ten years later, under which building by-laws were to be introduced. It did however allow the control of streets and buildings but only at the absolute discretion of the local authority. There were therefore certain matters within it which do concern buildings, and these are selected and briefly discussed in this section.

Following the 24th and 25th recommendations of the Second Report of the Royal Commission on the State of Large Towns and Populous Districts, 1845, the regulations for habitable cellars were extended to the whole country, as was the provision of a privy for each house. Precedents lay in the Acts of London and Liverpool, as well as in the Towns Improvement Clauses Act, but they could now be obtained by simply adopting the Health Act, rather than by seeking a new local act. Cellars, under clause 67, could not be inhabited unless they were at least 7'0" high (the standard of preceding legislation) and unless 3'0" of that height was above street level. This was closer to the Liverpool standard of 4'0", than the London regulation (see earlier page 72). The open area along the entire frontage, 2'6" wide and 6"



below the level of the cellar floor was, however, closer to the London requirements of 1844. The Public Health Act also maintained the need for a fireplace and external window in the cellar, the window being of 9 sq.ft. clear of the sash frames and capable of being opened. The amount of opening area was not now specified and left to the Surveyor's discretion. The Act added the need for a w.c., privy or ashpit for the use of the cellar dwelling and a further modification to allow an inner or back room, when let in conjunction with the front room, to have a window of 4 sq.ft. in area. The open 'area' was required to be in front of the cellar window, but no specific dimensions were included to control its length, as was stipulated in London. No iron grating over the area was allowed, the steps down, which had to be at least 6" away from the wall of the house, could not be over, across or opposite the external window, nor could the access to the upper front entrance door be across the cellar window.

Clause 51 stated that it was not lawful to erect or rebuild a house without a w.c., privy or ashpit with proper doors and coverings; and the next clause called for separate facilities for both sexes in factories with over 20 employees. This was stronger than the London requirement, which did not actually say that each house had to have a w.c., privy or ashpit, although they were mentioned in connection with drainage under Schedule H of the 1844 Act. The requirement for doors was in the London Act however. Clause 53 required notice to be given to the Local Board of the intention to build, together with the level of cellars and the position and construction of privies and cesspools, and work was not to be started on them until they had received the Board's approval. This was the clause, small in its way, which, together with clause 72 (see below) was to be repealed in 1858 to broaden the scope of control to allow further by-laws to be made for streets and buildings.

Clauses 43 to 48 covered the powers for making or altering sewers by the Local Board, and No 49 directly referred to house drains. No house could be erected or rebuilt, or occupied when newly built or rebuilt, unless it had covered drains connecting to the sea, or to a sewer of the local Board, if within 100'0", or to a covered cesspool as directed by the Local Board. All these had featured in the Towns Improvement Clauses Act of the previous year and the 100'0" dimension had come

through from the Metropolitan Building Act of 1844 (Schedule H).

The 23rd recommendation of the Royal Commission concerned the need for the through ventilation of courts and alleys, a measure which had featured in the Liverpool and London Acts. There was obviously a need for legislation on this matter. J.C.Hall for example, writing in 1848 had recommended the following clause for the new Health Bill : "the providing the means whereby the proper ventilation of all houses may be effected, and the creation of a power which shall enable the Inspector of Nuisances to remove all houses which block up the ends of lanes or courts, and prevent a free current of air from passing through them" (104). There was in the event no direct reference to this in the Public Health Act, but clause 72 required notice to be given to the Local Board before new streets were laid out, in order to fix their level and their width. No dimensions were given, but the definition of streets included courts, alleys and passages in its terms, and one assumes that these powers were considered to be sufficient. This area of control was to reappear however, in more definite terms, in the 1858 Form of By-laws, following the repeal of this Clause 72 and the substitution of a wider range of controls through section 34 of the Local Government Act of 1858.

Clause 115 allowed the formation of by-laws. Two small points to note in conclusion. First, the definition of a house, which now included schools, factories and other buildings in which more than 20 persons were employed at one time and secondly, clause 151, which reminds us that the antique window tax was still in force in 1848 - although it had only three more years to run. This clause allowed a person who had to make a new external window in his cellar, in order to comply with the new Health Act, to make such a window and yet not be subject to window tax if that extra window increased his total number of windows beyond the basic seven which were allowed free of tax.

\*\*\*

#### Local Government Act 1858

A second major outbreak of Cholera occurred in 1849, the year after the passing of the Public Health Act. A hastily contrived Cholera Bill

was drawn up in anticipation in 1848, but its operation, under the title of the Nuisances Removal and Diseases Prevention Act (105) was virtually useless since, although the General Board of Health were granted wide powers under it, they had no power to enforce its regulations. What controls there were remained with the many and diverse Poor Law Guardians. Two points of significance may be noted here which can be seen to have a bearing on the changing legislative attitudes. First, the entrusting of these duties to the Poor Law Guardians confirmed the Poor Law Union districts and, as noted previously, implied the future rural sanitary districts and secondly, no time limit was set on the operation of the Act. The earlier Nuisances Removal Act of 1846 (106) had set a limit of two years, but this new Act had no such limitation and therefore reflected a growing confidence in these forms of control. The 1849 cholera epidemic also served to increase further the concern of the public over matters of health and resulted in a number of detailed reports from many of the new Medical Officers of Health throughout the country in which the relationship between disease and the physical environment was constantly stressed. 1849 was also the year of John Snow's work which proved that these diseases were water borne, rather than air borne, and were transferred from the mouth to the intestine - but it was some years before his proof was widely accepted.

The General Board of Health was dissolved six years after its establishment, although it staggered on in somewhat different guise until 1858. Its collapse was probably inevitable, considering its severely limited powers, and the lack of a Minister with effective control and direct responsibility to Parliament. The law that it was trying to enforce through the Public Health Act was "merely an empowering law and no place on which the powers might be compulsorily conferred would thereby be made any likelier than before to use the powers" (107). In attempting to apply the Act to a town with a high death rate, it appeared to many to be the resented interference by distant central government officials in the affairs of the local community. This was still a real and constant fear and it was encouraged by the romantic and extravagant writings of Toulmin Smith and his band of supporters, campaigning for the return to the Common Law of an indefinite and misty period of Anglo-Saxon England. The Board had no power to appoint inspectors, and it thereby met the direct opposition of the Engineers, another constant

source of antagonism which was frequently strained to its limits. Chadwick's strongly held views on the merits of narrow drainage pipes over the traditional large brick sewer was but one example of this stress. Besides the towns and the Engineers, the third area of conflict lay with the medical profession, which was only softened after 1850 by the appointment of the old campaigner and respected authority of Southwood Smith to the Board. And as if to prove the general inefficiency and perverseness of the Board, Cholera struck for a third time in September 1853. It was ironical that it should have selected Newcastle upon Tyne for its initial target since, in its municipal wisdom, Newcastle had decided to opt out of the Public Health Act. With half its families living in shared rooms - some rooms containing as many as 25 persons and with two-thirds of its population denied access to a private privy (108), it was a ready target. In general however, the Cholera of 1853 was not so severe as the earlier visitations and this may well have been partly the result of the Public Health legislation. Certainly by that date, 120 towns had applied to have the Act implemented and a further 94 had had the Act imposed by Orders in Council (109).

The cholera epidemic served as a further encouragement to a new round of health legislation. 1855 was the key year for the production of new legislation. The Diseases Prevention Act (110) and the Consolidated Nuisances Removal Act (111), whilst not directly relating to building, did further extend the general administrative powers of the Local Boards and Town Councils - giving limited powers of entry for health reasons for the first time, for example. The Metropolitan Building Act of 1855 (112) and the Metropolis Local Management Act of the same year (113) belong to the next chapter. It was the latter Act incidentally which created the Metropolitan Board of Works, the precursor of the London County Council and Greater London Council and which brought London more in line with the public health controls already operating in the rest of the country. It allowed vestries to appoint Medical Officers of Health and caused the matters of streets, drainage and cellars to move from The Building Act to the Management Act. An attempt to complete this round of legislation in 1855 with a new Public Health Act was unsuccessful, as it was again in 1856 and 1857. The Board of Health, dissolved in 1854 with Chadwick being pensioned off, was reconstituted the same year in a different form with a President who had a seat in Parliament (114) and its powers and duties remained largely intact.

It continued for one year, and then just remained alive through a series of annual Continuation Acts (the first of which (115) brought the powerful figure of John Simon to the position of Medical Officer) until it was finally extinguished on 1 September 1858. Its ghost was to be divided, one half reappearing in the Privy Council and the other half in the Home Office, under the respective powers of the two Acts of 1858, the Public Health Amendment Act (116) and the Local Government Act (117).

The new legislation of 1858 which related to health was all concerned with an interrelated topic, yet it was still largely treated as a succession of independent and experimental measures, each moving carefully and painfully forward, but with little overall control. No doubt the fear of appearing to be too heavy handed with a concentrated package of legislation was politically realistic, with Parliament reflecting subconsciously the English temperament in these matters, yet the result for posterity was the familiar pattern of a number of various and unrelated controls, a fragmentation which is reflected in the scattered location of the legislative controls affecting building today.

The Local Government Bill was introduced in the Commons on 23 April 1858 (118). In the debate on the second reading a week later, Mr Adderley said that it was not a new measure, nor was it on a new principle (119) - it was merely an amendment to the Public Health Act of 1848, and had been drawn up with that intention and it should therefore be read in conjunction with the earlier Act. The Act divided the powers of the General Board of Health, as we have noted earlier. To the Home Office went the matters of sanctions, appeals and provisional orders, and, within the Home Office, the establishment of a Local Government Act Office, to execute the Act, give superintendance and assistance to the Local Boards and to take under its control the business of approving by-laws. To the Privy Council went the medical and supervisory functions - together with John Simon. The Act which gave these powers to the Privy Council had originally a life of only one year, such was the outward sign of the internal antagonism felt over this proposal (120). According to Simon (121), it was the intervention of the Prince Consort, always a keensupporter of sanitary reform, that led to the overcoming of this curious anomaly. A proper

perpetuating bill was drawn up, but the change of Government, from Derby to Palmerston, allowed another bill to be quickly prepared and passed in 1859 (122) - but even then it was only by the narrowest of margins.

The Local Government Act 1858 now made it possible for towns to adopt directly - instead of having to obtain a private local act as before - certain provisions of the Clauses Acts - and therefore parts of the Towns Improvement Clauses Act of 1847 (123). Other parts of that Act had already been maintained in the Public Health Act of 1848. The Act still preserved the permissive character of the earlier legislation and the opportunity to force a sanitary code on a reluctant local district was again lost. Yet whilst the earlier Public Health Act had left the decision over the use of by-laws to control streets and buildings largely at the local authorities' discretion, Parliament were now, in a sense, making a more positive recommendation for the use of these controls.

The most important part of the Local Government Act, from our point of view was Section 34. This section repealed the 53<sup>rd</sup> and 72<sup>nd</sup> clauses of the Public Health Act, "and in lieu thereof be it enacted as follows: "Every Local Board may make by-laws with respect to the following matters, that is to say:

1. With respect to the level, width and construction of new streets and the provisions for the sewerage thereof,
2. With respect to the structure of walls of new buildings for securing stability and the prevention of fires.
3. With respect to the sufficiency of the space about buildings to secure a free circulation of air and with respect to the ventilation of buildings.
4. With respect to the drainage of buildings, to water closets, privies, ashpits and cesspools in connection with buildings and to the closing of buildings or parts of buildings unfit for human habitation, and to the prohibition of their use for such habitation.

And they may further provide for the observance of the same by enacting therein such provisions as they think necessary as to the giving of notices, as to the deposit of plans and sections by persons intending to lay out new streets or to construct buildings as to inspection by the local Board and as to the power of the Local Board to remove, or pull down any work begun or done in contravention of such by-laws; provided always that no by-laws shall affect any building erected before the date of the constitution of the District" (a possible loophole which was to render the act largely ineffective). "But for the purposes of this Act the re-erecting of any buildings pulled down to or below the

ground floor, or the conversion into a dwelling house of any building not originally constructed for human habitation, or the conversion into more than one dwelling house of a building originally constructed as one dwelling house only, shall be considered the erection of a new building".

Section 35 allowed local boards to prescribe the line of building when houses had been taken down or were to be rebuilt, precedents for which lay immediately in the Towns Improvement Clauses Act and the Metropolis Local Management Act of 1855.

Compared with the more limited provisions of the Public Health Act, with respect to building matters, that is to cellar levels, privies, cesspools, streets and courts, one can now see, just ten years later, a considerable broadening of building regulations, to include walls, fire, stability and space about building. These were matters which, it is true, have appeared in much earlier legislation, but the extension into the Public Health and Local Government field was facilitated by two factors. First, the establishment of a suitable legislative and administrative framework under the Public Health Act of 1848, together with its modifications in the corresponding Local Government Act of 1858. Secondly, the timing of the new Metropolitan Building Act, and the new Metropolis Local Management Act both in 1855, the same year that the moves began which eventually came to the surface in the Local Government Act of 1858. There is more than coincidence here and the similarities between the London Act of 1855 and the first Form of By-laws of 1858 will be studied in Chapter V. That the idea of such a relationship was in the air, may be seen from the following comment made in 1856:

"Increased powers in regard to new buildings are also proposed to be given by the Bill [Local Government Bill]: but we think it is to be regretted that such provision of the Metropolitan Building Act of last session, as may be of general application, are not incorporated in the Bill. The dimensions of party walls and other like matters must be as applicable to the structures in Provincial towns as they are applicable to like structures in the Metropolis, and ought therefore to be matters not left to the discretion of the local authority. The Bill requires that information as to the details of the structure be communicated in a prescribed form to the Local Board, who may thereupon either approve or disapprove of the plan and other particulars either with or without modification but in lieu of this, defined rules should be laid down for the construction of all buildings within the district, in like manner as is done in regard to buildings within the Metropolis" (124).

\*\*\*

This chapter has covered a number of themes which might at first sight

appear to be rather disparate, but which it was felt were essential to the evolutionary context of this work. Each of these themes has received more detailed study in authoritative works elsewhere, though whilst this is true of the history of public health and local government, the subject of the early improvement acts appears to be a field which is still relatively undisturbed. One suspects that there may well be more to uncover here, but such archaeological work is clearly beyond the terms of this Thesis. Selected here were what appeared to be the most relevant topics and they have been brought together in this the third of our three routes into the subject. This particular route is more diverse and lacks the single theme of the two preceding chapters. Nevertheless in its attempt to reach further back and to identify the development of the machinery for regulation and the attitudes which underlie it, it is equally as important.

From this position it is now possible to look back and to draw out the more significant factors, significant in the immediate context and those which perhaps have a relevance in the longer term.

In the immediate context it is necessary to point out first of all how indeterminate are the origins of many of the regulations. There would appear to have been controls, albeit of a primitive nature, in existence for some time before the 19th century, to ensure the safety of the public in so far as they were exposed to danger in the streets - and one source of that danger was from buildings. They were simple and were not always effectively implemented, but they did exist and if nothing else they must have prepared the ground for the later extension of the concept of building regulation.

Secondly, one should note the importance attached to the uniqueness of the local control, which was often related specifically to local characteristics. Such local variations, reflecting local traditions, materials, climate, building techniques and customs are an important part of the evolutionary pattern. Yet in contrast to this we have seen the attempts, by means of 'Normal' Acts and the Clauses Acts to achieve some measure of uniformity and standardisation, to effect more economic and workable legislation, but such a tendency was contrary to local requirements and led to antagonism and misrepresentation. This very tension, between a developing central controlling agency in the form of



government and the resistance of local prejudices, leading to distrust, suspicion, misunderstanding and a lack of co-operation is to be a continual factor in this history.

Thirdly, we have seen the emerging pattern of the mechanisms of public health control and local government control. There was an increase in their scope and effectiveness and there was a parallel increase in the scope and effectiveness of the regulations as they effected buildings. And the key to all this lay in London. Many towns had similar problems, Liverpool in particular, but none were on the scale of London. It was London where the legislation was formulated, even the local acts passed through a central Parliamentary control and filter, and the Clauses Acts were designed as much for Parliamentary efficiency as for the benefit of the towns. Moreover, the legal draftsmen themselves, resident in London, had on their own doorstep one of the more advanced local building acts in the form of the Metropolitan Building Act to provide a guide. The significance of this influence must not be underestimated.

In the longer term, the facts which remain with us today are in many cases those we have just mentioned. There is still a feeling that local variations should be accommodated in our building regulations, that what is applied in Northumberland will hardly be relevant in Cornwall. There is still some vestige of the long felt suspicion between Whitehall and the local Town Hall, as the local officer attempts to interpret the regulations laid down by an anonymous Ministry. And there is another characteristic which we have not mentioned before, but one which becomes clear as one studies the fragmentary nature of our building regulations, namely a preference to alter our laws in slow and small stages. We prefer the very guarded approach, watching each minor change and tinkering in a very piecemeal fashion - tedious and infuriating but apparently preferable to the alternative of a whole scale imposition of a definitive set of orders.

At this point we have now completed in the first three chapters the three routes that were outlined in the introduction - that is the need for sanitary reform, the development of London's legislation and the development in the Provinces. We can now resume the progress of the evolution of the building regulations and trace it in the form of parallel developments between London and the Provinces from the middle of the century onwards.

\*\*\*

NOTES TO CHAPTER III

- 1 'An Act for consolidating in one Act certain provisions usually inserted in Acts authorizing the taking of Lands for undertakings of a public nature'. 8 Vic.cap.18 8 May 1845.
- 2 S.E.Finer, 'Life and Times of Sir Edwin Chadwick', London, 1952, p.295.
- 3 Local Government Act : 21 and 22 Vic.cap.98 Sections 44,45,50 and 75.
- 4 10 and 11 Vic.cap.14 Markets and Fairs.  
cap.15 Gasworks.  
cap.16 Commissioners.  
cap.17 Waterworks.  
cap.27 Harbours, docks and piers.  
cap.34 Towns Improvement.  
cap.68 Cemeteries  
cap.69 Town police.
- 5 9 and 10 Vic.cap.106 (1846).
- 6 F.Clifford, 'History of Private Bill Legislation', Vol II, London, 1885 - 7, p.291.
- 7 R.A.Lewis, 'Edwin Chadwick and The Public Health Movement 1832-54', London, 1952, p.137.
- 8 F.Clifford, op.cit.  
F.H.Spencer, 'Municipal Origins, an account of English Private Legislation relating to Local Government 1740-1835', London, 1911.  
S.and B.Webb, 'English Local Government : Statutory Authorities for Special Purposes', London, 1922.
- 9 F.H.Spencer, op.cit. p.309.
- 10 Ibid. p.204.
- 11 14 Chas. II cap.2 1662.
- 12 E.g. Salisbury Local Act.10 Geo.II cap.6 which repeated in substance the first three clauses of the London Act of 1662.
- 13 E.g Southwark Local Act. 6 Geo.III cap.24 (1766).
- 14 E.g Norwich Local Act.6 Geo.IV cap.78 (1825).
- 15 E.g Ardwick Local Act.6 Geo.IV cap.5 (1825).
- 16 E.g Skinner's Estate St Pancras.Local Act 48 Geo.III cap.86 (1808) and Brighton Local Act.50 Geo.III cap.38 (1810).  
(Also a York Local Act allowed spouts and pipes to project a maximum of 5" from the side of a house, and no cornice or horizontal spout to project more than 14". Bishops Wearmouth Local Act required downpipes to be only down to 6" above the ground. Tewkesbury Local Act, 26 Geo.III cap.17 (1786) required roof water to be conveyed in pipes either down to the private ground of the owner or under the foot pavement into the common drain or channel).
- 17 E.g Dover Local Act.50 Geo.III cap.26 (1810) and Bristol Improvement Act.28 Geo.III (1788).
- 18 E.g Dover Local Act, op.cit., and Hastings Local Act, 1 Geo.IV cap.12 (1820).
- 19 E.g St James' Clerkenwell Local Act.14 Geo.III cap.24 (1774).
- 20 Liverpool Building Act. 6 Geo.IV cap.75 (1825).
- 21 Macclesfield Local Act. 6 Geo.IV cap.196 (1825).
- 22 Newport Local Act. 7 Geo.IV cap. 6 (1826).
- 23 F.Clifford, op.cit. vol ii, p.307. (Act: 5 and 6 Vic.cap.104 1842).
- 24 Rochdale Local Act, 7 and 8 Vic.cap.104 (1844).  
Southampton Local Act, 7 and 8 Vic. cap.75 (1844).

- Manchester Local Act, 7 and 8 Vic. cap.40 (1844).
- 25 43 Geo. III cap.10 (1803).
- 26 Towns Improvement Clauses Act, 1847 clause 24.
- 27 F.H.Spencer, op.cit. p.319.
- 28 22 Geo. III cap.83 (1782).
- 29 57 Geo. III cap.29 (1817).
- 30 C. C. Knowles and P.H.Pitt, 'History of Building Regulation in London 1189-1972', London, 1972. p.56.
- 31 54 Geo. III cap.109 (1814).
- 32 5 and 6 Will. IV cap.50 (1835).
- 33 3 Geo. IV cap.126 (1822).
- 34 3 and 4 Will. IV cap.90 (1832) also Royal Sanitary Commission Report, 1871, p.5.
- 35 E.P.Hennock, 'Urban Sanitary Reform, a generation before Chadwick' Economic History Review, (1957-8), Vol. X, p.117.
- 36 J.Redlich and F.W.Hirst, 'Local Government in England', London, 1903. 2 vols.
- 37 W.G.Lumley, 'An Essay on By-laws, etc'. Knight and Co., London, 1877 and see also The Builder Vol.35 No.1814 10 November 1877 p.1118.
- 38 B.Vol. 102 No. 3610 12 Apr 1912 p.431.
- 39 Ibid.The case was Yabbicom v.King 1899 1.Q.B. 444.
- 40 Sheffield Borough By-laws 1844 no.2 compare with Towns Improvement Clauses Act 1847 clause 73.
- 41 Sheffield op.cit. no 7 - Towns Improvement Clauses Act clause 79.
- 42 Ibid.no.18 and clause 75.
- 43 Ibid.no.15 and clause 74.
- 44 Ibid.no.19 and clause 71.
- 45 The Times, 29 June 1847 p.6 col.b.
- 46 Towns Improvement Clauses Act 1847, clauses 7 and 9 - compare with Public Health Act 1848, clause 37.
- 47 Ibid.Act 1847 clause 12 compare with Act 1848 clause 40.
- 48 9 and 10 Vic.cap.127 (1846).
- 49 Towns Improvement Clauses Act 1847, clause 13.
- 50 Ibid.clause 15.
- 51 Public Health Act 1848 clause 41.
- 52 B.Keith-Lucas, 'Some influences affecting the Development of Sanitary Legislation in England', Economic History Review, vol. 6, p.295 (1954).
- 53 8 and 9 Vic.cap.7 (1845).
- 54 6 and 7 Vic.cap.13 (1843).
- 55 50 Geo. III cap.26 (1810).
- 56 The Calais Paving Act, 2 and 3 Edw.VI cap.38 (1548) is an example. The Mayor and Aldermen were required to repair four main streets, but the other streets were the responsibility of the owners of property adjacent to the street.  
(The Calais Act is unique, being the only case of English regulations operating outside these islands. Following its capture in 1347, Edward III made efforts to anglicize the town by removing the French population and granting land and houses to the English). See Clifford F. op.cit. Vol.II, p.262 and 267.
- 57 S.and B.Webb, op cit.
- 58 Poor Law Commission Report on Inquiry into Sanitary Condition of the Labouring Population of Great Britain 1842, p37 (Chadwick's Report).
- 59 21 Geo. III cap.72 (1781).
- 60 F.Engels, 'The condition of the Working Classes in England' 1887 edition, p.37 quoted in J.H.Chapman, 'Economic History of Modern Britain, Vol.1 1820-50', Second edition, Cambridge, 1964.

- 61 Even today, the insertion of an 'up and over' door to a garage directly facing a by-law back street can still unintentionally infringe this old regulation.
- 62 S. and B. Webb op.cit. p.238.
- 63 10 and 11 Vic.cap.89 clause 28 (1847).
- 64 F.Clifford, op.cit. p.267.
- 65 8 and 9 Vic.cap.7 (1845).
- 66 See Royal Sanitary Commission Report 1871, p.4 for summary of the history of Sanitary Laws. Early Acts were : 6 Henry VI cap.5; 4 Henry VII cap.1; and 23 Henry VIII cap.5.
- 67 F.Clifford, op.cit. p.288.
- 68 Royal Commission on State of Large Towns and Populous Districts 1844, First Report, p.9.
- 69 Ibid.
- 70 Royal Commission on Metropolitan Sewerage 1884, p.xi.
- 71 9 and 10 Vic.cap.127 clause 85 (1846).
- 72 B.Keith-Lucas, op.cit. p.295.
- 73 8 and 9 Vic.cap.7 (1845).
- 74 6 and 7 Vic.cap.13 (1843).
- 75 3 and 4 Vic.cap. 26 ? (1840).
- 76 J.Hole, 'The Homes of the Working Classes with Suggestions for their Improvement' London, 1866.
- 77 22 Chas.II cap.11 sec.8 and 26 Geo.III cap.12.
- 78 6 Geo.IV cap.75 (1825).
- 79 2 Will.IV cap.90 (1831).
- 80 Metropolitan Building Act 1844, Schedule F and later Metropolitan Building Act 1855, clause 21.
- 81 Bristol Act, 1788.
- 82 6 Geo.IV cap.196 (1825).
- 83 9 and 10 Vic.cap.127 (1846).
- 84 B.D.White, 'History of the Corporation of Liverpool 1835-1914', Liverpool, 1951, p.38.
- 85 Bristol Act.10 and 11 Vic.cap.<sup>129</sup>(1847).
- 86 B.Keith-Lucas, op.cit. quotes Liverpool Acts of 1842 and 1846, Birkenhead Act 1843 and Wallasey Act 1845.
- 87 8 and 9 Vic.cap.7 (1845).
- 88 Liverpool Acts of 1842 and 1846 and Birkenhead Act 6 and 7 Vic. cap.13 (1843).
- 89 8 and 9 Vic.cap.7 (1845).
- 90 J.Hole, op.cit. p.5 and M.Bruce, 'Rise of the Welfare State', London, 1973, p.88.
- 91 8 and 9 Vic.cap.7 (1845).
- 92 Birkenhead Act 1843 and Wallasey Act 1845.
- 93 H.Vol. 77 p.449 14 Feb 1845.
- 94 H.Vol. 82 p.1077-8 25 July 1845.
- 95 9 and 10 Vic.cap.96 (1846).
- 96 J.L.and B.Hammond, 'The Age of the Chartists', London, 1930, p.299.
- 97 H.Vol. 95 p.265 29 Nov 1847.
- 98 H.Vol. 96 p.383 10 Feb 1848.
- 99 J.L.and B.Hammond, op.cit. p.306.
- 100 11 and 12 Vic.cap.63 and H.Vol. 101 p.726 31 Aug 1848.
- 101 J.L.and B.Hammond, op.cit. p.309.
- 102 Ibid.
- 103 J.Redlich and F.W.Hirst op.cit. p.143 (Vol I).
- 104 J.C.Hall, 'Facts which prove the immediate necessity of Sanitary Reform', Second Edition, 1848. pp.46-7, clause ix.
- 105 11 and 12 Vic.cap.123 (1848), amended in 1849 as 12 and 13 Vic. cap.111.

- 106 Nuisances Removal Act.9 and 10 Vic.cap.96 (1846).  
107 Sir J. Simon, 'English Sanitary Institutions', London, 1890. p.208.  
108 S.E.Finer, op.cit., p.459.  
109 J.Redlich and F.W.Hirst, op.cit. p.148. (Vol I).  
110 18 and 19 Vic.cap.116 (1855).  
111 18 and 19 Vic.cap.121 (1855) (and which repealed the earlier Acts of 1848 and 1849).  
112 18 and 19 Vic.cap.122 (1855).  
113 18 and 19 Vic.cap.120 (1855).  
114 17 and 18 Vic.cap.95 (1854).  
115 18 and 19 Vic.cap.115 (1855).  
116 21 and 22 Vic.cap.97 (1858).  
117 21 and 22 Vic.cap.98 (1858).  
118 H.Vol. 149 p.1583 23 April 1858.  
119 H.Vol. 149 p.2095 30 April 1858.  
120 Sir J. Simon, op.cit. p.274-5.  
121 Ibid. p.276.  
122 22 and 23 Vic.cap.3 (1859).  
123 i.e. street names, house numbering, improvement lines, dangerous buildings, precautions in the construction of sewers, streets and houses; water supply, smoke prevention, slaughter houses, town clocks; - as under clauses 44,45,50 and 75 of the Local Government Act 1858.  
124 Justice of the Peace, Vol. XX, No. 24 14 June 1856 p.371.
-

'An Act for consolidating in one Act certain provisions usually contained in Acts for paving, draining, cleansing, lighting and improving towns'

10 and 11 Vic.cap.34

DATE: 21 June 1847

Reference in text: page: 134

	SELECTED CLAUSES relating to building design and construction. Summary of contents	LINKS	
		ANTE	POST
113	<b>HABITABLE CELLARS</b> Cellars in courts not to be occupied as dwellings.	L'pool 1842 clause 10	Public Health Act 1848 cl.67
119	Height for cellar dwellings to be 7'0" min.	L'pool 1842 clause 11 and T4.ScK	as above and T6.c103
63	<b>STREETS</b> Carriageways = 30'0" min.wide. Non-carriageways = 20'0" min.wide.	T3.c18 and L'pool 1846	Public Health Act clause 72 but no dimensions given
63	Streets to be named and houses to be numbered.	Bristol 1840 clause 36	T6.c141
19	Powers given to purchase and remove buildings for improvement of streets.	Bristol 1840 clause 34. St James' Clerkenwell 1774	Public Health Act 1848 cl.84
66	Powers for houses, to be set in relation to the line of the street.	Bristol 1788 Dover 1810 Bristol 1840, clause 21	Local Gov. Act 1858 sec. 35 and Met Local Management Act 1855
47 56	Requirement for streets to be properly paved.	see text p. 135	Public Health Act 1848 clause 68-73
69- 70	Allows for the removal of all future and existing projections.		
71	Doors opening onto streets to be hung so as to open inwards - except for public buildings.		
73	Openings to cellars and vaults to have secure coverings. Provisions for Commissioners to contract for lighting the streets.	Bristol 1840 L'pool 1837	Public Health Amendment Act 1849
109	<b>STRUCTURE</b> Party walls to be carried up through roof to project 12", at right angles to slope.	T3.c33 T4.ScD and Bristol 1788	T7.c8 and T6.c17

109	Roofs to have incombustible coverings.	T4.Sc.G	T6. c19
110	<b>SPACE ABOUT BUILDINGS FOR VENTILATION</b> Every church, chapel, school, place of public amusement etc, or building for holding large numbers of people for any purpose whatsoever: A plan and description to be submitted to show construction with respect to means of supplying fresh air.	Royal Comm. on state of Large towns and Populous Districts 1844-5 Recommendation no 26	T7.c18
31	<b>DRAINAGE</b> Prevents building over public sewer without permission, or a vault, arch or cellar under the street.		Public Health Act 1848 cl.47
32	All sewers and drains, either public or private to have proper traps.	L'pool 1846 clause 85	as above, clause 44 and T7.c21
35	If house is within 100'0" of public sewer then Commissioners to have power to connect and to charge owner.	T4.ScH	Public Health Act 1848 clause 49
36	No house to be built without drains.		
37	In rebuilding, level of cellar to be such as to permit proper construction of drains.		as above, clause 53
42	Owners to provide ashpits and privies.		as above clause 51
44	All drains, privies and cesspools to be kept in good order.		as above clause 54
74	Roof drainage: water shoots, or troughs along entire length of building, connected to adjoining house or downpipe.	T4.ScG	T6.c26
121	Powers to construct public cisterns for baths and wash-houses.		P.H.A. 1848 clause 75
124	Provision for fireplugs and hydrants, with marker plates on walls.	London 1774	
108	<b>MISCELLANEOUS</b> Fireplaces of factories to consume their own smoke.		
200	Powers to make By-laws.		

Notes: Clause 19 was linked to the Land Clauses Consolidation Act 1845 (8 Vic.cap.18) In Public Health Act 1848 cl.44 there is no specific mention of 'traps', as in Towns Improvement Clauses

Act clause 32.

Clause 124 was not a 'normal clause' in earlier local acts - according to Spencer it rarely appears before 1820. London 1774 is therefore exceptional.

Under clause 200, Commissioners 'may make by-laws as they think fit for the several purposes contained herein etc., provided such by-laws be not repugnant to the laws of that part of the United Kingdom where the same are to have effect'.

The Act also covered : ruinous and dangerous buildings, precautions against repairs hoardings and lights at night, street cleansing, lodging houses, slaughterhouses, public bathing, town clocks, rates and nuisances.

LIVERPOOL BUILDING ACT 1846 (9 and 10 Vic.cap.120) clause 120.  
Attic room heights

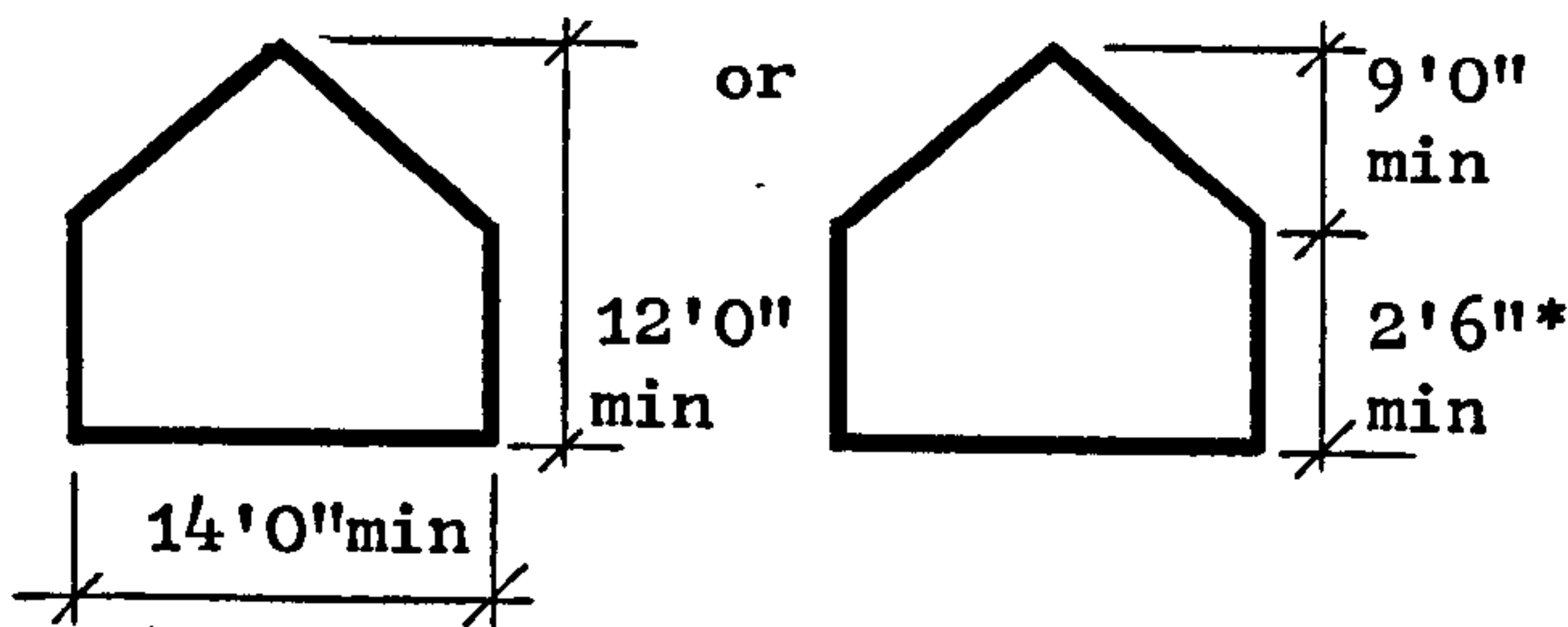

SECTIONS Not to scale

'Attic' for purposes of this act only in house with 3 floors above basement.  
 If dimension \* is greater than 2'6" then the 9'0" dimension may be reduced by an amount not greater than double the excess. (but not to be less than 8'0" from floor to ridge).



## CHAPTER IV

### THE METROPOLITAN BUILDING ACT 1855-1875

This chapter continues the further development of the building regulations in London, a development which is important since the London codes form the major part of the foundation upon which the later Model By-laws were to be based. The account is resumed at the point at which it was left in Chapter II, at 1855, and is analysed in three sections. The first focusses on the more salient points of the new Metropolitan Building Act of 1855 itself, and with it those matters related to building which were transferred to the Metropolis Local Management Act of the same year; the second considers the development of the Act, its various short-comings and the measures proposed for its amendment by Parliament, the medical world and the architectural profession; and the third describes the practical course of the Act and the calls for its amendment in the face of the problems it encountered as it sought to control the three aspects of public safety : fire, stability and health.

\*\*\*

The first section, analysing the Acts, is to be read in conjunction with Table 6, where the principal contents of the Act are summarized and grouped in the following pattern namely, cellars, streets and drainage in the Management Act, and structure, ventilation and space about buildings in the Building Act.

In general terms it may be said that the new Act, whilst succeeding in consolidating and re-arranging the technical regulations (and extending the rules for the District Surveyor, for the control of dangerous structures and for the administration of party wall matters, all topics which lie outside our present terms of reference), made very little in the way of fundamental change and gave scant recognition to the pressures for modernization which had been so strongly voiced in the preceding years. Only three areas were in any sense novel - the change in the method of determining the thickness of walls, the proportion of openings in relation to the area of the external wall and the rules for the separation of buildings. Otherwise the changes were of a relatively

minor nature, merely adjusting the technical dimensions in most cases, and all of these were set in the already well established and accepted areas of control. In spite of the evidence brought by various committees and experts in the years preceding the new Act, there were a number of important areas requiring control that the legislature found itself unable to accept at this stage in London, even though they had featured for some years in local acts elsewhere. Examples of these topics were the need for a damp proof course, for proper foundations and the preparation of the site, the composition of mortars, the size of timber joists and purlins, the strength of columns and girders, ventilation under the floors, windows and the ventilation of rooms - all matters which were familiar, all of which came through in the Model By-laws, yet all of which were omitted at this stage of the London regulations.

With respect to the extent of the regulations controlling buildings, one may note in passing both a closer definition and more reasonable set of rules relating to the exemption of certain buildings from the operation of the Act and, more importantly, the changes to the rules affecting warehouses and tenement buildings. The cubic content of a warehouse was now set at a maximum of 216,000 cu.ft, and warehouses over that size had to be subdivided into compartments of that size by proper party walls. Tenements, that is, buildings containing sets of rooms tenanted by different persons, had, if the building was over 3,600 sq.ft, to be interpreted as though the separate sets of rooms were separate buildings, and separated accordingly by proper party wall and floor construction. Furthermore, the stairs, lobbies, corridors, passages and landings in buildings over 125,000 cu. ft, used as 'a dwelling house for separate families' had to be of stone or other fire-proof material. These rules were to have a marked affect on the design of the newly emerging building type, the 'model dwellings' for the Artizan class (1).

\*\*\*

#### Cellars (Table 6, sheet 1)

The Metropolis Local Management Act now incorporated the controls on cellars, streets and drainage. The controls on habitable cellars maintained the basis established by the Metropolitan Building Act of

1844, but they can be seen now to have incorporated some of the controls which the Public Health Act of 1848 had employed for the same topic. The use of a w.c., privy or ashpit for the cellar dwelling was, for example, a direct insertion taken from the Public Health Act. The need for a part of the cellar to be 1'0" above street level followed the thinking of the Public Health Act, although these dimensions had been set at 3'0", much closer to the Liverpool standard. The requirements for the external steps down to the cellar, not to be over or across the cellar window was a further influence, although the Public Health Act required the additional rule for the steps to be at least 6" away from the house wall. The width of the open 'area' however, remained in the London Act at 3'0" minimum - more generous, by a mere 6", than its counterpart in the Public Health Act.

Streets and Drainage (Table 6, sheet 1)

Controls on the width of streets were not specified in dimensional terms in the Local Management Act itself, but they duly appeared in the subsequent by-laws in 1857, when they were seen to maintain the standards of the 1844 Building Act, but with one important exception. The control relating the height of buildings and the width of streets was now omitted. No positive reason was given for this, but there may have been some truth in the interpretation offered by the architect Robert Williams in 1896. He claimed that it was due to the strong pressures brought by the landlords and speculators who were building what he refers to as "block dwellings" - tenement dwellings for the working classes. The builders tended to think that it was the block system itself, rather than any relationship between its height and the adjacent open space, which gave these dwellings greater salubrity over the slums - "so they managed to get the restriction on height removed" (2). When coupled with the fact that there was no limit set by the Building Act of 1855 to the height of walls, the effect on narrow streets was to be severe and it is not surprising to see that this important relationship was reintroduced, albeit seven years later and in a modified form, in the amendment Act of 1862. (Table 6, sheet 1). The use of the by-law for the control of streets, the level of buildings and drainage (under clause 202 of the Local Management Act) is again a parallel to the example set by the Public Health Act, where clauses 53 and 72 had given enabling powers for by-laws to be made to control these matters. The

inclusion of the building line control, within a specified zone up to 30'0" from the highway, is new in the London Act, although it had precedents in the Towns Improvement Clauses Act of 1847 (though no dimensions were given there) and in a number of earlier local acts some of which had, of course, operated in parts of London (3). This was a result of the increasing pressure from the trade interest to build out into the front gardens of the older houses in the expanding suburban shopping areas, but it was often far from effective (see later, page 197). Drainage, now under by-law control, was further elaborated from the very basic provisions set in the Building Act of 1844, again as a result of the Public Health Act of 1848. Proper w.c's, privies and house drainage were required, as were trapped gullies (coming from both the Liverpool Act of 1846 and the Towns Improvement Clauses Act of 1847) but the provision for combined drainage for blocks of houses appears to be new, and probably coincides again with the building of an increasing number of tenements and 'model dwellings' for the working classes.

#### Structure (Table 6, sheet 3)

The most important innovation in the matter of structure was the new method of determining the thickness of walls - a method which now applied to both external and party walls alike, as had been first proposed in the abortive bills of 1849 and 1851. With the abolition of the old system of 'rating' and classification by area, the new controls were set by the height, the length of the wall and the number of storeys. The height was now measured from the base of the wall to the top of the topmost storey, this being to the underside of the roof tie or to half the vertical height of the rafters if there was no tie; the alternative to a point 3'0" below the ridge of the 1844 Building Act being now omitted. The lengths of the walls were divided into three categories, but the wall itself could be divided into distinct lengths for the purposes of the calculations, if it was braced by proper cross walls - which themselves were now subject to more specific controls. Furthermore, and as a sign of an increasing awareness of the interdependence of the various elements of a structure, modifications were allowed if the walls were connected by means of floor joists to another external or party wall, provided it was not more than 25'0" from the wall in question. The table of the various permutations shows that a greater variety of situations were now covered, as opposed to

those in the 1844 Building Act, but it is possible to see the maintenance of the 1844 standards, particularly in the part of the rules governing the shorter wall lengths within the respective height categories. Walls of greater length naturally led to an increased thickness to ensure stability and although they were roughly equivalent on a proportional basis, there is no strictly regular or consistent pattern.

Two defects should be noted in these new standards. First, the upper parts of walls up to 50'0" in height were still set at  $8\frac{1}{2}$ " in thickness, the earlier Act had allowed them, but no higher than 38'0" above the base. Notwithstanding doubts about their performance to prevent damp penetration at even the lowest levels, to allow them to be built at even higher and more exposed positions was a retrograde step. The same objection incidentally, can be levelled at the  $8\frac{1}{2}$ " thick walls at the top storey of warehouses, when the walls were not over 30'0" in height. The second defect lay in the actual technique of determining the thickness of warehouse walls below the top 16'0". This required solid brickwork to occupy the tapering zone established by the two imaginary lines connecting the thickness at the top with the thickness prescribed for the base. This led to problems of interpretation - should the inevitable offsets in the brick courses be within or outside this imaginary envelope?

The second innovation was the control on the relationship between the area of openings and recesses and their surrounding wall area. Set at a proportion of one half void to one half solid, this, together with the continuation of the requirement for walls to be of brick or stone, tended to maintain the traditional pattern of loadbearing wall design established in the Georgian period. At the same time, it severely limited the possibilities of frame construction and, especially now that the window tax was abolished (in 1851), the use of an increased area of glazing.

Amongst the more minor matters connected with structure, the following may be noted, as they all have a bearing on the contents of the latter Model By-laws of 1877. The change in the terminology for walling materials has been mentioned in an earlier chapter (see page 94), but in addition there was the requirement for a greater wall thickness when

stone walls were not laid in horizontal beds; a standardised formula for the dimensions of footings, determined by the thickness of the wall above; and concrete for foundations (though no dimensions were given). No part of a wall could overhang any part of the wall underneath, a drawback to those in the Gothic school who desired a more richly modelled facade, but otherwise projections followed the 1844 Building Act, although they no longer needed to be of the same material as the wall. Commercial pressures account for the omission of two rules : one limiting the height of shop fronts in streets less than 30'0" wide, the other the limitation to the height of signboards. Parapet walls could now be of the same width in all situations, but the height of the party wall parapet was reduced to 15", coming therefore precisely halfway between the 18" of the 1844 Building Act and the 12" of the Towns Improvement Clauses Act. At the same time, the height and width of the walls separating dormers and turrets were reduced by 12". The rules on timber in walls were simplified, but the 4" rule for all woodwork (except bressummers, storey posts and shop frames) to be set back from the face of the external wall remained, the only concession being for loophole frames (access hatches) in warehouses. The rules for bressummers were again adjusted, the principal change being the omission of the additional supporting columns which the 1844 Building Act had required when the bressummer was carried on the party walls. The width of chases in party walls was increased from 9" to 14", no doubt as the result of the experience and increasing use of larger pipework for plumbing and heating.

A sensible reversion to traditional practice was the allowance for chimneys to be once more allowed to corbel out from the wall, but within certain limits, and it will be seen that the earlier concern over angle chimneys was now felt to be unjustified and the rules controlling them were therefore omitted. Very minor modifications were made to the angle of flues, the thickness of the backs of flues and the thickness of hearths. Rather more significant were three new rules for chimneys, one controlling the thickness of the upper side of a flue when set at a low angle, one requiring flues against party walls to be separated by withes (dividing walls) which had to be properly bonded to the party wall, and one determining the height of a chimney stack by a proportional system based on its width. Various modifications were made to soot doors, ventilating valves, the distance of timber and iron from the inner

face of a flue and the matter of 'close' fires (stoves). In recognition of the earlier controversies over the rule separating heating pipes from timber by 14", this was now re-framed, and separate rules, with closer distances, were specified for pipes containing either hot air, steam, hot water or smoke.

\*\*\*

#### Ventilation and Space about Buildings (Table 6, sheet 7)

These topics saw two alterations from the 1844 Building Act. The curious rule for 'a three-quarter square' (75 sq.ft.) in the earlier Act was now omitted, and the 1855 Building Act called for a back yard of one square (100 sq.ft.) to apply exclusively to each house, unless it could be lit and ventilated from an adjoining street. It did not say however at what level this open space was required, and, as we shall see later in this chapter, it was possible to encroach onto this area at ground level with building. Neither, of course, did it say what this area was for, nor that a window should overlook it and what the minimum length or breadth of the area should be.

Room heights still remained at 7'0" minimum, in spite of the pleas from the sanitary experts for higher and better ventilated rooms. The attic room clause was however rephrased to give 7'0" clear over at least half the area of the room. There was now no reference to the 'sloping parts' nor, more specifically, to the limit on the number of storeys in the roof.

\*

Such were the limitations to the controls in London in 1855, limitations that were to remain largely intact until the next major Building Act in 1894. By that time however, the majority of the large towns in the country were ahead of London, having by-laws based on the more comprehensive range of controls set out in the Model By-laws of 1877 - but those very Model By-laws owed a great deal, as we shall see, to the contents and working of the earlier London regulations. That is for a later chapter. We now turn to consider the operation of this 1855 Building Act in the period up to 1875, the date of the Public Health Act.

Parallel activities in the Health movement and the provincial regulations are discussed in Chapter V.

\*\*\*

### The Course of the Metropolitan Building Act 1855-1875

The Metropolitan Building Act, together with the Metropolis Local Management Act, came into force on New Year's Day 1856 and almost immediately entered on its unhappy course, being subjected to a rising storm of protest from all quarters and a succession of numerous amending bills, most of which were to be abortive. The attacks also focussed on the new Metropolitan Board of Works, described by one correspondent to 'The Builder' in 1856 as "the most thoughtless or else the most sinful and wicked body that ever met together" (4). The Board had the unenviable task of holding together the new structure of control, in the face of frequent skirmishes and disagreements between the builders, architects and District Surveyors. Considering the lengthy period of gestation for the new Act, there was a natural reluctance to introduce new changes too quickly, but even so, the Board had, by the end of the second year of operation, already set up a special committee to monitor the working of the Act and identify its faults (5).

The attacks on the Act ranged from prejudiced protests to constructive criticism, but to avoid a lengthy and tedious account of every detail, it will facilitate this section if the subject is seen from three points of view. The first surveys the succession of amendments to the Act, the second identifies the more vocal demands for reform made by the Medical Officers of Health, and their champion Dr. Liddle in particular, and the third will review the criticism which emanated from the architectural profession. Although divided into these three sections, it is to be understood that all three are interrelated.

Within the Local Management Act, three amendments can be recorded. The first, not strictly an amendment but rather an extension of control, is the production of the New Street By-laws in 1857 - a matter referred to in the earlier part of this chapter (page 164) (6). The second was a minor amendment in the same year, 1856, related to the administrative duties of the Vestries (7) and does not come within the scope of this



work. The third amendment was rather more significant. This was the amending Act of 1862 (8) which referred also to streets, repeating in Section 98 the requirements for widths, but in Section 85, reintroducing the relationship control between building height and street widths. Under this clause, the height of buildings (except Churches and Chapels) in streets under 50'0" in width was to be limited so that the height was the same as the width of the roadway as measured between the buildings.

To the Building Act of 1855, four amendments, none of them very extensive, managed to reach the Statute Books. The first of these, of July 1860 (9), provides an interesting example of the power and influence which the world of trade could generate at this period. It was devised in answer to the protest from the manufacturers of boilers for steamships, who found that the rules in the Act limiting the cubical dimensions of warehouses and factories prevented the construction of larger boilers for the new and more powerful ships that this maritime nation required - boilers that had to be manufactured and tested in one piece. The rules for boiler manufactories, situated further than 3 miles from St. Paul's Cathedral, were therefore relaxed by this amending Act, provided the building was of single storey, built of brick or stone or other incombustible material and not used for any other purposes (10). The second amendment was a minor matter, though it reflects an unusual aspect of the workings of the Act. It simply confirmed that the Building Act did not apply to the buildings of the Commissioners of the Exhibition of 1851 (11). The 1855 Building Act had repealed the Exhibition of 1851 Roads and Lands Act (12), but faced now with the prospect of a further exhibition in 1862, this amendment was passed to reverse that rule and to allow the building of the new exhibition to proceed outside the control of the Building Act - as had its predecessor in 1851. The third amendment of 1869 (13), although preceded by a number of abortive and larger measures, simply resulted in little more than the transfer of the powers over the matter of dangerous structures from the police magistrates to the Board of Works (14). Finally, in 1871, an amendment was passed to allow the Foreign Cattle Market at Deptford to be exempt from the Building Act, an exemption which was considered very questionable by 'The Builder', who saw it, along with the exemption granted to Railway Companies, as a "dangerous development" (15).

Just four minor amendments over a period of nearly twenty years, but between those four which succeeded, there was a continual succession of failures. Certain of these are selected here, since they serve to illuminate the pressure and attitude of the period towards the concept and function of the Building Act.

The Gilbert Street fire in 1858, in which 15 died in badly built and overcrowded lodgings led to a special enquiry and report which called for an amendment to the Building Act, as well as change to the rules governing common lodging houses and a stressing of the need for a proper water supply and co-ordinated fire brigade (16). The only practical outcome of this however was the issue of a notice from Frederick Marrable, the first superintending architect to the Board of Works, addressed to all builders, and announcing a more stringent inspection of hearths and flues by the District Surveyors. Three years later, another serious fire in Tooley Street (17) (see page 184), raised further doubts about the effectiveness of the Act, particularly with regard to the intercommunication of warehouses. At Beal's Wharf, buildings were connected without proper party walls, and, having been started under the 1844 Building Act and completed under the 1855 Act, they had apparently slipped between the controls of these Acts.

Anxiety was also felt over railway buildings following a fire at London Bridge Station, since these buildings were outside the scope of the Building Act, and the design for the new Law Courts in the Strand caused concern, since it was also exempt, yet was seen to contain a warren of chambers, flues and roof spaces (18). A Colonel Sykes proposed an amendment to the Building Act in 1862 in order to meet these aspects of fire, particularly restricting further the cubic size of warehouses, but the Bill was lost as time ran out in the debate as to who should have control of the discretionary powers it contained - the Home Secretary, the Police Commissioners, or the Board of Works (19). The subject was to reappear in August 1865. In the intervening period the Board of Works had itself produced another bill (20) but the growth of suspicion about the Board's activities seems to have prevented any progress (21). Mr. Locke attempted to bring in a bill to amend the laws regulating theatres (22) and it is worth noting, in passing, the appearance of the Metropolitan Fire Brigade Act in July 1865 (23). In August that year, a proposal from Colonel Blakely for an Ordnance Factory came before the Magistrates, since its volume exceeded the 216,000 cu.ft. limit.

The Colonel sought an adjournment, until the Board of Works had secured its amending Act to cover such buildings. The Bill was ready but, as the Magistrate pointed out, they had all waited year after year for such an Act. The marine boiler engineers had, as we have seen earlier, obtained their exemption, but the Ordnance Factory (and a Retort house for the Phoenix Gas Company) should, the Magistrate argued, press hard for an early amendment to the Act (24). But once again, the activities of the Board were under a cloud. A Select Committee investigated the working of local management in March 1866 and the appointment of a Royal Commission into the activities of the Board itself in June put an end to any further progress from that area.

It was then the turn of the Medical Officers of Health to take the initiative and their proposed bills came - and went - in the first half of 1867 (25). To these we shall return later in this chapter (see page 177). Following a Commons Select Committee enquiry into the provisions for the protection of property and life against fire in March 1867, William Tite, architect and Member of Parliament for Bath, introduced a bill in the Commons in August (26). But it also failed, as did a subsequent measure in May 1868 (27). The Building Act Committee tried again in December that year (28), this time with more success, it being passed in 1869 (the third of the successful amendments referred to earlier). In its wake, Tite brought in a more substantial bill in April 1870 (29).

This Bill extended the power of the superintending Architect to govern public buildings, in particular their safety from fire, and allowed new relaxations for wooden constructions, to the dismay of the District Surveyors (30). Building heights were set at a maximum of 60'0" in streets up to 40'0" wide and 65'0" in streets over that width and, amidst much protest from the commercial interests, a return to the 216,000 cu. ft. rule. The main opposition however came from the owners of timber yards, since the Bill now introduced controls on stacks of timber, which had to be no nearer than 25'0" to another building unless separated by a proper party fence wall, nor nearer the street than the building line (31). This, they claimed, would see the end of the timber trade in London, with consequent unemployment and distress (32). In the face of these protests the Board relaxed its rules for timber stacks, but at the same time introduced other rules which are important because it is

their first appearance in any proposed legislative measures - first, a damp proof course in slate or other impervious material, up to 1'0" above ground level, the second, a site concrete cover of at least 6" in depth (33). By June the bill had failed. "The Board of Works must be more careful next time", said 'The Builder', "this was not the first withdrawal, and such work costs money" (34). 1871 saw the amendment for the Foreign Cattle Market at Deptford (mentioned earlier) then, in 1872, another tentative bill appeared, this time dividing the sanitary aspects of the Building Act from the constructional aspects (35). This suggestion would appear to have come from Dr. Liddle (36), who saw the sanitary aspect coming under the Metropolitan Board, as a local health control, and the constructional aspects coming under direct Government control, at a more national level. The only outcome from 1872 however was the further relenting of the Board to the use of concrete under licence (see later page 191). All lay dormant until the end of 1873 when the Board of Works again proposed an amending bill (37). Its aim was to consolidate the Act, regulate streets, amend the building line provisions, introduce new provisions against fire and protective measures for the Board's sewers. The cubic size of warehouses went up to 220,000 cu.ft. and the timber regulations were reintroduced, though in a modified form. With its 111 clauses, based, as the Board said, on 18 years' experience, it was now hoped that this measure would meet all the difficulties of the existing Act: and consultations were held with all the parties concerned - the timber merchants, the builders and even, over the matter of heating pipes, the piano manufacturers (38).

Two unwise innovations, one to allow  $4\frac{1}{2}$ " thick party walls in certain circumstances and one to have 3'0" high parapet walls dividing houses were successfully opposed by Sir W. Codrington at the Board of Works before the Bill went to the Commons (39). The Bill was introduced by the Chairman of the Board of Works, Colonel Hogg, to the Commons in April 1874. The role of the Superintending Architect and the District Surveyors was extended and on technical matters the wall thickness rules were elaborated, although foundations, agreed by many to be too loosely controlled, remained as in the 1855 Building Act. Greenhouses, poultry houses etc, were now exempt, if over 10'0" from other buildings, as were w.c.'s if not over 25 sq.ft. in area and 7'6" in height. This latter concession was considered to be unwise - "they may be constructed of wood and brown paper" (40). 'The Times' noted "it is obvious that

19 years, during which London has in great measure been reconstructed, must have contributed a great deal of experience respecting the working of these Acts, of which it would now be desirable to take advantage" (41). Although Sir James Lawrence had asserted that the new Act would drive trade and manufacturers out of the City, 'The Times' considered that "in past times men have been allowed to build with a mere regard to their private interests in a manner which now involves material public danger" and it therefore welcomed the use of "sound principles of modern architecture and sanitary laws". "There is no excuse", it went on, "for omitting work of this purely practical character and a year now adds a formidable number of new buildings of London" (42). The Bill was read a second time at the end of April and a number of the more controversial clauses were removed including the one 'to prevent the disfigurement of walls and hoardings by large staring advertisements', a move which 'The Times' regretted, although it recognised that the reason for not pursuing it was that <sup>it</sup> would put a number of men out of work (43). Petitions for amendments came from the R.I.B.A. and the Dock Companies, both suggesting that the Bill go before a Select Committee enquiry, a move which was eventually agreed (44). The Select Committee, under Sir Seymour Fitzgerald's chairmanship heard evidence from many quarters. Mr Philbrick, Q.C., acted on behalf of the Board, outlined the history and working of the earlier Act, and maintained a stout defence of the new Bill (45). Captain Shaw of the Metropolitan Fire Brigade defended the clauses relating to fire-resisting buildings, but in the event, the Committee decided to remove all these from the Bill (46). The Royal Insurance Company naturally supported the retention of the 216,000 cu.ft. limit for warehouses, but then so did the architect Edward Barry. He felt it to be "scarcely an architectural question", although he was to support the limitation on building heights to 65'0" as a reasonable requirement "looking at the ordinary requirements of houses likely to be built under that rule". Robert Roumieu, the architect, was also in favour of retaining the 216,000 cu. ft. limit and made detailed reference to the building heights in Paris, which also appeared to average around the 66'0" height. Considerable discussion centered on the comparisons of building heights in London and Paris, as well as the vexatious problems of exemptions for railway buildings, building beneath the arches of railway viaducts and the proposal to prevent the support of structures by iron columns (47). To George Godwin, Editor of 'The Builder' the Bill was a move in the right direction, but it did not go far enough.

He wanted to see a layer of concrete under every building, a minimum height of 8'0" in a room, a damp proof course (what he called a drying course), a 6" deep ventilated air space under the ground floor and not more than one storey in the roof space. The Bill required a yard area of 150 sq.ft. - in line with the 1858 Form of By-laws (see chapter V, page 229) - and whilst Godwin welcomed this increase in area he had the satisfaction of pointing out to the Board a fault in the drafting of the relevant clause which would have allowed the yard area to be built over by buildings up to 3 or 4 storeys in height, provided they had a skylight. The pressures for this allowance were, as he noted, the "exigencies of trade" - but it had never been the intention to allow such abuse of the rule. Godwin also wanted to see further provisions to control building heights in relation to street widths, but he was prepared to accept the new warehouse rules, adding "a good party wall is worth all the fire engines in London" (48).

Further evidence to the Select Committee came from H.H. Collins, architect, from Benjamin Hannen and George Trollope the builders, from Dr. Ross of the St Giles Board of Works and also from Sir Sydney Waterlow M.P. As Chairman of the Improved Industrial Dwellings Company he naturally referred to the experience of his own buildings. The highest was a 65'0" high block behind Grosvenor Square. Soundly built of brick, with external staircases, he confidently felt that these buildings could safely go up higher, particularly if the mains water supply could reach that level. (At the time it was only available up to 70'0"). He also preferred a room height of 8'6" in his model dwellings. From Mr Donaldson of Gillow and Co., representing the timber merchants, came more protests at the cubic size of warehouses. They wanted at least twice 300,000 cu.ft.

To all these criticisms, Mr Philbrick ably defended the Board of Works' new Bill (49). The Committee retired to consider its findings, and its report appeared in July 1874. They considered that it was not desirable to fix any limit on the height of new buildings in streets over 50'0" wide; not desirable to limit the cubic content of buildings except warehouses, and in buildings used partly for storage and partly for retail, the portion used for storage was to be regarded as a warehouse, and to be subject to the controls set out in the Bill. Interestingly, in the light of future legislation, they also proposed

to keep the old language of the existing legislation in order, as they put it, "to avoid new questions arising".

The Editor of 'The Builder', who had himself given evidence, was very disappointed at the outcome. The amendments were not basic and it seemed doubtful if the Board would relent or change its tactics. "The inference can scarcely be avoided" he wrote, "that the Building Bill will not be passed this session" (50). His inference was to be proved correct. Although the Board's Building Act Committee amended its clauses on the height of buildings in streets over 50'0" wide as well as the cubic size for warehouses, the Board itself would go no further with the modifications. Consequently, in the face of this defiant attitude, the Parliamentary Committee decided that it was "not expedient" to proceed any further with the Bill (51). So, in the year of the Public Health Act, 1875, London's building still laboured under a Building Act passed twenty years earlier.

\*\*\*

In matters regarding the Building Act the principal spokesman for the medical profession in London appears to have been Dr. Liddle, the Medical Officer for the Whitechapel district. He addressed the Metropolitan Association of Medical Officers of Health on 'The defects in the sanitary provisions of the Building Act in December 1861' (52). His main contentions were the provision of space for house ventilation and the constant evasions of the Act by the builders. He went further however, suggesting that room heights be 8'0" throughout, window sizes be stipulated, damp proof courses be required, escapes incorporated in public buildings and, his own notion, the provision of parapet walls to prevent snow and loose tiles falling from roofs. Four years later he was still demanding the inclusion of the same matters, noting the glaring fault in the Act which, whilst calling for 100 sq.ft. for the yard, allowed it to be of any proportion - it could be 1'0" wide by 100'0" long and still comply (53).

In January 1866, the Medical Officers made representation to the Home Secretary, calling for amendments to the Act on the lines indicated above, but with the following additional requirements : plans to be submitted to the local authority showing the means of ventilation and

drainage and the precautions against damp. No foundations or drains were to be covered in, they suggested, until they had been inspected and approved by the local authority, and the authority itself was to have power to regulate the area of the yard for ventilation, either at the rear or side of the house (54).

At the end of the year, the energetic Dr. Liddle was again on his feet addressing the Metropolitan Association of Medical Officers of Health. He urged that a deputation be sent to the Board of Works, since he considered all current sanitary legislation to be "a perfect mockery". "No attempt had really been made to make the local authorities responsible for sanitary defects" (55). A deputation duly went to the Board's Offices in Spring Gardens, armed with a bill of its own making. In it they proposed that every street should be effectively drained before any houses were built, that there should be no building on the 'open' area, that buildings should not be built in a piecemeal fashion, that room heights should be 8'0" minimum, the size of windows be regulated, w.c.'s planned in the best position and the foundations planned to prevent rising damp. The Bill was referred to the Board's own Building Act Committee (56), but it was considered to be defective and it was returned to the medical men (57). No more was heard of it - it was far in advance of its time.

In February 1870, the Medical Officers again wrote to the Home Secretary, asking for tighter controls in house construction. Many of the previous matters reappeared, with the additional requirements for glazed drain-pipes, a ban on the re-use of old bricks (which were often taken from cesspools) and a control on the quality of mortar (which was sometimes simply made from the road sweepings). The 8'0" room height, with the proviso that in the attic it should apply over not less than half the area of the room, and the need for openable windows in all habitable rooms was again reiterated. As for the yard area, they now suggested 100 sq.ft, with a minimum distance of 15'0" to the opposite building if the house was two storeys high, 20'0" if three storeys high and 25'0" if more than three storeys. In this they were now following the principle of the same regulations in the 1858 Form of By-laws (see chapter V, page 228), except the minimum area in the by-laws was 150 sq.ft.(58). Certain of these suggestions from the Medical Officers, specifically the oft repeated need for a layer of site concrete and



a damp proof course, were incorporated in the abortive Bill of 1870.

December 1871 saw the indefatigable Liddle yet again calling attention to the defects in the Act, particularly the matters of air, light and ventilation. He recommended that any new bill should include a space at least 20'0" wide at the front of every new house, and 100 sq.ft. at the rear, and it was at this time that he made the suggestion we have noted earlier, for dividing the sanitary clauses from the constructional clauses and moving them to different areas of administrative control (59). It is interesting to note that we have here one medical expert reversing the opinion of another - since it was Southwood Smith, some thirty years earlier, who suggested the incorporation of sanitary controls into the Building Act.

At the Social Science Association meeting in 1873, Liddle suggested some further improvements. A proper sewer in the street, with a ventilated drain from the house to the sewer was proposed. He had the support of Mr. Iron the Whitechapel Surveyor, who suggested (possibly the first instance of this) the carrying of a small pipe from the upper part of the soil pipe to a point clear of the house roof. Then Liddle proposed a w.c. or privy within the curtilage of each house, not outside in the court, proper foundations and a damp proof course and open space to secure thorough ventilation of the stairs and passages, with a through passage from the front door to the backyard and a landing at the top of the stairs. This was to prevent the front door opening straight into the sitting room and the stairs coming straight out of the lower room "so that the foul air of the lower room is ventilated by means of the staircase into the room above" (60). Underfloor ventilation and Liddle's private campaign for the parapet wall were repeated, but of rather more significance was the recognition that the penetration of sunlight should be facilitated by controlling the height of the building in relation to the width of the street. The recommendation was for the height of the building not to exceed the width of the street. And then, besides these technicalities, there was the suggestion that the Building Act should be made to apply to all the towns in England (61).

In the discussion that followed Liddle's lecture, Edwin Chadwick put forward his view that architectural construction and sanitary construction

were two different things and that 'sanitary science' had not yet been 'conjoined with architectural art and practice.' He recalled how, soon after 1842, he had been requested to join a committee of 'first-class' or 'palace architects' (as he called them), in order to frame a new Building Act and how he had excused himself from it, their 'regular doctrines' and 'fixed opinions' being so completely at variance with his own views. (That he had his own 'fixed opinions' was not mentioned). Yet unlike Liddle, he believed that the control of building structure and sanitary control should be under one overall authority, not divided between the building surveyor, the road surveyor and the drainage surveyor. Baldwin Latham agreed with this, adding that the single control should be made to operate in many large towns outside London as well. Local by-laws were, he argued, totally ineffective and what was really necessary was a new, national, Building Act. Liddle added that there was a worse absurdity, where different and distinct Acts referred to matters that were substantially the same - "to build a house a person must consult half a dozen Acts" (62), a situation not unfamiliar even today.

After all the strenuous efforts of Liddle and his colleagues, 1874 brought no result. They were aghast at the Bill of 1874, seeing it as a highly imperfect measure, ambiguous and full of defects. There was nothing they had asked for, nothing to ensure proper light and ventilation, nothing to prevent back-to-backs; it did not even require a house to have its own backyard, nor its own w.c. and drainage. "A bill more deficient in wise proposals and altogether more impotent" Liddle maintained, "it was difficult to conceive" (63).

\*\*\*

The Institute of British Architects was a little slower off the mark. In the early years of the Building Act's operation, it seems to have concerned itself more with the finer points of its examination for the District Surveyors (64), rather than with any more fundamental matters. But by 1862, when Henry Roberts gave his talk on 'The essentials of a healthy dwelling' at the Institute, it was George Godwin who opened the subsequent discussion and brought the matter round to the Building Act. He sincerely hoped that it would be amended. "The only three provisions of the Metropolitan Building Act framed for the preservation of the

public health - those related to cellar dwellings, rooms in the roof and an area of 100 sq.ft.behind each house not wholly lighted from the street - are in practice inoperative". (65). Rooms in the roof could be called luggage places, not sleeping rooms, if their ceiling height was too low, cellars could only be checked by official inspectors at certain times during the day, when, naturally enough, they were not occupied by the sleeping tenants. As for the 100 sq.ft.of open yard, cases of evasion abounded - in one instance even a District Surveyor had been suspended for allowing two rooms to be linked by removing the door and allowing them to both be lit from one window only - yet it was quite within the terms of the Act, but far from its original intention (66).

At the Architectural Association the mood was similar, but the Act received some support. C.J.Adams, in his paper on 'The Metropolitan Building Acts 1666-1856', given to the Association in January 1864, was principally concerned at the problem of the exempted building - Her Majesty's Theatre in Haymarket being 'a suitable object for legislation in any improved Building Act". But Professor Kerr, whilst emphasising the administrative weaknesses of the Act, maintained that "the whole of the practical portion of the Act was contained in a few chapters which any person of average abilities might master in the course of a single evening". One speaker felt that the great drawback was the "difficulty of construing it, owing apparently to the desire of the legislature to make it as brief as possible "whilst another considered it a most excellent Act - although he was prepared to concede that there ought not be any buildings exempt from its controls (67).

The R.I.B.A. met to discuss the merits of the 1868 amending bill in January 1869. They noted that many of its provisions seemed to have come from the Liverpool Acts, particularly regarding fire-resisting buildings and warehouses, but on the matters of light and air, matters they had themselves proposed, there was nothing. This Bill, pared down, was to become law in 1869 - with the principal effect of simply transferring the powers to control dangerous structures from the police to the Board of Works. Sir William Tite, now President of the R.I.B.A. referred to this Bill in his presidential address in November that year. He reported that although the Committee at the R.I.B.A. had considered it carefully, it had been agreed to "leave well alone" and although some

changes were perhaps required, it was felt that "on the whole, it would work well" (68). It was rather typical of a conservative profession, and something of a contrast to the medical officers, but then Tite was in a position to see the wider business aspects and preferred to operate with caution.

At the Social Science Congress in Norwich in 1873, the architect H.H. Collins delivered a paper on the defects in the Building Act (69). He confined his comments to houses only, considering 'stability of construction', 'hygienic construction' and 'aphlogistic construction'. Stability called for a clearer definition of foundations, the removal of loose or made ground, and a specified thickness of concrete over the site, and effective land drains. The sizes of walls and footings should be specified, depending on the purpose of the building (a sensible proposal, if it had been developed scientifically), a damp proof course should be inserted at a height of 12" between the wooden floor and the top of the footings, and ventilation was required under the floor. The proposal for a damp proof course at the top of a parapet wall was a reinstatement of a requirement in the 1844 Building Act and a minimum thickness of 14" for all walls to prevent damp penetration was also included. There was no mention of a cavity wall.

Under sanitary construction, Collins suggested that a w.c. should be provided in all cases and that it should be ventilated, away from windows - and chimneys. He disapproved of rainwater pipes being used as vent or waste pipes. The space of the backyard should be at least 10'0" in depth, running the whole width of the house, which would give often a larger area than 100 sq.ft, and stop any form of back-to-back development. Room heights were to be at least 8'0" everywhere, and public buildings should have better provisions in case of fire with more exits, doors opening outwards, no stone stairs and a continuous water supply to a fire main. Exemptions to the Acts were deplored. As Collins said, with some effect : "The result of permitting these exemptions cost the valuable life of the Prince Consort and nearly deprived this country of that of the Prince of Wales".

The Bill of 1874 was considered by the R.I.B.A. To their horror, they saw that the Board of Works could now approve any material 'from time to time' as fire resisting - "even felt, brown paper or canvas". Part

III of the Bill required wrought iron framed fire resisting doors to be filled with concrete and rendered - a requirement which was "quite incomprehensible" to the R.I.B.A. They had wanted to see the rules officially amended to allow the backyard to be used as an extension to a shop or warehouse, provided it was not used for sleeping and provided it had a skylight. No concessions could be found there in the Bill. Then there were some structural matters which required correction - but in all, the R.I.B.A. felt that it was probably better to keep the old Act and amend it, rather than attempt to draw up an entirely new measure which the 1874 Bill virtually set out to do (70). The President of the R.I.B.A., Beresford-Hope, petitioned for a Select Committee enquiry in the House of Commons (as mentioned earlier, page 174), and this was duly established (71). A special meeting was held at the R.I.B.A. on 11 May 1874 to discuss this Bill. The resolutions passed by the meeting included the limitation of the restrictions to matters of public safety only - since some would appear to have restricted the development of the value of property - an improvement in the definition of terms in the Bill, greater attention to fire-resistance and controls to prevent the Board of Works being given too much freedom (72). This Bill expired, as we have seen earlier (page 176). Sir Gilbert Scott, in his presidential address to the Institute in November 1874 (73) summarized the R.I.B.A.'s objections to two points - too full and arbitrary powers being granted to the Board of Works, and a reduced authority to the District Surveyors (many of whom were, of course, architects). The resistance of the Board of Works to any major modifications, such as the Select Committee had heard in its evidence, brought about the downfall of this Bill.

There the matter must remain in 1875, until the account is resumed in Chapter VII. We now turn in this second half of this chapter to consider the working of the 1855 Building Act in the face of its three main areas of public concern; fire, structural stability and health, commencing, as in the pattern of Chapter II, with fire.

\*\*\*

The 1855 Building Act in Operation in London      Fire

From a wealth of evidence concerning fires and their causes in buildings

during this period, it is possible to select and group certain examples which have a direct bearing on building regulation, and to divide this section into two : the first part being principally concerned with building types, the second with building elements and materials.

Fires in theatres and other places of public assembly inevitably drew the concern of the public towards the state of control over the safety of these buildings. In fact there were no specific controls for theatres, although being classed as public buildings they were subject to section 30 of the 1855 Building Act and to the approval of the District Surveyor.

The Covent Garden Theatre burnt down in March 1856 (74), aided by the extensive use of 'bond-timbers' in the walls; six died in a fire panic at the Surrey Music Hall in October the same year, the victims being caught on the narrow treads and winders of the stairs and against an inward opening door at the bottom (75). That was the first year of the Act's operation, and unfortunately the year saw a succession of similar disasters. The enforcement of what controls there were was frequently ineffective. For example, when the builder who was converting the old Marylebone Theatre into the new Royal Alfred was summoned in 1863 for using combustible materials for the floors and galleries, he defiantly claimed to have done the same at both the Queen's and Holborn Theatres, with no objections being raised by anyone. He knew of the Building Act, but insisted that he was doing nothing more than simply replacing old material with new, which was legal - and he persisted in his work, the rebuilt (but greatly extended) theatre being opened to the public a short time later (76). It was the vigilant Dr. Liddle in 1861, in one of his frequent attacks on the shortcomings of the Act, who said:

"In preparing a new Building Act, it would be very desirable to make provision that all buildings intended to be used as places of public entertainment should have a sufficient number of doors to allow the speedy exit of the audience in case of alarm of fire" (77).

A little earlier 'The Times' had noted realistically however that

"no architectural ingenuity can construct a building out of which everybody can escape at the same instant of time, and the chief uses of devices to effect this is that by increasing confidence, they diminish terror. The real enemy is panic itself" (78).

Dr. Liddle repeated his demands in his report on the health of the Whitechapel district in 1865.

"Neither is there (in the Acts) any provision made to afford safety to the public in enabling them to make a speedy exit from places of public entertainment in case of alarm of fire" (79).

The nearest the legislation had come to meet this problem was the Bill prepared by Mr. Locke in April 1865. Although it did not survive beyond June that year, it had set out detailed dimensions for doors and corridors in relation to the size of the audience, required unobstructed gangways, doors to open in the directing of the exit flow, and limits to the location of gas lights in relation to inflammable materials (80). This latter point, and the general increasing use of gas lighting, was a development totally unforeseen by the 1855 Building Act. As a District Surveyor wrote in 1870,

"The invention has come into use since the date of the Act and the clause which is supposed to apply (as to pipes conveying heated air) is really directed at nothing of the kind" (81).

The particular invention the Surveyor had in mind was the elaborate 'sun-burners' manufactured by Messrs. Strode and Company. They jealously guarded their product and were quick to point out that sun-burners had been used by Charles Barry in his Reform Club as early as September 1852, but more to the point, if the District Surveyors felt that the clause he had quoted was not applicable, "where was his authority for any interference at all" (82). Strodes, proud of their product, did not want to lose trade through the quirks of the building regulations.

The second building type to be a major fire hazard was the warehouse. Here the most catastrophic disaster was the fire in Tooley Street, Southwark in June 1861 - the fire incidentally in which the authority on fire, James Braidwood, lost his life. The fire destroyed three acres of warehouses, with a loss of over two million pounds. Blame was laid on the insufficiency and ineffective application of the Building Act, allowing as it did buildings, such as those at Beal's Wharf, to freely interconnect without proper party walls. At Hay's Wharf, party floor arches supported on cast iron stanchions and girders, had been thrust out in the heat and had collapsed, although this was later denied by the architect for the building, one William Snooke. Amongst the succession of suggestions which followed the disaster, there were those from Robert Hesketh, District Surveyor, calling for iron shutters for doors and windows, sliding iron doors between compartments (to allow for expansion in the heat of a fire), isolated stair wells and fireproof floors (83). Charles Henman had suggested a 15'0" wide

separating zone between warehouses, with full water tanks situated over this zone, to supply hoses running to the adjacent warehouses. The hoses would be self activating, with a fusible plug; in other words, our modern sprinkler systems (84). Liddle put forward a similar proposal at the same time, 3" diameter pipes with slits in them to spray the stored merchandise in a fire (85). Another early experimental idea was that of fire ventilators in warehouses. One C.F.T. Young raised this in May 1866. It was contrary to Braidwood's principle of preventing draughts so that the fire might extinguish itself, but Young thought that roof openings to let out the heated air and smoke should be tried, even if it was difficult to do technically (86).

It was possible under the 1855 Building Act for warehouses to be as close as 6" together - although still legally 'detached'. In allowing this, Hesketh said 'The Act had done more mischief than it had done good' (87). That was 1861, but in Liverpool they already had a more stringent act (88) which Braidwood had enthusiastically heralded as a model five years earlier (89). There the size and height of warehouses were restricted, party walls compulsory, all doors and windows were to have iron shutters and the space between warehouses was set at a minimum of 36'0". The fact that this Liverpool Act was retrospective was very rare and was to apply, in theory at least, to warehouses already built. Some parts of this Act were to influence the framing of the London amending Bill of 1869, as mentioned earlier, but in spite of this, no major changes were made to the warehouse regulations, other than for the marine engineers, between 1855 and 1894.

'The Times' referred in 1861 to the conspicuous failure of fireproof buildings:

"The workshops of Mr. Philips, where 'Fire Annihilators' were made and which burnt down .... the machines in course of construction being taken at an unfair advantage. But there was no excuse for Cubitt's factory in Pimlico, or the new wharves at Tooley Street. Is there no virtue in metal columns and girders, metal doors, metal penthouses, and all the resources of anti-Vulcanic architecture? We doubt it very much, at least when the fire originates from within . . . . the art of fireproofing is analogous to water proofing which furnishes a complete protection against external moisture" (90).

Six months later 'The Times' added:

"Perhaps some alteration in the Building Act may be necessary to prevent the recurrence of those acres of flame which we witnessed six months ago (in Tooley Street), but against ordinary risks, both public and private, a public establishment of fire engines and firemen ought to



be sufficient" (91).

The Metropolitan Fire Brigade Act was however still three years away (92).

A third building type - if it could be called a building - was the timber stack in the timber merchants' yards. That they needed control was clear:

"Whilst wooden window frames had to be 4" within the face of a wall, hundreds of builders yards, like Messrs. Trollope and Co's, could be stuffed with timber 'ad libitum' without any Act compelling or authorizing any interference whatever" (93).

Proposals for controls for these stacks occupied the majority of the Bills up to 1873, in spite of considerable protest from the timber merchants, but no such amendment passed into law within this period.

One final and relatively minor point, but one which needed to be resolved, was the ruling that railway lines were to be treated as public highways for the purposes of the Building Act. In 1869, a Mr. Brown of the Railway Tavern built three timber sheds on a piece of land bounded by the London Chatham and Dover Railway, and by Nunhead Cemetery. Whilst "no spark was anticipated from one of these neighbours" the Magistrate ruled that the other was a public highway and that the controlling distances of the Act should therefore apply (94).

\*\*\*

Considering now the performance of certain elements of a building and materials in a fire, the most critical element was the staircase. For years wood had been assumed to be totally unsuitable - it was so obviously combustible, and the alternatives of stone or metal for stairs were encouraged. 'The Builder' went so far as to propose that if these more expensive materials of stone or metal were used, an incentive might be offered by the Insurance Companies to reduce their rates, thereby compensating to some extent for the greater capital cost required initially (95). The same journal repeated its support for the isolated circular stone stair - the Scottish turnpike stair, and for independent iron stairs and horizontal galleries, such as those made by Mr. Allen of Shoreditch (96). In 1865, however, Captain Shaw (Braidwood's successor at the Fire Brigade) spelt out clearly the danger of using stone for stairs:

"Stone was in no sense fire proof. It expanded in a fire and contracted under water, causing splitting and was liable to fracture near the wall. That paragraph (sect 22) in the Metropolitan Building Act has done incalculable injury .... a compulsory law based on a grave error. Stone stairs collapse, when wooden ones remain" (97).

'The Times' noted this change when, in referring to the Select Committee enquiry into the protection of life and property against fire in 1867, it said:

"it appears too as if some of our notions of fire proofing were altogether mistaken, for the Committee was assured by professional witnesses that iron was of little use in stopping the progress of fire, and the wooden stairs were rather safer than stone" (98).

It was at the Architectural Conference in 1871 that Charles Fowler introduced for the first time the term 'fire-resisting' in his paper 'Fire resisting materials, with reference to the Building Act'. In all earlier legislation the words 'fireproof' or incombustible had been used but, as he pointed out, with the possible exception of brick arches on brick piers, there was no such thing as 'fireproof construction'. Amongst the list of materials which he listed, as fire-resisting for the new Bill, wood was now limited to oak or other hardwood for beams and columns, used if necessary with wrought iron protected by plaster - and this was the only reference to iron in any form, cast iron not being mentioned now at all (99).

There were two further parts of the building to cause concern with respect to fire and the Building Act : hot water pipes near timber, and chimneys and flues.

The matter of steam or hot water pipes, though more elaborately set out in the 1855 Building Act than in its predecessor of 1844, was still a cause for controversy. Did such pipes set fire to timber? Some felt convinced that they did, others felt equally convinced that they did not. The following examples show the range of the debate.

Soon after the Act was passed, the case was heard (in 1856) of the pipes for hot water heating in St. Paul's Church, Deptford, which were placed closer than 3" to the pews. The builder said that the temperature in the pipes would not exceed 212<sup>o</sup>F and that wood would not char below 500<sup>o</sup>F. The Magistrate lost track of the proceedings and ruminated on the purpose for which the pipes were used, rather than the actual heat they produced, to the dismay of the District Surveyor who reminded him that the matter had been fully discussed before a

Commons Committee and besides, the pipes might be used in the future to convey "dry heat" at a much higher temperature. All this the Magistrate was finally persuaded to accept and the unfortunate builder had to re-position the pipes (100). On the other hand, and in the same year, Frederick Marrable, in a discussion on Braidwood's paper to the Society of Arts on 'Fires and fireproof buildings', refused to accept Braidwood's fears of hot water pipes being nearer to timber than 3". "No 'chemical action' he said, 'tookplace between heated iron and wood, only wood reached a state like touchwood" (101).

Ten years later, in 1866, the pipes in a church at Sydenham were found to be only 2" from the timber, and the builder was duly summoned. The Magistrate's conclusion this time however, was that:

"the notion that woodwork would take fire from the heat of hot water pipes was preposterous. Further, if the Act was strictly enforced, it would be impossible to have the luxury of heated pipes in a gentleman's bathroom" (102) - case dismissed.

But 'The Builder' cautioned its readers, reminding them that buildings had been set on fire by hot water under pressure: "we have ourselves lighted a common brimstone match on pipes full of water from a close boiler" (103). A 'Hot Water Engineer' reaffirmed that it was indeed only 'high-pressure' pipes, hermetically sealed, which were dangerous, and he felt sure that these were what Mr. Braidwood had had in mind when formulating the clause in the 1855 Building Act. Ordinary cast iron pipes were, he added, not dangerous. (104) But still not everyone was so convinced. A small fire in a shed in Kensington in 1871 was caused, it was said, though not proved, by the hot water pipes. Triumphantly, a gentleman signing himself as 'Y', wrote to 'The Builder': "Often this notion has been laughed at, but this shows how necessary it is" (105).

The rules governing chimneys and flues was somewhat obscure, particularly with regard to the size of flues - no longer mentioned in the 1855 Building Act, as they had been in the 1844 Act. Since the 1844 Act was now repealed, did this mean that the requirement of the 1840 Chimney Sweepers Act, with its 14" x 9" flue size, now applied to London, as it did to the rest of the country? No-one seemed to be sure, but it was clear that the old rule was largely ignored. 'An Architect' wrote in 1875:

"I have no objection to confessing that, in days of youthful innocence, I drew my own conclusions on remarking that plans of cottages for Labouring Classes had often to be adorned with flues of square section,

instead of the more fashionable and cumbersome 14" x 9". The line of smoke, in harmony with the lowly station, seemed to me all too clearly prefigured by the exiguous preparation for its exit. And, not to dwell longer on the past, cannot many people remember the violation of the letter and spirit of this enactment at times by not inconsiderable designers of buildings?" (106).

Narrower flues were found to be quite satisfactory. There was George Jennings, writing on 'Structural improvements and Healthy Homes' in 1862, using a patent system which needed flues of only 7" or 5" diameter - and even 3" diameter had worked well (107).

But in 1875, Lord Shaftesbury wrote to 'The Builder' to draw attention to an Act of 1875 (108) in which it was proposed to retain the 14" x 9" flue size, minimum flue angles at 120° (unless there were proper soot doors) and chimney stacks at 4'0" in height (the same as Liverpool, but a foot higher than in London). This area of control was obviously in some confusion. As the Editor of 'The Builder' said: "Considering that the Metropolitan Building Act gives certain instruction on this, we have here a pretty specimen of our mode of bit by bit legislation with divided responsibilities" (109).

\*\*\*

### Structural Stability

In spite of the brave attempt made by the 1855 Building Act to control construction, the actual standard of much building, particularly in the area of the cheaper houses, was, even in the mid-century, still appallingly bad. The builder of four houses in Rotherhithe in 1863 produced the worst work that a District Surveyor had ever seen: "In a 24'0" length of party wall, not one whole brick was used and the whole wall was held together by soap lees, small limestones and dirt" (110). "There were many places in the Metropolis where buildings were erected with bricks you may stick your finger or the point of your umbrella into" remarked Philbrick, the Q.C. acting for the Board of Works in 1874; and George Godwin had added "throughout the suburbs hundreds of houses are built on the grass. Builders very often take the sand out from the site of the house for the mortar, and then fill up the hole with even night soil" (111). It was optimistically hoped that the law could be brought to bear more closely on the builders. A Surveyor wrote in 1862: "An amendment is very much required whereby

the responsibility of evasions of the Act and other irregularities should be affixed to the real culprits - the builders" (112). And 'The Times' wrote:

"One difficulty is the character of the British Workman. He is not to be trusted where the eye of man is no longer upon him. He does unseen work in plausible fashion, laying the drain so that it chokes itself, placing the pipe where it is sure to burst, and making his chimney so that, as likely as not, the fire will catch the rafters and burn the house down. Many a sad experience suggests the question whether it would not be possible to place quite within constant observation and easy control every arrangement whatever from the top of the house to the bottom for sanitary purposes" (113).

But it was clearly impossible to frame any legislation, in the days before standards, codes of practice and organised training, to control effectively the many aspects of construction and the quality of workmanship.

If the Act was not particularly effective in preventing bad construction with traditional materials, then neither was it sufficiently broad in its controls to allow new developments in materials. Whilst one Magistrate was prepared to allow a straw roof to the Ice House at the Crystal Palace (114), the use of asphalte on roofs was, as in earlier years, still something of a problem. One Magistrate conducted an experiment for himself in the fireplace at the Police Station. The asphalte flared away, as a constable who was present remarked "like a candle", but it instantly went out when it was withdrawn from the fire. The Magistrate was baffled, unable to say whether the asphalte was combustible or not within the meaning of the Act, and dismissed the Summons, having fortunately found a minor technicality elsewhere (115). A succession of similar test cases gradually proved that the material was, at least, less combustible than some of the other materials listed in the Act (116) and by 1870 it appears to have been generally accepted. Indeed, it reached a high level of respectability in that year: Lucas Brothers were using it on the roof of the new Albert Hall, where "it promises to make a capital job" (117).

Hollow, that is, cavity walls, were, according to Godwin both "drier and warmer than solid walls of the same cost" (118), and Chadwick also favoured them: "A hollow 9" wall was warmer than an ordinary 18" brick wall, while at the same time it was non-conducting" (119) - presumably of moisture. The requirement in the 1855 Building Act for the wall to be 'solidly put together' effectively prevented the use of the cavity

wall, and it likewise held back the development of concrete walls. The key words in the Act were "properly bonded and solidly put together", and to the Metropolitan Board and the District Surveyors this could not be interpreted as allowing concrete. Although Godwin, himself an early supporter of this material (120), saw no objection to its use in walling, the general body of opinion opposed the pioneers. The campaign was led by Joseph Tall, a contractor who had already built houses in France for Napoleon III, using a patent shuttering system, but he was to have an uphill struggle to win acceptance for the material in London (121). Leases for patent concrete systems were reluctantly granted in 1868 and 1872, but no major changes were made to the legislation during the period. The R.I.B.A. took a keener interest in the material towards the end of the period (122), but the final recognition of the material by the London by-laws did not come until 1886, and remains for a later chapter. (see page 352).

Concrete was however allowed in foundations, as an alternative to a solid rock base, but, as Godwin pointed out, the Act did not say what must be under the concrete, nor of what thickness it was to be laid (123). Professor Donaldson remained content to leave this matter to the judgement of the District Surveyor, though he agreed with Godwin, that a layer of concrete should cover the entire basement area of a house (124). Collins, in his paper on the defects of the 1855 Building Act, had sought a more accurate and consistent definition of a 'foundation', together with a requirement for "all loose or made ground to be removed until a firm solid bottom on virgin ground can be obtained". He further proposed that all walls and footings should be "erected of certain dimensions, varying according to the purpose for which the building was intended" (125) - a more scientific approach, but one which, with the knowledge of the time, could not be properly undertaken.

Associated with this lower zone of the building was the damp proof course. This had been mentioned earlier, in the discussions preceding the 1844 Building Act. Now in 1857 one 'T.B.' had suggested that the floor joists be set 2'0" clear of the ground, with slate or lead underneath the wall plate "to prevent damp rising - and rheumatism". (126) Dr. Liddle had also urged that a means of preventing damp in walls be included in a Building Act in 1861 (127), and Godwin had referred

to one of the many patent devices then currently available - Taylor's damp proof course : "an elongation in vitrified earth of the ordinary air brick" (128). The Medical Officers had pressed the matter again in 1866, to no avail, but it was possibly the evidence that John Bailey Denton, Engineer of the General Land Drainage and Improvement Company, presented to the Royal Sanitary Commission in 1869 which had more impact. The 'code' he composed himself included the following : "all walls should be built with a damp proof course above the ground line, to prevent the rising of moisture within the walls above ground" (129). This suggestion was duly recorded and included in the list of amendments in the Commission's final report two years later (130). In the intervening year, 1870, the proposed amending Bill had included the following:

"every wall of a dwelling house shall have a damping course, that is to say, a course of slate laid in cement or other material impervious to water, at a height not exceeding 1'0" above the outer ground surface or the top of the footings, whichever is the higher .... the ground surface or site of every dwelling house where not flagged over, shall be covered with good concrete at least 6" in thickness" (131).

This appears to be the earliest clause framed to cover this matter, though at this stage the damp proof course was set at a maximum of 12", by the time of the Model By-laws of 1877 it had been changed to a minimum of 6". In 1873, Collins was still referring to 12" between the joists and the impervious damp course. He mentions again the need for legislation to prevent damp penetration at the top of walls : "the walls should be covered at their termination with a material impervious to wet" (132). The need for the damp proof course was supported by both Godwin in 1874 (133) and Ross in 1875 (134), as well as the need for a site cover of concrete. This latter point was taken up by P. Gordon Smith, the architect to the Local Government Board, who wrote to 'The Builder' in 1875: "numerous sanitary authorities were framing building regulations" (and it was) "a suitable time to remind them of the idea of covering the ground within the building with a layer of concrete or asphalte" (135).

Moving upwards from the foundations and damp proof course, the next area of concern was the walls themselves. The phrasing of the 1855 Building Act allowed alterations or additions to a building to be subject 'only to the extent of such alterations', as far as the Act applied. It was possible therefore, in theory, to build a house with walls of the proper thickness, roof it over (thereby 'completing' the building),

then remove the roof and add two or three further storeys, all supported on the original walls below (136). John Todd put the theory into practice at No. 5, Thurloe Place, Brompton, in 1858. He removed the original roof, added further storeys, with one in the curbed roof, thereby increasing the height of the walls from 50'0" to 58'0". The Act required part of a wall up to 58'0" to be 17½" thick, but the original lower wall was only 14" thick - and it was allowed to remain so (137).

The most controversial feature of the wall thickness controls was the allowance of 9" walls in the upper storeys of houses. As Collins said in 1873:

"In this variable climate it was impossible to keep out humidity and cold with such a thickness, more particularly with the absorbent nature of the materials at command, and the upper storeys, mostly inhabited by children, were especially most subject to driving rain. Walls should not be of a less thickness than 14" (138).

However, one may note in passing that the Manchester by-laws of 1867 allowed 9" for all external walls, and 4½" for party walls, a considerably lower standard than London.

One Scamozzi Smith, writing from a fictitious "Shakespeareia" to his friends in London, talked of a 'City of the Future', setting the date at 1915-16, and foresaw the following:

"Bad building has been saved by a very stringent Building Act. The lowest class of houses are as well and as substantially built of their kind as those of the highest. The walls too, of small houses, are not made of a thickness merely proportional to the height and extent, but they are made of a thickness sufficient to equalize the temperature. No human dwelling for example, must have its external walls less than 1½ bricks thick at the top, with proper increase in foundations, and no division wall between the smallest houses less than the same thickness - if of stone, 2'0" thick. Should this thickness of party walls to the smallest houses seem to you excessive, bear in mind that privacy and security from spread of fire from house to house is at least aided by it" (139).

In spite of such optimism, in reality the Model By-laws of 1877, following the London standard, retained 9" in parts of its wall thickness schedules.

The limitation of openings and recesses to a maximum of one half the external wall area was seen as a severe hardship - particularly for workshops where ample light was required (14). Within a year of the passing of the Act, it was said that the District Surveyors in the



City had abandoned any attempt to conform to the rule:

"Shop fronts they must leave out of the calculation altogether (although there was some confusion over this point) and in the case of say, carpenters' workshops, how can they insist on compliance with the clause" (141).

A block of new offices in Fenchurch Street were described as being 'three-quarters openings', although Edward l'Anson, the architect for the building, insisted that the clause had been complied with (142).

A District Surveyor attempted to clarify the clause as follows (although with not too much success):

"It is only to prevent any recesses being made in a wall when the openings exceed one half of the whole area of the wall. The words are 'taken together', and any other interpretation would prevent any windows being made in the upper storey of a house when the whole ground floor was a shop front, and there was only one storey above of less height than the shop" (143).

There was discussion on this matter when the Select Committee considered the amending Bill in 1874, since the Bill proposed brick piers to support the superstructure in cases where the external openings were greater than half the total wall area - a measure intended, so it was said, to reduce the dependence on iron columns - and one which received the support of Edward Barry (144).

The warehouse builders found a number of ways of avoiding the party wall requirements of the 1855 Building Act. The Act itself contained loopholes and conflicting definitions (145). One example of a legal evasion was the rebuilding in 1862 of Alderman Humphrey's warehouses at Hay's Wharf, scene of the Tooley Street fire. It came to be 500,000 cu.ft. without any party wall, simply because it was held to be a 'rebuilding', the main walls having remained intact after the fire (146). Evasions were also made to the requirement for party walls to run through and beyond the roof. A building near Charlton Church was converted in 1867 into four tenements as almshouses for old married couples. The builder did not take the walls above the roof, claiming it was a 'hospital' or public building, and, as with the precedent of the Peabody Model Lodging houses, they were not required and "would destroy the harmony of the elevations" (147).

With regard to roofs, the development of the high curbed or mansard roof had not been anticipated by the 1855 Act - those "portentously high mansard roofs which are at present such a feature in all exhibitions of architectural drawings "as they were described in 1870 (148). The

amending Bill of that year had proposed to re-instate the limitation to only one storey in the roof, at which 'The Builder' commented "some of our warehouse and hotel designers will be shorn of the strength residing not 'in their hair' but in their roofs, by this Delilah of legislation" (149). In Liverpool however, the year before, the local architectural society had remarked that the prohibition of more than one storey in the roof would probably be omitted from the proposed amendment to the Liverpool Building Act -

"the introduction of the Mansard or French roof having shown that such a provision is undesirable, a reference to some Gothic edifices would furnish similar and earlier precedents. It is one of the provisions of the Act now in force which has been violated with impunity" (150).

Aesthetic pressures, in both cities, would appear to have eliminated the rule requiring only one storey in the roof.

The 1855 Building Act did not specifically require a parapet to a wall adjacent to a street, and the alternative, then referred to as the "dripping eaves", was permissible. The danger of slates or tiles falling on the heads of passers by was seen as a very real one, and parapets were considered essential to prevent this (151). Dr. Liddle was a strong campaigner for this feature, although even he was prepared to concede that:

"if a parapet wall should be objected to, as interfering with the architectural design of the building, then provision should be made for properly securing the eaves gutter, and also for so constructing the sides of the gutter towards the public streets, that they might prevent the fall of anything from the roof that was likely to injure the public"(152).

The amending Bill of 1870 re-introduced the 12" high parapet, when adjacent to a street and in Liverpool the Act had provided that "nothing in this Act shall prevent any persons from carrying up any wall above the slates of the roof to form a parapet etc", but as 'The Builder' pointed out "not infrequently it has been found that when a parapet wall has been built over the cornice line, there has been nothing to prevent it coming down into the street at very short notice" (153).

The final element to consider here is the window. No rules for the size - or even for the provision of windows, existed in the 1855 Building Act. This aspect is discussed further in the following section. Constructionally however, the Act still perpetuated the long standing rule for the window frames to be set back 4" from the external face of wall. The usefulness of this rule was questioned by Horace

Gundry in 1870, who wanted to return to the flush frame, possibly as a result of the revival of interest in Queen Anne style. "It has been maintained in theoretical books", he wrote, "that glass should be as near as possible to the exterior to obtain the greatest light, It is scarcely conceivable that the existing rule is a security against fire" (154). This challenge brought forward a number of replies. Edward Power insisted that the object of the rule, as framed in accordance with Braidwood's suggestions, was to stop the burning window frame from falling outwards, rather than inwards (155). But J.F. Bentley disagreed:

"The clause in no way enforces us to rebate the jambs for the frames .. .. it does not compel us to keep the frame flush with the reveal. How can the mere setting back of  $4\frac{1}{2}$ " [the Act actually specified 4"] prevent the frame falling out? - and it allows the exposure of nearly any quantity of facial woodwork, provided it is in the required recess. Shortly after the Great Fire, when houses such as those in Cheyne Walk were built, window openings were treated as settings for glass, but in these days of anybody lecturing everybody on the principles of truths, they rarely rise above the level of holes in the wall. But are we not living in the age of burlesque?" (156).

In spite of this, the same regulation was repeated and incorporated in the Model By-laws of 1877.

\*\*\*

### Health

It has been noted earlier that the London by-laws of 1857 re-affirmed the widths for streets and courts originally contained in the 1844 Building Act, and that the Local Management Act of 1862 (157) re-established a controlling relationship between street widths and the height of building, similar again to the 1844 Act, but now operating in streets up to 50'0" wide, rather than 40'0" as before. (A similar clause had been included, as we shall see in the next chapter, in the Form of By-laws of 1858, but no dimensions had been inserted). In the face of increasing commercial pressure for higher buildings, the London standard of 1862 was re-considered when the amending Bill of 1870 was formulated. The Bill now proposed heights up to 60'0" in streets up to 40'0" in width, and 65'0" in streets over 40'0" wide. From the discussions which this proposal generated, two opposing interests emerged. On the one hand was Dr. Liddle and the medical men, insisting that "every new street have an adequate supply of sunlight, which is so

essential to health" (158). They wished to return to the direct and simple formula of the 1858 Form of By-laws and the 1844 Building Act which prevented the height of the building from exceeding the width of the street. On the other hand, the commercial world found spokesmen in Edward Barry and Sir Sydney Waterlow. Barry produced, at the Committee enquiry into the Bill of 1874, details and examples of ranges of building heights in both Paris and London - the former having buildings generally between 50 and 60 feet high, with two storeys in the roof. For himself, Barry favoured a height of 65'0", measured to the eaves, so that with a mansard roof it was still possible to have an extra storey in the roof. His Charing Cross Hotel, (although outside the Building Act as a railway building) was 70'0" to the eaves - but over 100'0" to the roof top (159). Sir Sydney Waterlow, whilst not wishing to deny the sanitary aspects, told the same Select Committee that 50'0" was not sufficiently high in streets even of 40'0" width, and that he saw no objection to even higher buildings in narrower streets. He already interpreted the existing Act to allow buildings to be over 50'0" high, provided they were set back to the extent to which they exceeded the 50'0", but he went on to suggest a maximum of 65'0" in streets 40'0" wide - with the possibility for the Board of Works allowing even greater heights "if they saw fit". With a final flourish, he looked to the future in support of his argument:

"It is impossible to tell what new plans or designs for buildings intelligent and talented architects might produce, and what circumstances might arise to justify their erection, with cubic content even larger than that contemplated by the Bill" (160).

The standard for court widths was still meagre, set as it was at a minimum 20'0". Even so, it only applied to new courts, and as Liddle told the Social Science Association in 1873, it was a major defect of the 1855 Building Act to still allow the rebuilding of old courts on their original foundations and to their original dimensions - often less than 20'0" (161). But no increase to the extent of this part of the law was introduced - it would no doubt have discouraged any rebuilding at all.

Projections beyond the line of buildings, particularly as more and more houses were being converted into shops, were not specifically prohibited (not withstanding the implied limitations of Section 143 of the Local Management Act) and could be determined by the Board of Works (162).

Yet the words 'projection', 'building', and 'regular line of building' were not defined in the Act and, as 'Tempora Mutantur' pointed out in 'The Builder' "consequently every individual may form his own - possibly very inaccurate - conclusions on the matter" (163). Certainly the determination of the line of fronts, or the regular line of building caused problems of interpretation. Broadwood's in Horseferry Road, for example, built a part of their factory 4'0" in advance of the line of the houses on either side. Should the line be set by the two or three houses on either side, or by a straight line drawn from the corners at Earl Street and Regent Place, or by a line on the other side of the roadway alongside the footpath? The magistrate determined that "section 147 does not necessarily mean a regular line of building from one end of the street to the other end - it speaks of a regular line of buildings in the street, and not of the street" - and the demolition of the offending part of the factory was therefore ordered (164).

Three bow windows, projecting a mere 13" at No 7, Beak Street, for the Scotch Stores, were called 'lamps' by the builder, Mr. Foxley. The architect, a Mr. Lavender, thought they came under Section 119 of the Local Management Act, relating to the annoyance or danger caused by projections into the street. The magistrate ruled that they fell within the Building Act, considering that no bay window "with a light in it" could properly be called a "lamp" and, though he had some regrets since they caused very little inconvenience, had to order their alteration (165). Shop front projections also caused confusion. Those on a shop at No 3, Bruton Street, projected a distance of 10", contrary to Section 26 of the 1855 Building Act. The magistrate concluded that this rule applied to projections over the public way, not over private property as in this case and as it was not beyond the line of shop fronts, dismissed the case. 'The Builder' commented "The worthy Magistrate is in great confusion, don't rely on his opinion. The decision may be right, but the reasons for it are wrong" (166). The clause made no distinction at all between projections over private or public property.

The 1855 Building Act did not specify the level at which the already minimal area of 100 sq.ft. of open space was to be situated at the rear of a house and it was soon discovered that there was nothing to prevent the filling in or building over the yard, by shops for example. A piano shop in Charles Street in 1858 was the test case: the magistrate

allowed the rear extension to remain (167). This decision was welcomed by a gentleman signing himself 'Vigilans' : "It is a hardship where a shop is small and is sought to be enlarged to urge objections to enlarging it, as ventilation, if not light, is often improved by such enlargement" (168). Once again business and commercial interests, this time in the form of pressure from the shopkeeper, had a prior claim over the more rarified and subjective theories of health. As the District Surveyor who had been involved in the case said:

"The want of through ventilation through the basement storey is, no doubt, a great evil, but the impediment to trade which an area of 100 sq. ft. left open on the ground storey would occasion, must make every architect thankful that the clause does not necessarily bear a construction which materially differs from that of the 1844 Act and that the District Surveyor cannot be called to account for allowing the whole ground storey to be covered with the building" (169).

It was not only in the case of shops, but also other property owners who managed to succeed in building within the stipulated 100 sq. ft. of yard area. Mr. Burk built two w.c.'s, one above the other, connected to the house but encroaching on his yard at the rear of his house in Gipsy Hill, Norwood, in 1862. To overcome any objection, the ingenious Burk inserted a window between the front and back room on the ground floor, and thereby claimed to have lit both rooms from the street - in accordance with the Act. The magistrate reluctantly had to accept that this device was legal (170). It is not surprising to see so many evasions of this regulation, since, as Liddle pointed out in 1861 (171), the regulation did not say that the yard space had to extend the full width of the house with a certain extent immediately at the rear, nor that it could be 2'0" wide or even less, provided it was of such a length to give the required area of 100 sq. ft.; nor that its function was for the purpose of lighting and ventilation.

Outside London, the provision for the backyard was generally of a higher standard. This will be discussed further in the following chapter. But even in Hull, under its Improvement Act of 1854 (172) - a year before the London Act - the space for the yard was to be 8'0" deep, but running the full width of the house. Even with the smallest houses, this would often have produced a yard larger than the London standard, and it would have been of a reasonable proportion. This Hull Act also called for a space 20'0" wide in front of the house (173) - and as late as 1870, Liddle was still asking for a similar requirement in London, for all houses, (174).

London attempted to meet the higher standards of the 1858 Form of By-laws, and those of many provincial towns, when, in its amending Bill of 1874, it called for an area of 150 sq.ft. for the backyard. Even then, the Bill was badly worded, as Godwin discovered and pointed out to an embarrassed Board of Works, since it would have allowed tall back-to-back buildings to be built (175). The following year, the year of the Public Health Act, George Ross was still seeking 150 sq.ft. (not less than 10'0" in width) for the area of the backyard, belonging exclusively to each house (176). But, by the time of the Model By-laws of 1877, London was still held to the lower standard of the 1855 Building Act.

Drainage was still controlled only very ineffectually. Plans for the drainage of houses did not have to be submitted, nor the drains inspected before they were covered in. In 1866 the Medical Officers of Health had urged the Home Secretary and the Board of Works, to rectify both these matters by means of legislation (177). Houses were built and occupied before the sewers were built, no proper ventilation was required for drains, and traps were largely experimental and prone to failure. "The evil that results from the insufficient trapping of drains is immense and widespread" wrote Godwin in 1862 (178). Dr. Liddle constantly sought proper controls for these drainage matters, including the approval of plans and the requirement of a separate w.c. for each house (179), but his efforts were, as so often, ineffectual at the time, but helped to consolidate and direct a line of reform which was to gain acceptance at a later date. Collins repeated these suggestions in 1873, adding that vent pipes to soil stacks should be taken above the roof, that rainwater pipes should not be used as waste pipes, and that sink wastes should discharge over an open area for easy cleaning (180) - all matters to come through in the Model By-laws of 1877, but all still outside control in London. George Ross, whose pronouncements were sometimes rather extreme for his time, proposed that the w.c. should always be detached from the house, or so situated that there should be a space for a current of air between the house and the closet (181) - a forecast of the ventilated lobby to lavatory accommodation.

Following the illness of the Prince of Wales from typhoid in 1871 - a crisis of national proportions - 'The Times' appealed for attention to

be given to the matter of ventilation:

"Every profession is now on its trial, and none can claim immunity from the universal law of progressive reform. Several professions have to do with this matter - architects, builders, engineers, medical men and the whole sanitary school. Our houses profess to secure us from the dangerous play of the elements. But this includes something more than wind, rain, heat, cold, fire and water. It should include the element which is the first condition of life - the air we breathe" (182).

'The Times' went on to suggest ventilation shafts "carrying the effluvia high over our heads, above the level of gutters, cisterns and soft water supply" (183) - the obnoxious odours would, it was feared, percolate the water supply - and in the following month it enthusiastically supported a suggestion from a Dr. Carpenter for a vent pipe to be located on the sewer side of a trap at the bottom of the soil pipe (184). In practice this became the vent at the point before all the house drainage just entered the main public sewers.

From external ventilation to internal ventilation: the problem of getting rid of the 'vitiating air' was still an obsessive concern for many people. The 1855 Building Act made no reference to it at all - not even to a window in each room. As Liddle said in 1861:

"the advantages to the health of man in making provision for the free admission of light and air into their dwellings are now so well understood .... but it is incumbent upon us, as Medical Officers of Health, to impress upon the Government the necessity of enacting that landlords shall not erect houses for habitation which are not provided with the requirements necessary for preserving the health of the occupants" (185).

More practically, Godwin had surveyed the relative merits of patent air bricks and the patent systems for "admitting fresh air involuntary, and without draught, in every room, and to take away foul air" in a discussion at the Institute of British Architects in 1862 (186). The medical men persevered in their campaign, urging the Home Secretary in 1866 to demand that the means of ventilation be shown on drawings (187), and urging the Board of Works to amend their Bill in 1867 to show the size, position and construction of window and ventilated openings (188). Support even came from the legal world. The Editor of 'Justice of the Peace' wrote in 1865:

"It may be impossible to insist upon a man keeping the window of his room open from time to time, if he prefers the hot and noxious atmosphere of a closely shut up room, it would be difficult to give authority to an officer of health to enter the premises and insist upon the windows and doors being kept open for a certain portion of the day, but much may be done by carefully looking at the construction of



houses. The Building Acts contain some valuable provision, but it is believed they need some considerable extension, and the introduction of clauses to prevent the evasion of their enactments" (189).

Dr. Liddle, in 1873, continued to call for stairs, passages and the underside of the ground floor to be properly ventilated (190). Godwin a year later repeated this, calling for a 6" air space under a timber floor, with air bricks, whether or not the ground itself was covered with concrete (191); and George Ross, in 1875, for the ventilation of stairs, rooms to be a minimum of 150 sq.ft.in area. with a fireplace and a window at least 16 sq.ft.in area (192). In the year that Liddle had suggested that an amending bill should control windows (1867), it is relevant to note that Manchester had produced a by-law covering just such a requirement. There a window was required in every dwelling or sleeping room, the total area of the window clear of the sash frame to be 10 sq.ft, the top to be not less than 7'6" above the floor level, with the upper half openable. A similar rule applied to the attic, though the top of the window there was only to be 6'6" above the floor level : alternatively it could have a skylight at least 6 sq.ft.in area, one third of which was openable. Liddle, it may be noted, considered skylights to be objectionable in inhabited rooms (193). Rather outside our field, but a matter which continually raised its head, was the problem of 'ancient lights'. Traditionally a Common Law matter, it remained outside the written, statute law, but the vagaries of its operation often led to suggestions for its reform: H.and.R.Powell for example, suggested in 1870 that a new Building Act should be extended to cover this difficult and rather obscure matter (194).

The rule governing the minimum room height at 7'0" was constantly evaded. Mr. Holding built nine houses in Inkerman Road, Kentish Town, with rooms 6'6" max and 2'10" min in height. A tenant was produced before the Magistrates' Court who actually slept in one of them, but Mr. Holding claimed that they were only storerooms, 'on account of their small area and height'. He contended that it was impossible that he could ever have intended them to be inhabited. The magistrate agreed - but it was a decision entirely contrary to the spirit of the Act (195).

Liddle suggested 8'0" as a minimum room height in 1861 (196), which the Medical Officers repeated in their deputation to the Board of Works

in 1867 (197). Manchester's by-laws of the same year had 9'0" as a minimum, with 7'6" over one third of the floor area in the roof, considerably higher than London, and also higher than the 1858 Form of By-laws which set 8'0" as the minimum. Collins, in 1873, reaffirmed support for the 8'0" provision (198), as did Godwin to Select Committee enquiry in 1874 (199), though Sir Sydney Waterlow, to the same committee, said that 8'6" was the minimum in his model dwellings: "we have thought that ought to be a minimum, because if we had thought a less height would be sufficient to admit of proper sanitary arrangements, we should not have gone to that height, because economy is a most important matter with us" (200)

- and that was 1'6" higher than the current London minimum. George Ross, again at an extreme, preferred 9'0" minimum for habitable rooms (201). At the time of the Public Health Act of 1875 therefore, the range was from 7'0" in London to 9'0" in Manchester, with a general preference amongst most experts for 8'0" - the same incidentally as the Form of By-laws of 1858. But there was a stumbling block ahead. Although, as a 'Surveyor to a Sanitary Authority' wrote in September 1875 "nearly all local authorities have had a by-law regulating the height of rooms intended for habitation" (202), it was considered by the lawyers that the Public Health Act of 1875 did not permit by-laws <sup>to be</sup> made for this matter of room heights. The Editor of 'The Builder' noted: "The fact that by-laws for regulating the height of rooms are 'ultra vires', as they are not within the application of the Statute which authorizes by-laws as to ventilation is, we believe, correct". (203). The matter of room heights was not to appear in the by-laws again until much later in the century (see page 444).

\*\*\*

In this chapter we have recorded little in the way of new legislation in London, other than the contents of the Building Act of 1855 itself, but we have nevertheless encountered a good deal of debate and discussion behind the scenes. This is because the tempo of change in building was beginning to increase and whilst it may be said that the 1855 Building Act marked only a small advance over that of 1844, its failure by 1875 to have kept pace with the changing scene cannot be denied and even at the time it was the source of some embarrassment. Furthermore, looking outside at the trends in the Provinces (and which we discuss in the next chapter), it was becoming clear that the Public

Health movement and its realisation in building regulation terms in the Model By-laws of 1877 were going to widen the gap still further.

Three aspects do however stand out in this chapter, and even though they have been present in an embryonic form in the earlier chapters, they can be drawn together at this point. They concern the growing and very vocal pressures coming from what might be called the 'vested interests', whose common 'raison d'etre' was finance. They concern the growing expertise, involvement and respect coming from the professions, and they concern an emerging trend towards a more scientific and rational understanding of the nature of building performance and its control in the context of fire, stability and health.

There were a great many groups with so-called 'vested interests', but their perpetual complaints and demands seem to have had more influence on the legislature than did perhaps any other sector of society connected with building. This is not altogether surprising, since their concern is with business and trade, investment and profit, employment and economic prosperity - a ruthless religion which no Victorian would readily condemn or restrain, least of all by what would seem to be trivial building regulations. Then there is a growing middle class involvement, as the class most concerned with trade, and a consequent political power which was not to be underestimated. So the piano manufacturers protest, the timber merchants protest, the marine boiler makers protest, the builders of model dwellings for the working classes protest - but above all it is the shopkeepers who protest the loudest, and all their complaints are seriously heard and in many cases are acted upon. Behind the scenes there are also the insurance companies, whose conservative attitude can limit building experiment, and to whom building controls, particularly in warehouses, can never, it seems, be strict enough.

The growth in the size and influence of the professions was slow but effective. The longer established medical profession naturally seems to have held more respect than any other, and a number of the suggestions coming from that quarter were very sensible. It is interesting for example, bearing in mind the comments made at the end of chapter I, regarding the grafting of the health clauses onto the older constructional regulations, to find one doctor suggesting that they be divided

again - but with a conservative legal profession and the architects fearing a resultant disintegration and a multiplication of the controls, it is not taken any further and the opportunity is lost. Of more significance was the medical profession's interests in the question of sunlight, now in addition to ventilation, and the benefits which would result from trying to secure its admission into the increasingly dense fabric of the built-up areas in the towns. But there it comes into direct conflict with commercial pressures, to whom higher buildings and a full use of the land represents a healthy financial return, more important than the healthy condition of the inhabitants.

The architects maintained a more conservative position and preferred to continue to operate under the old and well tried act rather than risk a new set of controls. There is also a hint that they had some sympathy with the 'vested interests' mentioned earlier - the interests of their clients and the retention of their business could sometimes assume more significance than was perhaps proper for their position and professional status.

Finally there was now emerging a new spirit of enquiry, a search for more rational explanation, as a more scientific approach to building matters developed. Long-standing concepts were re-appraised. Stone was perhaps not so effective in a fire as had been previously assumed. The inter-relationship of the various elements in a building were, as we have seen in the case of cross walls, beginning to be appreciated. This was taken further, for example, with the acceptance of the fact that allowance could be made for the effect of bracing to a wall provided by floor joists. Again the idea that walls and foundations should be designed according to their function in carrying loads was suggested, as was the possibility that some acknowledgement should be made of the loss of heat through walls. At the same time, new building types were emerging. There were developments in buildings outside the control of the building regulations, such as those connected with railways for example, which could achieve new technical advances and their success could not be ignored for ever. New materials and services were introduced. Some, like concrete, were to be held back by the legislation; others, such as gas lighting, produced problems not anticipated by the legislation. Altogether there was a more complicated

fabric of building, whose advance served only to highlight more and more the irrelevance and hinderance which much of the building act perpetuated. On the other hand, the process of building, the actual method of construction, remained largely unaltered. The bulk of building, for which the regulations also had to apply, remained, dominated by the traditions of the speculative builder.

We must now leave London at this the nadir of its history of building regulation, and turn to follow the developments which were taking place in the provinces at the same time. The London story and the account of its eventual ascendancy to its summit in 1894 is resumed in chapter VII.

\*\*\*\*\*

NOTES TO CHAPTER IV

- 1 For example : H.A.Darbishire, "On the Construction of Dwellings for the Poor", delivered to the Architectural Association in 1863:-  
"The most economical site dimensions, in the Metropolitan Board of Works jurisdiction are 108'0" x 60'0". It accommodates a building 108'0" x 34'0", leaving a playground 26'0" deep at the rear. 108'0" x 34'0" is 3,600 sq.ft. in round figures, it is the area allowed by the arbitrary Act by which we are governed to a building containing several distinct tenements, and possessing only one entrance and stair". He went on to suggest a height of 46'0" from the ground to the eaves 'it admits as many storeys of dwellings as can be occupied with comfort, and requires no unnecessary thickness of walls'. This would result in a 5 storey building, 40-45 dwellings, 16 latrines, 8 laundries and 8 baths and coppers'.  
B.Vol.21 No.1085 21 Nov. 1863 p.821.
- 2 R.Williams, "The Building Act of London, thoughts and Suggestions",  
B.Vol.70 No.2770. 7 Mar. 1896 p.210.
- 3 E.g. The Euston Road Act of 1821, which set a building line at 50'0" from the roadway.
- 4 B.Vol.14 No.712 27 Sept. 1856 p.529.
- 5 B.Vol.15 No.774 5 Dec. 1857 p.713.
- 6 B.Vol.14 No.677 26 Jan. 1856. By-laws published 1 May 1857.
- 7 19 & 20 Vic.cap.112 29 July 1856.
- 8 25 & 26 Vic.cap.102 7 Aug 1862.
- 9 23 & 24 Vic.cap.52 23 July 1860.
- 10 B.Vol.18 No.918 8 Sept. 1860 p.573.
- 11 25 & 25 Vic.cap.87.
- 12 17 & 18 Vic.cap.107.
- 13 32 & 33 Vic.cap.82.
- 14 B.Vol.27 No.1384 14 Aug. 1869 p.651.
- 15 B.Vol.29 No.1483 8 July 1871 p.524.
- 16 B.Vol.16 No.796 8 May 1858 p.314.
- 17 B.Vol.19 No.960 29 June 1861 p.439 and The Times 29 June 1861 p.9 col.b.
- 18 B.Vol.19 No.963 20 July 1861 p.496.
- 19 B.Vol.20 No.1018 9 Aug 1862 p.574.
- 20 B.Vol.22 No.1108 30 Apr. 1864 p.321
- 21 B.Vol.22 No.1139 3 Dec. 1864 p.888.
- 22 B.Vol.23 No.1157 8 Apr. 1865 p.248
- 23 28 & 29 Vic.cap.90.
- 24 B.Vol.23 No.1174 5 Aug. 1865 p.561.
- 25 B.Vol.25 No.1253 9 Feb. 1867 p.95 and B.Vol.25 No.1266 11 May 1867 p.338.
- 26 B.Vol.25 No.1278 3 Aug. 1867 p.579.
- 27 B.Vol.26 No.1321 30 May 1868 p.399.
- 28 B.Vol.26 No.1351 26 Dec. 1868 p.951.
- 29 B.Vol.28 No.1417 2 Apr. 1870 p.273.
- 30 B.Vol.28 No.1420 23 Apr. 1870 p.330.
- 31 B.Vol.28 No.1421 30 Apr. 1870 p.350.
- 32 B.Vol.28 No.1422 7 May 1870 p.371.
- 33 B.Vol.28 No.1423 14 May 1870 p.383.
- 34 B.Vol.28 No.1426 4 June 1870 p.422.
- 35 B.Vol.30 No. 1515 17 Feb. 1872 p.124.
- 36 B.Vol.29 No.1506 16 Dec. 1871 p.982.

- 37 B.Vol.31 No.1605 8 Nov. 1873 p.880.  
38 B.Vol.31 No.1606 15 Nov. 1873 p.909.  
39 B.Vol.32 No.1625 28 Mar. 1874 p. 278  
40 B.Vol.32 No.1627 11 Apr. 1874 p.300.  
41 The Times 30 Apr. 1874 p.9 col.c.  
42 Ibid.  
43 Ibid.  
44 B.Vol.32 No.1630 2 May 1874 p.367.  
45 B.Vol.32 No.1633 23 May 1874 p.430.  
46 B.Vol.32 No.1635 6 June 1874 p.473.  
47 B.Vol.32 No.1636 13 June 1874 p.493.  
48 Ibid.  
49 B.Vol.32 No.1638 27 June 1874 p.549-51.  
50 B.Vol.32 No.1639 4 July 1874 p.557.  
51 B.Vol.32 No.1658 14 Nov. 1874 p.939.  
52 B.Vol.19 No.986 28 Dec. 1861 p.892.  
53 B.Vol.23 No.1145 14 Jan. 1865 p.31.  
54 B.Vol.24 No.1196 6 Jan.1866 p.17.  
55 B.Vol.24 No.1246 22 Dec. 1866 p.940.  
56 B.Vol.25 No.1253 9 Feb. 1867 p.95.  
57 B.Vol.25 No.1266 11 May 1867 p.338.  
58 Letter. Appendix to the Royal Sanitary Commission Report of 1871.  
59 B.Vol.29 No.1506 16 Dec. 1871 p.982.  
60 B.Vol.31 No.1564 25 Jan. 1873 p.63.  
61 Ibid.  
62 B.Vol.31 No.1565 1 Feb.1873 p.88-9.  
63 B.Vol.32 No.1629 25 Apr. 1874 p.348.  
64 B.Vol.17 No.851 28 May 1859 p.364  
65 B.Vol.20 No.994 22 Feb.1862 p.125.  
66 B.Vol.21 No.1041 17 Jan. 1863 p.37.  
67 B.Vol.22 No.1093 16 Jan. 1864 p.41.  
68 B.Vol.27 No.1396 6 Nov. 1869 p.882.  
\*69 H.H.Collins, "Suggestions relating to some defects in the Metropolitan Building Act (18 & 19 Vic.cap. 122) as applied to dwelling houses", to the Health section of the National Association for the promotion of Social Sciences. Norwich, October, 1873.  
70 B.Vol.32. No.1629 25 Apr. 1874 p.347.  
71 B.Vol.32 No.1630 2 May 1874 p.367.  
72 B.Vol.32 No.1633 23 May 1874 p.430.  
73 B.Vol.32 No.1658 14 Nov.1874 p.939.  
74 B.Vol.14 No.684 15 Mar. 1856 p.137-9.  
75 B.Vol.14 No.716 25 Oct. 1856 p.581.  
76 B.Vol.26 No.1344 7 Nov. 1868 p.827.  
77 B.Vol.19 No.986 28 Dec. 1861 p.893.  
78 The Times, 1 Jan. 1859 p.6 col.e.  
79 B.Vol.23 No.1145 14 Jan. 1865 p.31.  
80 B.Vol.23 No.1157 8 Apr.1865 p.248.  
81 B.Vol.28 No.1405 8 Jan. 1870 p.33.  
82 B.Vol.28 No.1407 22 Jan. 1870 p.71.  
83 B.Vol.19 No. 960 29 June 1861 p.439.  
84 B.Vol.19 No.962 13 July 1861 p.486.  
85 Ibid.  
86 B.Vol.24 No.1216 26 May 1866 p.378.  
87 B.Vol.19 No.960 29 June 1861 p.439.  
88 6 & 7 Vic.cap.109.  
89 B.Vol.14 No.692 10 May 1856 p.258.  
90 The Times, 5 August 1861 p.6 col.d.  
(\*69) B.Vol.31 No.1601 11 Oct. 1873 p.800.

- 91 The Times, 11 Feb. 1862 p.9 col.a.  
 92 28 & 29 Vic.cap.90.  
 93 B.Vol.22 No.1133 22 Oct. 1864 p.780.  
 94 B.Vol.27 No.1374 5 June 1869 p.452.  
 95 B.Vol.17 No.868 24 Sept. 1859 p.631.  
 96 B.Vol.20 No.1021 30 Aug. 1862 p.624.  
 97 B.Vol.23 No.1156 1 Apr. 1865 p.229.  
 98 The Times, 16 Aug. 1867 p.7 col.b.  
 99 B.Vol.29 No.1478 3 June 1871 and B.Vol.29 No 1508 30 Dec. 1871 p.1022.

Also listed were brickwork in good mortar, slate, tile, terra-cotta, granite or other hard stone, and concrete for filling between joists.

- 100 B.Vol.14 No.682 1 Mar. 1856 p.121.  
 101 B.Vol.14 No.696 7 June 1856 p.308.  
 102 B.Vol.24 No.1247 29 Dec. 1866 p.961.  
 103 Ibid.  
 104 B.Vol.27 No.1358 13 Feb. 1869 p.131.  
 105 B.Vol.29 No.1504 2 Dec. 1871 p.952.  
 106 B.Vol.33 No.1675 13 Mar. 1875 p.240.  
 107 B.Vol.20 No.985 1 Mar. 1862 p.158.  
 108 38 and 39 Vic.cap.70.  
 109 B.Vol.33 No.1705 9 Oct. 1875 p.913.  
 110 B.Vol.21 No.1072 22 Aug. 1863 p.608.  
 111 B.Vol.32 No.1637 20 June 1874 p.519.  
 112 B.Vol.20 No.1038 27 Dec. 1862 p.935.  
 113 The Times, 26 Oct. 1871 p.9 col.d.  
 114 B.Vol.15 No.737 21 Mar. 1857 p.166.  
 115 B.Vol.18 No.917 1 Oct. 1860 p.566.  
 116 B.Vol.23 No.1169 1 July 1865 p.472.  
 117 B.Vol.28 No.1445 15 Oct. 1870 p.830.  
 118 B.Vol.20 No.994 22 Feb. 1862 p.125.  
 119 Ibid.  
 120 Godwin had received the Silver medal from the Institute of British Architects for his essay "The Nature and Properties of Concrete" some thirty years earlier. Institute of British Architects Transactions, Vol.1. Pt. 1, 1835-36.  
 121 see R.H.Harper, "Concrete's battle for London, 1867-1886" CONCRETE Vol.10 No.10, October 1976 p.28.  
 122 e.g. T.Wonnacott, "The uses of Portland Cement" (given at R.I.B.A. in 1871), A.Payne, "Concrete as a building Material", (given at R.I.B.A. in 1876), A.Coates, "Concrete and fire-resisting construction" (R.I.B.A. General Conference in 1878).  
 123 B.Vol.31 No.1565 1 Feb. 1873 p.88.  
 124 Ibid, p.89.  
 125 B.Vol.31 No.1601 11 Oct. 1973 p.800-1.  
 126 B.Vol.15 No.727 10 Jan. 1857 p.30.  
 127 B.Vol.19 No.986 28 Dec. 1861 p.893.  
 128 B.Vol.20 No.994 22 Feb. 1862 p.125.  
 129 Royal Sanitary Commission, First Report, 1869 p.xxix.  
 130 Ibid. Second Report, 1871 p.113.  
 131 B.Vol.28 No.1423 14 May 1870 p.383.  
 132 B.Vol.31 No.1610 11 Oct. 1873 p.800-1.  
 133 B.Vol.32 No.1637 20 June 1874 p.519.  
 134 B.Vol.33 No.1700 4 Sept. 1875 p.802.  
 135 B.Vol.33 No.1686 29 May 1875 p.490.  
 136 B.Vol.16 No.787 6 Mar. 1858 p.164.  
 137 Ibid.



- 138 B.Vol.31 No.1601 11 Oct. 1873 p.800-1.  
139 B.Vol.33 No.1685 22 May 1875 p.458.  
140 B.Vol.14 No.675 17 Jan. 1856 p.13.  
141 B.Vol.14 No.724 20 Dec. 1856 p.691.  
142 B.Vol.15 No.726 3 Jan. 1857 p.8.  
143 Ibid.  
144 B.Vol.32 No.1636 13 June 1874 p.494.  
145 B.Vol.16 No.798 22 May 1858 p.359.  
146 B.Vol.20 No.993 15 Feb. 1862 p.120.  
147 B.Vol.26 No.1352 2 Jan. 1868 p.15.  
148 B.Vol.28 No.1428 18 June 1870 p.477.  
149 Ibid.  
150 Report of the Special Sub-committee of the Liverpool Architectural and Archaeological Society on the proposed amendments to the Building Act. November 1869.  
151 B.Vol.17 No.876 19 Nov. 1859 p.767.  
152 B.Vol.19 No.986 28 Dec. 1861 p.893.  
153 B.Vol.28 No.1428 18 June 1870 p.478.  
154 B.Vol.28 No.1422 7 May 1870 p.371.  
155 B.Vol.28 No.1424 25 May 1870 p.410.  
156 B.Vol.28 No.1426 4 June 1870 p.453.  
157 25 & 26 Vic.cap.102 sec.85.  
158 B.Vol.31 No.1565 25 Jan. 1873 p.63.  
159 B.Vol.32 No.1636 13 June 1874 p.493.  
160 B.Vol.32 No.1637 20 June 1874 p.519.  
161 B.Vol.31 No.1565 25 Jan. 1873 p.63.  
162 B.Vol.14 No.686 29 Mar. 1856 p.180.  
163 B.Vol.14 No.688 12 Apr. 1856 p.206.  
164 B.Vol.15 No.743 2 May 1857 p.251.  
165 B.Vol.19 No.943 2 Mar. 1861 p.149.  
166 B.Vol.24 No.1204 3 Mar. 1866 p.162.  
167 B.Vol.16 No.824 20 Nov. 1858 p.784.  
168 Ibid. p.786  
169 B.Vol.16 No.825 27 Nov. 1858 p.805.  
170 B.Vol.21 No.1042 24 Jan. 1863 p.69.  
171 B.Vol.19 No.986 28 Dec. 1861 p.892-3.  
172 17 & 18 Vic.cap.101 sec.99. (also case of Pearson v. Hull, 29J.P.695 and 30J.P.51).  
173 Ibid. sec.97.  
174 B.Vol.29 No.1506 16 Dec. 1871 p.982.  
175 B.Vol.32 No.1637 20 June 1874 p.519.  
176 B.Vol.33 No.1700 4 Sept. 1875 p.802.  
177 B.Vol.24 No.1196 6 Jan. 1866 p.17 and B.Vol.25 No.1253 9 Feb. 1867 p.95.  
178 B.Vol.20 No.994 22 Feb. 1862 p.126.  
179 B.Vol.31 No.1565 25 Jan. 1873 p.63.  
180 B.Vol.31 No.1601 11 Oct. 1873 p.800-1.  
181 B.Vol.33 No.1700 4 Sept. 1875 p.802.  
182 The Times, 7 Dec. 1871 p.9 col.c.  
183 Ibid.  
184 The Times, 16 Dec. 1871 p.9 col.a. and 15 Jan. 1872 p.9. col.d.  
185 B.Vol.19 No.986 28 Dec.1861 p.892.  
186 B.Vol.20 No.994 22 Feb. 1862 p.125-8.  
187 B.Vol.24 No.1196 6 Jan. 1866 p.17.  
188 B.Vol.25 No.1253 9 Feb. 1867 p.95.  
189 "Justice of the Peace", Vol.XXIX, No.44, 4 Nov. 1865, p.689.  
190 B.Vol.31 No.1565 25 Jan. 1873 p.63.

- 191 B.Vol.32 No.1637 20 June 1874 p.519.  
192 B.Vol.33 No.1700 4 Sept. 1875 p.802.  
193 Royal Sanitary Commission, Second Report, 1871, Paragraph, 12,274.  
194 B.Vol.28 No.1426 4 June 1870 p.453.  
195 B.Vol.17 No.830 1 Jan. 1859 p.16.  
196 B.Vol.19 No.986 28 Dec. 1861 p.893.  
197 B.Vol.25 No.1253 9 Feb. 1867 p.95.  
198 B.Vol.31 No.1601 11 Oct. 1873 p.800-1.  
199 B.Vol.32 No.1637 20 June 1874 p.519.  
200 B.Vol.32 No.1638 27 June 1874 p.549.  
201 B.Vol.33 No.1700 4 Sept. 1875 p.802.  
202 Ibid. p.804.  
203 Ibid. p.804.
-

18 and 19 Vic.cap.120

DATE: 14 August 1855

Reference in text : page 163

	SELECTED CLAUSES relating to building design and construction Summary of contents	LINKS	
		ANTE	POST
101	HABITABLE CELLARS No vaults or cellars under streets without Vestry consent.		T14.c101
103	Definition : Rooms with floors more than 3'0" below street level, 1'0" of cellar height to be above street level. Area = 3'0" wide, (5'0" x 2'6" outside the window). Window = 9 sq.ft., of which 4½ sq.ft. to open. Fireplace and flue required. Effective drainage, use of w.c. privy and ashpit required. Floor to ceiling height = 7'0" min. Steps down to area allowed, but not over or across the window.	T4.ScK  as above also in Public Health Act 1848 and T5.c119	T13.c96
105	STREETS Paving of streets.  No dimensions in act but by-laws published 1 May 1857 set carriageways = 40'0" and non-carriageways = 20'0" (alleys and courts). Amendment to Local Management Act of 7 August 1862 set limits to height of buildings (except churches and chapels) in new streets less than 50'0" wide: height to equal width of street. (sect 85) (Min. widths of 40'0" and 20'0" set again in section 98).		T14. c105
		T4 ScI	T11 c4
143	Building line : operative within and up to 30' from highway.	Local Acts	Local Gov. Act 1858 sec 35
141	Streets to be named and houses to be numbered.	T5. c63	
202	Powers to make by-laws for streets and plans required for level of sites for buildings and notices of materials for drains, etc.		T14. c202
71	DRAINAGE Gullies etc. to be trapped.	T4.ScH	T7.c21

72	Sewers to be cleansed.		T14.c71 to 77 inc.
73	Owners may be compelled to provide drains.		
74	Provision for combined drainage to blocks of houses.		
75	No house to be built without drains, to satisfaction of vestry or district board.	Public Health Act 1848	T7. c26 and T7. c19 and Metropolis Local Management Acts Amendment Act 1862
77	Powers to branch drains into sewers of Met. Board.		

	SELECTED CLAUSES relating to building design and construction Summary of contents	LINKS	
		ANTE	POST
	<b>STRUCTURE</b>		
Sch.I cl.1	Foundations, on solid ground, or on concrete or other solid substructure.	T4.ScD	T7.c6
Sch.I cl.8	Footings - see Table 6, sheet 9.		T8.c15
	<b>WALLS</b>		
Sch.I cl.1&2	Thickness - see Table 6, sheet 8, note that external and party walls are now identical.	new	T8.S8-9
Sch.I cl.1&2	Walls to be of brick, stone or other hard and incombustible substance, properly bonded with mortar and cement. No part of wall to overhang any part underneath.	T4.Sc.D	T7.c7
		new	T8.c13
Sch.I part II	Stone walls, where not laid in horizontal beds to be $\frac{1}{3}$ greater width than wall thickness table.	Bristol	T8.c22
Sch.I partII	Cross walls : $\frac{2}{3}$ thickness of external or party walls, $8\frac{1}{2}$ " min, not less than $\frac{2}{3}$ height of external or party wall. Recesses and openings not more than $\frac{1}{2}$ vertical surface area of wall in each storey.	New (see also T4.s10	T8.c21
		new	T8.c23
cl.13	Recesses in external walls if backs $8\frac{1}{2}$ " min. Area of recesses and openings together not to exceed $\frac{1}{2}$ area of wall in which they are made. In party walls, recesses allowed if backs not less than 13" thick. Area rule as for external wall, and no recess to be within 1'0" of inside of external wall.	T4. ScD	T8.c29
		new	
cl.14	Timber in external wall: loophole frames allowed up to $1\frac{1}{2}$ " of external face, otherwise all wood (except bressummers, storey posts under and shop frames) to be set back 4" min.	T4.ScD	T8.c24 and T7.c9
Sch.I part I cl.4, 5 & 6	For modifications to wall thickness rules and in respect of storey heights - see wall thickness schedule Table 6 sheet 9,10.	new	T8.S8-9
	<b>PARAPETS</b>		
cl.16	Where gutter is of combustible material then parapet to be 12" high above gutter and to be $8\frac{1}{2}$ " thickness minimum.	T4.ScD	T8.c25

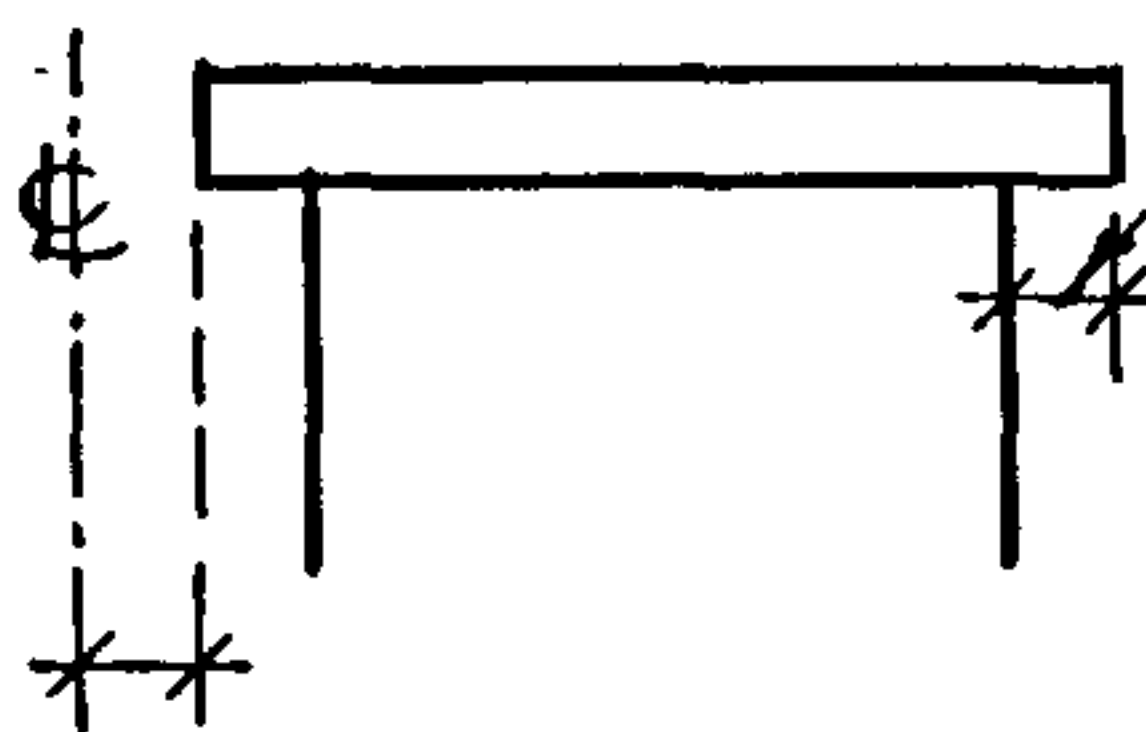
<p>cl.15</p>	<p>Bressummers :</p>  <p>4" min. bearing on brick stone, iron, timber storey post in addition to further bearing on party wall.</p> <p>4½" from end of bressummer to centre line of party wall.</p> <p>No bond timber or wood plate to be built into party wall. No beam or joist to be less than 4½" from centre line of party wall. All bressummers to be carried on stone or iron corbels, tailed through at least ½ thickness of party wall, of full width of bressummer.</p>	<p>T4.ScD</p>	<p>T8.c34</p> <p>T8.c31</p>
<p>cl.17</p>	<p><b>PARTY WALLS ABOVE ROOF</b></p> <p>To project 15", measured at right angles to slope of roof.</p> <p>If turret, dormer, lanternlight is within 4'0" of party wall, then wall to be carried up 12" higher and wider than such erection.</p>	<p>T4.ScD and T5.c109</p>	<p>T7.c8 and T8.c26</p>
<p>cl.18</p>	<p><b>CHASES IN PARTY WALLS</b></p> <p>14" max width 4½" max depth from face of wall, so as not to leave less than 8½" at back or side. No chase to be nearer than 7'0" from another chase in same side of wall.</p>		<p>T8.c26</p> <p>T8.c30</p>
<p>cl.19</p>	<p><b>ROOFS</b></p> <p>Materials: slate, tile, metal or other incombustible materials, except for necessary door and window frames, etc.</p> <p>Warehouse roofs: max. pitch 47° from horizontal Roof drainage: see Projections, clause 26.</p>	<p>T4.ScG and T5.c109</p>	<p>T7.c10 and T8.c52</p> <p>T14.c61</p>
<p>cl.24</p>	<p><b>PARTY ARCHES</b></p> <p>If arch of brick or stone then to be: 4½" thick in span up to 9'0" and 8½" thick in span over 9'0". If iron used, then to be to District Surveyor approval.</p>	<p>T4.ScD</p>	<p>T14.c71</p>
<p>cl.25</p>	<p><b>ARCHES UNDER PUBLIC WAY</b></p> <p>If arch of brick or stone then to be: 8½" thick in span up to 10'0" and 13" thick in span up to 15'0". If iron is used or arch is over 15'0" span, then to D.S. approval</p>		<p>T14.c72</p>

cl.20	<p><b>CHIMNEYS</b>  Corbelling now allowed, above ground floor ceiling level, if projection not more than same as wall thickness. All other chimneys to be on footings and foundations as per walls.  Flues can be at any angle if with proper access doors 6" sq.min., otherwise max. angle of flue to be 130°.  Arch over chimney openings: if breast projects more than 4½" from wall, and jambs less than 17½" wide, then iron bar required, built 8½" min into each side.  Rendering, pargetting or fireproof lining inside and outside of all flues, except on outer face of external wall.  Jambs: 8½" min width.  Breast, front, withe, partition and back of flue to be 4" thick min.  Thickness of back of opening to be 8½" from level of hearth to height of 12" above mantel, if a party wall. 4½" if not a party wall.  Thickness of upper side of flue, when angle less than 45° to be 8½" min.  Chimney shaft: 3'0" above highest part of roof 4" brick or stone on all sides. Height of chimney shaft Max=6 times the width unless bonded to another shaft or otherwise secured.  Hearth of slate or stone, 12" longer than opening and 18" min width in front of chimney on stone or brick trimmers.  Thickness of hearth = 7" min.  No flue against a party wall unless a withe is properly secured to it, 4" thick  No cutting into chimney shaft, jamb, breast, flue etc without D.S.permission, except for alteration to soot doors, ventilator valves, etc.  No opening nearer than 12" to woodwork.  No timber nearer than 12" to inside of flue or opening.   No timber under chimney opening, less than 18" from hearth surface.  No timber less than 2" from chimney face if the brick wall is less than 8½" thick, unless the wall is rendered.  No timber plugs nearer than 6" to inside of flue.  No iron holdfast nearer than 2" to inside of flue.</p>	T4.ScF	T8.c36	
			T14.c64	
			T8.c39	
			T8.c37	
			T8.c40	
			T8.c41	
			T8.c42	
			new	T8.c43
			T4.Sc.F	T8.c45
			T4.ScF	T8.c46
				T7.c11
				T16.c5
			new	
			T4.ScF	T7.c11
			new	T8.c48
T4.ScF	T7.c11 and T8.c48			
	T8.c49			
new	T7.c11			
T4.ScF	T8.c47			
cl.21	<p><b>CLOSE FIRES</b>  Floor under stove, and floor 18" around</p>		T14.c66	

	<p>it, to be of incombustible material. No pipe for smoke, heated air, steam or hot water on outside face of building next to public street. No pipe for heated air or steam to be nearer than 6" to combustible material, no hot water pipe nearer than 3" and no smoke or exhaust pipe nearer than 9".</p>	T4.ScF	T14c.66
			T7.c11 and T8.c50-1 and T12.c16
cl.22	<p><b>STAIRS</b> In public buildings, and all buildings over 125,000 cu.ft. used as dwellings for separate families, floors of lobbies, corridors, landings, stairs to be of stone or other fireproof material, on supports of fireproof material.</p>	T4.ScC	T14.c68
cl.27	<p><b>SEPARATION OF BUILDINGS</b> Every building to be separated from other building by external or party wall. Sets of rooms, tenanted separately, if in building over 3,600 sq.ft. to be a separate building and divided by party walls and arches. Building with separate entrances or stairs to tenements, to be deemed a separate building. Warehouse, or building for trade or manufacture, over 216,000 cu.ft. to be divided into compartments not over 216,000 cu.ft each.</p>		T14.c74
			T14.c75
cl.28	<p><b>UNITED BUILDINGS</b> To be united only if in same occupation, do not contravene this act when united, have no opening in partywall to make more than 216,000 cu.ft except openings not over 7'0" wide x 8'0" high, with brick, stone, iron, jambs, floor and head, two wrought iron doors, each <math>\frac{1}{4}</math>" thick, apart by the thickness of the wall, and no woodwork.</p>	T4.ScD	T14.c77
cl.26	<p><b>PROJECTIONS</b> All copings, fascias, verandahs, balconies, porches, window dressings, balustrades, architectural projections, eaves and cornice to overhanging roof (except shops and detached or semi-detached houses 15'0" min from road) to be of Brick, stone, tile, artificial stone, slate, cement or other fireproof material. Shop fronts: 5" max. projection in streets under 30'0" wide, except cornices = 13" 10" max. projection in streets over 30'0" wide, except cornices = 18".</p>	T4.ScE	T14.c73



	No wood on shop front to be nearer than $4\frac{1}{2}$ " to line of junction with adjoining premises, unless a fireproof corbel, $4\frac{1}{2}$ " wide and projecting 1" min is used. Gutters and pipes to take rainwater off roofs, flats, gutter, balcony, verandah and shop front.  No other projection without the permission of the Metropolitan Board of Works.	T4.ScG and T5.c74	T7.c22
cl.23	SPACE ABOUT BUILDINGS FOR VENTILATION Minimum height of all rooms, except attic and cellars = 7'0". Attic = 7'0" from floor to ceiling through out not less than $\frac{1}{2}$ the floor area of the room.	T4.ScC	T7.c15
cl.29	Yard to house (unless all rooms can be lighted from adjoining street) to be at rear or side, exclusively belonging to the house, of 100 sq.ft.	T4.ScK	T7.c13 and T14.c40

Miscellaneous

- Part I cl.6 Lists all exempted buildings (Palaces, Gaols, Bank of England, British Museum, East India Co. Mansion House, Guildhall, Greenwich Hospital, Lunatic asylums, cattle market, canal, dock and railway buildings.  
and  
all buildings, not over 30'0" high, not over 125,000 cu.ft not public, at least 8'0" from public street and at least 30'0" from adjoining building or ground of adjoining owner,  
all buildings, not over 216,000 cu.ft, not public, at least 30'0" from public street and at least 60'0" from building or ground of adjoining owner, all party fence walls (which were controlled under M.B.A. 1844), all  
woodwork, sashes, etc, to greenhouses,  
all openings in walls or flues, up to 40 sq in max at least 12" from any timber.
- 1st Schedule cl.6 Height of buildings to be the height of external and party wall, measured from base of wall to level of top of topmost storey. Height in topmost storey to be underside of roof tie, but to half the vertical height of the rafters if there is no tie. Height of all other storeys, to be from floor to ceiling. Length of walls - divided into distinct lengths by return cross walls, measured centre to centre (provided the return walls are external, party or cross as thickness specified in this Act).
- Part II Relates to Dangerous structures.  
Part III Relates to administration of party wall matters.  
Part IV Miscellaneous - expenses, appeals, penalties, etc.  
Part V Repeal of earlier Acts: all M.B.A. 1844 (except cl.54-63, dangerous trades etc).

all 1774 Act (14 Geo III cap.78)  
except cl.74-86, referring to  
fire-engines, ladders, firecocks,  
keepers, etc.

clause 112. Related to continuation of construction of iron buildings  
started before 1855, their legality to be decided by  
Commissioners of Works and Buildings.

---

---

HEIGHT 100'0"		HEIGHT 90'0"		HEIGHT 80'0"	
Length up to 45'0"*	80'0" any length	up to 45'0"*	70'0" any length	up to 40'0"*	60'0" any length
HEIGHT 70'0"		HEIGHT 60'0"		HEIGHT 50'0"	
Length up to 40'0"*	55'0" any length	up to 30'0"*	50'0" any length	up to 30'0"*	45'0" any length
HEIGHT 40'0"		HEIGHT 30'0"		HEIGHT 25'0"	
Length up to 35'0"*	any length	up to 35'0"*	any length	up to 30'0"*	any length

Notes: Asterick \* = If any external or party wall is not more than 25'0" centre to centre from other external or party wall and is

tied by floor beams (except ground floor or floor of storey in roof) then length of wall to be ignored and thickness of wall to be as indicated under column marked \*.

If any storey is over 16 times the thickness of walls prescribed for such storey (in height), then thickness in that storey to be increased by  $\frac{1}{16}$  part of the height of the storey - but may be confined to piers properly distributed, of which the collective widths =  $\frac{1}{4}$  length of the wall.

No storey enclosed with walls less than 13" thick to be more than 10'0" high.

For thickness of cross walls and stone walls, see Table 6 sheet 3.

FOOTINGS: in all cases:-

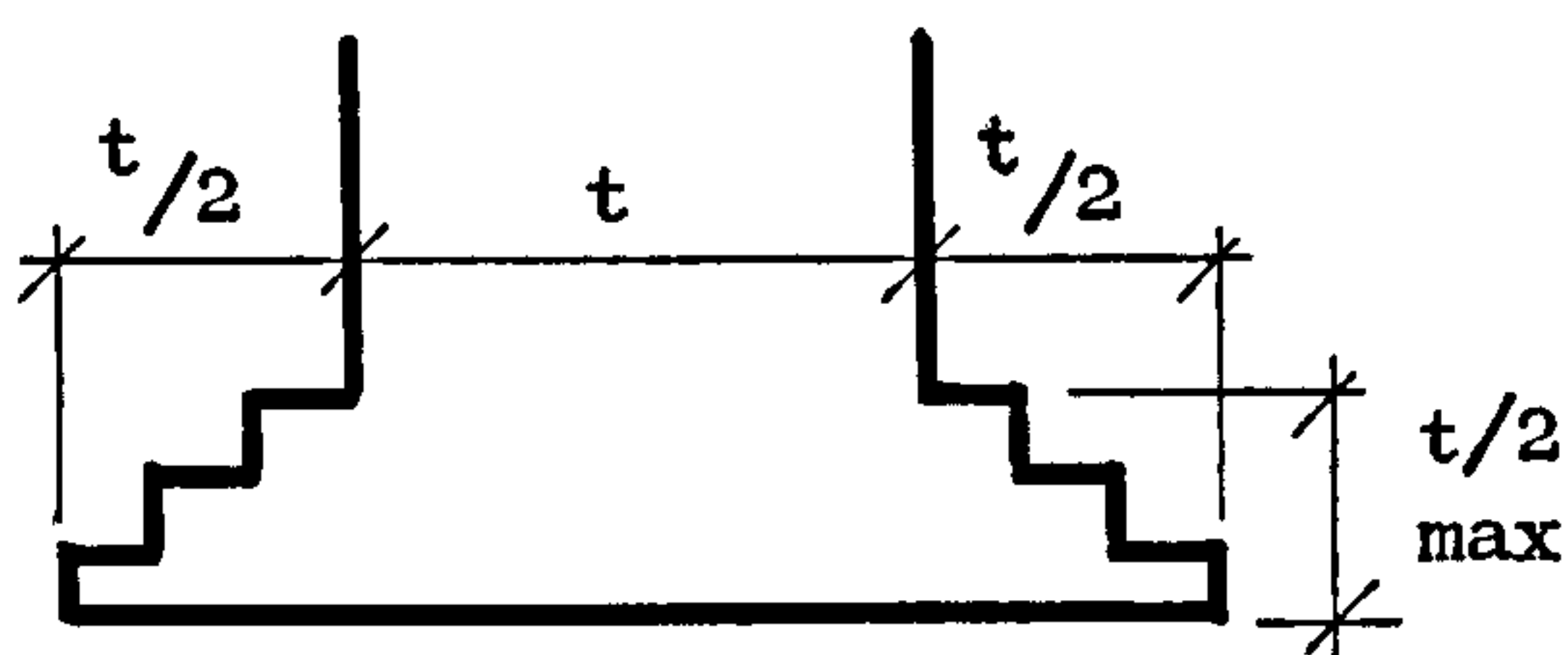

(off-sets to be regular)

HEIGHT UP TO 100'0"				HEIGHT UP TO 90'0"			HEIGHT UP TO 80'0"		
Length up to	55'0"	70'0"	any length	60'0"	70'0"	any length	45'0"	60'0"	any length
Thickness at base =	26"	30"	34"	26"	30"	34"	21½"	26"	30"

HEIGHT UP TO 70'0"				HEIGHT UP TO 60'0"			HEIGHT UP TO 50'0"		
Length up to	30'0"	45'0"	any length	35'0"	50'0"	any length	40'0"	70'0"	any length
Thickness at base =	17½"	21½"	26"	17½"	21½"	26"	17½"	21½"	26"

HEIGHT UP TO 40'0"				HEIGHT UP TO 30'0"		HEIGHT UP TO 25'0"
Length up to	30'0"	60'0"	any length	45'0"	any length	any length
Thickness at base =	13"	17½"	21½"	13"	17½"	13"

If thickness of wall in any storey is less than 1/14th the height of the storey, then thickness of wall to be increased by 1/14th the height of the storey.

The rule concerning walls not more than 25'0" apart, as described on sheet 8, also applies to warehouse walls.



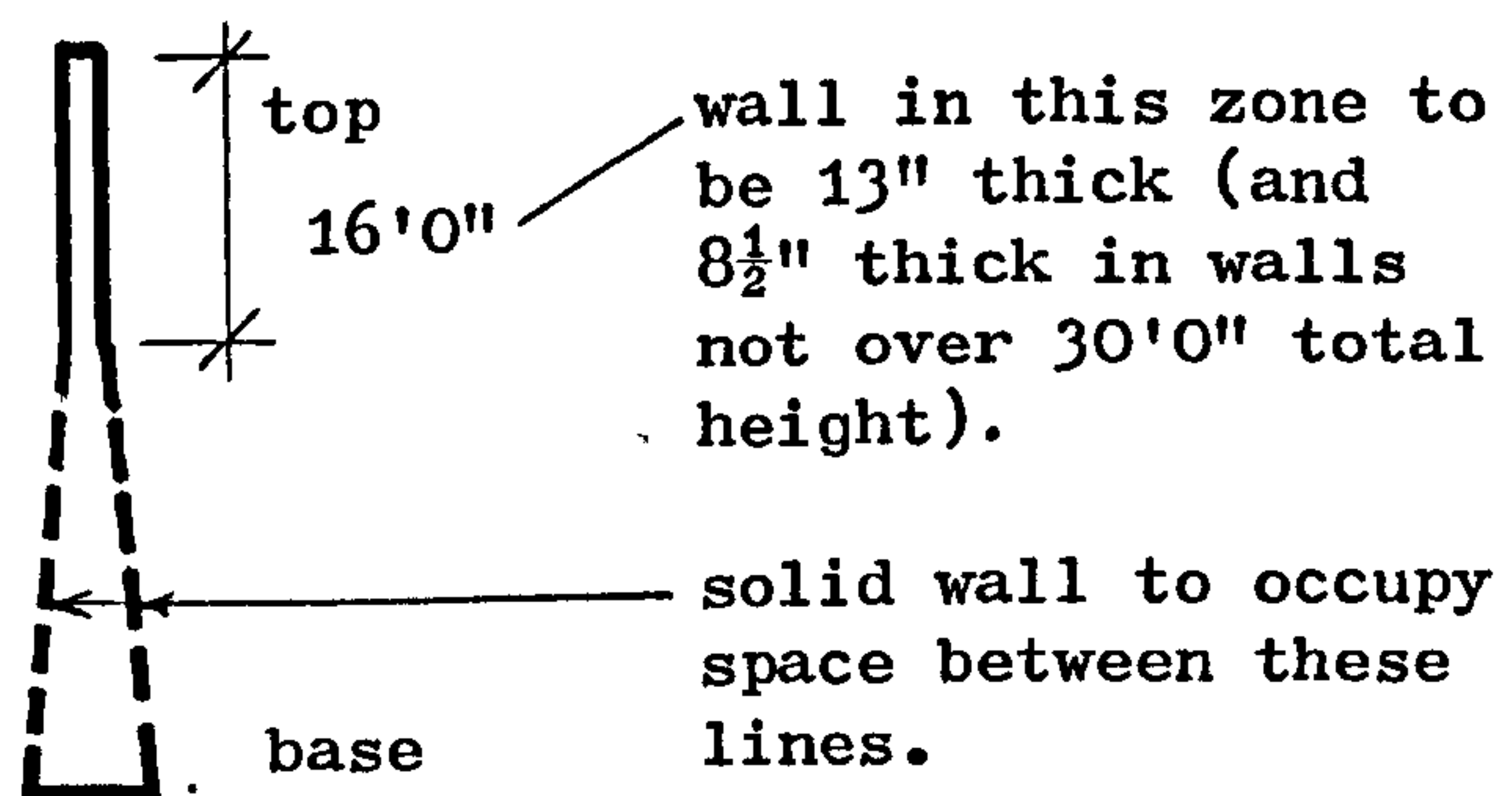

## CHAPTER V

### EARLY PROVINCIAL BUILDING BY-LAWS 1858-1875

This chapter considers the developments in building regulation outside London, between the passing of the Local Government Act in 1858 - the point at which we concluded Chapter III - and the introduction of the major Public Health Act in 1875. It parallels the activities in London which formed the contents of Chapter IV.

The chapter falls into four sections. The first analyses the 1858 Form of By-laws, the second selects and describes certain local by-laws based on the 1858 Form, including other significant provincial regulations, the third takes the development of sanitary legislation a stage further, through the Royal Sanitary Commission up to the Public Health Act of 1875, and the final section reviews the emerging pattern of a national set of building regulations.

\*\*\*

Section 34 of the Local Government Act 1858 (1) extended the range of the controls which could affect buildings and streets considerably further than those set in the Public Health Act ten years earlier (2). It will be recalled (from Chapter III, page 146) that the two clauses (nos 53 and 72) of the Public Health Act had been concerned only with the level and width of streets, the levels of houses, the control of cellars and with various provisions related to privies, cesspools and drainage work. Those two clauses were now repealed and their matter reconstituted and extended in Section 34 of the 1858 Act; powers for the making of by-laws now being granted to cover the structure of walls for stability and fire prevention, and the space about buildings for ventilation.

In November 1858 an important letter was sent to the Clerks of all the Local Boards by Tom Taylor, the Secretary of the Local Government Act Office (and incidentally, an art critic and later editor of Punch). It refers to a "Form of By-laws" - and this is of considerable significance, since this Form is in effect a 'model code' - a nationally

produced set of regulations - which precedes by nearly twenty years the more familiar and generally accepted 'first' Model Building By-laws of 1877. These 1858 By-laws are of further importance since they form the essential link between the legislation embodied in the Metropolitan Building Act of 1855 and the later Model By-laws of 1877.

The letter from Mr. Taylor read as follows:

"Sir I am directed by the Secretary of State for the Home Department to acquaint you, that having received many applications for forms of by-laws under the Local Government Act, which would serve for the guidance of Local Boards in the preparation of by-laws to be submitted for approval in accordance with that Act, the accompanying Forms have been drawn up for that purpose, in the hope that they may afford useful suggestions for the Local Boards to adopt. I am to state, however, that the Forms are confined to such points as will probably be of general application, and are issued solely in the way of suggestion [his italics]. It will be for each Local Board to consider how far the various provisions may be applicable to their own individual district, and what special conditions of modifications may also be desirable in each case".

I am Sir, Your obedient servant, T. Taylor.(3)

The letter betrays two interesting trends. First, it states that there have been "many applications for forms of by-laws", which indicates not only considerable by-law making activity at this time but also a demand from the local districts for some form of guidance from the central body. Secondly, it confirms that the central body was in fact now prepared to undertake this task and to produce a standard Form of By-laws for adoption, but there is also, and equally significantly, the proviso that these by-laws were "solely in the way of suggestion", so emphasising the still delicate matter of the degree of central interference in the activities of the local areas, as well as the realistic acknowledgement that the by-laws could be modified or adapted to suit local conditions. Such conditions were intended to cover local climatic and building practice traditions and materials - but it could also be interpreted as local political pressures as well.

The 1858 Form of By-laws was therefore a further step on the path towards a national set of regulations, even if they were presented in such a cautious and tentative manner. As a result, many of the draft by-laws included in the Form were broad in their scope, avoiding too much specific detail and giving the Local Boards ample discretionary power. So much so in fact, that these very broad terms were to lead,



as we will see later, to the breakdown of these same by-laws when they came to be put into practice. Within the Form also, the nature of the suggested by-laws was very inconsistent, some clauses being over specific, such as the minimum distance for timber plugs from the inside face of a flue; others being rather vague, leaving it entirely to the Local Board's discretion, such as in the matter of wall thicknesses.

In the Form of By-laws, the clauses are now grouped under the main topic headings of streets, structure, space and drainage - the cellar controls now, of course, remaining within the Public Health Act. Certain parts of the Towns Improvement Clauses Act of 1847 were now absorbed directly into the 1858 Local Government Act, one or two matters, as table 7 shows, being transferred to the by-law area. The Form of By-laws was a much more flexible device than the Towns Improvement Clauses Act - no special and expensive Act was required by a town; once it had adopted the Public Health and Local Government Act, it could produce its own by-laws, guided by the Form if it wished and only requiring the formal approval by a Secretary of State to become effective.

\*\*\*

#### Analysis of the 1858 Form of By-laws (see Table 7)

The Form of by-laws was produced by the Local Government Act office in London (4). It is not surprising therefore to find that much of the Metropolitan Building Act, passed just three years earlier, was taken as a guide. The bulk of the by-law follows the London pattern, but there are also one or two clauses that come from other local acts or the Towns Improvement Clauses Act. But in many cases the precise details of the clauses were modified, presumably in the light of practical experience and commonly accepted practice in the Provinces, and in many cases, left entirely to the Local Board to decide. This, as noted earlier, was soon found to be ineffective and, when the 1877 Model By-laws were produced, there was a swing the other way towards a more specific and elaborate range of regulations. These 1858 Form of By-laws can therefore be seen as a first cautious move on the part of central government as it moves into a new, uncertain and sensitive area of control.

## Streets (Table 7, sheet 1)

If we take the first area of control, namely over streets, we find two examples of regulations which had existed in the earlier Metropolitan legislation, but which are now changed from the practice current in London in 1858. The widths of streets were set at 36'0" / <sup>and 18'0"</sup> for carriageways and non-carriageways respectively, whilst in the preceding year, 1857, the new London by-laws had re-affirmed the old London standards of 40'0" and 20'0" respectively. It is true that the Form of By-laws measured the width as the area dedicated to the public, whilst in London the width was measured between the faces of the buildings, but even so, the anomaly cannot be accurately accounted for by, for example, allowing for the width of the 'areas' for cellars. The Towns Improvement Clauses Act 1847 and the Commission of Enquiry into the State of Large Towns and Populous Districts (5) had included 30'0" and 20'0" - which paralleled the requirements of Lord Normanby's Bill of May 1841 (table 3). No exact precedent with the figures 36'0" and 18'0" together has been found in any earlier legislation, although Nottingham set its carriageways at 36'0" width and Birkenhead set its courts or non-carriageways at 18'0" (see chapter III, page 135).

The second interesting clause in the topic of streets was the inclusion, in clause 3, of a regulation controlling the relationship between the width of streets and the height of buildings. Now this, as we have seen in the last chapter, had been omitted from the London legislation of 1855, yet here it is again, following closely the form it had in the 1844 Metropolitan Building Act, and now being issued for the guidance of towns producing their own by-laws. As a clause or topic, its course was to continue to be erratic. It returned to London, somewhat modified in the Amendment Act of 1862, but then it was not included in the Model By-laws of 1877. These prevarications reflect the sensitive nature of this control which, whilst originally intended to secure light and air in the streets, had a more marked effect on the density and volume of building, particularly at a time when the pressures for larger buildings were on the increase.

## Structure (Table 7, sheet 1)

Within the area of structure, it is somewhat surprising to see the

controls on wall thicknesses being left to the discretion of the Local Boards, particularly, as we have seen, so much debate had centered on this topic in London in the years immediately preceding the 1855 Building Act. It is possible that the new London rules had yet to prove themselves in practice and the Local Government Act Office felt it unwise to spread them further. Also building practice and traditions in this matter were so various and affected such a substantial and costly part of any building, it was no doubt felt that it would cause considerable resentment from the local Boards. Nevertheless, it is significant to see that this degree of caution was later seen to be unjustified, and the wall thickness regulations, based very closely on the 1855 Metropolitan Building Act, returned with the Model By-laws of 1877.

This 1858 Form of By-laws was indeed strangely erratic in its scope. There is the rule setting all timber 4" back from the face of an external wall, following the long established London control, but where are the controls on openings, recesses and chases, on parapet walls, cross walls and projections? Foundations are included, word for word from the 1855 Building Act - but there is no formula for footings. No front wall parapet was required, "dripping eaves" being now allowed, but the traditional controls on party walls projecting above the roof surface are now included - again, a long standing matter in London, but now modified to a height of 12", the same as the Towns Improvement Clauses Act and Lord Normanby's Bill of 1841, but 3" lower than the current London requirement.

The materials for walls followed the 1855 Metropolitan Building Act, as did the materials for roofs but, as in London, no mention was made of the maximum number of storeys in roofs, in spite of the increasing use of the Mansard roof. Chimneys, hearths, flues and steam pipes were all included, but in a very general way, leaving a great deal to Local Board control. Yet here again there were idiosyncracies. No timber was to be nearer than 9" to the inside face of a flue, a reversal from the 12" of the 1855 Metropolitan Building Act to the 9" of the 1844 Act : timber plugs set at 6" minimum from the inside of a flue was exactly the same as the 1855 Act, but now there was no mention of the 2" for iron holdfasts in a similar situation which had featured in the 1855 Act. Heights of chimneys were not mentioned either, yet they

certainly appeared in the Acts for London, Liverpool and Bristol, and there was still no attempt to cover timber joist and purlin sizes, as Liverpool was currently operating, though here again, it was a regulation which would have caused considerable local opposition, principally on grounds of cost.

The Form of By-laws made no specific mention of fire proof construction for public buildings, or for tenement blocks, the latter being more a problem in London than elsewhere at this particular time. The list of exempted buildings however, closely follows the London pattern, but again with certain modifications, such as the omission of bridges and piers from the list. A more positive change was made to the rule excluding small buildings from the operation of building controls. The clause (no.12) followed the 1855 Metropolitan Building Act in its general form, but the critical distances were now measured from "the opposite side of the street" (see Table 7, sheets 2 and 4). This was somewhat obscure - it would seem to allow a small building to be built close to the edge of street, if a street was 36'0" wide and no building line control operated. Not surprisingly, this rule was changed back to conform with the London regulation by the time of the 1877 Model By-laws.

#### Space about Buildings and Ventilation (Table 7, sheet 2)

Turning now to the third topic, space about buildings and ventilation, the most significant clause is number 13, which set an innovation in relating the width of a backyard to the height of the house. As in London, the space could be left either at the rear or the side and it had to belong 'exclusively' to the house, but the escape clause for a house to have its rooms lit by a side street was now omitted. The basic area was increased to 150 sq.ft.- an increase of 50% over the current London standard, but the actual length and breadth of the backyard were not mentioned, and it still was possible for a backyard to be, say, 25'0" across, yet only 6'0" wide, and still conform to the by-law. The caution of the Local Government Act office was revealed in the concession that this clause could be modified if the Local Board found that in practice it led to a "considerable sacrifice of property". The concern for the rights of property and fear of the economic consequences was as alive as ever. The actual idea of

proportioning the size of the yard to the height of the house was not in itself new, since it had been suggested in the evidence to the Select Committee enquiry into building regulations back in 1842 (6), but the 1858 Form was the first time that it appeared officially as a recommended regulation.

The minimum height of rooms was now included although, as we have seen in the last chapter, it was to be considered later to be 'ultra-vires' and was removed from the Model By-laws of 1877. Set at 8'0", it was 12" higher than in London, for all rooms, except the attic and cellar - the attic to be 8'0" over not less than half its area (the same formula as in London) and the cellars were held at 7'0" by clause 67 in the 1848 Public Health Act. Liverpool had already been operating these dimensions of 8'0" in general, 7'0" in the cellar, but the attic there was 7'0" - as in London. Liverpool had also operated a rule requiring every habitable room to have a window. This now appears in the 1858 Form of By-laws, but with the modification which brings in for the first time the requirement for the size of the window to be at least one-tenth the area of the room. This incidentally is the third of what may be termed the proportional relationship controls included in the Form of By-laws, the other two being, as we have seen, the control between the street width and building height, and the control between the distance across the backyard in relation to the height of the building.

The top of the window being set at 6'7" (clause 16) above the floor level is a curiously precise dimension. Why 6'7" exactly? No reason is given, but it seems to be nothing more than a misprint for 7'6", a more reasonable dimension, and one which is used for exactly the same regulation in both the Sheffield by-laws of 1864 and Manchester of 1867. The requirement for the upper half of the window to be openable had, of course, appeared earlier, for example, to control cellar windows in the 1844 Metropolitan Building Act. But the requirement for small rooms under 100 sq.ft, without a fireplace or window, to have a 'special means of ventilation' is new, and is to be taken further in the 1877 Model By-laws. Similarly, the ventilation of public buildings is a rather specialised topic, but it will be recalled that the Report of the Commission into the State of Large Towns and Populous Districts had laid great emphasis on this matter, and it had

emerged as a rather singular item in the Towns Improvement Clauses Act of 1847. Here it is again in 1858, somewhat modified, but still obviously considered to be of particular importance, and it duly re-appears in the 1877 Model By-laws.

#### Drainage (Table 7, sheet 3)

Here the point to note is the general elaboration of the range and details of the regulations. The need for all materials and the method of drainage to be approved by the Local Board would, no doubt, have been welcomed by Dr. Liddle; the specification of glazed stoneware or fireclay, with water tight joints, would show a better understanding of the technical functions of drainage - although the allowance for drains to run under houses in well-puddled clay was perhaps not as ideal as the later alternative of concrete. Ventilation of the drains by means of a rainwater pipe was allowed at this time, although, as we have seen in the previous chapter, this was not considered to be good practice and was later forbidden. Roof drainage and the need for drains to have traps had their precedents in London as well as in other local acts, but the requirement for the proper drainage of damp sites is now new, although, in spite of calls from many critics, there was no requirement for a cover of concrete over the site of a house. The ventilation of the w.c. or privy to an 'opening near the top, connecting with the external air' tended to result inevitably with the planning of a w.c. inside a house to be adjacent to an external wall.

These therefore are a selection of some of the more significant clauses in the 1858 Form of By-laws. We can now turn to study the pattern of building by-laws as they were framed and operated in certain provincial towns in the period between 1858 and 1875.

\*\*\*

#### Provincial Building By-laws 1858-1875

A number of provincial towns issued their own sets of by-laws, under the powers of the Local Government Act of 1858 and modelled them closely on the pattern established in the 1858 Form of By-laws. As examples three Yorkshire towns have been selected : Doncaster, Bradford

and Sheffield.

The Doncaster building by-laws were confirmed by the Home Secretary in November 1860 (7). A great deal was taken directly, word for word, from the 1858 Form, including the nature of wall materials, foundations, the fixing of steam pipes, the space about buildings, drainage and ventilation clauses. But there were two local modifications. One was for the minimum street width to be 30'0", rather than the recommended 36'0"; the other was to allow timber to approach to within  $4\frac{1}{2}$ " of the inside of a flue, the Form of By-laws having recommended a figure of 9" - and in London, it was as much as 12".

Bradford had also produced a set of building by-laws in 1860, again largely based on the 1858 Form. It had had earlier legislation - an Improvement Act in 1850 and regulations for overcrowding of sites, ventilation and privies in 1854. The Building and Improvement Committee reviewed the local situation in 1853, concluding that "no material improvement can be effected in the humbler class of dwellings unless the operation of building speculators can be restrained by some more stringent powers being placed in the hand of the governing of the town" (8).

The new by-laws of 1860 were however, as a report of 7 March 1864 noted, "proving effective against the evils, although it had to be admitted they tended to increase the cost of houses for the working classes, but this should not be an argument to justify back-to-backs" (9).

The most significant of the Bradford by-laws was the one relating the area of the backyard to the height of the houses. Not only did the distance across the open space increase in proportion to the height of the houses, but also the actual area of the space itself, from a basic 150 sq.ft. to a magnanimous 225 sq.ft. (10). This appears to be the only instance of an adjustment of this area - Hole (11) shows the comparison in a table taken from the Bradford Report on building by-laws, and reproduced here in Table 7, sheet 5. This table, besides giving a contemporary and illuminating example of the range of controls in this area, also shows that a number of towns were safely following the standard set by the 1858 Form of By-laws. The Bradford standard is, relatively, very high - even the 1877 Model By-laws could not match this.

Sheffield produced its first building by-laws four years later, in 1864, soon after adopting the Local Government Act. These by-laws were almost exactly the same as the 1858 Form. Five modifications were made by Sheffield however. The width of a non carriageway was set at 21'0" (not 18'0" as the Form suggested); the provision for party walls to go through the roof was omitted, it not being a local building practice; the distance of timber from the inside face of a flue was reduced from the 9" in the Form of By-laws to a mere  $4\frac{1}{2}$ ". The clause on the ventilation of house drainage was omitted, and finally, room heights were set at 8'6", rather than 8'0". Sheffield's by-laws remained virtually intact until 1889 - the only change in the interim period being in 1880 to the clauses concerning penalties and fines, for not conforming with the by-laws or for not giving proper notice. The account of Sheffield's by-laws is resumed in chapter VI (see page 304).

If many towns, like the three selected above, went ahead and produced by-laws on the 1858 Form, it was soon found that they were by no means so effective or so well received as had been hoped. Let three further examples taken from 'The Builder' between 1865 and 1871 suffice. In Halifax it was said that, following the Corporation's by-laws of 1864, the cost of Second or Third class houses would inevitably rise, because of the greater quantity of land required (to accommodate the backyards), the walls would have to be a greater thickness, and as for the provision of an ashpit and privy to each house, 'an expensive and unnecessary luxury', these would add 25% at least to the cost of each cottage (12). At Shrewsbury, the enthusiasm of the Town Council was most commendable. By-laws for sewers, drains, w.c.'s and cesspools appeared in 1866 but, as the local architects and builders had to point out to the Council, "it was most inopportune, since no general sewerage system yet exists" (13).

The 99th by-law at Acton, based on the 1858 Form, ran thus: "The walls of every new building shall be constructed of such thickness as shall be approved by the Local Board, and the foundations shall rest on solid ground, or upon concrete, or upon other solid substructure". To Mr. Ewan Robertson, a local carpenter, this was

"the invention of a partially diseased brain .... it was a law belonging to the feudal ages, not of the nineteenth century .... it meant that



one builder can build a  $4\frac{1}{2}$ " wall, to whatever height he like, another builder can be compelled to build his garden wall 18" thick .... Again, Mr - has built his house on soil turned over four months before, 10" deep, sowed and planted with peas and cabbage. There are no footings, and no concrete was used. It was inferior to Highland Cots or Irish cabins .... How is it that Mr - has been compelled to carry his party wall through the roof in accordance with by-law 101, whilst Mr -, in Grove Place, builds three houses without the said walls?" (14)

The picture emerges therefore of a number of towns dutifully framing building by-laws, but finding not only obstacles from the local builders and architects, but also severe difficulties in enforcing the by-laws and supervising the new buildings under construction. Furthermore, as the evidence to the Royal Sanitary Commission in 1869 was to show, there was a growing realisation throughout the country that the actual by-laws themselves were nearly all legally invalid. Mr. Notcutt, the Town Clerk of Ipswich, referred directly to the 1858 Form of By-laws in his evidence to the Commission. Those at Ipswich were based on the 1858 Form, and they had nearly all been found to be invalid.

"They attempt to give Local Boards more power than they are entitled to .... and left much to the Local Board to determine .... This was held to be beyond the powers given by the 1858 Local Government Act. An Act of Parliament could give Local Boards power to determine street widths for example, but a by-law could not". (15)

Even when a by-law had been found to be invalid, the Local Government Act office had suggested an alternative - but that again, had been found to be invalid. (16).

Notcutt quoted four cases where decisions against local by-laws had been decided by the Courts. They are included here since, although it is not the intention of this thesis to stray too far into the legal world, they do reflect the characteristics of these early by-laws: a lack of precision, ambiguity and a tendency to contradict Statute Law, or being simply unreasonable in their demands. (For the discussion of the precise nature of the by-law, see Chapter III, page 132 )

The first case concerned the Garston Local Board, which had a by-law requiring either a roadway or a back street 12'0" wide to every house, to give access to the privy (for cleansing). But clearly, if the house had a w.c. and no privy, then no roadway was required: the by-law was badly framed and was held to be defective (17). In the second

case it was held that a person, after giving due notice, had the right to commence building whenever he pleased, subject to the right of the Local Board to pull down or alter the building if it contravened their by-laws (18). The third case confirmed that the Local Board had no power under Section 34 of the 1858 Local Government Act to make a by-law relating to buildings erected before the date of the constitution of the district, or to the closing of such buildings when unfit for human habitation, or to the prohibition of their use for such habitation (19). This was a severe set-back; the number of districts which were properly constituted was limited, and the Local Government Act Office, in a circular dated June 1864, referred to this case and cautioned Local Boards not to attempt to put by-laws into operation except for buildings erected in the district after the adoption of the Local Government Act. Finally, there was the case where a town's local by-laws, modelled on clause 33 of the 1855 Form of by-laws, imposed pecuniary penalties on anyone not complying with the by-laws (20). This was held to be 'ultra vires', a bad by-law, and a circular from the Local Government Act Office was issued in May 1864 to all local Boards pointing out that clause 33 could "no longer be supported" - and thereupon issued a revised version of the offending clause (21).

If we take a single topic which the by-laws attempted to control, and select four cases where the by-laws failed to perform properly in this respect, these will serve to illuminate further the difficulties experienced in formulating and operating the by-laws. The topic selected is the provision of open space for a house. One case confirmed that the Sunderland by-laws had not been violated in 1861, concerning the provision of open space to a dwelling adjoining a back street, since in the first place there was no new building erected within the Local Government Act of 1858, but only an addition to an old building, and secondly that the words "back street" were held to be read only as "new back street". (22) A second case held that the same by-law, if applied to old buildings, was bad as it exceeded the powers conferred by the Local Government Act of 1858 (23). A third case determined that the space required to be left between the building to be erected and the opposite property must be co-extensive with the line of demarcation between the building and the opposite property, and that at no point should a less distance than that prescribed by the by-law intervene between them, exclusive of any common passage (24). Finally

at Hull, under Section 99 of its Local Improvement Act of 1854, admittedly not strictly speaking a by-law but nevertheless attempting to control this same topic, it was stipulated that "every house to be constructed shall have a backyard or other vacant ground or area from the ground upwards of not less than 8'0", extending from the main building for the whole length of such building" (25). Pearson, a local builder, was summoned for failing to provide this space at the back of a house. He was fined; the court in its wisdom was here "inclined to think" it pointed to a yard at the back and not an open space at the side of the house (26).

Not all towns of course produced by-laws following the Local Government Act - a number continued to operate under their own local Acts. This sometimes led to confusion. At Bristol for example, the local building and Improvement Act was still in operation, but the Public Health Act of 1848 had been extended to Bristol in 1851, and consequently the Local Government Act of 1858. One poor builder named Morgan failed to pay the requisite fee to the District Surveyor, believing, incorrectly as it proved, that the General Acts over-ruled the local Acts (27).

Manchester created its own by-laws under its own Improvement Act of 1865. They largely conformed however, with the 1858 Form of By-laws. By-laws for the top height of the window, for ventilation for public buildings and for special ventilation for rooms not having a fireplace were identical (28). The Manchester Society of Architects were particularly active in a campaign for the reform of these by-laws in the 1860's. They saw them as being of "an arbitrary nature" and had some limited success, purging them "of a much objectionable matter". They added that they hoped that they had:

"benefited other localities as well as our own, it being very much the custom of officials in one town or district to obtain copies of the by-laws in use elsewhere, and to adopt them 'verbatim et liberatum', so that the very typographical blunders are even repeated" (29).

What Manchester does today, England does tomorrow, perhaps, but an interesting glimpse of the way in which by-laws were copied from one town to another, a continuation of the same process, in the same area incidentally, that has already been noted in connection with the earlier local acts (see Chapter III page 128). Between 1867 and 1872 the local Society of Architects tried to induce the Corporation to

codify all the sections of the various Acts of Parliament relating to building controls, as well as to frame additional by-laws, and to produce a satisfactory Building Act (30). They tried specifically to persuade the Council to adopt "such building regulations as would have the effect of a Building Act" (31). But their efforts were not too successful, if one can believe Mr. Grimes' views when he addressed the Manchester Scientific and Mechanical Society in 1875 - the year of the great Public Health Act. He said that Manchester had few building regulations and the Corporation exercised little authority over construction. He particularly noted the lack of controls on materials, the lack of a requirement for concrete foundations, and the lack of control on timber in houses. He referred his audience to the by-laws of the Metropolitan Board of Works in London - "no complaints having been heard against them" (32) - a somewhat surprising statement when one recalls some of the views expressed in London at that time. (see Chapter IV, pages 176 and 182).

Across in Liverpool, there was considerably more activity as a succession of amending bills and new acts were produced. 1854 had seen the Sanitary Amending Act (33) which, amongst other matters, had eased the procedure for connecting house drains. 1858 saw an Improvement Act (34) which, under clause x, gave the Corporation powers to approve the design of the elevations of new buildings in any of the streets improved under the Act - an early aesthetic and planning control which was to be perpetuated in the Improvement Act of 1861 (35).

Earlier, in 1856, Joseph Boult had addressed the Liverpool Architectural and Archaeological Society on the nature of the Building Acts:

"It is impossible to frame on the Model of the Medes and Persians any enactment relating to building construction. It is progressive art, continuously varying, both in the materials applicable to its purpose and in the modes of using materials already so applied" (36).

He felt that the local surveyor must have discretion, and a special jury must decide the technicalities of a case brought under the Building Act - and in that, of course, he was supporting the role of the London District Surveyor and the proposed Court of Building in London. Whilst recognising that the worst standards of construction were in the cheaper and smaller classes of property, and that it was relatively easy to frame regulations to cover them, when it came to "superior houses, shops, mercantile and public buildings", he considered that

it was difficult to be too specific. For these cases "the more judicious course would be to prescribe certain wide limits within which each individual should be at liberty to exercise his own discretion" (37). It might not be unreasonable to say that, for his time, Boulton had probably the most realistic and sensible view of the nature and function of building regulation.

In 1860, when the Liverpool Corporation Health Committee proposed a set of new building by-laws, the local architectural society, like its Manchester counterpart, gathered to discuss and criticize them. John Hay reflected the view that the profession then held of its own importance - and of its view of local officialdom. Architects should not, Hay protested (and how often has this been repeated), have to be accountable to the Borough Engineer and his subordinates. The law made no distinction between the elite and lowest rank in the building world - between, as he said, Sir Charles Barry and the lowest 'jerry builder'. A Mr. Weightman rose to object to all the proposed by-laws, particularly the restriction on the use of iron for the support of a superstructure and the imprecise definitions of 'solid ground' and 'sufficient concrete' for the foundations. The Society resolved to ask the Town Council to postpone the by-laws for another month, to give architects and others more time to consider them (38).

Four years later, in 1864, the Sanitary Act was amended (39), a clause being included to require new courts to be open at each end for the full width. Retained also from the 1846 Act was the clause relating the number of houses to the width of the Court. The open space at the back of a house was now brought up to the standard of the 1858 Form of By-laws, setting 150 sq. ft. as the minimum area 10'0" across between the house and rear wall of the yard, and increasing to 30'0" in width as the number of storeys in the house increased. This was rather a late recognition of what many other Northern towns had already implemented but it is worth noting, just to point the contrast and to show the range of variations in this matter, <sup>that</sup> the Liverpool area (150 sq. ft.) was over twice that of the equivalent by-law in Manchester (70 sq. ft.), which was passed three years later.

A competition for the design of Labourers' Dwellings in Liverpool in

1867-8 brought the subject of its local building regulations to the attention of the rest of the country. Although the requirements for street widths and the distances between houses were supplied to the competitors, the relevant Building Act of 1846, was out of print and impossible to obtain. Many of the entries were therefore not in conformity with the Act, but were rejected out of hand by the panel of judges. 'The Builder' called the old Act - and it was over thirty years old - "PreAdamite" and "full of inconsistencies". For example, it appears that the rule regulating the height of building in relation to street widths did not apply to the competition site, where the buildings could go up to the full height of 65'0" allowed by the Act, regardless of the width of the streets surrounding the site. "Either the by-law is of use, or it is not" 'The Builder' insisted (40). The economic pressure to get as many houses on the land as possible caused the Corporation to waive its own by-laws (41) and the Scheme, as eventually built (St. Martin's Cottages, Blenheim Street, Vauxhall Road) infringed at least one of the 1864 by-laws by allowing a closed court to be entered from one transverse passage only (42).

These infringements and the consequent scandal led to the setting up of a sub-committee in 1869 to study the working of the local Building Act and the Liverpool Architectural Society was asked to consider possible amendments (43). Their report of 1869 is of interest, since it shows how far Liverpool had fallen behind the standard of regulations elsewhere. The by-laws of the Local Board in the neighbouring district of Toxteth were considered in comparison. The Liverpool wall thickness regulations, made under schedule A of the Act of 1846, were now considered to be inferior to those at Toxteth. Toxteth took account of the height, the number of storeys and the distance between intersecting walls. This was felt by the Architectural Society to be, quite correctly, an altogether sounder principle than the old system based on areas and rates of houses which still operated in Liverpool. Although Toxteth copied the 1858 Form of By-laws in requiring party walls to project above the roof level, this regulation was not apparently enforced there (indeed, outside London, Liverpool and Bristol, this practice was very rare). The Liverpool architects felt that this was acceptable and could see no harm in Liverpool now falling into line - it would be quite adequate for the walls to be properly lined up to the underside of the slating. The cost implications of the old Liverpool Act, in terms of

wall thicknesses, parapet walls and timber sizes were also considered. The Corporation proposed to increase one of the timber regulations from a 6" x 2" joist spanning 10'0" to an 8" x 2" over the same span. This, besides being one third extra in the amount of timber, tended to increase the height of the storeys and therefore the cost of the building. The same Bill proposed by the Corporation also prohibited more than one storey in the roof, but as we have seen in the last chapter, this had already been omitted from the London regulations in 1855 and the increasing use of the Mansard roof had effectively ended its usefulness, at least for the time being. The Bill was also particularly severe on the matter of projections: 3" only for "architectural decorations" not below 10'0" above the pavement level, and no cornice, coping or balcony to project more than 18" in streets not over 30'0" wide, and 2'0" in streets over that width. The local architects were naturally appalled. As they pointed out, the Liverpool and London Chambers had a main cornice projecting 3'0" and the Exchange Building had cornices of 2'3" and 2'6". The fear was that such regulations would tend to "restrict the architecture of the town to one type". Finally, iron instead of wood was decreed for bressummers and a blow was dealt at stone lintels: "every opening above 2'6" in width which is not arched over throughout the thickness of the wall, or which has not an iron lintel, shall have a discharging arch of brick or stone" (44).

It would appear from this evidence that Liverpool, having been in earlier years in the van of the promotion of comprehensive building regulations, had now fallen behind the standards elsewhere. In a similar way, the London regulations were, by the time of the new Model By-laws of 1877, also considerably out of date. This may be a reflection of a number of aspects: first, the very nature of the legislative device, the expensive and restrictive nature of a proper Act as opposed to the more flexible mode of the by-law; secondly, a jealous maintenance of a civic pride in its own particular legislation; thirdly, the fact that these two cities had been built up so quickly and to such a density that their problems were seen, by them, to<sup>be</sup> more acute and more specialised than elsewhere; and, finally, the suspicion of any interference or control from central government.

\*\*\*

Developments in Health Legislation 1859-1875, including the Royal Sanitary Commission Report 1869-1871

The ten years preceding the Royal Sanitary Commission enquiry - that is, between 1859 and 1869, saw a succession of new or amending acts in the field of local government and public health. The Local Government Act of 1858 was amended in 1861 (45) giving powers to assist towns to meet the costs incurred in adopting the Local Government Act, partial adoption to any local authority that desired such a course of action, and an extension of the powers for sewerage control and lighting power, now to extend beyond the boundaries of the Local Board itself. The effect was a general broadening of the scope and a more flexible interpretation of the original legislation - although it was not necessarily well received in every quarter. The local surveyors for example, having no scale of fees of their own, found themselves being underpaid under the new and more involved rules, and became very reluctant to carry out their duties, particularly in the vital area of streets (46). The Act was amended again, in 1863 (47), this time to prevent the adoption of the 1858 Act in places where the population was less than 3,000 unless approved by the Secretary of State - a device which had the effect of confirming the urban character of this particular legislation. A further very minor amendment was made in 1864 (48) and the rate of the adoption of the Act steadily increased. In 1864 for example the towns adopting the Act ranged in size and location from Cocker mouth, adopted in January, through Sheffield, adopted in July, to Bishops Stortford, adopted in October.

Three further areas of new legislation, peripheral to our main theme, but having an indirect bearing, and serving to illustrate the continued growth of more health controls from central government, albeit in small increments, may be noted in passing here. The Nuisances Removal Amendment Act in 1860 and 1863 (49) retained the Board of Guardians rather than the local authority as the controlling body for implementing these Acts; the Sewage Utilization Act of 1865 (50) saw the introduction of health controls into the rural areas, since it ensured the disposal of the district sewerage for agricultural purposes and the prevention of stream pollution, and an Act with the same title in 1867 (51) increased these powers still further, allowing sewerage to be distributed outside the district boundaries and allowing Boards or



Districts to combine to give greater effectiveness and efficiency. All these were moves towards rationalization, towards consolidation and towards the gradual recognition that the problem of health control was not only an urban matter.

The most significant new piece of legislation to come in this period immediately prior to the Royal Sanitary Commission enquiry, was the Sanitary Act of 1866 (52). This amended and consolidated the earlier Nuisance Removal Acts and Sewage Utilization Acts and contained two important innovations. First, it gave the Secretary of State power to carry out any duty which a recalcitrant local authority had neglected to do - and to charge that authority for the cost of the work done; secondly, it applied to London as well as to the rest of the country, and at last gave London a form of central authority over the various and diverse local parishes and vestries. A local authority could no longer choose to ignore the health powers, the tightening hand of central control was now increasingly being felt. 'The Times' hailed it as "A Great Sanitary Victory .... it forces the attention of local authorities to it, instead of leaving it to their option" (53). This was a new principle in any legislation - and behind it all was the forceful figure of John Simon. A second Sanitary Act in 1868 (54) extended the powers of the Public Health Act with regard to the removal of house refuse to all sanitary authorities, a small but further significant example of the ever widening sphere of control.

In 1869, because of the disconnected and conflicting nature of these successive additions to the health field in the Statute Books, pressure was brought to bear for some form of reform and enquiry into the whole nature and administration of this area of law. In response to this pressure yet another Royal Commission, that favourite Victorian device so often employed to meet such problems, was duly established, its task to enquire and report on the sanitary administration of the country, but excluding London once again.

The Commission found that there were some fifteen general acts relating to sanitary matters on the Statute Books, not to mention a host of local acts as well as parts of the Clauses Acts of 1845-7. Over 700 districts had, by 1870 in both urban and semi-rural areas, exercised the powers of the Public Health and Local Government Acts of 1848 and

1858 respectively. As the Commission noted:

"Notwithstanding this wide application of Sanitary Statutes, there are still many places with very defective sanitary government, and still more with practically none at all, owing to the defective exercise of the powers which the law confers" (55).

The report laid the blame for the insanitary state of so many districts on three factors: first, the permissive or adoptive character of the law; second, the need for proper inspection and third, the multiplicity of 'ad-hoc' bodies, particularly in the country districts. Furthermore, there was no one central body in overall control, responsibilities being shared between the Poor Law Board, the Home Office, the Medical Office, the Privy Council and the Board of Trade.

The Commission's recommendations may be summarized as follows (56):

1. A single authority for responsible control in each town (this would be the Town Council in a Municipal Borough, or the Local Board in Towns with more than 3,000 inhabitants)
2. The Poor Law Guardians to be made the responsible authority in rural areas - their district being the same as the Poor Law Union boundary (see page 142)
3. The permissive character of the Public Health Act to be changed, to allow the central authority, on its own initiative, to impose a 'sanitary organisation', regardless of the wishes of its inhabitants.
4. The establishment of a strong central Board of Health with the Poor Law Board - as a new body to administer both the health and Poor Laws. This central body (the later Local Government Board) would have powers to issue orders and regulations which would be binding on the local authority and it would also have control over local expenditure - but the delicate balance between central and local government was still present and it was stressed that the central body would be largely concerned with giving guidance and advice only, the day to day business of local government being left to the local authority itself.
5. The appointment of an independent Medical Officer of Health for each local district, with responsibility direct to the new central authority only.

None of these recommendations were to be ignored in the subsequent attempts to frame new legislation, but before following those subsequent developments which eventually resulted in the great Public Health Act of 1875, it is necessary at this point to look more closely at the Royal Sanitary Commission's Report, particularly at the evidence and recommendations concerning the building by-laws.

The evidence of Stephen Notcutt, Town Clerk of Ipswich, has already been referred to earlier in the account of the implementation of the

1858 Form of By-laws (see page 233). In essence, he favoured a new general act, but with by-laws being used in a supporting role to cover local detailed variations (57). Joseph Heron, Town Clerk of Manchester, disapproved also of the 1858 Form of By-laws and the ineffective powers given to make such by-laws (Manchester operated by-laws made under its own Improvement Act), but he approved of the principle of building by-law control, with the proper force of law and the approval of the Secretary of State (58). He considered that the Bradford building by-laws, (to which we have referred earlier on page 231) were altogether too stringent and had been very difficult to implement. In fact, according to the evidence of James Rainer, Town Clerk of Liverpool, they had had to be relaxed for a time in the face of local pressure (59). Yet the need for some form of control was generally accepted. Indeed, one witness, the Town Clerk of Halifax, wanted the powers extended to cover houses that were already built (60).

The Commission also considered the technical details of the by-laws. The suggestions of the Medical Officers of Health in London were received - their letter of 11 February 1870 was attached as an appendix to the Report. Their campaign has already been mentioned in Chapter IV. In detail, they sought a 6" site cover of concrete, controls on materials for walls, drains and mortar, the need for an open space (still at 100 sq.ft. on the London model) to each house, though with its distance across set by the relative height of the house on the model of the 1858 Form of By-laws; room heights at 8'0" minimum and rooms to be lit and ventilated by means of at least one openable window.

The bulk of the evidence on the building by-laws focussed however on the case of the rural cottage. Rural slums were totally outside any form of building control. Whilst the urban controls had been consolidated and some signs of improvement were becoming visible in spite of all the difficulties, the rural situation was still almost mediaeval and, in its own way, equally as horrific as its earlier unregulated urban counterpart (61). Tom Taylor of the Local Government Act Office wanted the by-law system extended to control drainage in rural areas (62); the Rector of Ingoldisthorpe in Norfolk wanted all cottages to have openable windows (63) and Rowland Winn, a Lincolnshire M.P. wanted the room sizes in cottages controlled (64). J. Bailey Denton, of the General Land Drainage and Improvement Company even went so far as to

produce his own complete set of by-laws for cottages (65). This particular offering had one novelty - the need for one room at least to have a boarded floor - but it otherwise contained the more familiar topics, including the still much sought for damp proof course. His proposed clause for this was "all walls should be built with a damp course above the ground line, to prevent the rising of moisture within the walls above ground". From the evidence of others, the following matters of detail were suggested as being in need of control: the drainage of sites (66), the thickness of walls, the size of living rooms, the height of rooms, size of windows, partitions between bedrooms (a curious matter, but presumably a control on the morals of the tenants), water supply, spouting and privies and, the first ever reference to staircases in any proposed building regulation, the control of the rise and the going of stairs (67). Whilst it was felt that the size of rooms should be controlled (68), the proposal to control the actual number of rooms was not felt to be justified (69).

The Commission, after assessing this evidence, recommended building by-laws of a relatively simple character for the rural districts - without the need for the plans to be approved by the local authority. "By-laws simpler than what?" asked 'The Builder' scathingly - "they have yet to be made, and experience shows, when they are proposed to be made, some excuse will be found for not making them" (70). The reason for this delicate handling of the rural situation was the fact that cottages were mostly a part of farm accommodation, without, in many cases, rent being paid for them. The Commission concluded:

"this renders it exceedingly undesirable to impose any unnecessary restrictions on cottage building which would render the landlord less willing to expend his money without profitable return, but it is right that in all cases such restrictions as are necessary to prevent unhealthy cottages being erected should be enforced" (71).

In the event, such caution, such concern for the rights of property and such lack of real conviction, resulted in the matter being taken no further at this stage. Controls on rural cottages were not introduced until the end of the century. (see chapter IX, page 444).

A second principle that the Commission generally agreed to, but were loathe to impose, was the need to licence new buildings before they were occupied. Charles Wilson, Clerk of the West Ham Local Board, had quoted a local by-law there which allowed the inspection and

licensing of houses for habitation (72). As the Commission stated "we agree with Lord Penrhyn... that much may be trusted to the rapid advance of public opinion to carry out improvements without public coercion" (73). They did recognise however, that the controls on cellars were proving to be very difficult to enforce and recommended that the Public Health Act of 1848 be rephrased to effectively control this matter.

The problem of the nature and function of the by-law, as a legal instrument, was discussed at length by the Commission. The conclusion reached was that "on the whole it may probably be the preferable course to retain the regulations as to by-laws in nearly their present state. Whilst many sanitary subjects may be specifically provided for by Statute, and some may be best left to the discretion of the local authority, there will still remain a large class to be dealt with [as now] by means of by-laws. We conceive the principle to be followed is this, that matters which require to be adapted to varying times or localities, or are too minute for general legislation, are the fitting subject for by-laws" (74). This was the key decision that was maintained, for almost the next hundred years, to ensure that the proper instrument for controlling the detailed matter of building was the local building by-law. More immediate to this account, it ensured that the Model By-laws of 1877, based on Section 157 of the Public Health Act of 1875, followed in general format the pattern outlined in the Form of By-laws of 1858.

The Report restated the principles of Section 34 of the Local Government Act of 1858, upon which the regulation of new streets and buildings was based on the concept of by-law control, with certain modifications outlined in the next paragraph. As for the rural areas, it was recommended that the street controls should not apply (75), nor that the matter of building lines and bringing building forward of adjacent building should apply (76).

Within Section 34 of the 1858 Local Government Act, relating to the control of building matters, the clause in sub-section 'b' was now extended to include ground floors' and the phrase "prevention of fires" was extended to read "the prevention of damp and of fires". In sub-section 'd', the following phrases were added: "for securing dryness

of site", "earth closets", and "for securing proper facilities for employing and cleansing the same". The reference to the closing of buildings unfit for habitation was now omitted, the matter being transferred, as they proposed, from the by-law area to the area of Statute Law. The Commission also proposed a fifth sub-section, 'e', which read "with regard to providing the adequate means of ingress and egress in the case of all buildings used for public worship, public entertainments, public meetings and the like" - quoting a local act at St. Helens as an example (77) - which shows that not all local acts were antique or irrelevant. But this clause 'e', an extremely useful safety measure, was not taken further, possibly because of the difficulty of defining "adequate means" in a watertight by-law.

Finally, the Commission proposed that the local authority should approve or disapprove all plans within one month - and neglect to do so would be taken to be an approval. This was a new requirement, but the principle has survived, with modifications, to the present day. They also added that no plans were required to be submitted in rural areas, but a power to fine in case of violation of a by-law should be included; and that the space around building left for ventilation (light not now being mentioned) should not be encroached upon without the approval of the local authority.

Immediately following the publication of the Royal Sanitary Commission Report in 1871, the Chairman of the Commission, Sir Charles Adderley, called on Gladstone's Liberal government to introduce one comprehensive Act "to render uniform, general and active the powers of local government in every place, under the inspection and stimulus of a central authority" (78). By cruel coincidence, a smallpox epidemic was scouring the country at that time: in fact, in May 1871, 288 people had died of it in one week (79). It was in the face of such pressures and a political move to show a quick response to the recommendations of the Commission, that a new Public Health and Local Government Bill was introduced into the Commons by Adderley in July 1871. It attempted to consolidate all the existing related legislation, but it was too hastily prepared and the government had insufficient time to consider and amend it (80). Besides, Gladstone had little enthusiasm for the health or local government cause. The Bill

was withdrawn on 1 August 1871. More successful however, was a separate bill framed to establish just the Local Government Board, first read on 6 July and receiving the Royal Assent, in a remarkably short period of time, on 14 August 1871 (81). The Local Government Board was to be the central authority created by government, for the supervision of the various sanitary authorities in England and Wales, including London. It was not a representative body, but a department of government, its first president, Sir James Stansfeld, being appointed by the Queen, with ex-officio members including the Lord President of the Privy Council, the Secretaries of State, the Lord Privy Seal and the Chancellor of the Exchequer. The powers of the Poor Law Board, and some of those from the Privy Council, were transferred to the new Board (as the Royal Sanitary Commission had recommended); certain functions from the Board of Trade and the Home Office being transferred the following year. The Poor Law Board dominated the new Board, which was to prove rather unfortunate as it perpetuated their tradition of restrictive and negative control. The new Local Government Board became the department which produced the Model By-laws in 1877, and through which official approval was granted for all local by-laws. In passing, it is worth remembering here that an Order in Council made in June 1870 had opened the way for entry by examination - and therefore merit rather than wealth or influence - to the Civil Service in all branches except the Foreign Office. In time this was to raise the standard of work produced by central government, and in our context, the level of competence of the civil servants working for the Local Government Board.

In 1872, after Sir Henry Selwin-Ibbetson's brief but unsuccessful attempt at a Public Health in Rural Places Bill (82), Sir Charles Adderley again sought approval for a new public health and local government bill. Stansfeld told the Commons that this Bill was intended to construct new local sanitary authorities and to introduce new sanitary powers, insisting that the legislation should cease to be the permissive responsibility of the local authority (83). As 'The Builder' noted however, this Bill did not effectively consolidate the existing legislation and it still retained its basically permissive rather than compulsory nature (84). Nevertheless, it was otherwise generally in line with the Royal Sanitary Commission's recommendations. For example, it called for the establishment of Medical Officers of

Health for all local authorities (even though there was not a sufficient number of suitably qualified men available) and, for the first time, it effectively divided the country into urban and rural sanitary districts. It was passed on 10 August 1872 (85).

The Bill had closely followed the Commission's recommendations for rural authorities. By-laws could be made for new buildings, for the dryness of sites, for walls and foundations, and for the ingress and egress to public buildings. But, as the Report had also recommended, the Bill required no notices or drawings to be submitted and nor could a local rural sanitary authority have power to pull down any work done in contravention of the by-law. This, after so much call for effective control was a ridiculous piece of nonsense. 'The Times' took up the point:

"In other words, the by-laws might be made, but it was optional whether to obey them and no power of enforcement would exist. Now, laws are chiefly required to control those who wish to do wrong, and a law which cannot be enforced had better not be enacted. The proposed by-laws would be set at defiance in the construction of buildings which now give the greatest trouble to sanitary authorities - namely, which are enacted just outside urban boundaries, which come within those boundaries in course of time and which surround every great and growing town with a belt of habitations in which the requirements of health and decency are alike left unprovided for. There would be no hardship in requiring the deposit of plans and sections in every case, or in requiring that houses unfit for tenancy should be built. The promoters of the Bill (in 1873) should take counsel together upon this part of their case, for they have touched no evil that calls more urgently for reform" (86).

But the counter pressure from the land was strong, and no rural by-laws were in fact framed at this stage.

The pressure for consolidation of the health laws was maintained throughout 1873. The Local Government Board prepared a useful digest of Sanitary Statutes in January which, since it gathered together all the various strands, formed a sounder basis for the later consolidating legislation. Curiously however, it was not made publicly available, Stansfeld informing the Commons in February that it was complete but that it was considered to be more suitable for private publication, and that a further digest would be prepared (87). This digest was important, being the first attempt to seriously look back and analyse all the existing legislation, and enabling a clearer view to be obtained of all the redundant and overlapping material:



"In preparing the digest, the various sanitary acts had been taken to pieces and re-arranged under practical headings, so that any man without a knowledge of the law could refer to this digest and ascertain what was the law upon the subject, all redundant phraseology having been got rid of" (88).

Sir Charles Adderley noted that the Queen's Speech made no mention of any new sanitary legislation and he questioned the Government's motives. Gladstone, not surprisingly, replied that action would not be immediate (89) and, four days later, in answer to a similar question, Stansfeld replied that he was not sure when any new legislation would be introduced - it depended "on the progress of public business" (90). The pressure continued. On 25 February, Adderley asked Stansfeld if the digest of sanitary codes was so complete as to render any further consolidatory legislation unnecessary, to which Stansfeld replied that he did not think it expedient to consolidate the Sanitary Acts in the present session. Although one minor amending Bill to the 1872 Public Health Act was passed in August 1873 (91) and a further minor one in August 1874 (92) the matter of sanitary legislation remained at a low level for a year. More significant affairs of government were in progress, notably the end of Gladstone's Liberal Government and the emergence of Disraeli's new Conservative government. Disraeli was to have considerably more sympathy than Gladstone with the matter of sanitary reform. It had, after all, been under his first ministry in 1868 that the Royal Sanitary Commission had been established. Although these major political changes occupied the main business of Parliament, the need for sanitary reform was not lost sight of in 1874. The publication of the Local Government Board Report in 1874 drew the attention of The Editor of 'The Times' who wrote in September:

"The laws which the Local Government Board are administering are confessedly at once confused and imperfect, and the time has come when they imperatively need a thorough revision and bold expansion" (93).

The time had indeed come. On 11 February 1875, Mr Sclater Booth asked for leave in the Commons to bring in a new Public Health Bill, to consolidate and amend the existing Acts relating to Public Health in England. He referred to the Royal Sanitary Commission Report, to its reference to the complex and confused nature of the existing sanitary law. This, he explained, was due to the "experimental character" of the legislation, leading to the constant enlarging and extending of the existing acts, with no real attempt at correlation. The digest of

sanitary law of 1873 had helped the Local Government Board officials to administer the existing acts but, although there was no need for any fresh legislation on the subject, there was a strong need for reconciliation to take place between the Acts, and it was only possible to do that by sweeping away the twenty-nine sanitary statutes passed since 1846. Besides consolidation, certain amendments would, he said, be included. These concerned sewers, gas and water provisions, mortuaries, overcrowding of houses and "they also proposed to introduce a few amendments of a technical character, with which he need not now trouble the House" (94). And there, at that point, one or two 'technical' amendments were made which in fact were <sup>to</sup> increase the scope of the building by-laws beyond the limits set in 1858. These are referred to in more detail shortly.

The Bill passed its second reading on April 19, and a Committee reported on it on 25 May, but no special mention was made of streets and buildings, although there was a subsequent amendment on June 3 to clause 153 concerning the powers to regulate the line of buildings, particularly in reference to shop fronts (95). After its third reading on June 7, it went to the Lords. At its second reading there, on June 28, the Duke of Richmond noted that the Bill was neither complete nor conclusive, nor was it designed "as a settlement of the great sanitary questions which had of late been so much discussed" (96). It was fundamentally a consolidating measure, and broke virtually no new ground.

It returned to the Commons, with little comment, although one or two very minor amendments were made to it in August. The Royal Assent was granted on 11 August 1875 (97). The new Act repealed a number of earlier statutes, including the Towns Improvement Clauses Act 1847, the Public Health Act 1848, the Local Government Act 1858, with its later amendments, and the Nuisances Removal, Sewage Utilization and Sanitary Acts (98).

The Public Health Act of 1875 was a major piece of legislation - but not the only piece of legislation in Disraeli's 'annus mirabilis' of domestic reforms (99). It was also the important product of the sincere and hard work of Dr. John Simon. The Act was arranged in a clearer and more logical format than any of the earlier sanitary

statutes. It provided the first "comprehensive and fairly intelligible system of administrative authorities suited to modern requirements" (100). The Urban Sanitary Authority (formed from the Old Town Council, Local Board or Improvement Commissioners) and the Rural Sanitary Authority (formed from the old Board of Guardians) became clearly identified. But it was still only permissive, and a local authority could still evade it altogether if it had its own local act - and London was again still excluded. Nevertheless, in spite of its permissive character, it came at a time when the importance of sanitary controls was more favourably accepted than ever before, and the climate was more healthy so that the new Act now had a stronger chance of taking root and flourishing.

Turning to the contents of the Act itself, the key section as far as we are concerned is Section 157. This provided that every Urban Authority (not Rural, it will be noted) may make by-laws with respect to the following matters:

1. the level, width and construction of new streets and the provision for the sewage thereof,
2. the structure of walls, foundations, roofs and chimneys of new buildings, for securing stability and the prevention of fires and for purposes of health,
3. the sufficiency of space about buildings to secure a free circulation of air and with respect to the ventilation of buildings,
4. the drainage of buildings, to w.c., earth closets, privies, ashpits, cesspools, in connexion with buildings, and the closing of buildings or parts of buildings unfit for human habitation, and to prohibition of their use for such habitation.

Except for the inclusion of earth closets, this section can now be seen to bear little resemblance to the extensions and alterations recommended by the Royal Sanitary Commission (see page 245). But compared with its predecessor in Section 34 of the Local Government Act of 1858, the following changes can be seen. In sub-section 2, the 1875 Act added 'foundations, roofs and chimneys' and 'for the purpose of health'. The early clause had been confined to stability and fire prevention. In sub-section 4, earth closets were added. The other sub-sections, 1 and 3, remained as in the 1858 Act. Section 157 also repeated closely the 1858 Local Government Act that no by-law could affect buildings erected before the Local Government Act came into force, or was in a place not constituted an urban district by order of the Local Government Board. Besides Section 157 however, there were other sections which included further relevant matters. Section 158

gave the local authority one month in which to approve the submitted plans, together with details of the various offences and penalties, and section 159 defined the erection of a new building and the various categories of rebuilding. Sections 153 and 156 related to building lines and sections 71 and 72 restated the controls on cellars. Such was the new framework in which subsequent building regulation was to be set, and the details of its course and operation will be the subject of chapter VI.

\*\*\*

### Towards a National Building Act

The Public Health Act 1875, with the powers it contained for the production of building by-laws by all urban areas, forms both the mid point and watershed of this Thesis. We set out in 1840 with an account of the early moves towards a national building act. Now, after a detailed investigation of the complicated pattern and vicissitudes of building and sanitary legislation over a period of 35 years, we are now at the point where the stage was to be set for the emergence of a far more effective range of local building by-laws throughout the country and, if we exclude for the moment the abortive first attempts in 1858, of the first effective set of national building regulations produced by central government in the form of the Model By-laws.

Throughout this first period there had been a constant call from a variety of sources for some form of a single national set of regulations - to operate at least as a guide which could, as the situation demanded, be modified at local level. The conflict between central and local control, and the possible interference with private property and liberty, and the lack of effective machinery, lay at the root of the reluctance of government to press too hard or too quickly. All legislation was in effect experimental, some failing to stand the course, but each small piece gradually establishing a firmer foothold for the next and, looking at it with hindsight, nearly every piece paved the way for more and more central, rather than local, direction.

We have mentioned earlier the possibility that the Metropolitan Building Act should have been extended to the rest of the country -

which is what Lord Normanby's first bill of 1841 had almost succeeded in doing. The 'Justice of the Peace' journal had made the suggestion again in 1856 (see chapter III page 152). Correspondents to 'The Builder' had made the same suggestion, in 1859 (101) and 1869 (102) for example, and a Select Committee of the House of Commons, in considering fire prevention, had recommended the extension of the Metropolitan Building Act to the rest of the kingdom by some general statute (103). But the blanket imposition of such controls would, as we have seen, have caused considerable resentment with local districts, causing problems of operation since there was no effective local machinery and producing possibly dangerous political consequences. Even London found difficulties in operating its own Act successfully.

Perhaps the clearest statement came from Robert Rawlinson, Chief Inspector of the Local Government Act Office, in a letter to the Home Office dated 11 February 1870 (104). Rawlinson mentions that there was no consolidation Act for the whole country, and that therefore all the local building Acts differ and were imperfect and, as he said, in many districts there were no building by-laws at all. All this came from the one person in the Local Government Act Office who was probably in the best position to see the total picture. The letter was referred to in the evidence of the Royal Sanitary Commission in 1871.

Rawlinson continued:

"A model standard building bill would be of great use, and to frame such a bill, the Metropolitan Surveyors and Medical Officers, with the Borough Surveyors and Medical Officers of Liverpool and Manchester, ought to be consulted. I do not think it practicable or advisable to frame and enact a General Building Act, as there are local peculiarities and requirements necessary in one place or district which would not apply in other places. But a consolidated general Building Act, consisting of model clauses, on the same plan as the Consolidated Clauses Act, would be most useful, and is much wanted, and I know of no more useful measure that could be set about".

The Commission agreed with Rawlinson's opinion that a General Building Act was not possible - principally because:

"while descending into details it must also adapt itself to the peculiar needs of each place (however it may vary from other places in its local circumstances) or even the peculiar needs of different parts of the same place. Such requisites, even if constant, it would be very difficult to combine and satisfy in an Act of Parliament, but it is further to be noticed, that if by-laws are to be of a discriminating kind, and really to adapt themselves to the special needs of a place, they will call for modification from time to time as

the circumstances of the locality become modified. But statutory enactments admit of no adaptations as they cannot be varied except by the legislature" (105).

This would therefore seem to mark the end of the Building Act as a statutory measure for new national application (though of course they were maintained in London and Liverpool) and, recognizing correctly the need for flexibility, the by-law form was to be retained for building regulation for the future. Even London itself followed this direction in the 1880's, when it produced by-laws for detailed controls under the broader scope of its Building Act. Model Act clauses, such as the Towns Improvement Clauses Act, were too rigid and no longer suitable.

In spite of the Commission's support for the by-laws, there were still calls for some form of national statute, even after the publication of their report. Dr. Liddle, that veteran campaigner for sanitary reform, said in 1873:

"that in consequence of numerous unhealthy houses which are continually being built in the suburbs of London, and also in other large cities and towns, and the suburbs thereof, the area of the new Building Act shall be extended to all large towns and populous cities in England... ." (106).

The following year, and just one year away from the Public Health Act, Baldwin Latham was to observe that:

"the question was a very much larger one than that of merely applying a certain Act of Parliament to the Metropolis. There were many large towns and country places that equally required a Building Act ... the sweeping away of the by-laws which now regulate the construction of buildings, the passing of an Act of Parliament applicable to all parts of the country, regulating their stability, the means for the prevention of the spread of fire and their sanitary requirements, would be a great boon to the country at large" (107).

The theme was even taken up by the legal profession itself, as this quotation from the 'Law Magazine' in 1873 makes clear.

"The desirability of establishing some central authority, say the Local Government Board, which shall have absolute control over the construction of all buildings in the Metropolis and elsewhere, is every day being more and more felt". [This absolute control everywhere would surely imply a national statute]. "This Board should have a sufficient number of inspectors to see that the details and regulations as to the construction of buildings, both structurally and sanitary, are implicitly carried out in all parts of the country, [a national inspectorate of this scale would have been both novel and controversial] and that in the new Public Health Act, provision should be made for the structural requirements, and a

schedule attached to the Acts, regulating the use of materials in various districts [in fact, this could be more easily accommodated, in by-laws]. However, before such a general measure can be passed, it would be well for a Government Commission to be issued, having power to take evidence in various parts of the country, as to the requirements necessary to meet particular cases, more especially with regard to the use of local materials. That the power of the Local Boards to make by-laws for the regulation of buildings should cease, and that the officers appointed under the Board should be competent to supervise the structural and sanitary requirements of building is clear. At present, the by-laws of Local Boards are rarely, if ever, put in force where they are most required. Either those most interested where building operations are prosecuted are sufficient to deter the local authority enforcing the by-laws, or the by-laws have been prepared by persons interested in building operations, and consequently they have not sufficient scope to deal with the proper structural and sanitary arrangement of a building. It seems a very great anomaly that just outside the Metropolitan Building Area, where building operations are being prosecuted to a far greater extent than within that area there are districts in which there are no by-laws for building, the sanitary authorities or vestries having no by-laws or regulations, and it is an equal anomaly that within a certain line, fees should be taken, and that without that line, persons are not called upon to pay fees for supervision that is necessary for the protection of the public" (108).

This latter part is a reference of course to the fee-paying arrangements to the London District Surveyor - a system which could not be operated outside London under the Public Health and Local Government Acts .

There was a great deal of sense in these views expressed by the lawyers and had it been possible to obtain agreement in all quarters, something closer to a national set of building regulations might have been possible in 1875. But this was not to be - the change in attitudes and the necessary machinery were not available, and the local by-law system continued to receive official support.

\*\*\*

The prelude to the Public Health Act of 1875 and its consequences in establishing the framework for a more extensive and national pattern of building regulation, through the subsequent Model By-laws of 1877, is the most important development of this chapter. But without wishing to detract from this importance, there are a number of other significant points which have arisen in the course of the chapter which may be appropriately re-emphasised here by way of conclusion.

The first is the very existence of the earlier Form of By-laws in 1858. This document has, surprisingly, received little attention elsewhere in accounts of the building by-laws. It seems to be generally assumed that the 1877 set was the first model code, and the 1858 set, which is certainly more limited in its scope, has been somewhat overshadowed by the better known set of 1877. This balance needs to be adjusted. The 1858 Form, tentative as it was, is the important link between the London regulations embodied in the Metropolitan Building Act of 1855 and the Model By-laws of 1877. Furthermore, a number of towns appear to have modelled their own by-laws on this 1858 Form, and whilst in many cases they were not elaborate and suffered in their administration from mismanagement, there were occasions and Bradford may be one, where they were apparently elaborated beyond the minimum suggested by the Local Government Act Office.

Secondly, within the technical nature of the controls themselves, we should note further examples of the more sophisticated 'relationship controls', such as we have already seen in the relationship of street width and building height. The relation of a ceiling height to the area of a room in the attic is one, the area of a window being related to the area of a room is another, the distance across a backyard related to the height or number of storeys in the adjacent building is yet another. They nearly all related, incidentally, to matters concerning health - that more subjective area of control mentioned at the end of chapter I. These controls showed some acceptance of the fact that there are variable and inter-related elements in a building. They also reflected the realisation that building was susceptible to change and variation. The result was the acceptance of the by-law, rather than the Act, as the better means of obtaining a more responsive control. The by-law was capable of incorporating local factors in its formation and application, and was capable of being more quickly altered to meet new and changing demands - without recourse to the full and slow machinery necessary to alter statute law. Whilst admitting the possibility of local variation, the local by-law did at the same time tend to run contrary to any national building measure and to lose the possible benefits of uniformity and consistency.

Finally we may have learnt something from Joseph Boult and his inter-



pretation of the Building Acts. Building construction is a progressive art and it does need discretion in its interpretation. It cannot be too rigidly specified for any length of time, and it is therefore immediately at variance with the rigid specification inherent in so much legislation. Furthermore, as the regulations developed, they seem to have moved almost without question from the smaller scale of the domestic building to the larger scale associated with the newer and more specialised building types, with all their new problems and complexities. This may be another cause of the current malaise in modern building regulation. The production of a large number of generalised rules in an attempt to cover the complexities of a particular and specialised building type has led to endless problems of interpretation and control. Had the regulations stayed within the smaller scale of the domestic field, and larger buildings been left to the discretion of the Surveyor - such as was the case with the District Surveyor in London - a more satisfactory state of affairs might have resulted.

In the following chapter we stay with the provincial developments and continue with an analysis of the 1877 model by-laws themselves. The watershed formed by the achievement of the Public Health movement is passed and we concentrate in more detail on the emerging building regulations themselves.

\*\*\*\*\*

NOTES TO CHAPTER V

- 1 21 and 22 Vic.cap.98.
- 2 11 and 12 Vic.cap.63.
- 3 First annual Report by the Secretary of State for the Home Department to Parliament on the execution of the Local Government Act 1858. p.p. 1859 XI. second series, p.156.
- 4 "Forms of By-laws prepared in the Local Government Act Office and issued to Local Boards of Health under the Public Health Act 1848 and Local Boards established under the Local Government Act 1858". Appendix (C) First annual Report (as note 3 above) and pp 30 et seq.
- 5 Report of Royal Commission Enquiry into State of Large Towns and Populous Districts 1844-5 Recommendation, no.23.
- 6 Select Committee Report on the Regulation of Buildings and Improvement of Boroughs 1842 P.P. 1842 Vol.X. Evidence of Lawrence and Kelsey, para.1023. Fourth Rate house = 50 sq.ft., Third Rate house = 70 sq.ft., Second Rate house = 100 sq.ft., First Rate house = 150 sq.ft.
- 7 B.Vol.18 No.928 17 Nov. 1860 p.740.
- 8 J.Hole, "The Homes of the Working Class" London, 1866, p.36.
- 9 Ibid. p.39.
- 10 Ibid. p.38.
- 11 Ibid. p.111 (and see Table 7, sheet 5)
- 12 B.Vol.23 No.1145 14 Jan. 1865 p.35.
- 13 B.Vol.24 No.1235 13 Oct. 1866 p.768.
- 14 B.Vol.29 No.1459 21 Jan. 1871 p.43.
- 15 Royal Sanitary Commission, First Report, 1869. Evidence of Notcutt, para. 1413-5.
- 16 Ibid.
- 17 Waite v. Garston Local Board of Health, 1867. 37 L.J., new series, Magistrates cases 19; and J.P. 1867. Vol.31 p.724.
- 18 Hattersley v. Burr 1866 14 L.T., new series, p.565.
- 19 Burgess, v. Peacock 16 C.B., new series, p.624 and 10 L.T., new series, p.617.
- 20 Young v. Edwards, 11 L.T., new series, p.424.
- 21 W.C.Glen, "Law relating to Public Health" Fourth Edition, London, 1866, p.207.
- 22 Sheil v. Sunderland 6 H & N (796); 30 L.J., new series, Magistrates cases 215.
- 23 Tucker v. Rees 7 Jur. new series 629. J.P., Vol.26.
- 24 Anderton v. Birkenhead. 9 Jur. new series 1058; 32 L.J., new series, magistrates cases. 137.
- 25 17 and 18 Vic.cap.101.
- 26 Pearson v. Kingston upon Hull. 13 L.T., new series 180; 3 H & C 921 35. Law Journal magistrates cases 36 and J.P., Vol.29 p.695 and Vol.30 p.51.
- 27 B.Vol.22 No.1113 4 June 1864 p.419.
- 28 Manchester building by-laws 1867 nos. 17,13 and 18.
- 29 B.Vol.25 No.1272 22 June 1867 and No.1294 23 Nov. 1867 p.850.
- 30 B.Vol.30 No.1556 30 Nov. 1872 p.953.
- 31 B.Vol.31 No.1586 28 June 1873 p.506.
- 32 B.Vol.33 No.1695 31 July 1875 p.692.
- 33 17 and 18 Vic.cap.xv.
- 34 21 and 22 Vic.cap.80.
- 35 24 Vic.cap.42.

- 36 J.Boult, "Remarks on the Liverpool Building Act". A communication to the Liverpool Architectural and Archaeological Society, 1856.
- 37 Ibid.
- 38 B.Vol.18 No.888 11 Feb. 1860 p.92.
- 39 27 and 28 Vic.cap.73. (23 June 1864).
- 40 B.Vol.25 No.1296 7 Dec. 1867 p.833.
- 41 See Iain C.Taylor, "The Insanitary Housing question and tenement dwellings in nineteenth century Liverpool" in "Multi-story - the British working class experience" Edited by A.Sutcliffe, London, 1974.
- 42 A.Errazurez, "Some types of housing in Liverpool 1785-1890" Town Planning Review, Vol XIX, 1946, p.64.
- 43 B.Vol.27 No.1395 30 Oct. 1869 p.863.
- 44 B.Vol.28 No.1428 18 June 1870 p.477.
- 45 24 and 25 Vic.cap.61.
- 46 B.Vol.20 No.1000 5 Apr. 1862 p.249.
- 47 26 and 27 Vic.cap.17.
- 48 27 and 28 Vic.cap.68.
- 49 23 and 24 Vic.cap.77 and 26 and 27 Vic.cap.117 respectively.
- 50 28 and 29 Vic.cap.75.
- 51 30 and 31 Vic.cap.113.
- 52 29 and 30 Vic.cap.90.
- 53 The Times, 11 Aug. 1866 p.8 col.e.
- 54 31 and 32 Vic.cap.115.
- 55 Royal Sanitary Commission, Second Report, 1871, p.11.
- 56 Summary from J.Redlich and F.W.Hirst 'Local Government in England' London, 1903. Vol.I, p.152.
- 57 Royal Sanitary Commission, First Report, 1869, para. 1413.
- 58 Ibid. Second Report, 1871, paras. 2374, 2399, 2375-2402.
- 59 Ibid. Ibid. para. 2213.
- 60 Ibid. Ibid. para.940.
- 61 E.Gauldie, "Cruel Habitations", London, 1974. This work gives an account of the rural housing conditions at this time.
- 62 Royal Sanitary Commission, Second Report, 1871, para.1159.
- 63 Ibid. para.6575
- 64 Ibid. para.7490
- 65 Ibid. para.4867 and First Report, p.xxix.
- 66 Ibid. para.2936.
- 67 Ibid. para.7096 and 7141.
- 68 Ibid. para.7490 and for Denton's own by-laws see First Report, p.xxix.
- 69 Ibid. para.8481.
- 70 B.Vol.29 No.1470 8 Apr. 1871 p.257.
- 71 Royal Sanitary Commission, Second Report, 1871, p.47
- 72 Ibid. para. 1765.
- 73 Ibid. p.47.
- 74 Ibid. p.51-53.
- 75 Ibid. p.113.
- 76 Set by section 35 of Local Government Act 1858 and Section 28 of Local Government Amendment Act 1863.
- 77 32 and 33 Vic.cap. xxx sec.141 (1869).
- 78 B.Vol.29 No.1462 11 Feb. 1871 p.113.
- 79 H.Jephson, "The Sanitary Evolution of London", London, 1907, p.235.
- 80 H.Vol.208 p.234 1871.
- 81 34 and 35 Vic.cap.70.
- 82 Introduced 7 Feb.1872, withdrawn 24 Apr. 1872.
- 83 B.Vol.30 No.1516 24 Feb. 1872 p.143.

- 84 B.Vol.30 No.1520 23 Mar. 1872 p.219.
- 85 35 and 36 Vic.cap.79.
- 86 The Times, 29 Dec. 1873 p.7 col.d.
- 87 H.Vol.214 p.154 7 Feb. 1873.
- 88 H.Vol.215 p.895 25 Feb. 1873 and Local Government Board Second Annual Report, 1872-3. P.P. 1873, xxix p.lii.
- 89 H.Vol.214 p.198 10 Feb. 1873.
- 90 H.Vol.214 p.373 13 Feb. 1873.
- 91 36 and 37 Vic.cap.73 (5 Aug. 1873).
- 92 37 and 38 Vic.cap.89 (7 Aug. 1874).
- 93 The Times, 22 Sept. 1874 p.7 col.b.
- 94 H.Vol.222 p.232.
- 95 H.Vol.224 p.1359 3 June 1875.
- 96 H.Vol.225 p.638.
- 97 38 and 39 Vic.cap.55.
- 98 see Schedule V to the Public Health Act 1875.
- 99 Also the Artizan's Dwelling Act, the Trade Union Act and the Sale of Food and Drugs Act.
- 100 J.Redlich and F.W.Hirst op.cit. Vol.I, p.155.
- 101 B.Vol.17 No.873 29 Oct. 1859 p.718.
- 102 B.Vol.27 No.1361 6 Mar. 1869 p.194.
- 103 The Times, 16 Aug. 1867 p.7 col.b.
- 104 Royal Sanitary Commission, Second Report, 1871 : Appendix.
- 105 Ibid. p.52.
- 106 B.Vol.31 No.1564 25 Jan. 1873 Liddle to Social Science Association on the "Defects in the sanitary provisions of the Metropolitan Building Act", Item 16.
- 107 B.Vol.31 No.1565 1 Feb. 1873 p.88-9.
- 108 B.Vol.31 No.1568 22 Feb. 1873 p.152.
-

under Local Government Act 1858 : 21 and 22 Vic.cap.98  
sect.34

DATE : November 1858

SOURCE : First Annual Report by the Secretary of State for the  
Home Department to Parliament on the execution of the  
Local Government Act 1858.

P.P. 1859 Vol.XI 2nd. series p.156 and appendix (c)  
pp 30 et seq.

Reference in text : page 226

	SELECTED CLAUSES relating to building design and construction Summary of contents	LINKS	
		ANTE	POST
1	Carriage road = 36'0" min.width. Local Board to determine footpath and carriageway widths within that width. Non-carriage road = 18'0" min.width. One entrance at least, full width of street and open from ground upwards. (If such street over 100'0" long, Local Board has option to determine whether or not it is a carriage road).	see text page 226	T8.c4 and T8.c7
		T4.ScI	T8.c8
			T8.c5
		new	-
		(T4.ScI specified width to be between houses)	T8.c6
2	Reductions to widths allowed if a) open space in front of houses alongside street or b) if street is not the principal or only approach to houses. (Width = whole space dedicated to public exclusive of steps or projections and measured at right angles to course or length of street).	T4.ScI (see also T6.s1)	T14.c47-c49
3	Height of buildings not to exceed width of street. (Height taken from centre of street opposite building up to parapet or eaves).		
4	Local Surveyor to specify all details for sewers etc for drainage of street and adjacent properties.		
5	Construction and materials for street to be approved by Local Board.		
<b>STRUCTURE</b>			
6	Wall thickness - as approved by Local Board. Foundations - on solid ground or concrete or other solid substructure.	T6.c1	T8.c9 and T8.c16
		as above and T6.c2	T8.c11
7	External, party and side walls to be of brick, stone or other hard and incombustible substance although Local Board may allow alternative if they expect no danger from spread of fire.		

8	Party and external wall above roof - to be not less than 12" high, at right angles to slope of roof.	T6.c17 and T5.c109	T8.c25 and c26
9	No joists, woodwork, etc, in any external or party wall (except beams, bressummers and storey posts and door and window frames to shops) nearer than 4" to external face of wall.	T6.c14	T8.c24
10	Roof, flat, gutter, dormer, etc, except window and door frames for dormer etc, to be covered externally with incombustible materials.	T6.c19	T8.c52
11	Chimneys and flues to Local Board approval. Hearths and slabs bedded in incombustible material. No timber nearer than 9" to inside of flue - unless brick or stonework is properly rendered. No wooden plugs nearer than 6" to inside of flue. No openings in flue, no pipe for smoke, heated air, steam, hot water, except as approved by the Local Board.	T6.c20	T16.c5  T8.c48
		T6.c20	T8.c48
		T6.c11	T8.c50
12	Exempted buildings - prisons, asylums, court buildings, railway and dock buildings. All buildings, not public, not over 30'0" high, not over 125,000 cu. ft., at least 30'0" from opposite side of the street and at least 30'0" from building or land of adjoining owner. All buildings, not over 216,000 cu.ft not public at least 50'0" from opposite side of street and at least 50'0" from buildings or land of adjoining owner.	T6.s7  see also diagram on T7.s4	T8.c2
13	SPACE ABOUT BUILDINGS FOR VENTILATION Yard area, 150 sq.ft. at rear or side and exclusively belonging to the house. Distance across = 10'0" min. 15'0" min. if house is 2 storeys. 20'0" min. if house is 3 storeys. 25'0" min. if house is over 3 storeys high. (above may be modified by local board).	T6.c29	T8.c54
		new	T8.c54
14	Such open space (as indicated above) never to be built on without Local Board approval.		

26	No house to be occupied until drainage completed and approved - and certificate of completion issued by Local Board.	T6.c75	
----	--	--------	--

Notes

1. Building line - now under Section 35 of Local Government Act 1858.
2. Cellars - now under Public Health Act 1848 (to be read in conjunction with Local Government Act 1858)

DIAGRAM OF COMPARATIVE REGULATIONS FOR EXEMPTED BUILDINGS

	Form of By-laws 1858 cl.12	Metropolitan Building Act 1855
125,000 cu.ft. max. size not public not over 30'0" high		
216,000 cu.ft. max. size not public		

TABLE OF OPEN SPACE PROVISION TO EACH HOUSE IN BUILDING BY-LAWS

From the Bradford Report on Building by-laws  
Quoted in J.Hole, 'The Homes of the Working Classes...' 1866

TOWN	No of STOREYS IN HOUSE	AREA OF OPEN SPACE REQUIRED	DISTANCE ACROSS
BRADFORD	1	150 sq.ft.	10'0"
	2	180	12'0"
	3	225	15'0"
BANGOR BRIGHTON BARNSELY DERBY DONCASTER DOVER GRIMSBY LEICESTER PLYMOUTH	1 2 3 over 3	150 sq.ft. " " "	10'0" 15'0" 20'0" 25'0" (all based exactly on the Form of By-laws of 1858)
BOLTON	1	150 sq.ft.	10'0"
	2	"	12'0"
	3	"	15'0"
BRADFORD near MANCHESTER	1	80 sq. ft.	10'0"
	2	"	15'0"
	3	"	25'0"
CARDIFF	Four parts unbuilt on to five parts built on		
COVENTRY	1	Breadth of building x 40'0" across	
	2 and over	Breadth of building x 60'0" across	
DARLINGTON	2 or 3 room houses	Two-thirds of entire area of ground floor	
	larger houses	One half of entire area of ground floor	
SUNDERLAND	One third of entire area of ground on which the house shall stand		

NOTES

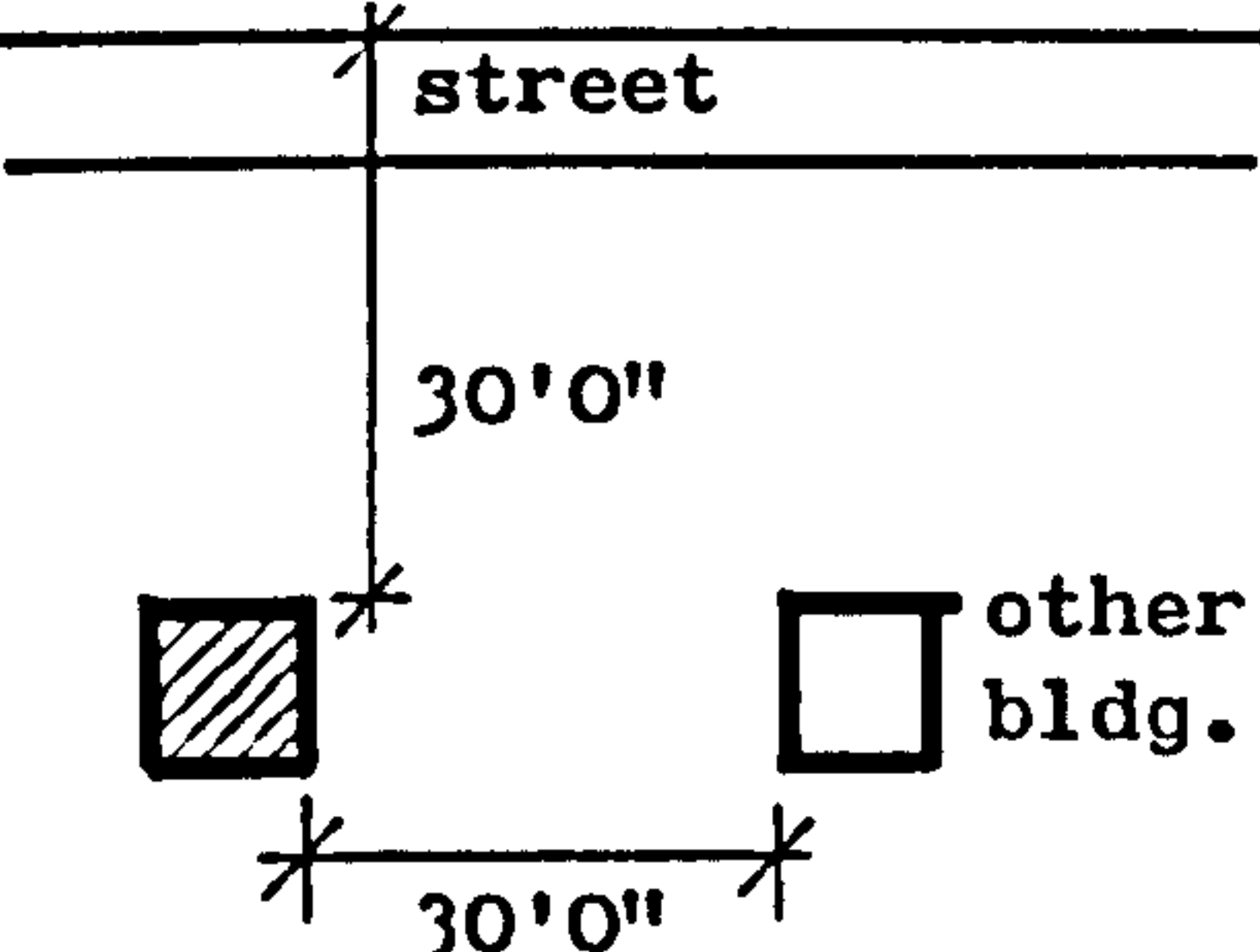
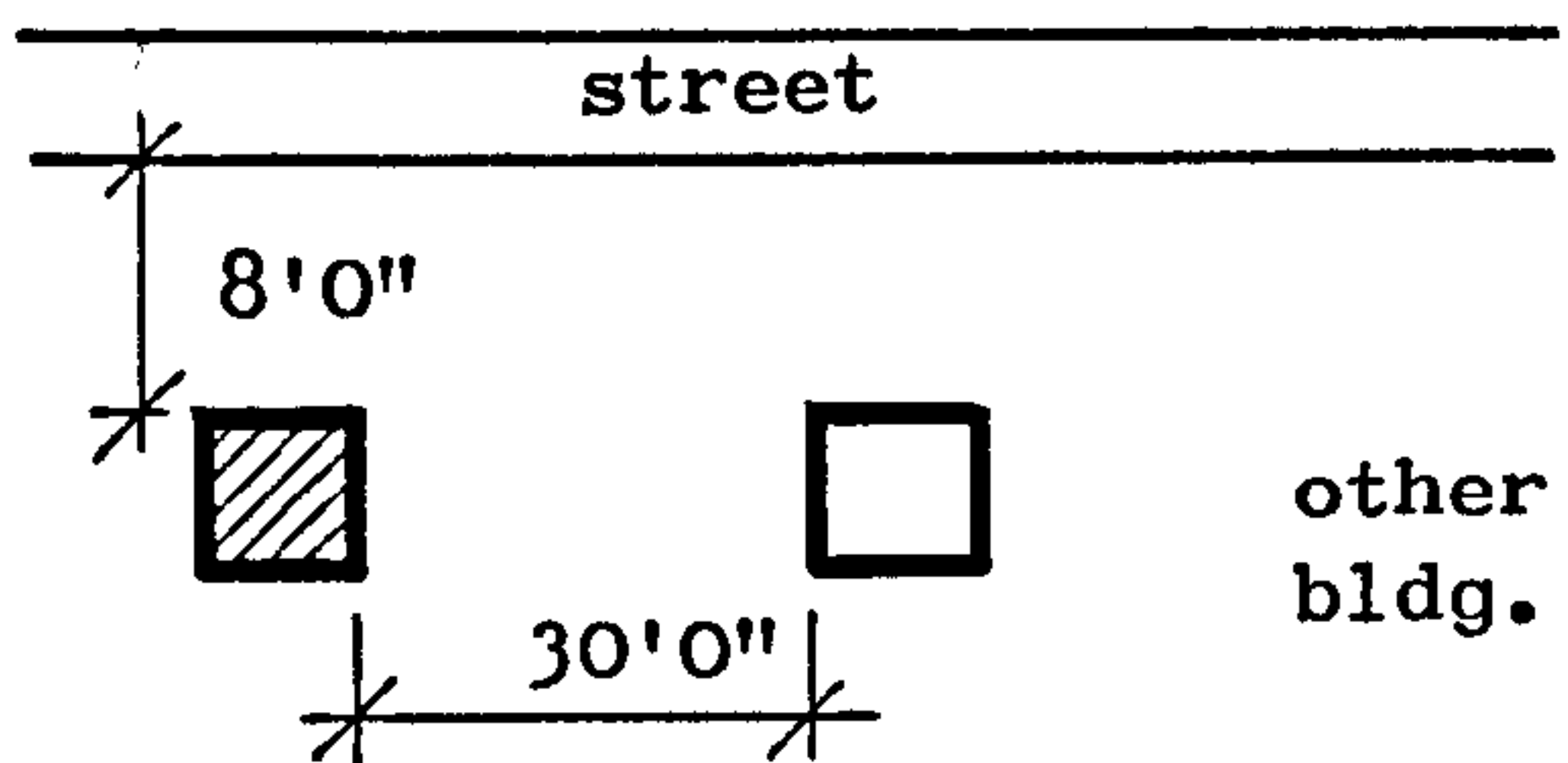
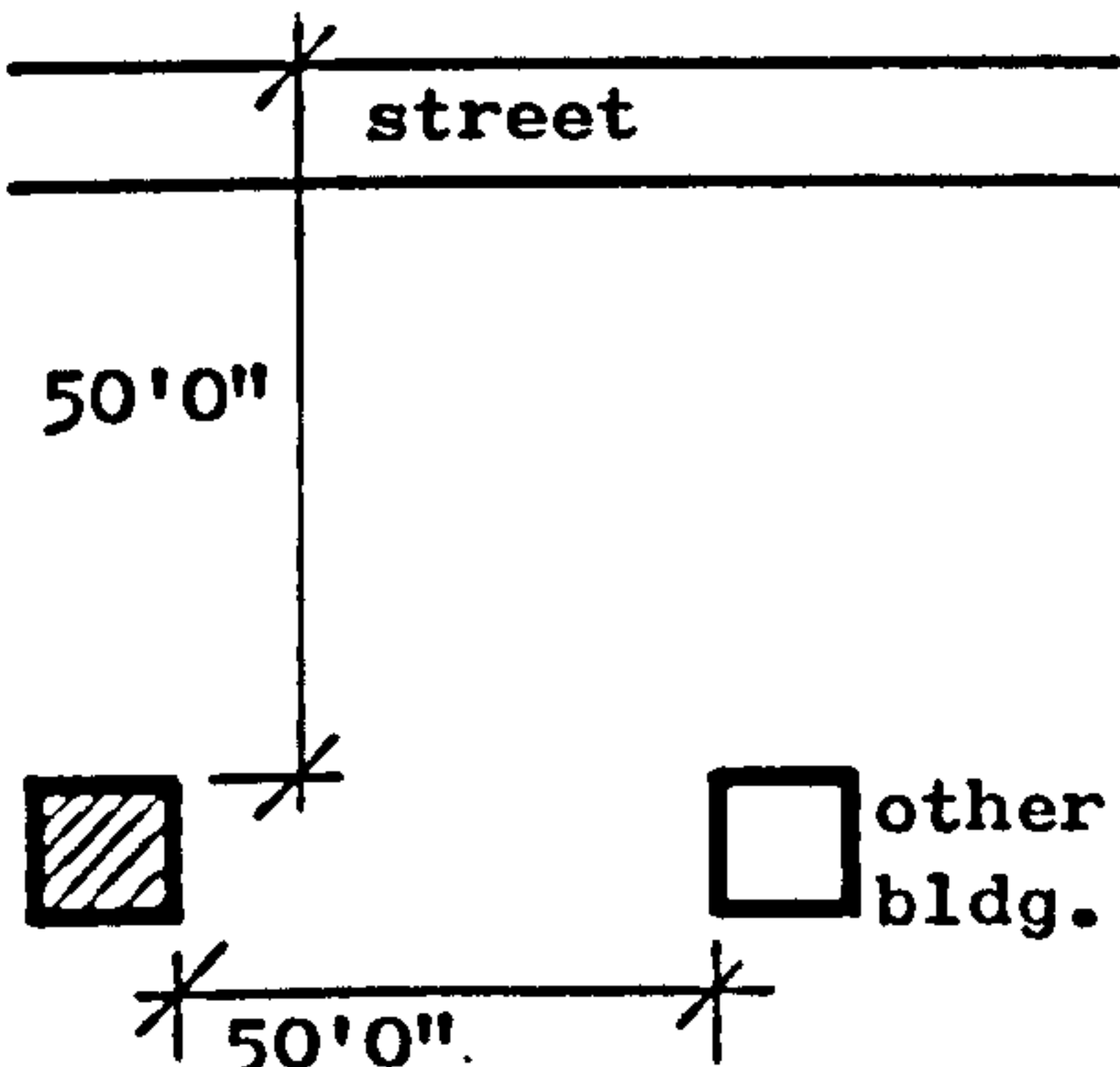
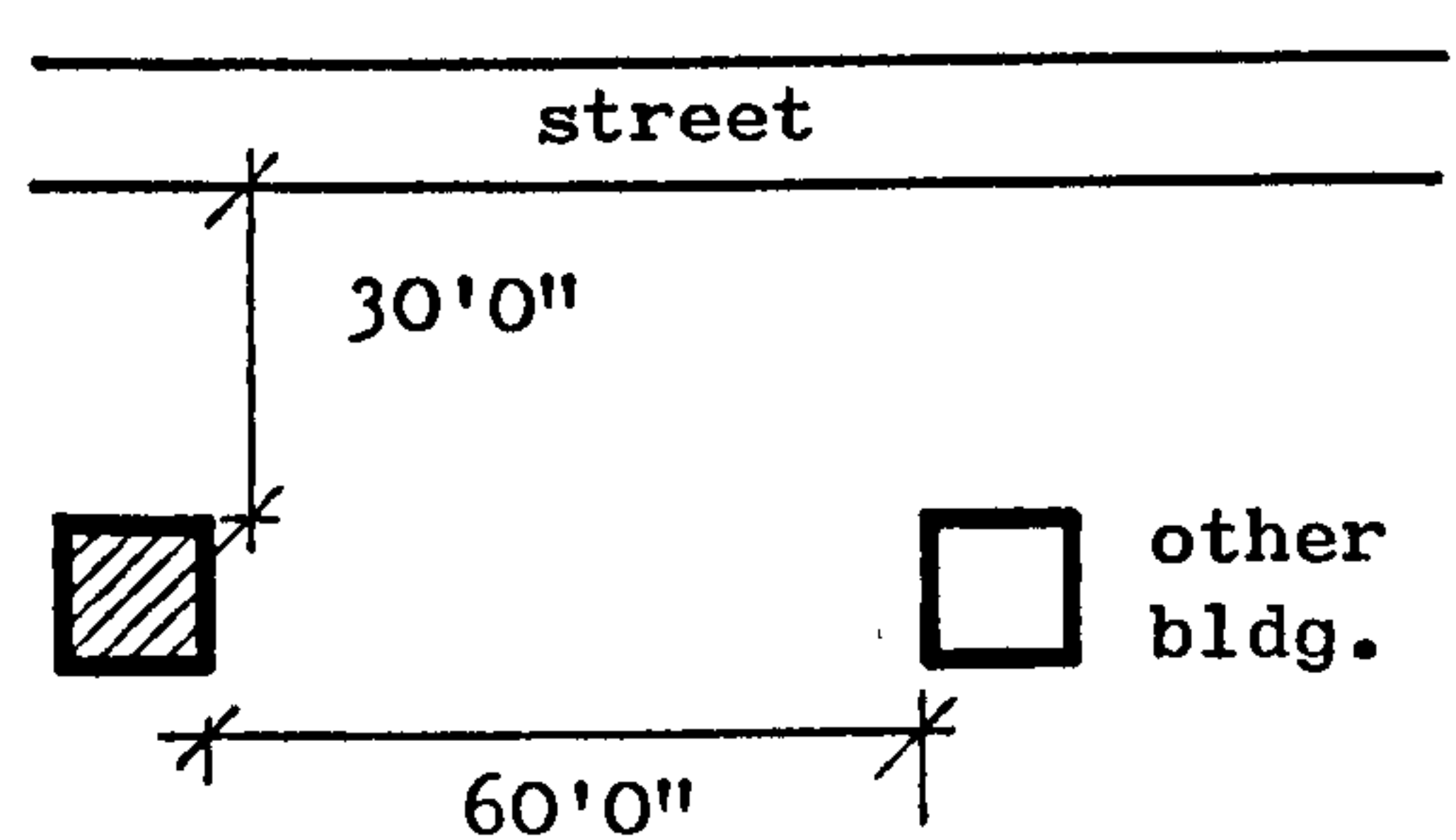
- Further examples which may be added here, although not in the original list above are:  
 HULL 8'0" wide x the length of the house (1854 Act)  
 MANCHESTER 70 sq.ft. (1867 By-law)  
 LONDON 100 sq.ft. (1855 Act)  
 SHEFFIELD 1864 By-laws had the same standard as the 1858 Form of By-laws, with the proviso that they could be modified if they caused "considerable sacrifice of property".